

R761253

Report 3868

MIT LIBRARIES



3 9080 02753 7494

V393  
.R46

# NAVAL SHIP RESEARCH AND DEVELOPMENT CENTER

Bethesda, Maryland 20034



RESPONSE PREDICTIONS OF HELICOPTER LANDING PLATFORM FOR THE USS BELKNAP (DLG-26) AND  
USS GARCIA (DE-1040)-CLASS DESTROYERS

## RESPONSE PREDICTIONS OF HELICOPTER LANDING PLATFORM FOR THE USS BELKNAP (DLG-26) AND USS GARCIA (DE-1040)-CLASS DESTROYERS

by

Susan Lee Bales  
William G. Meyers and  
Grant A. Rossignol



APPROVED FOR PUBLIC RELEASE: DISTRIBUTION UNLIMITED

SHIP PERFORMANCE DEPARTMENT  
RESEARCH AND DEVELOPMENT REPORT

July 1973

Report 3868

The Naval Ship Research and Development Center is a U. S. Navy center for laboratory effort directed at achieving improved sea and air vehicles. It was formed in March 1967 by merging the David Taylor Model Basin at Carderock, Maryland with the Marine Engineering Laboratory at Annapolis, Maryland.

Naval Ship Research and Development Center  
Bethesda, Md. 20034

### MAJOR NSRDC ORGANIZATIONAL COMPONENTS

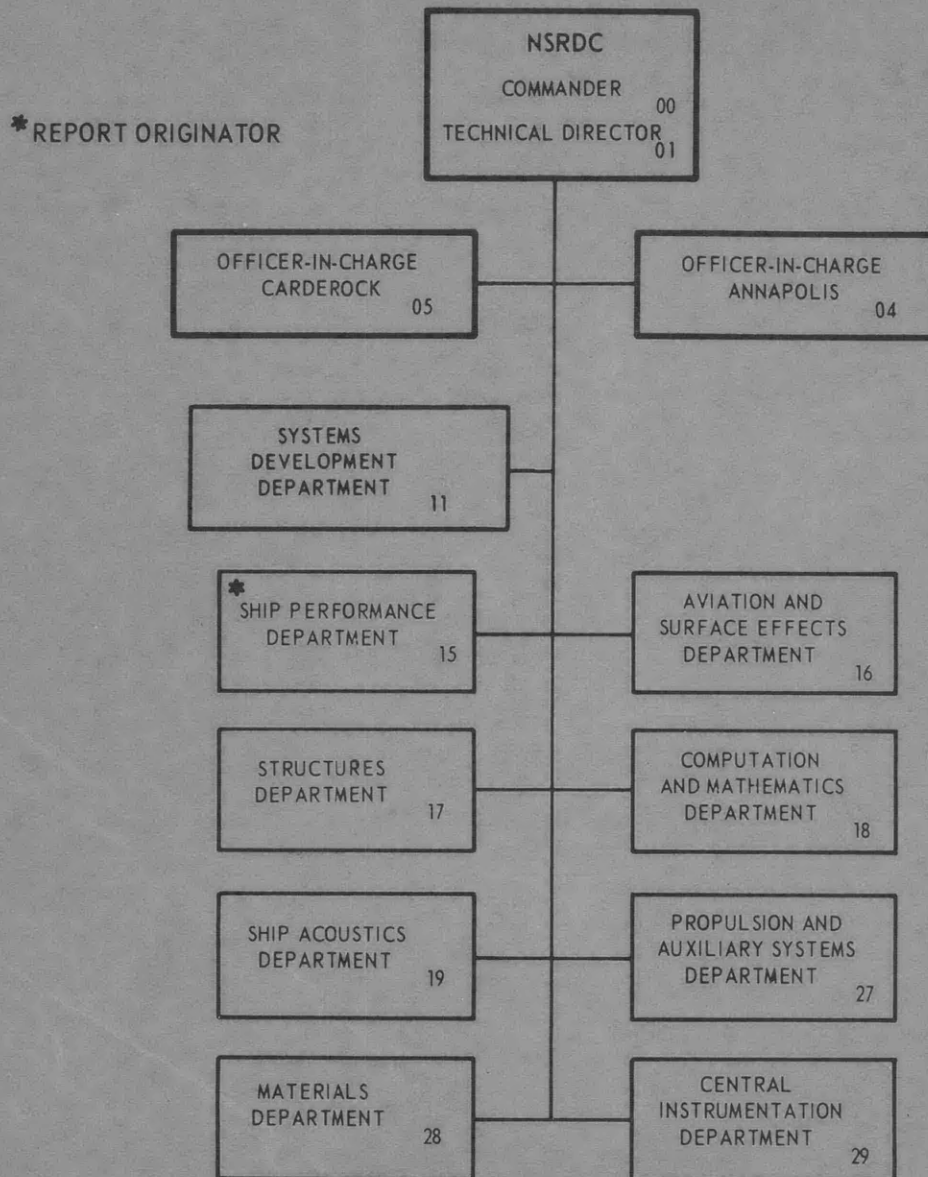

DEPARTMENT OF THE NAVY  
NAVAL SHIP RESEARCH AND DEVELOPMENT CENTER  
BETHESDA, MARYLAND 20034

RESPONSE PREDICTIONS OF HELICOPTER LANDING PLATFORM  
FOR THE USS BELKNAP (DLG-26) AND  
USS GARCIA (DE-1040)-CLASS DESTROYERS

by

Susan Lee Bales  
William G. Meyers and  
Grant A. Rossignol



APPROVED FOR PUBLIC RELEASE: DISTRIBUTION UNLIMITED

July 1973

Report 3868

## TABLE OF CONTENTS

	Page
ABSTRACT . . . . .	1
ADMINISTRATIVE INFORMATION . . . . .	1
INTRODUCTION . . . . .	1
SHIP PARTICULARS . . . . .	2
PREDICTION OF SHIP RESPONSES IN REGULAR WAVES . . . . .	3
GENERAL DESCRIPTION . . . . .	3
ROLL RESPONSE . . . . .	4
SURGE, SWAY, AND YAW IN QUARTERING AND FOLLOWING WAVES . . . . .	5
PREDICTION OF SHIP-RESPONSE STATISTICS IN IRREGULAR SEAS . . . . .	6
GENERAL DESCRIPTION . . . . .	6
FREQUENCY-RESPONSE FUNCTIONS AT AN ARBITRARY POINT . . . . .	8
IRREGULAR SEA REPRESENTATION . . . . .	9
SPECTRAL CLOSURE . . . . .	10
RESULTS . . . . .	11
DATA BASE OF PLATFORM RESPONSES FOR USS BELKNAP (DLG-26) AND USS GARCIA (DE-1040) . . . . .	11
LANDING PLATFORM AND SHIP-RESPONSE LEVELS . . . . .	12
EVALUATION OF DATA . . . . .	12
CONCLUDING REMARKS . . . . .	14
APPENDIX A – PROBABILITY OF OCCURRENCE . . . . .	41
APPENDIX B – ROLL REDUCTION OF USS GARCIA (DE-1040) BY ACTIVE STABILIZING FINS . . . . .	43
APPENDIX C – SUMMARIES OF INVESTIGATIONS . . . . .	47
REFERENCES . . . . .	90



## LIST OF FIGURES

	Page
Figure 1 – Computer Fit of USS BELKNAP (DLG-26) Body Plan . . . . .	16
Figure 2 – Computer Fit of USS GARCIA (DE-1040) Body Plan . . . . .	17
Figure 3 – Location and Size of Bilge Keels on BELKNAP and GARCIA and Location of Fin on GARCIA . . . . .	18
Figure 4 – Stabilizing Fin for GARCIA . . . . .	19
Figure 5 – Location and Size of Helicopter Landing Platform on BELKNAP and Location of Points for which Responses Were Predicted . . . . .	20
Figure 6 – Location and Size of Helicopter Landing Platform on GARCIA and Location of Points for which Responses Were Predicted . . . . .	21
Figure 7 – Right-Handed Coordinate System for Response Predictions . . . . .	22
Figure 8 – Incident-Wave Directions with Respect to Ship . . . . .	23
Figure 9 – Comparison of Measured and Predicted Roll Response in Regular Beam Waves for a Destroyer Hull . . . . .	24
Figure 10 – Percentage Differences Between Roll Predictions at Wave Steepnesses 1/80 and 1/50 and 1/80 and 1/110 for the USS BELKNAP (DLG-26) in Irregular Seas . . . . .	25
Figure 11 – Pierson and Moskowitz Sea Spectra for Significant Wave Heights of 4, 10, 16, and 20 Feet . . . . .	26
Figure 12 – Typical Response Spectrum and its Components for Vertical Displacement of Point 5 on BELKNAP for Significant Wave Height of 10 Feet and Ship Speed of 20 Knots . . . . .	27
Figure 13 – Comparison of Highest Expected Longitudinal Displacement, Single Amplitudes, in 100 Cycles for Origin of BELKNAP and Point 5 with Significant Wave Height of 10 Feet . . . . .	28
Figure 14 – Comparison of Highest Expected Lateral Displacement, Single Amplitudes, in 100 Cycles for Origin of BELKNAP and Point 5 with Significant Wave Height of 10 Feet . . . . .	29
Figure 15 – Comparison of Highest Expected Vertical Displacement, Single Amplitudes, in 100 Cycles for Origin of BELKNAP and Point 5 with Significant Wave Height of 10 Feet . . . . .	30
Figure 16 – Comparison of Highest Expected Roll, Single Amplitudes, in 100 Cycles for BELKNAP and GARCIA with Significant Wave Height of 10 Feet . . . . .	31
Figure 17 – Comparison of Highest Expected Pitch, Single Amplitudes, in 100 Cycles for BELKNAP and GARCIA with Significant Wave Height of 10 Feet . . . . .	32
Figure 18 – Comparison of Highest Expected Longitudinal Velocity, Single Amplitudes, in 100 Cycles for BELKNAP and GARCIA with Significant Wave Height of 10 Feet . . . . .	33
Figure 19 – Comparison of Highest Expected Lateral Velocity, Single Amplitudes, in 100 Cycles for BELKNAP and GARCIA with Significant Wave Height of 10 Feet . . . . .	34

Figure 20 – Comparison of Highest Expected Vertical Velocity, Single Amplitudes, in 100 Cycles for BELKNAP and GARCIA with Significant Wave Height of 10 Feet . . . . . 35

Figure 21 – Comparison of Highest Expected Vertical Velocity, Single Amplitudes, in 100 Cycles for BELKNAP and GARCIA at Point 5 and 20 Knots . . . . . 36

Figure 22 – The Probability  $P$  of  $X$  Exceeding  $b$ , Given  $\sigma$  . . . . . 37

Figure 23 – Nondimensional Roll-Decay Coefficient of GARCIA . . . . . 38

Figure 24 – Percentage of Roll Reduction for Stabilized GARCIA and Experimental Comparison with Two Other Ships . . . . . 38

Figure 25 – Comparison of Highest Expected Roll, Single Amplitudes, in  $N$  Cycles for GARCIA with and without Roll Reduction for 30 Knots and a 120-Degree Heading Angle . . . . . 39

**LIST OF TABLES**

Table 1 – Ship Particulars . . . . . 2

Table 2 – Location of Helicopter Landing-Platform Points for which Responses Were Predicted . . . . . 3

Table 3 – Single Amplitude Statistical Constants for a Fully Developed Wind-Generated Sea . . . . . 7

Table 4 – Definition of State of Sea . . . . . 10

Table 5 – Description of Data-Base Presentation . . . . . 11

Table 6 – BELKNAP, Origin, Root-Mean-Square Surge Response, Single Amplitudes . . . . . 48

Table 7 – BELKNAP, Origin, Root-Mean-Square Sway Response, Single Amplitudes . . . . . 49

Table 8 – BELKNAP, Origin, Root-Mean-Square Heave Response, Single Amplitudes . . . . . 50

Table 9 – BELKNAP, Origin, Root-Mean-Square Roll Response, Single Amplitudes . . . . . 51

Table 10 – BELKNAP, Origin, Root-Mean-Square Pitch Response, Single Amplitudes . . . . . 52

Table 11 – BELKNAP, Origin, Root-Mean-Square Yaw Response, Single Amplitudes . . . . . 53

Table 12 – BELKNAP, Point 1, Root-Mean-Square Longitudinal Response, Single Amplitudes . . . . . 54

Table 13 – BELKNAP, Point 1, Root-Mean-Square Lateral Response, Single Amplitudes . . . . . 55

Table 14 – BELKNAP, Point 1, Root-Mean-Square Vertical Response, Single Amplitudes . . . . . 56

Table 15 - BELKNAP, Point 2, Root-Mean-Square Longitudinal Response, Single Amplitudes . . . . .	57
Table 16 - BELKNAP, Point 2, Root-Mean-Square Lateral Response, Single Amplitudes . . . . .	58
Table 17 - BELKNAP, Point 2, Root-Mean-Square Vertical Response, Single Amplitudes . . . . .	59
Table 18 - BELKNAP, Point 3, Root-Mean-Square Longitudinal Response, Single Amplitudes . . . . .	60
Table 19 - BELKNAP, Point 3, Root-Mean-Square Lateral Response, Single Amplitudes . . . . .	61
Table 20 - BELKNAP, Point 3, Root-Mean-Square Vertical Response, Single Amplitudes . . . . .	62
Table 21 - BELKNAP, Point 4, Root-Mean-Square Longitudinal Response, Single Amplitudes . . . . .	63
Table 22 - BELKNAP, Point 4, Root-Mean-Square Lateral Response, Single Amplitudes . . . . .	64
Table 23 - BELKNAP, Point 4, Root-Mean-Square Vertical Response, Single Amplitudes . . . . .	65
Table 24 - BELKNAP, Point 5, Root-Mean-Square Longitudinal Response, Single Amplitudes . . . . .	66
Table 25 - BELKNAP, Point 5, Root-Mean-Square Lateral Response, Single Amplitudes . . . . .	67
Table 26 - BELKNAP, Point 5, Root-Mean-Square Vertical Response, Single Amplitudes . . . . .	68
Table 27 - GARCIA, Origin, Root-Mean-Square Surge Response, Single Amplitudes . . . . .	69
Table 28 - GARCIA, Origin, Root-Mean-Square Sway Response, Single Amplitudes . . . . .	70
Table 29 - GARCIA, Origin, Root-Mean-Square Heave Response, Single Amplitudes . . . . .	71
Table 30 - GARCIA, Origin, Root-Mean-Square Roll Response, Single Amplitudes . . . . .	72
Table 31 - GARCIA, Origin, Root-Mean-Square Pitch Response, Single Amplitudes . . . . .	73
Table 32 - GARCIA, Origin, Root-Mean-Square Yaw Response, Single Amplitudes . . . . .	74
Table 33 - GARCIA, Point 1, Root-Mean-Square Longitudinal Response, Single Amplitudes . . . . .	75
Table 34 - GARCIA, Point 1, Root-Mean-Square Lateral Response, Single Amplitudes . . . . .	76

	Page
Table 35 – GARCIA, Point 1, Root-Mean-Square Vertical Response, Single Amplitudes . . . . .	77
Table 36 – GARCIA, Point 2, Root-Mean-Square Longitudinal Response Single Amplitudes . . . . .	78
Table 37 – GARCIA, Point 2, Root-Mean-Square Lateral Response, Single Amplitudes . . . . .	79
Table 38 – GARCIA, Point 2, Root-Mean-Square Vertical Response, Single Amplitudes . . . . .	80
Table 39 – GARCIA, Point 3, Root-Mean-Square Longitudinal Response, Single Amplitudes . . . . .	81
Table 40 – GARCIA, Point 3, Root-Mean-Square Lateral Response, Single Amplitudes . . . . .	82
Table 41 – GARCIA, Point 3, Root-Mean-Square Vertical Response, Single Amplitudes . . . . .	83
Table 42 – GARCIA, Point 4, Root-Mean-Square Longitudinal Response, Single Amplitudes . . . . .	84
Table 43 – GARCIA, Point 4, Root-Mean-Square Lateral Response, Single Amplitudes . . . . .	85
Table 44 – GARCIA, Point 4, Root-Mean-Square Vertical Response, Single Amplitudes . . . . .	86
Table 45 – GARCIA, Point 5, Root-Mean-Square Longitudinal Response, Single Amplitudes . . . . .	87
Table 46 – GARCIA, Point 5, Root-Mean-Square Lateral Response, Single Amplitudes . . . . .	88
Table 47 – GARCIA, Point 5, Root-Mean-Square Vertical Response, Single Amplitudes . . . . .	89

## NOTATION

$A_F$	Fin planform area per side of ship
$A_{jk}$	Added mass coefficient
$a_g$	Geometric aspect ratio of fin
$BL$	Molded baseline
$B_{jk}$	Damping coefficient
$b$	Highest (response) amplitude
$\overline{CG}$	Center of gravity
$CL$	Longitudinal centerline
$C_{jk}$	Hydrostatic restoring coefficient
$DWL$	Designed load waterline
$dC_L/d\beta$	Slope of lift-coefficient curve
$FP$	Forward perpendicular
$F_j$	Exciting force and moment
$\overline{GM}$	Transverse metacentric height
$g$	Acceleration due to gravity or 32.1725 ft/sec <sup>2</sup>
$\overline{KG}$	Height of center of gravity above baseline
$k_1, k_2, k_3$	Fin control-system gains
$LCG$	Longitudinal position of the center of gravity
$L_A$	Lateral displacement
$L_O$	Longitudinal displacement
$L_V$	Vertical displacement
$L_{PP}$	Length between perpendiculars of ship
$M_{jk}$	Generalized mass component of ship system
$N$	Number of cycles of response

$n$	Nondimensional roll-decay coefficient
$R(t)$	Ship response to a sinusoidal excitation
$R_A(\omega)$	Amplitude of ship response to a sinusoidal excitation—frequency-response function
$R_F$	Distance from roll axis to center of pressure of fin
$R_j$	Restoring force
$R_{L_A}(\omega), \dot{R}_{L_A}(\omega), \ddot{R}_{L_A}(\omega)$	Ship lateral displacement, velocity, and acceleration amplitudes—frequency-response functions
$R_{L_O}(\omega), \dot{R}_{L_O}(\omega), \ddot{R}_{L_O}(\omega)$	Ship longitudinal displacement, velocity, and acceleration amplitudes—frequency-response functions
$R_{L_V}(\omega), \dot{R}_{L_V}(\omega), \ddot{R}_{L_V}(\omega)$	Ship vertical displacement, velocity, and acceleration amplitudes—frequency-response functions
$S_R(\omega), \dot{S}_R(\omega), \ddot{S}_R(\omega)$	Ship displacement, velocity, and acceleration spectral densities
$S_R(\omega_E), \dot{S}_R(\omega_E), \ddot{S}_R(\omega_E)$	Ship displacement, velocity, and acceleration spectral densities in the encountered wave domain
$S_\zeta(\omega)$	Pierson-Moskowitz spectral density ordinates
$t$	Time variable
$V$	Ship speed
$x^*, y^*, z^*$	Coordinates of any point measured from the origin of the coordinate system of Figure 7
$x, x_A$	Surge and surge amplitude
$y, y_A$	Sway and sway amplitude
$z, z_A$	Heave and heave amplitude
$\beta$	Fin angle
$\Delta$	Ship displacement
$\epsilon$	Phase angle associated with response $R$
$\zeta_A$	Wave amplitude—single amplitude
$\zeta_w$	Height of wave from trough to crest—double amplitude



$(\tilde{\xi}_w)_{1/3}$	Significant wave height—average of one-third highest
$\xi_w/\lambda$	Wave steepness
$\theta, \theta_A$	Pitch and pitch amplitude
$\lambda$	Wavelength
$\mu$	Heading angle of ship with respect to wave direction
$\rho$	Mass density of water, 1.99 slugs/ft <sup>3</sup>
$\sigma^2$	Variance of ship response
$\sigma_R^2, \sigma_{\dot{R}}^2, \sigma_{\ddot{R}}^2$	Variances of ship displacement, velocity, and acceleration
$\sigma_{L_A}^2, \sigma_{\dot{L}_A}^2, \sigma_{\ddot{L}_A}^2$	Variances of ship lateral displacement, velocity, and acceleration
$\sigma_{L_O}^2, \sigma_{\dot{L}_O}^2, \sigma_{\ddot{L}_O}^2$	Variances of ship longitudinal displacement, velocity, and acceleration
$\sigma_{L_V}^2, \sigma_{\dot{L}_V}^2, \sigma_{\ddot{L}_V}^2$	Variances of ship vertical displacement, velocity, and acceleration
$\phi, \phi_A$	Roll and roll amplitude
$\phi_s/\phi_u$	Roll-reduction factor—ratio of stabilized to unstabilized roll
$\psi, \psi_A$	Yaw and yaw amplitude
$\omega$	Wave frequency
$\omega_E$	Wave encounter frequency
$\omega_\phi$	Natural or resonant frequency of roll



## ABSTRACT

Motion-response predictions of the helicopter landing platform for the USS BELKNAP (DLG-26) and USS GARCIA (DE-1040)-Class destroyers are presented. Predictions have been obtained by a computer-implemented procedure, which calculates response statistics at an arbitrary point on a ship in long-crested, irregular seas. The procedure is based on ship-motion theories in the state of the art. Results are presented for several ship speeds, states of sea, and ship headings—ranging from head to following waves. Existing envelopes of helicopter operations are discussed, and suggestions have been made, based upon the results of this study, for the listed new operational envelopes in higher states of seas:

1. Responses other than roll, e.g., vertical response at the landing platform, must be considered,
2. Quartering sea landings may be safer than bow sea landings,
3. To increase safety of operations, BELKNAP should be stabilized in roll.

## ADMINISTRATIVE INFORMATION

The work reported herein was authorized and funded by Naval Undersea Research and Development Center Work Request 2-0210 and by Naval Ship Systems Command Task S-F34 421 007, Work Unit 1-1568-302.

## INTRODUCTION

The purpose of this investigation is to predict responses of helicopter landing platforms on the USS BELKNAP (DLG-26) and the USS GARCIA (DE-1040)-Class destroyers in irregular long-crested seas. Computations are based upon ship motion theories in the state of the art, implemented on the CDC 6700 digital computer system. Results permit the study of platform-motion levels required for development of standard landing, tiedown, and takeoff techniques for the light airborne multipurpose system (LAMPS) helicopter.

Previous development of computer programs expedited the completion of this task. The computer program, developed by the Center<sup>1</sup> for ship motions and sea loads, provided response data for each ship in regular waves. The Center computer program for irregular sea-response predictions<sup>2</sup> was used to extend the

---

<sup>1</sup>Salvesen, N. et al., "Ship Motions and Sea Loads," Transactions of the Society of Naval Architects and Marine Engineers, Vol. 78, pp. 250–287 (1970). A complete listing of references is given on page 90.

<sup>2</sup>Meyers, W.G. and S.L. Bales, "Manual: NSRDC Irregular Sea Response-Prediction Computer Program," NSRDC Report 4011 (1973).

regular wave data to irregular sea-response statistics for points along the ship. This report presents a data base of landing platform-response predictions—displacement, velocity, and acceleration—for

1. Ship headings of 180, 150, 120, 90, 60, 30 and 0 deg with respect to waves
2. Ship speeds of 10, 20, and 30 knots
3. Significant wave heights of 4, 10, 16, and 20 ft.

### SHIP PARTICULARS

Table 1 presents the most important particulars of the two ships. Figures 1 and 2 give the body plans for each ship class. Figure 3 describes the bilge keels of each ship as well as the fin locations on

TABLE 1 – SHIP PARTICULARS

Ship Particulars	USS BELKNAP (DLG-26)	USS GARCIA (DE-1040)
Length Between Perpendiculars in Feet	524	390
Maximum Beam in Feet	54.4	43.7
Draft at Midship in Feet	18.8	14.5
Displacement in Long Tons	7800	3408
$\overline{KG}$ in Feet	19.75	16
$\overline{GM}$ in Feet	5.3	4.5
LCG from Forward Perpendicular in Feet	268.29	193.73
Roll Radius of Gyration as Percentage of Maximum Beam	35.15	35.13
Pitch Radius of Gyration as Percentage of $L_{pp}$	25.0	24.7
Yaw Radius of Gyration as Percentage of $L_{pp}$	25.0	24.7
Natural Heave Period in Seconds	6.7	5.88
Natural Roll Period in Seconds	9.93	8.90
Natural Pitch Period in Seconds	6.4	5.52

GARCIA, while Figure 4 describes the planform of the pair of active fins fitted to GARCIA.

Figures 5 and 6 give the location of the landing platform on each ship. Response predictions were made for the following five points on the landing platforms.

1. On the longitudinal centerline of the ship, at the forward edge of the platform
2. On the longitudinal centerline of the ship, at the center of the platform
3. On the longitudinal centerline of the ship, at the after edge of the platform
4. At a point displaced laterally from the center of the platform, halfway to the port edge
5. At a point above the center of the platform deck, coincidental with the center of gravity of a landed and secured LAMPS helicopter

The five points ( $x^*$ ,  $y^*$ ,  $z^*$ ) are measured from the origin of the coordinate system used in the calculation procedure. By definition, the origin is taken to be the intersection of the longitudinal centerline of the waterplane section with the transverse plane through the center of gravity. The coordinate system is arranged so that  $x^*$  is positive aft,  $y^*$  is positive to starboard, and  $z^*$  is positive upward. The coordinates of the points are given in Table 2, along with measurements corresponding to the distance of each point from the forward perpendicular (FP), longitudinal centerline (CL), and baseline (BL).

TABLE 2 – LOCATION OF HELICOPTER LANDING-PLATFORM POINTS FOR WHICH RESPONSES WERE PREDICTED

Ship	Point	$x^*$ ft	$y^*$ ft	$z^*$ ft	Distance From –		
					FP ft	CL ft	BL ft
USS BELKNAP (DLG-26)	1	108.71	0	19.70	377.00	0	38.50
	2	131.67	0	20.90	399.95	0	39.70
	3	154.63	0	20.95	422.90	0	39.75
	4	131.67	-10.38	20.90	399.95	-10.38	47.70
	5	131.67	0	28.90	399.95	0	47.70
USS GARCIA (DE-1040)	1	140.17	0	16.00	333.90	0	30.50
	2	158.47	0	16.49	352.20	0	31.00
	3	176.77	0	16.54	370.50	0	31.00
	4	158.47	-7.3	16.49	352.20	-7.3	31.00
	5	158.47	0	24.49	352.20	0	39.00

## PREDICTION OF SHIP RESPONSES IN REGULAR WAVES

### GENERAL DESCRIPTION

The initial step in the computational procedure is to obtain regular wave responses of the ship at the origin by execution of the Center computer program for ship motions and sea loads; see Reference 1.

When the program is applied, ship responses are computed to a sinusoidal excitation or regular wave of unit amplitude for a given frequency of wave encounter  $\omega_E$ , ship speed  $V$ , and heading angle to the wave

direction  $\mu$ , so that

$$R(t) = R_A \cos(\omega_E t - \epsilon) \quad (1)$$

where  $t$  is the time variable, and  $R_A$  and  $\epsilon$  are the response amplitude or frequency-response function and phase, respectively. The phase angle expresses the lag with respect to maximum wave elevation at the origin. The frequency of wave encounter is taken as

$$\omega_E = \left| \omega - \frac{\omega^2 V}{g} \cos \mu \right| \quad (2)$$

where  $\omega$  is wave frequency, and  $g$  is the acceleration due to gravity, i.e., 32.1725 ft/sec<sup>2</sup>.

Response amplitudes and phases are computed by the program for all six degrees of freedom, i.e., surge  $x$ , sway  $y$ , heave  $z$ , roll  $\phi$ , pitch  $\theta$ , and yaw  $\psi$ . Figure 7 shows the positive direction for these degrees of freedom while Figure 8 gives ship-heading angle with respect to wave direction  $\mu$ .

## ROLL RESPONSE

It is known that regular wave-roll responses can vary nonlinearly with wave steepness near the natural roll frequency. Figure 9a, from unpublished experimental work at the Center, shows that measured roll in beam waves is most nonlinear at zero speed and becomes fairly linear at Froude numbers 0.15, 0.30, and 0.46. However, roll predicted by using the theory given in Reference 1 is nonlinear at all speeds. The figure was based on data for the destroyer USS DEALEY (DE-1006) with a  $\overline{GM}$  comparable to values used in this investigation for BELKNAP and GARCIA.

It has been shown that the discrepancies between measured and predicted roll in Figure 9a are due to differences between the actual and the computed roll-damping coefficients. The figure shows that the best agreement for all steepnesses occurs at the lowest ship speed, Froude number 0.15. However, at the higher speeds, experiment and theory appear to agree best at higher wave steepnesses, for instance,  $\lambda/\xi_w$  ratios of 50 to 110. Figure 9b, also adapted from unpublished experiments done at the Center, compares measured and predicted roll at wave steepnesses of 1/50, 1/90, and 1/200 as functions of wave-to-ship-length ratio. The three solid-line curves represent the theoretical predictions of each steepness. The barred lines, e.g.,  $I$ , represent experimental values. The lower bar corresponds to the 1/50 case and the upper to the 1/200 case. The overall agreement between experiment and theory appears best at a wave steepness near 1/80.

Because the nonlinear roll predictions do not agree satisfactorily with the generally observed linear behavior of roll motion for nonzero speeds, roll is treated as a linear response by computing transfer functions for one selected value of wave steepness, i.e.,  $\frac{\xi_w}{\lambda} = 1/80$ . This value has been chosen after careful study of data typified by Figure 9, to best achieve agreement between the results of prediction and experiment for nonzero speeds.



It is interesting to note variations in the irregular sea-roll predictions when the wave steepness is varied for the regular wave prediction. Figure 10 shows such a comparison for BELKNAP for beam and bow seas. Roll predictions for two other wave steepnesses, 1/50 and 1/110, are compared with predictions for the 1/80 case. The data are shown as percentage differences in the root-mean-square roll with the 1/80 steepness data taken as the base. It is seen that the greatest difference, about 11 percent, is for the 1/50 steepness. The 1/110 case shows less than 8 percent of difference. In quartering seas, differences in the roll predictions can be expected to be about the same as with beam, bow seas. Thus, the variation in irregular sea-roll predictions, at speed, where roll is treated as a linear ship response is seen to be relatively small with changes in wave slope.

## SURGE, SWAY, AND YAW IN QUARTERING AND FOLLOWING WAVES

Reference 1 and data obtained from model experiments at the Center indicate that there is reasonable agreement between theory and experiment in head, bow, beam, quartering, and following seas for regular wave predictions of heave, pitch, and roll. Further, sway and yaw appear to be reasonably well predicted in all but quartering waves and surge in all but quartering and following waves; sway and yaw are zero in following waves.

The theory fails for these particular conditions because of overpredicted responses at zero wave-encounter frequency at higher ship speeds. The equations of motion for surge, heave, and pitch are coupled as also are the equations for sway, roll, and yaw. The equations for surge, sway, and yaw do not possess hydrostatic restoring coefficients  $C_{jk}$ , and an illustration of breakdown in the theory for zero wave-encounter frequency is given in the following text for a simplified equation of motion for any response  $R_j$ , i.e., one-degree-of-freedom equation.

Consider

$$(M_{jk} + A_{jk}) R_j'' + B_{jk} R_j' + C_{jk} R_j = F_j e^{i\omega_E t} \quad (3)$$

where  $M_{jk}$  is a generalized mass component  
 $A_{jk}, B_{jk}$  are the added mass and damping coefficients  
 $F_j$  is the wave-excitation amplitude.

Equation (3) possesses a solution

$$R_j = |R_j| e^{i\omega_E t} \quad (4)$$

where

$$|R_j| = \frac{F_j}{\left\{ (C_{jk})^2 - 2 [C_{jk} - (B_{jk})^2] \omega_E^2 + (M_{jk})^2 \omega_E^4 \right\}^{1/2}} \quad (5)$$

which becomes

$$|R_j| = \frac{F_j}{\left[ 2 (B_{jk})^2 \omega_E^2 + M_{jk}^2 \omega_E^4 \right]^{1/2}} \quad (6)$$

when the hydrostatic restoring coefficient is zero. The damping coefficient  $B_{jk}$  tends to zero with wave encounter frequency  $\omega_E$  in quartering and following waves, and  $|R_j|$  becomes very large, which is not consistent with experimental measurements for surge, sway, and yaw amplitude responses.

For BELKNAP and GARCIA, the theory indicates that the problem of zero encounter frequency arises at 20 and 30 knots for surge, sway, and yaw at  $\mu = 30$  and 60 deg and for surge at  $\mu = 0$  deg. Thus, no data have been presented for these conditions.

## PREDICTION OF SHIP-RESPONSE STATISTICS IN IRREGULAR SEAS

### GENERAL DESCRIPTION

The ship responses to long-crested, irregular waves are found by summing the ship responses to regular waves for all frequencies. This application of the principle of superposition to ship motion predictions was first proposed by St. Denis and Pierson<sup>3</sup> and is now a widely accepted and proven procedure.

The ship motion spectral density is given by

$$S_R(\omega) = [R_A(\omega)]^2 \cdot S_\zeta(\omega) \quad (7)$$

where  $S_\zeta(\omega)$  is the irregular sea spectral density, and  $[R_A(\omega)]^2$  is the response amplitude operator, making use of

---

<sup>3</sup>St. Denis, M. and W.J. Pierson, "On the Motion of Ships in Confused Seas," Transactions of The Society of Naval Architects and Marine Engineers, Vol. 61, pp. 280-237 (1953).

$$S_R(\omega_E) d\omega_E = S_R(\omega) d\omega \quad (8)$$

The integration of  $S_R(\omega)$  over the frequency range, i.e.,

$$\sigma_R^2 = \int_0^{\infty} S_R(\omega) d\omega \quad (9)$$

can be shown to be the same as the variance of consecutive, equally spaced samples from an irregular sea time history of the motion response. Such time-history samples tend to follow a normal or Gaussian distribution, while peak-to-peak variations or amplitudes will tend to be approximated by a Rayleigh distribution. By integration of the Rayleigh probability density function (Appendix A) the probability of occurrence of a given response amplitude may be found. Table 3 gives a summary of the constants which relate the root-mean-square value of the response  $\sigma_R$  to particular amplitudes. For example, the highest expected amplitude in 10 cycles of response is 2.15  $\sigma_R$ , etc. By the definition given in Table 3 and in Appendix A, any statistic not listed may be determined.

TABLE 3 – SINGLE AMPLITUDE STATISTICAL CONSTANTS FOR A FULLY DEVELOPED WIND-GENERATED SEA

Single Amplitude Statistics	
	$\sigma$
Root-Mean-Square Amplitude	1.00
Average Amplitude	1.25
Average of Highest One-Third Amplitudes	2.00
Highest Expected Response Amplitude in 10 Cycles	2.15
Average of Highest One-Tenth Amplitudes	2.55
Highest Expected Amplitude in Indicated Cycles of Response —	
30	2.61
50	2.80
100	3.03
200	3.25
1000	3.72

Note:  $\sigma^2$  is statistical variance of time history;  $N$  is number of cycles; CONSTANT is  $\sqrt{2} (\ln N)^{1/2}$ , where CONSTANT relates  $\sigma$  to the highest expected amplitude in  $N$  cycles.

In a manner similar to that previously described, the spectral density of ship-response velocity  $S_R^{\dot{}}$ , and its variance  $\sigma_R^{\dot{2}}$ , respectively, are found by

$$S_R^{\dot{}}(\omega) = [\omega_E(\omega) \cdot R_A(\omega)]^2 \cdot S_{\xi}(\omega) \quad (10)$$

and

$$\sigma_R^{\dot{2}} = \int_0^{\infty} S_R^{\dot{}}(\omega) d\omega \quad (11)$$

Likewise, the spectral density of ship-response acceleration  $S_R^{\ddot{}}$  and variance  $\sigma_R^{\ddot{2}}$ , respectively, are given by

$$S_R^{\ddot{}}(\omega) = \{[\omega_E(\omega)]^2 \cdot R_A(\omega)\}^2 \cdot S_{\xi}(\omega) \quad (12)$$

and

$$\sigma_R^{\ddot{2}} = \int_0^{\infty} S_R^{\ddot{}}(\omega) d\omega \quad (13)$$

The same single amplitude statistics (Table 3) which apply to the variances of linear and angular displacement motion also apply to the variances of velocity and acceleration. In general, for the acceleration responses in surge, sway, and heave,  $\sigma_R^{\ddot{}}$  is divided by 32.1725 ft/sec<sup>2</sup> to provide the value in g's.

It should be noted that because GARCIA is fitted with fins, a special step is required in the calculation procedure. The unstabilized roll responses in regular waves are reduced by the factors derived in Appendix B to obtain the stabilized-roll responses. These stabilized-roll responses are then used in Equation (7) to determine the spectral density of stabilized-roll response.

Equations (7) through (13) refer to responses predicted at the origin of the coordinate system. They may be used to predict responses at any other point on the ship.

## FREQUENCY-RESPONSE FUNCTIONS AT AN ARBITRARY POINT

The longitudinal, lateral, and vertical displacements  $L_O$ ,  $L_A$ , and  $L_V$ , respectively, at a point ( $x^*$ ,  $y^*$ ,  $z^*$ ) are expressed as

$$\begin{aligned}
L_O &= x - y^* \sin \psi + z^* \sin \theta + x^* (\cos \psi + \cos \theta) - 2x^* \\
L_A &= y - z^* \sin \phi + x^* \sin \psi + y^* (\cos \phi + \cos \psi) - 2y^* \\
L_V &= z - x^* \sin \theta + y^* \sin \phi + z^* (\cos \theta + \cos \phi) - 2z^*
\end{aligned} \tag{14}$$

where the displacements are functions of frequency and time. If small angles are assumed, Equations (14) reduce to

$$\begin{aligned}
L_O &= x - y^* \psi + z^* \theta \\
L_A &= y - z^* \phi + x^* \psi \\
L_V &= z - x^* \theta + y^* \phi
\end{aligned} \tag{15}$$

In this form it is straightforward to derive the frequency-response functions  $R_{L_O}(\omega)$ ,  $R_{L_A}(\omega)$ , and  $R_{L_V}(\omega)$  by calculating real and imaginary parts of  $L_O$ ,  $L_A$ , and  $L_V$  for a given frequency and by using the approach already described to obtain required variance values  $\sigma_{L_O}^2$ ,  $\sigma_{L_A}^2$ , and  $\sigma_{L_V}^2$ .

Frequency-response functions of velocity and acceleration are obtained from the frequency-response functions of displacement by taking the product with  $\omega_E(\omega)$  and  $[\omega_E(\omega)]^2$ , respectively; hence  $\sigma_{L_O}^{\cdot 2}$ ,  $\sigma_{L_O}^{\ddot{\cdot} 2}$ , etc. As before, acceleration responses,  $\sigma_{L_O}^{\ddot{\cdot} 2}$ , etc., are divided by  $32.1725 \text{ ft/sec}^2$  to provide the value in g's.

## IRREGULAR SEA REPRESENTATION

The long-crested seaway is analytically represented by the spectral density ordinates of Pierson and Moskowitz

$$S_{\xi}(\omega) = \frac{a g^2}{\omega^5} \exp \left[ - \frac{4 a g^2}{(\tilde{\xi}_w)_{1/3}^2 \omega^4} \right] \text{ft}^2 \times \text{sec} \tag{16}$$

where  $\omega$  is the wave frequency in radians per second,  $a = 0.0081$ ,  $g = 32.1725 \text{ ft/sec}^2$ , and  $(\tilde{\xi}_w)_{1/3}$  is the significant wave height in feet.

Equation (16) represents the energy of a fully developed, wind-generated sea, and values used for this investigation for  $(\tilde{\xi}_w)_{1/3} = 4, 10, 16, \text{ and } 20 \text{ ft}$  are given in Figure 11. Table 4 shows the corresponding wind velocities and Center scale for states of sea.

TABLE 4 – DEFINITION OF STATE OF SEA

Significant Wave Height ft	Wind Velocity knots	Center State of Sea Scale
4	14.70	3
10	23.25	5
16	29.41	6
20	32.88	6

## SPECTRAL CLOSURE

Accuracy of the calculation of response variance  $\sigma_R^2$ , described previously, relies heavily on proper calculation of the areas under each response spectrum. If the values of  $S_R(\omega)$  approach zero at high and low frequencies, spectral closure is attained. For this case the area is well defined and, thus, will be accurately calculated. It has been found that the area is still well defined if the response values of spectral density at the lower and higher ends of the curve are less than 10 percent of the spectral value of maximum response.

Further, the response spectrum closes properly if the product of the response-amplitude operator and the spectral ordinate of the wave closes. This means that it is not necessary for the response-amplitude operator to close as long as the wave spectrum closes and vice versa. Figure 12 illustrates a case when the curve of the response-amplitude operator is open at the low-frequency end; yet, the response spectrum is closed.

For this investigation, the response spectrum was forced to closure at the high-frequency end. Regular wave responses were computed for ratios of wave-to-ship length  $\lambda/L_{PP}$  from 4.2 to 0.1. To ensure proper closure, response-amplitude operators were set to zero for a wave-to-ship-length ratio of 0.05. This value is a conservative choice on the basis of previous experimental and theoretical investigations.



## RESULTS

### DATA BASE OF PLATFORM RESPONSES FOR USS BELKNAP (DLG-26) AND USS GARCIA (DE-1040)

Table 5 summarizes the information given in Tables 6 to 47 in Appendix C, which give the results of the investigation. Each table presents the predictions of root-mean-square value for displacements, velocities, and accelerations for a given response for heading angles  $\mu = 180$  (head), 150, 120, 90, 60, 30, and 0 (following) deg; ship speeds  $V = 10, 20,$  and 30 knots; and significant wave heights  $(\tilde{\xi}_w)_{1/3} = 4, 10,$  16, and 20 ft.

TABLE 5 – DESCRIPTION OF DATA-BASE PRESENTATION

Table Numbers*	Response/Direction	Location
6, 27 7, 28 8, 29 9, 30 10, 31 11, 32	Surge Sway Heave Roll Pitch Yaw	Origin
12, 33 13, 34 14, 35	Longitudinal Lateral Vertical	Point 1
15, 36 16, 37 17, 38	Longitudinal Lateral Vertical	Point 2
18, 39 19, 40 20, 41	Longitudinal Lateral Vertical	Point 3
21, 42 22, 43 23, 44	Longitudinal Lateral Vertical	Point 4
24, 45 25, 46 26, 47	Longitudinal Lateral Vertical	Point 5
* Tables 6 through 26 refer to BELKNAP; Tables 27 through 47 refer to GARCIA.		

The dimensions of the root-mean-square values are as given within Tables 6 to 47. Hyphenated spaces indicate a condition for which theory fails to predict reliable values, e.g., surge, sway, yaw-quartering, following seas.

As described previously, other single amplitude statistics or probabilities of occurrence may be determined from the root-mean-square values. Values for the highest response in 100 cycles of response, shown in Figures 13 through 21, are derived directly from Tables 6 through 47 by using Table 3.

## LANDING PLATFORM AND SHIP-RESPONSE LEVELS

Suppose the highest of 100 amplitudes of response is required to investigate, for example, impact-force tolerances of LAMPS landing gear. The highest of 100 values is obtained from given root-mean-square values by using Table 3, i.e.,  $3.03 \sigma_R$ . There are many ways to cross plot these data in studying the response levels and trends of the two ships.

As an example, it is of interest to compare the motions predicted at the *LCG*, waterplane, *CL* intersection of the ship with those at the  $\overline{CG}$  of the landed helicopter, i.e., Point 5, for a State 5 sea. Figures 13 through 15 show displacements in the longitudinal, lateral, and vertical directions for these points at 10, 20, and 30 knots and significant wave height of 10 feet.

Another interesting comparison is that between selected motions for each ship for all headings and speeds. Figures 16 and 17 show the highest roll and pitch angles, respectively, expected in 100 cycles for both ships. It can be seen that roll is worse for BELKNAP, while pitch is worse for GARCIA. Figures 18 through 20 compare longitudinal, lateral, and vertical velocities at  $\overline{CG}$ , i.e., Point 5, of a helicopter that has landed on each ship.

Another useful cross plot is the comparison between the motions of the two ships in different states of sea for a given speed. Figure 21 shows the vertical velocity at  $\overline{CG}$  of the landed helicopter for each ship in all four states of sea at 20 knots. It is apparent that the vertical velocity of GARCIA is higher for  $\mu > 90$  deg than is that for BELKNAP in each state of sea.

## EVALUATION OF DATA

Experiments conducted by the Naval Air Test Center (Patuxent, Md.) have shown the compatibility of LAMPS helicopter operations with BELKNAP and smaller GARCIA-Class destroyers. References 4

---

<sup>4</sup>Kizer, G.R. and G.D. Carico, "Final Report Navy Evaluation of the Helicopter Hauldown System," Naval Air Test Center Technical Report FT-20R-69 (Mar 1969).

through 7 discuss the experiments conducted on these or similar ships with LAMPS or similar helicopters. Having established compatibility between ship and helicopter, it is most desirable to establish consistent landing, tiedown, and takeoff techniques. The same references present ship-motion envelopes for helicopter operations from data already collected. The data base presented in this report can be used to reevaluate the envelopes of existing ship motions for which, in general, only roll motion is considered and to develop new operational envelopes for other ship motions and states of sea.

For example, in low states of sea, such as a State 3 sea, the referenced experimental results indicate that heave and pitch motions are not of significant importance to landing-platform operations. Indeed, Tables 8, 10, 29, and 31 show very small pitch and heave magnitudes for a significant wave height of 4 ft. Likewise, roll responses are of small magnitudes. To land in such conditions, the helicopter will usually hover above the deck until a near level attitude  $\pm 3$  deg of roll is approached. Usually, the roll frequency is small enough for the helicopter to land in the time that the deck is nearly level. This landing technique reduces the possibility of landing out of the landing circle as well as of applying asymmetrical loads on the landing gear. It is important for the helicopter to set down within the landing circle and land nearly level because it might otherwise damage either itself or the adjacent superstructure of the ship; perhaps even worse, it might slip off the side of the ship. Further, it is important that only symmetrical loads be induced on the landing gear to avoid damage to the landing gear.

The existing ship-motion envelopes for helicopter operations consider roll angle only, although Reference 7 does give valid motion envelopes to 5 deg of pitch angle. Tables 9 and 30 show smaller roll angles in bow seas than in beam and quartering seas for the low state of sea. This substantiates the fact that References 4 through 7 generally state that landings require less pilot effort and are thus more safe in bow seas.

Though such an investigation is not reported, References 4 through 7 imply that any significant increase in heave and pitch with increase in state of sea may effect helicopter operations. For a given heading, Tables 8, 10, 29, and 31 do show a relatively large increase in heave response, while pitch response increases somewhat less dramatically when state of sea is increased. Also, roll response, as presented in Tables 9 and 30, increases rather significantly at the higher states of sea. One way to investigate the relative importance of each of the three responses—heave, roll, and pitch—in any state of sea is through vertical response predicted for points on the landing platform of each ship. It is shown in Equation (15) that the vertical response is dependent on each of these three responses. As can be expected, Tables 17 and 38 show small values for the vertical response at the centers of the landing platforms at the low state

---

<sup>5</sup>Parkinson, R. et al., "Final Report Evaluation of the DE-1052 Class Destroyer for HH-2D Helicopter Operations," Naval Air Test Center Technical Report FT-4R-71 (Feb 1971).

<sup>6</sup>Parkinson, R. and G. Hurley, "Fifth Interim Report, LAMPS Support and Monitor (Evaluation of the DE-1040-Class Destroyer for HH-2D Helicopter Operations)," Naval Air Test Center Technical Report FT-41R-71 (May 1971).

<sup>7</sup>Lineback, H.W. and A.B. Hill, "First Interim Report Helicopter/VSTOL Compatibility Program (DLG-26/SH-2D Dynamic Interface Flight Envelope)," Naval Air Test Center Report of Test Results FT-91R-71 (Dec 1971).

of sea. However at the higher states of sea the vertical responses are of much greater magnitude. Such vertical responses may be used to study loads on the helicopter landing gear and on the helicopter hauldown systems.

Knowledge of ship heading for minimum response levels is important to helicopter operations. Generally, the responses are smallest in bow seas at lower states of sea; hence, it is considered safest to land in bow seas for low states of sea. But as states of sea and, thus, responses increase, the tables may show smaller responses in quartering than in bow seas. For example, the vertical displacement at the platform center of BELKNAP is slightly less at 30 deg and 10 knots than at 150 deg and 10 knots for States 5, 6, and high 6 seas; see Table 17. Perhaps of more significance, the corresponding vertical velocities are much less in all quartering sea headings than in bow seas. Thus, when considering vertical and roll responses, it appears that landings to be made in high states of sea are safest when the ship is in quartering seas.

In general, origin responses for BELKNAP are of less magnitude than those for GARCIA, except for the case of roll response in which GARCIA is stabilized, and BELKNAP is not. Further, when considering higher state of sea responses, predicted at corresponding points on each ship landing platform, it is found that longitudinal and vertical responses of the BELKNAP class are less than those of the GARCIA class, while the lateral responses of the stabilized GARCIA are less than those for BELKNAP. Thus, if safer helicopter operations are required of the BELKNAP-Class, especially in higher states of sea, the response data imply that the ship should be stabilized in roll.

## CONCLUDING REMARKS

The computational procedure described in this report has been applied to obtain response predictions for the helicopter landing platforms of two destroyer classes. From consideration of these predictions, the following conclusions may be drawn.

1. Predicted response trends are consistent with observed helicopter operations in low states of sea.
2. Responses other than roll, e.g., vertical response of the landing platform, must be considered to develop ship motion envelopes for helicopter operations in high states of sea. Predicted responses may be used to determine these envelopes for helicopter landing, tiedown, and takeoff operations on the two destroyer classes within a range from States 3 to 6 seas and from 10 to 30 knots.
3. Helicopter operations in high states of sea may be safer in quartering than in bow seas as certain response magnitudes, e.g., vertical velocity of the landing platform, are less in quartering seas.
4. To expedite increased safety for helicopter operations in higher states of sea, the BELKNAP (DLG-26) class should be stabilized in roll.

The seaway applied in this calculation procedure is that of a fully developed, unidirectional, wind-generated sea. Consideration is presently being given to develop more realistic representations of the seaway. Such representations can include components of swell and have the form of a short-crested seaway with two parameters.

The computational method which has been developed and used in this investigation may be applied to many other problems besides the one described herein, e.g., requiring the spectral responses or the spectral loads at any point on a ship operating in a seaway. For example, the method may be used to predict the vertical displacement, velocity, and acceleration experienced on the bridge in beam seas in a State 7 sea. Further, it is believed that the described method will be of use to both the naval architect who must design ships for optimum seaworthiness and the engineer who must modify and study existing ships in an effort to extend the operational efficiency and capability of the fleet.

It should be emphasized that the choice of a specific wave steepness, i.e.,  $\frac{\xi_w}{\lambda} = 1/80$ , to compute roll-transfer functions is solely to obtain best agreement between theoretical prediction and experimental data. It is not meant to typify actual sea-wave steepness.

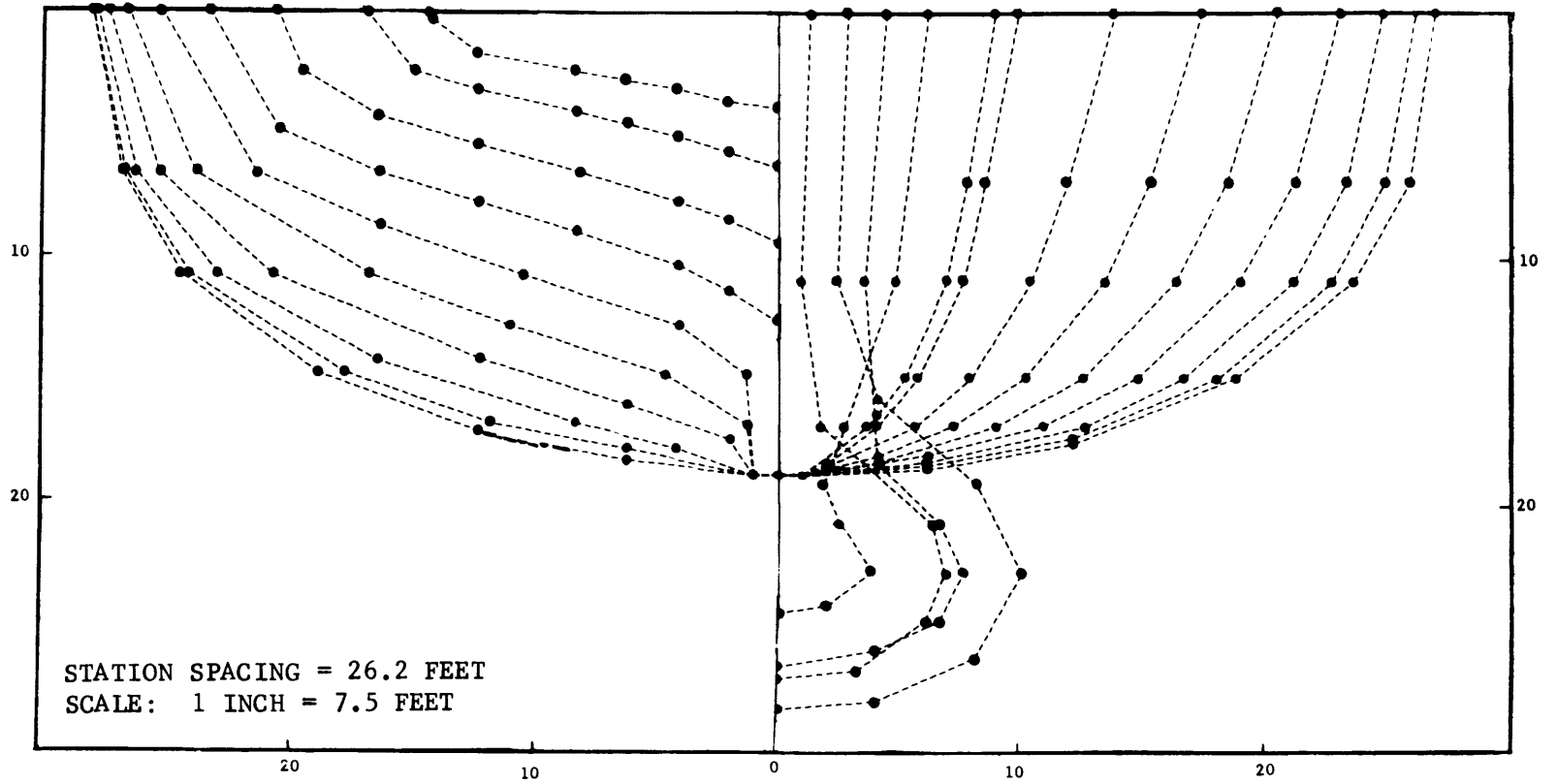

Figure 1 – Computer Fit of USS BELKNAP (DLG-26) Body Plan



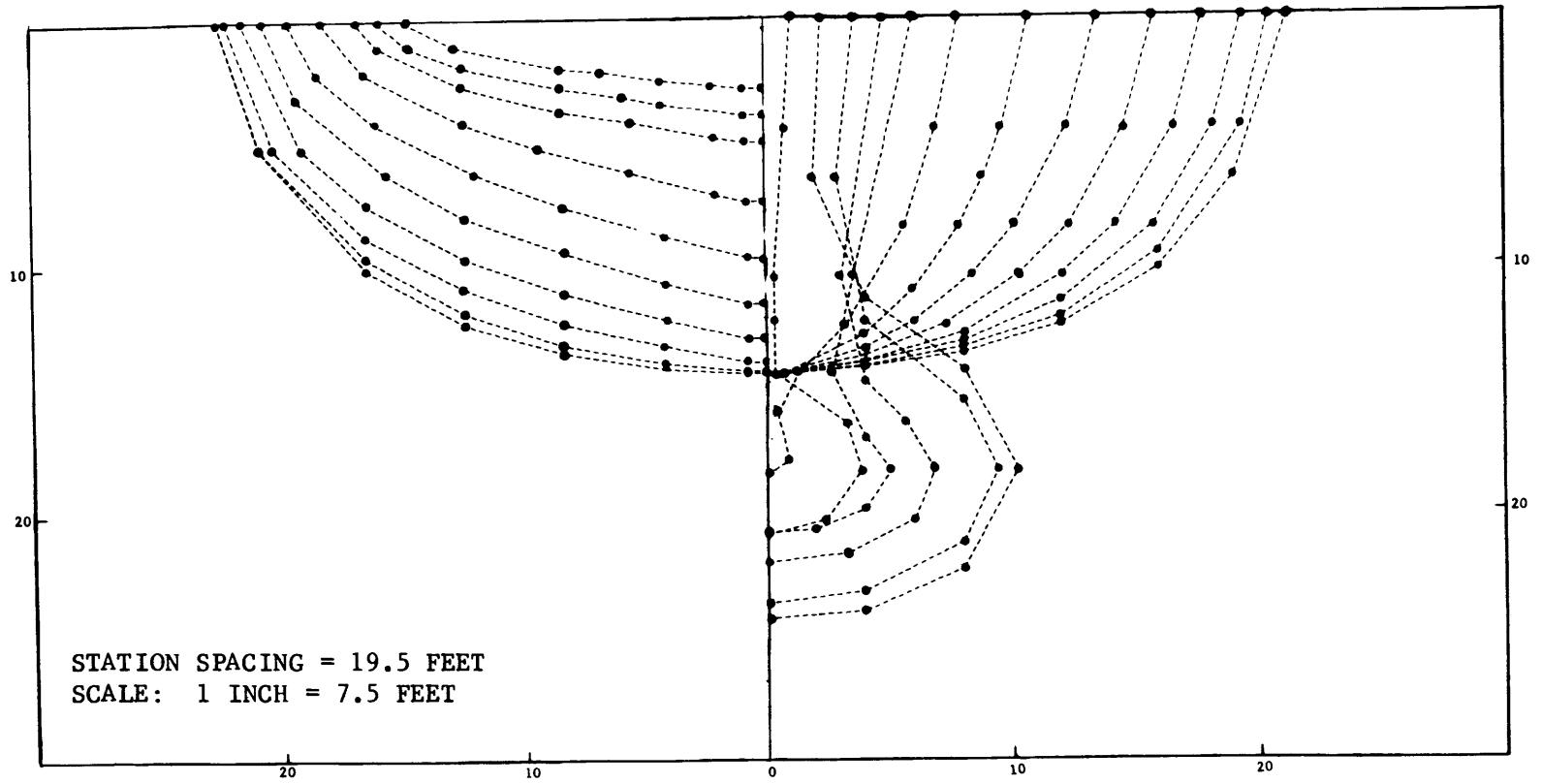

Figure 2 – Computer Fit of USS GARCIA (DE-1040) Body Plan

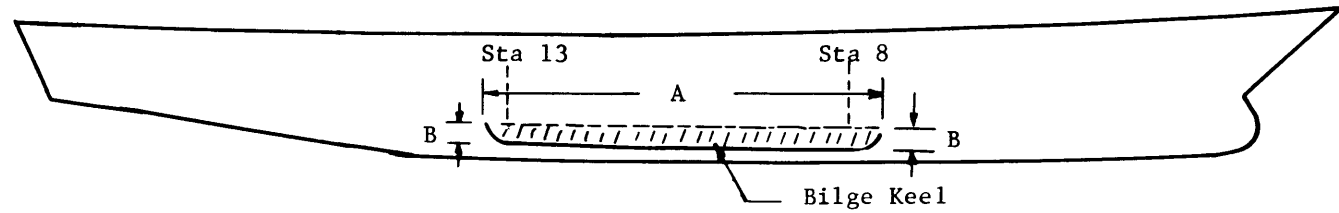
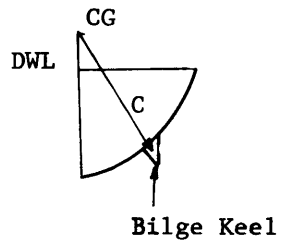

Figure 3a - USS BELKNAP (DLG-26)

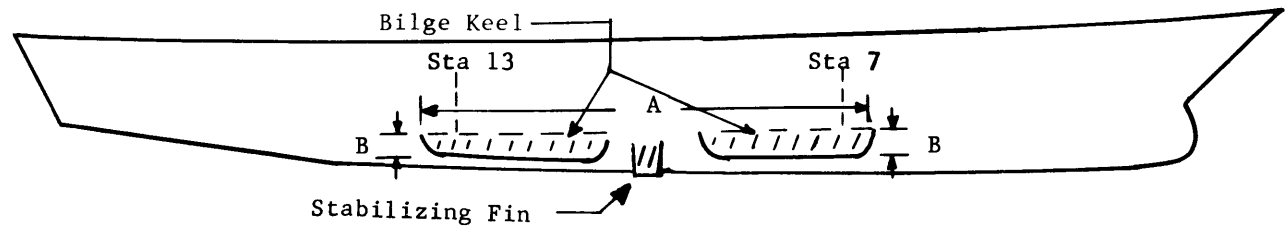
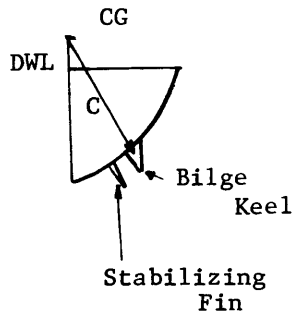
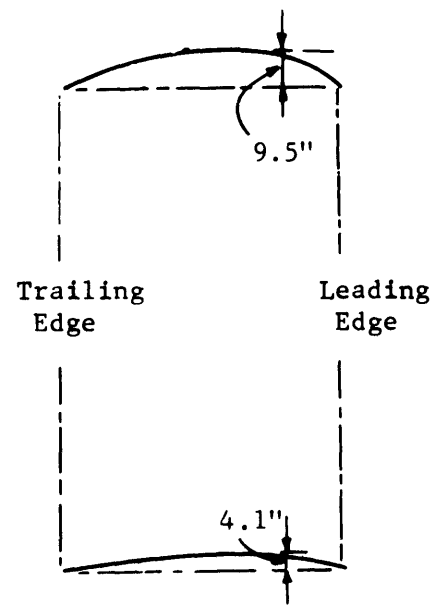
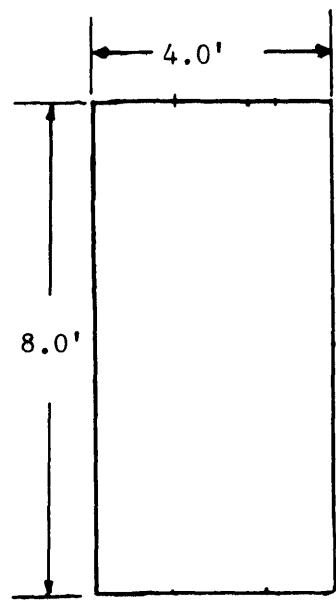
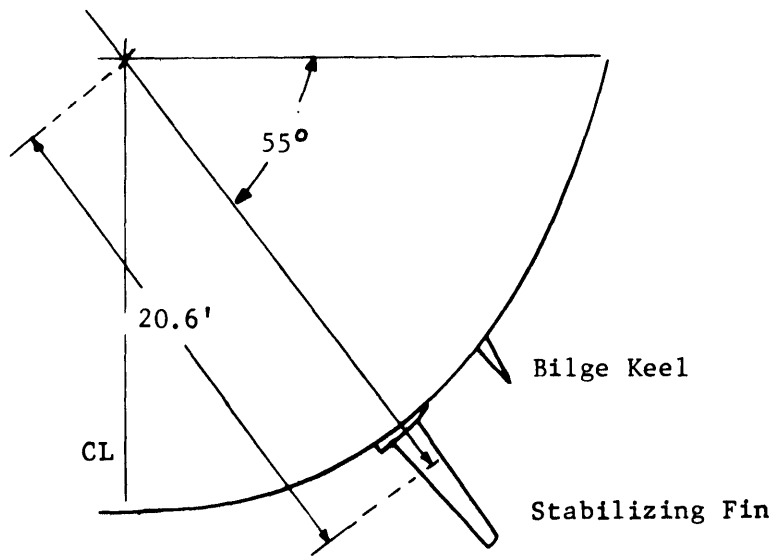

Figure 3b - USS GARCIA (DE-1040)

	DLG-26	DE-1040
A Keel Length (Feet)	153.8	114.5
B Maximum Width (Feet)	2.5	1.5
C Distance From CG (Feet)	26.6	20.6

Figure 3 - Location and Size of Bilge Keels on BELKNAP and GARCIA and Location of Fin on GARCIA



Planform Area, $A_F$	32 Square feet
Span	8 Feet
Aspect Ratio, $a_g$	2

Figure 4 – Stabilizing Fin for GARCIA

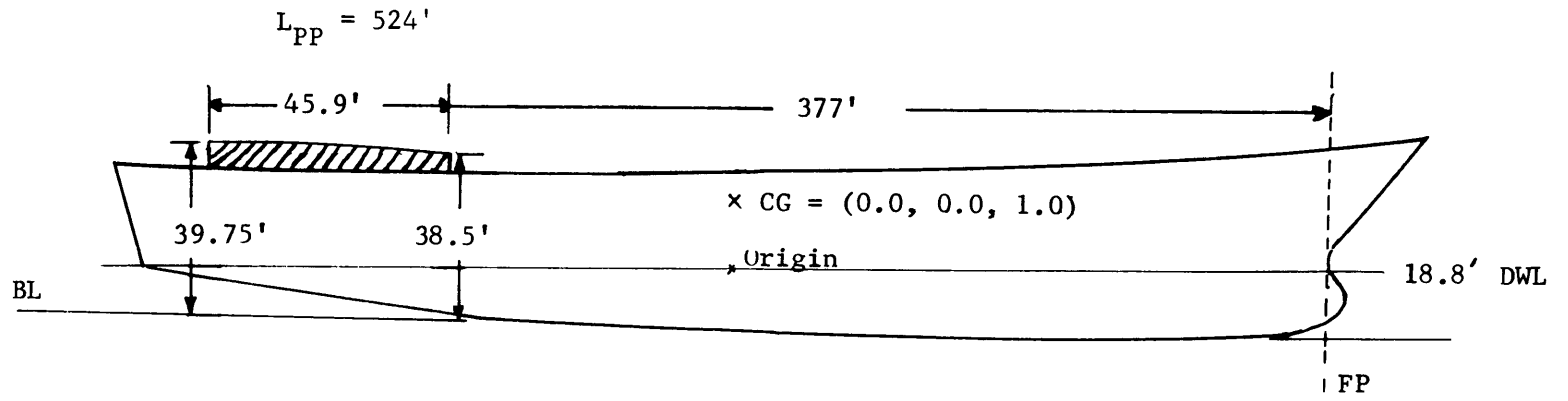

20

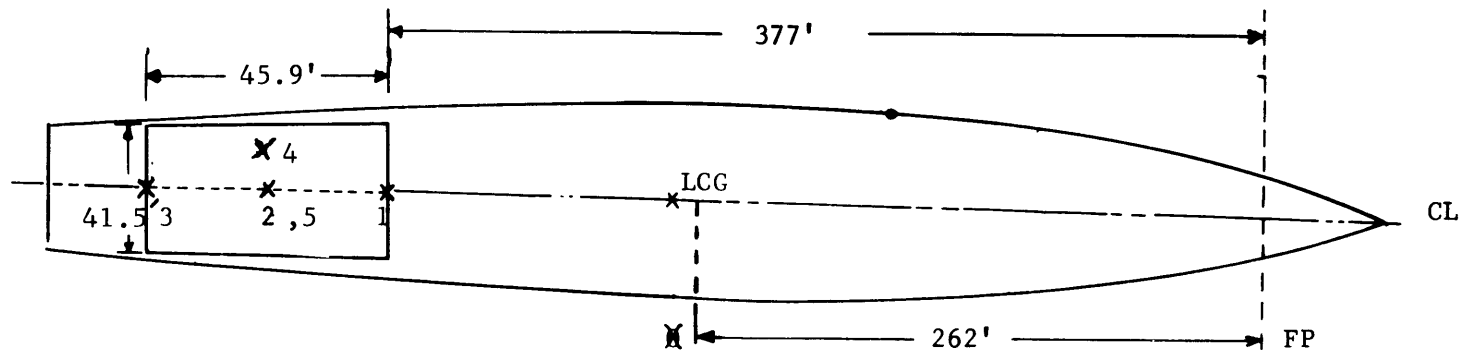

(NOT TO SCALE)

Figure 5 – Location and Size of Helicopter Landing Platform on BELKNAP and Location of Points for which Responses Were Predicted

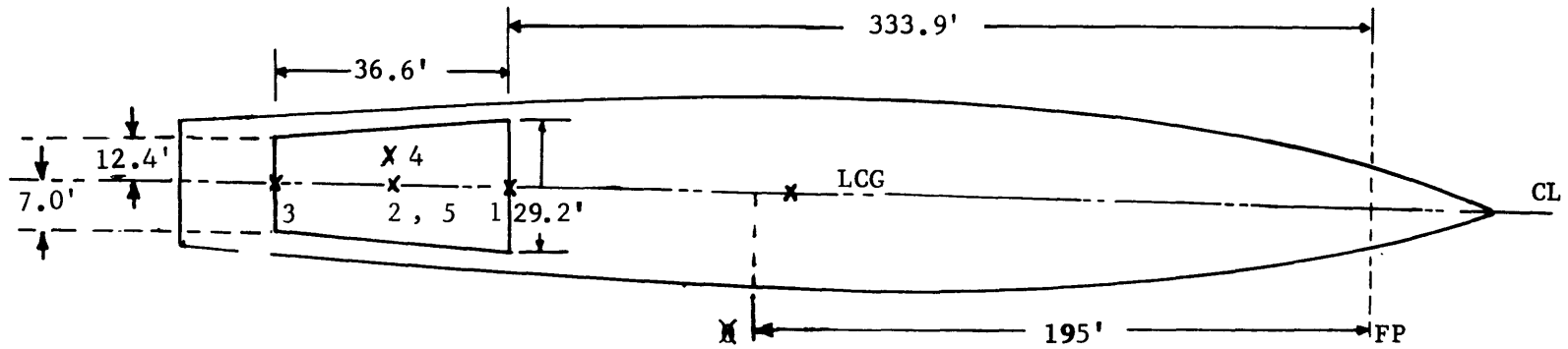
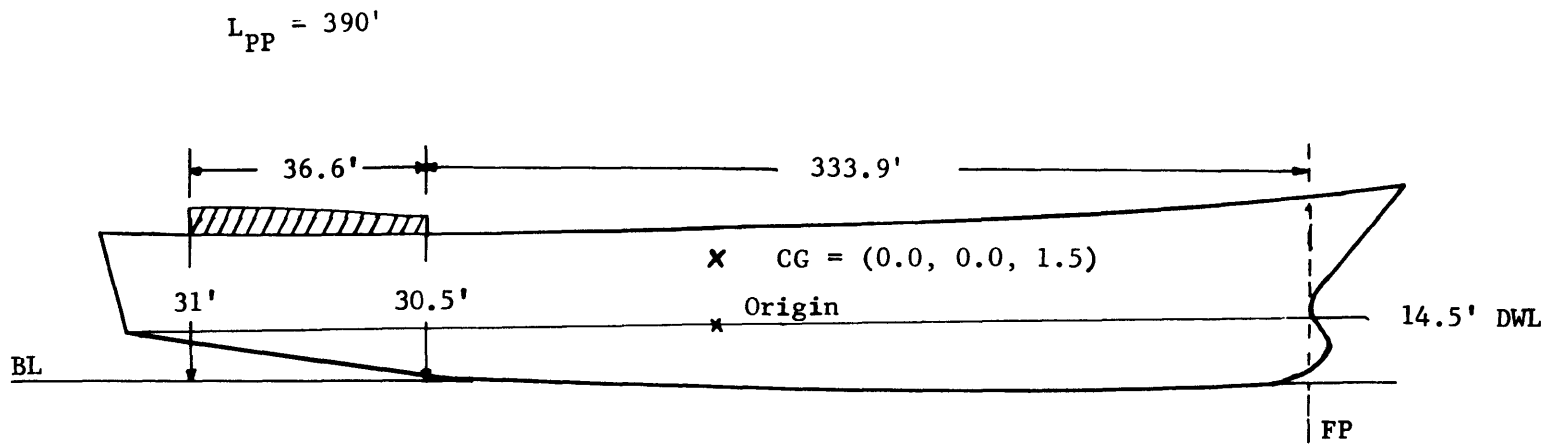

(NOT TO SCALE)

Figure 6 – Location and Size of Helicopter Landing Platform on GARCIA and Location of Points for which Responses Were Predicted

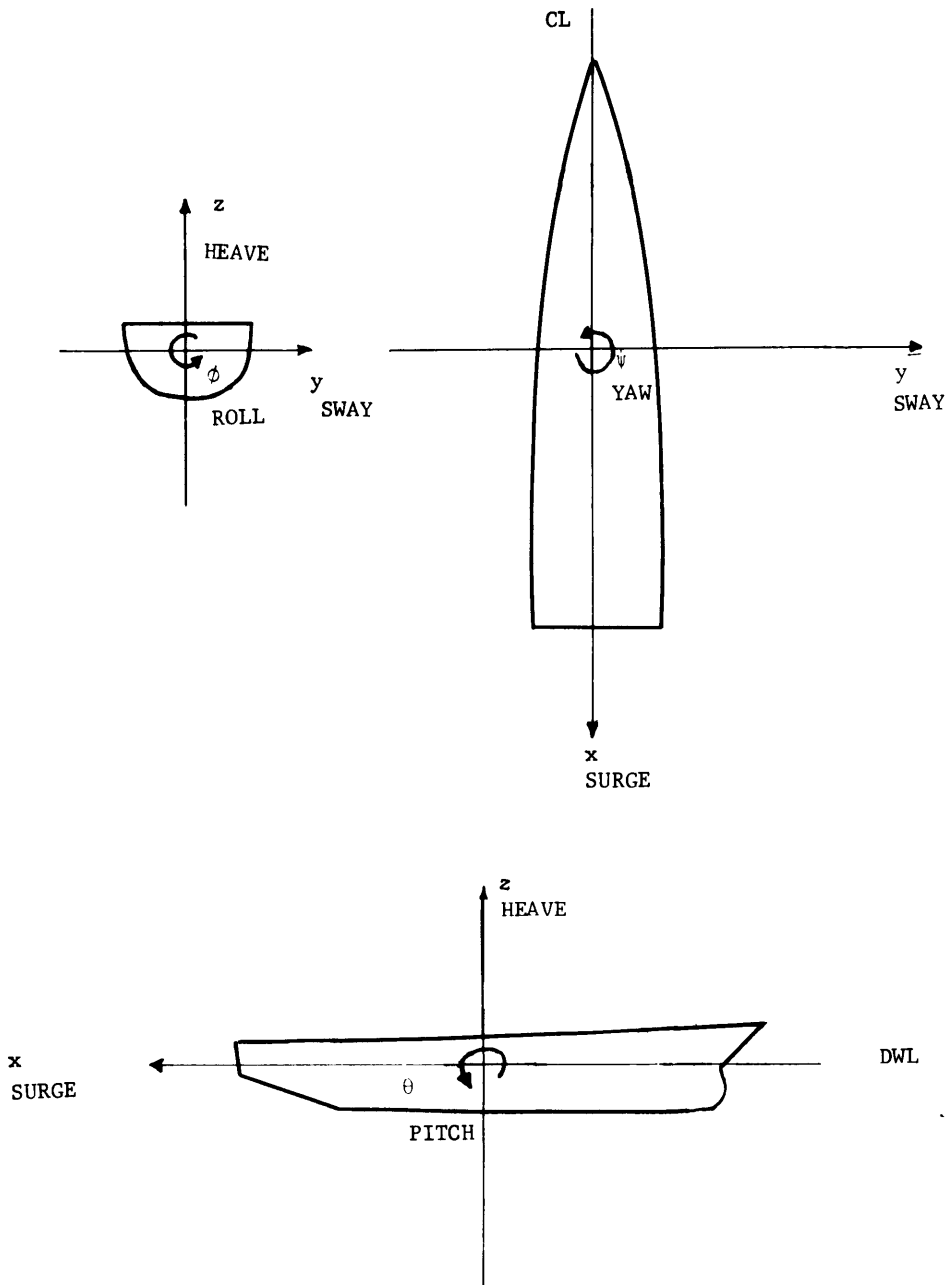

Figure 7 – Right-Handed Coordinate System for Response Predictions

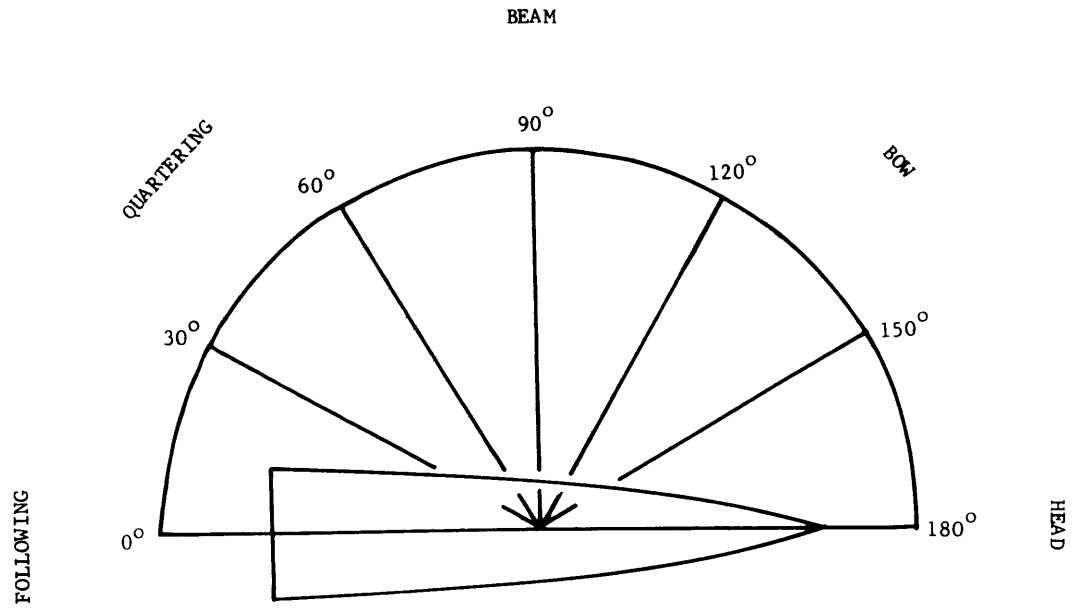

Figure 8 – Incident-Wave Directions with Respect to Ship

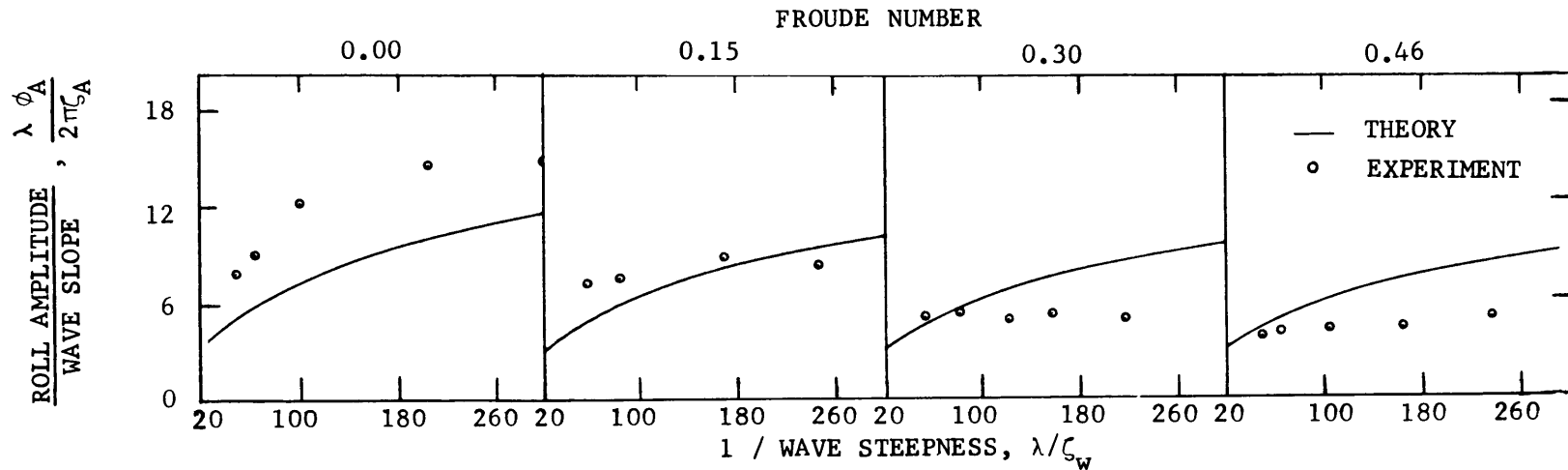

Figure 9a – Nondimensional Roll-Transfer Function versus 1/Wave Steepness at the Natural Roll Frequency

24

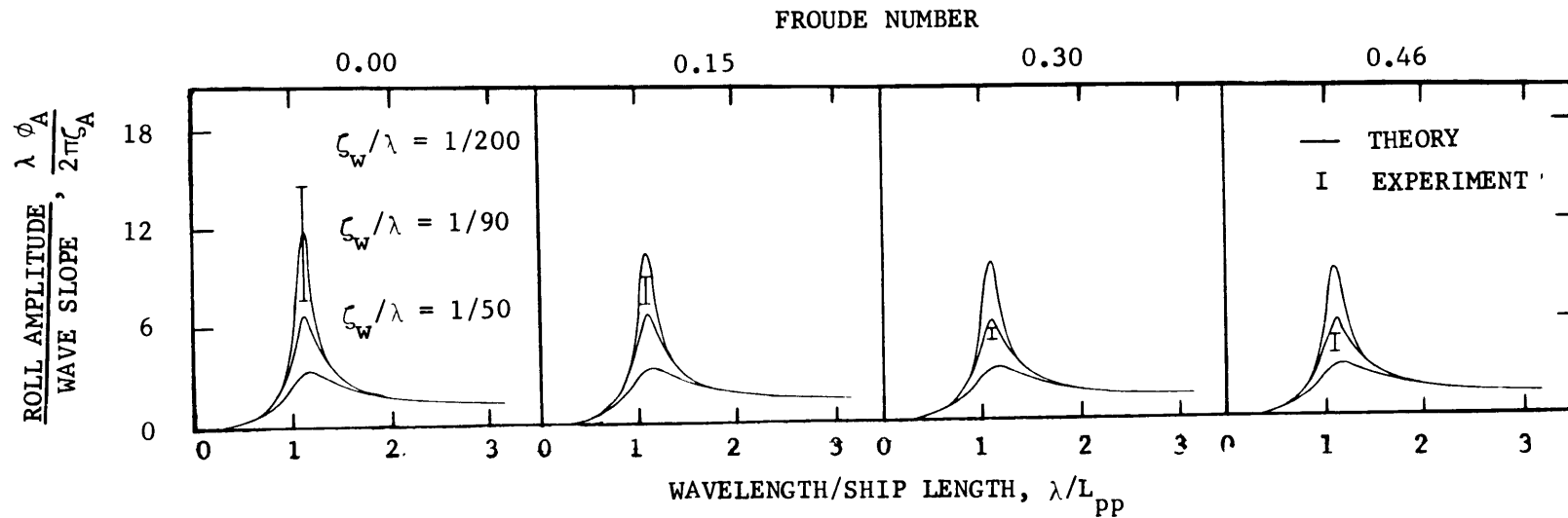

Figure 9b – Nondimensional Roll-Transfer Function versus Wave/Ship Lengths

Figure 9 – Comparison of Measured and Predicted Roll Response in Regular Beam Waves for a Destroyer Hull



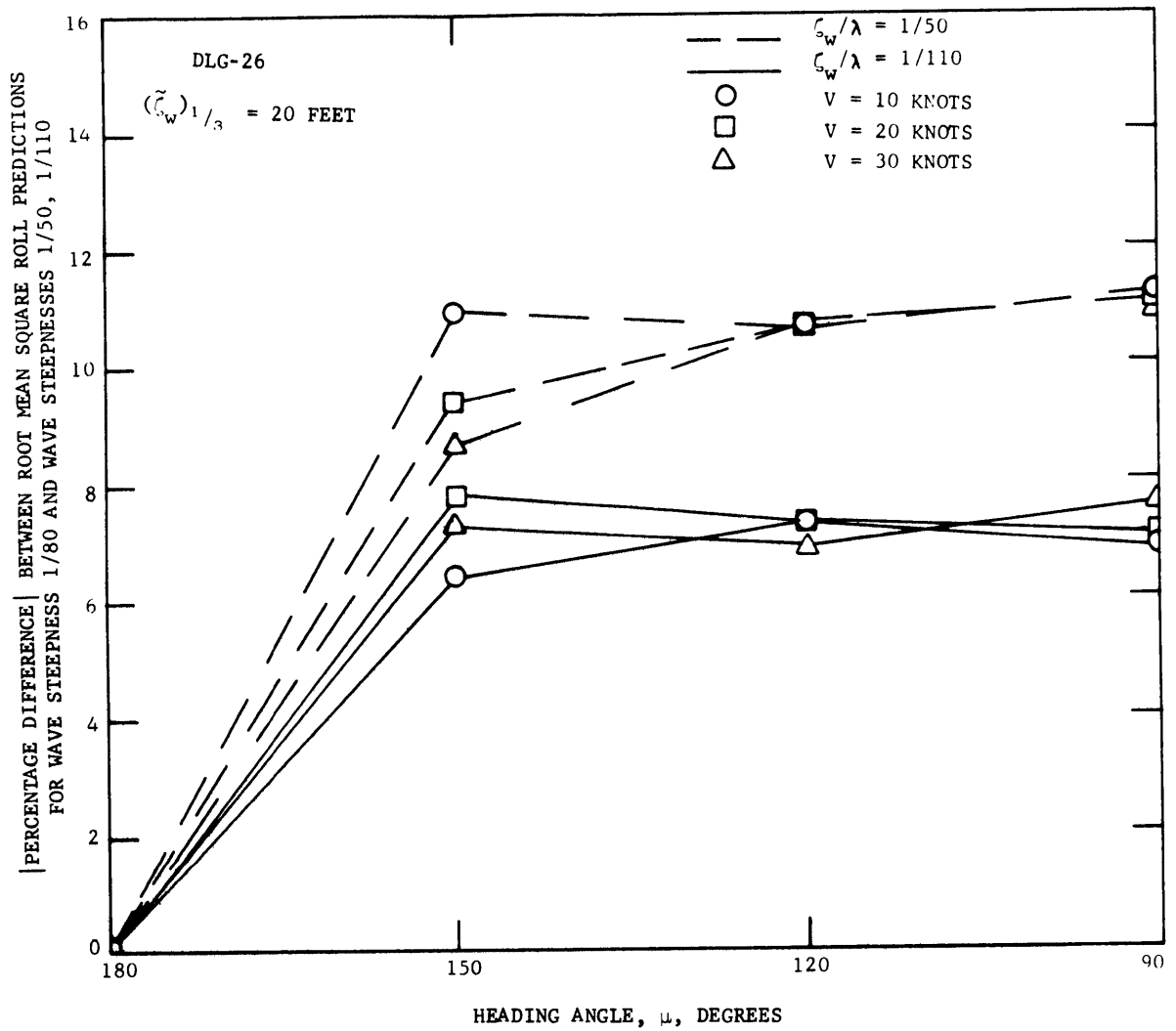

Figure 10 – Percentage Differences Between Roll Predictions at Wave Steepnesses 1/80 and 1/50 and 1/80 and 1/110 for the USS BELKNAP (DLG-26) in Irregular Seas

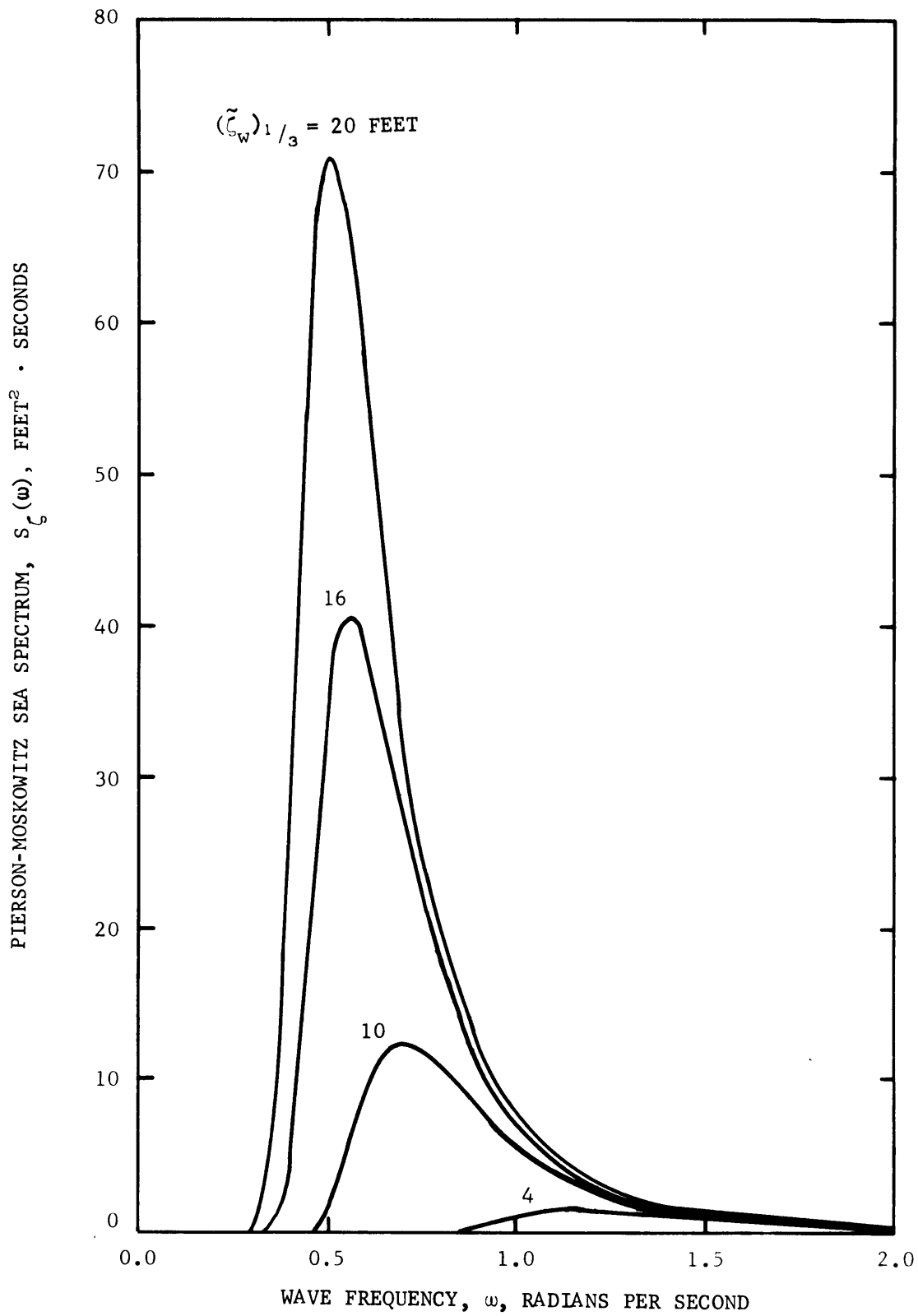

Figure 11 – Pierson and Moskowitz Sea Spectra for Significant Wave Heights of 4, 10, 16, and 20 Feet

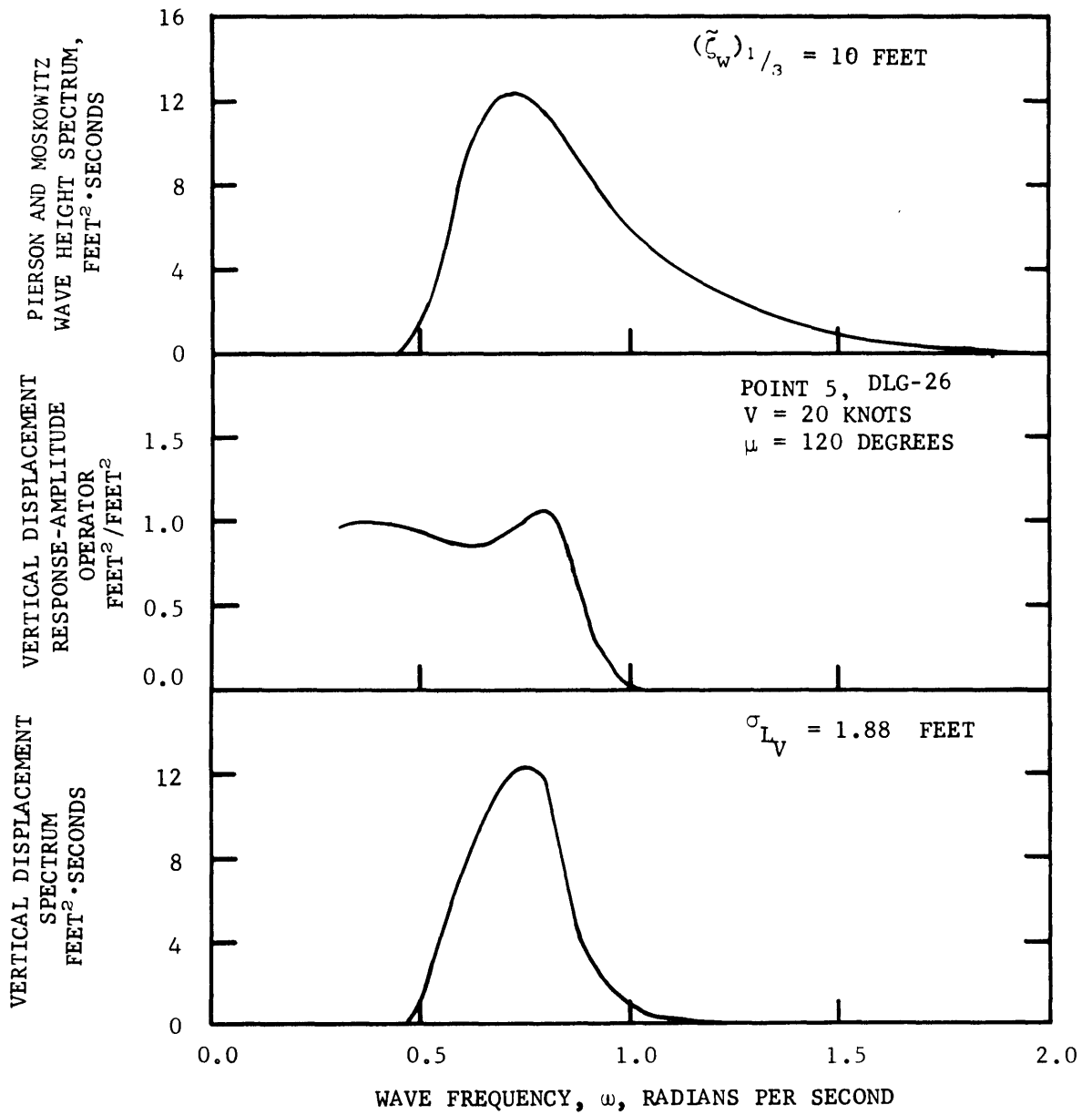

Figure 12 – Typical Response Spectrum and its Components for Vertical Displacement of Point 5 on BELKNAP for Significant Wave Height of 10 Feet and Ship Speed of 20 Knots

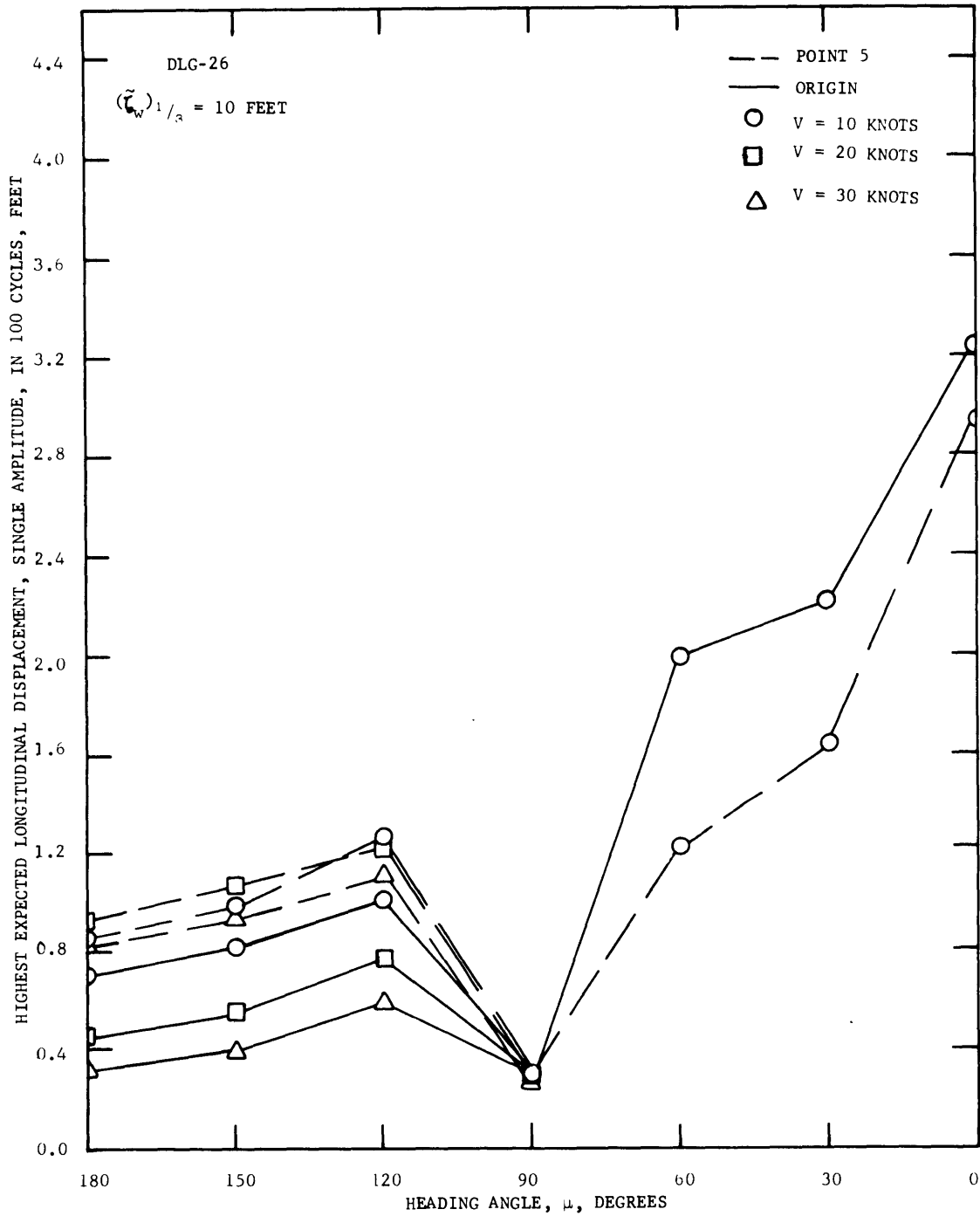

Figure 13 — Comparison of Highest Expected Longitudinal Displacement, Single Amplitudes, in 100 Cycles for Origin of BELKNAP and Point 5 with Significant Wave Height of 10 Feet

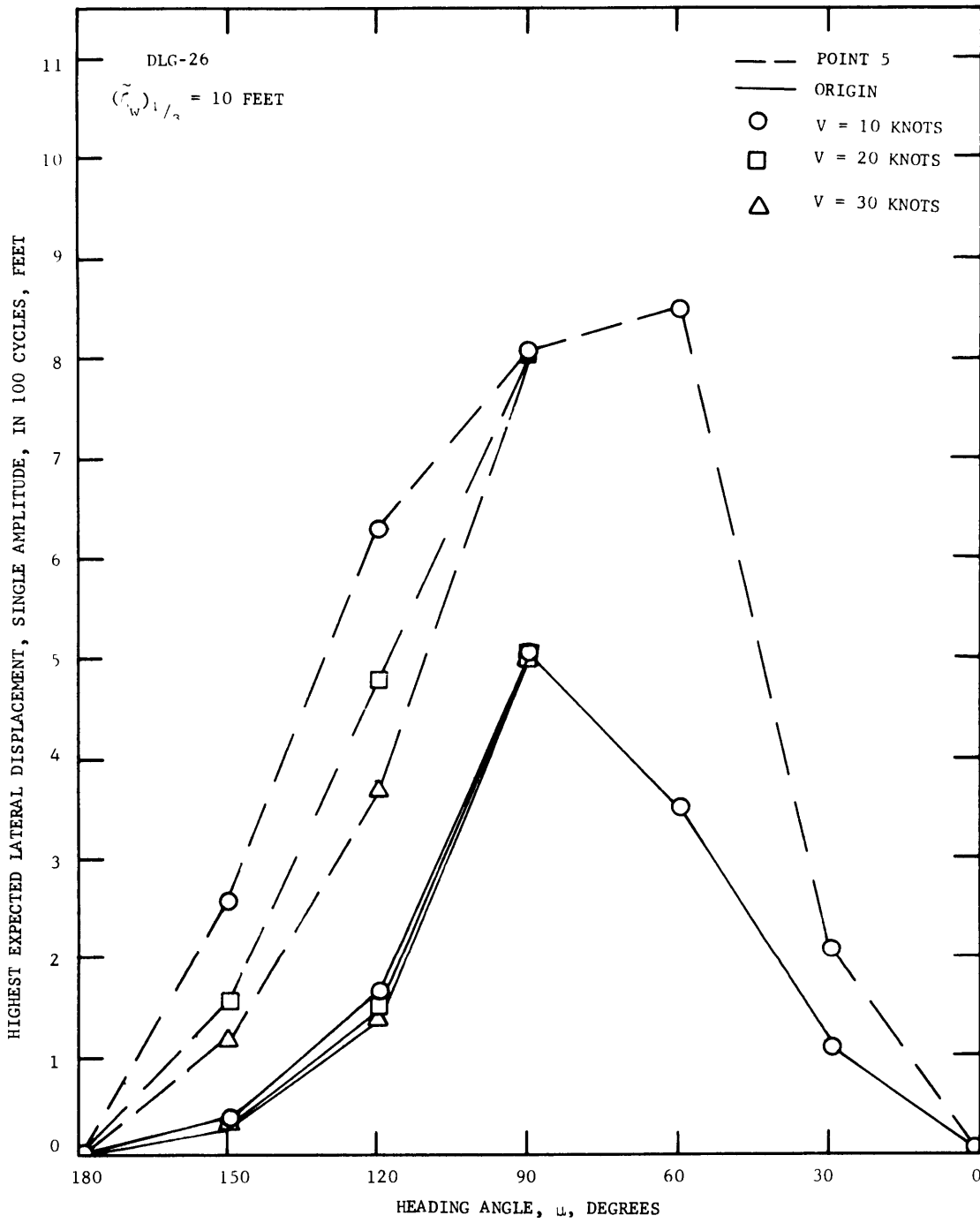

Figure 14 – Comparison of Highest Expected Lateral Displacement, Single Amplitudes, in 100 Cycles for Origin of BELKNAP and Point 5 with Significant Wave Height of 10 Feet

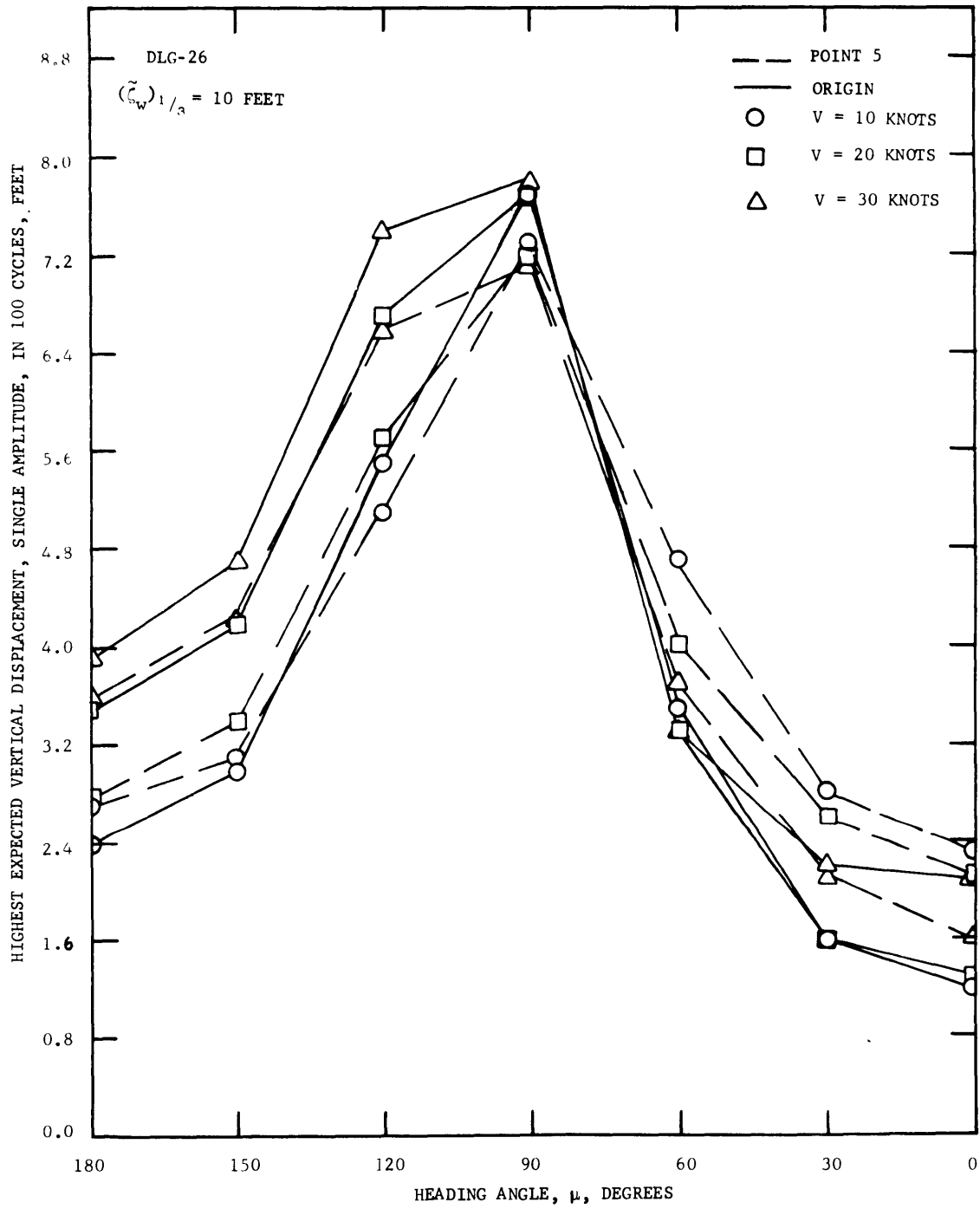

Figure 15 – Comparison of Highest Expected Vertical Displacement, Single Amplitudes, in 100 Cycles for Origin of BELKNAP and Point 5 with Significant Wave Height of 10 Feet

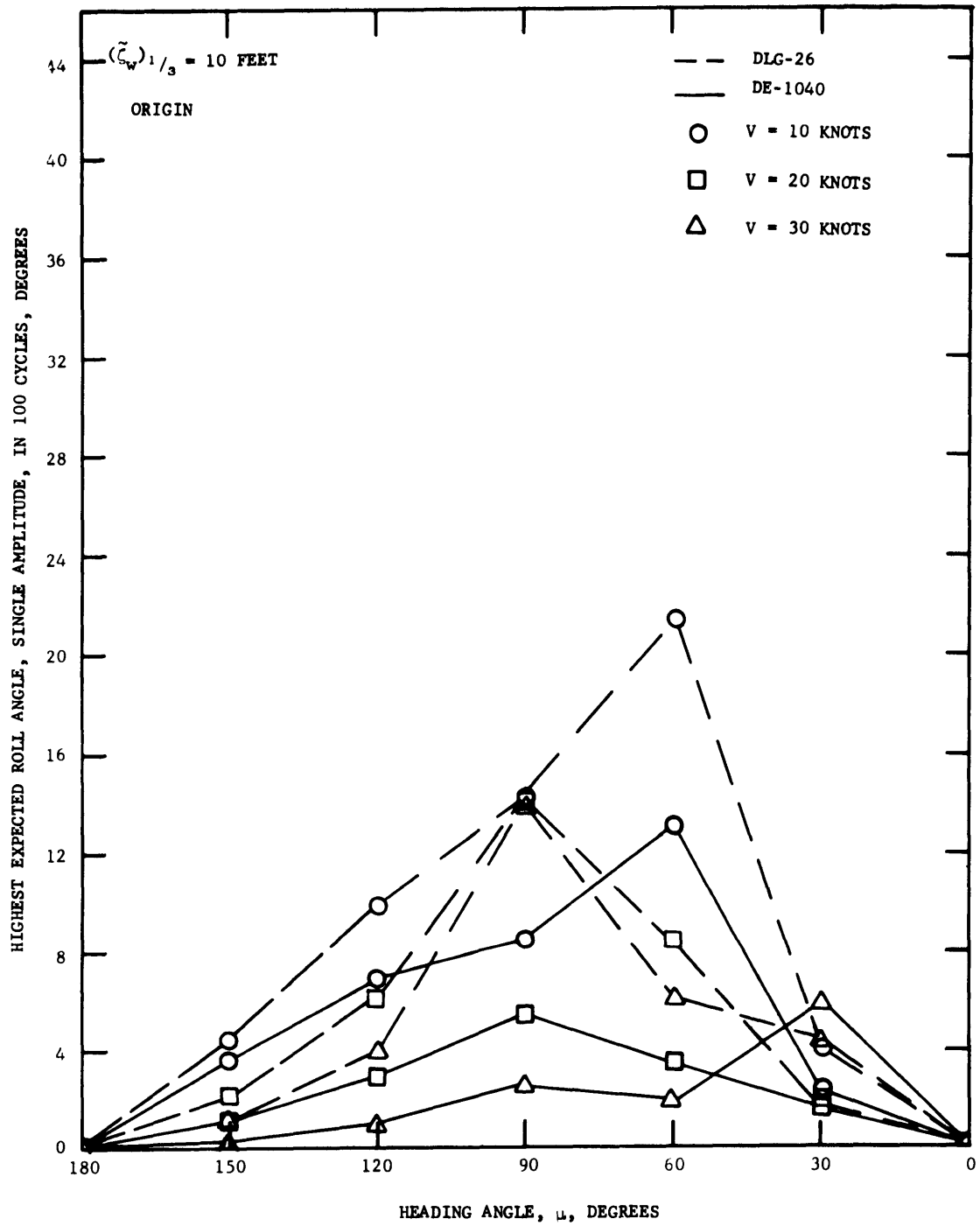

Figure 16 – Comparison of Highest Expected Roll, Single Amplitudes, in 100 Cycles for BELKNAP and GARCIA with Significant Wave Height of 10 Feet

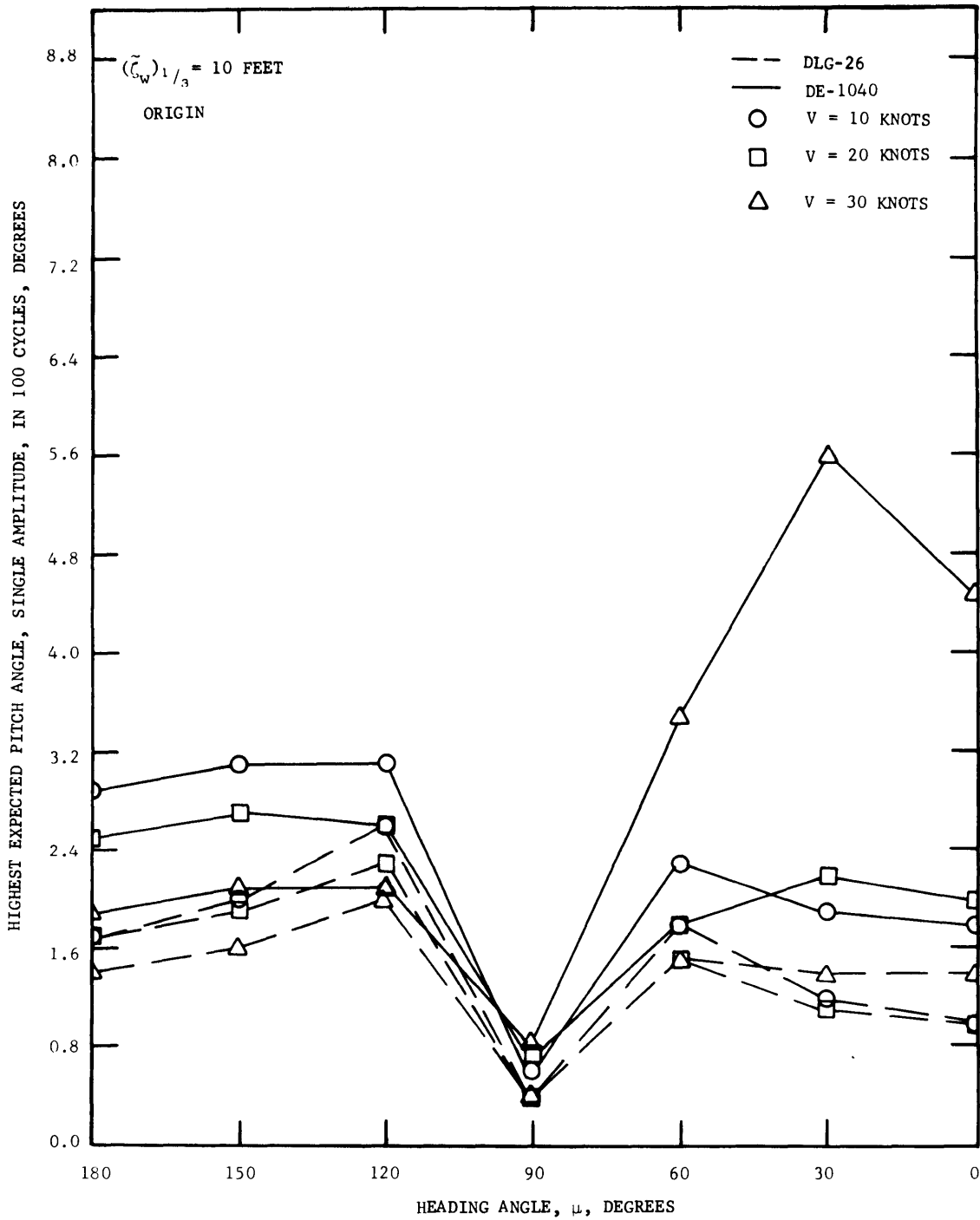

Figure 17 – Comparison of Highest Expected Pitch, Single Amplitudes, in 100 Cycles for BELKNAP and GARCIA with Significant Wave Height of 10 Feet



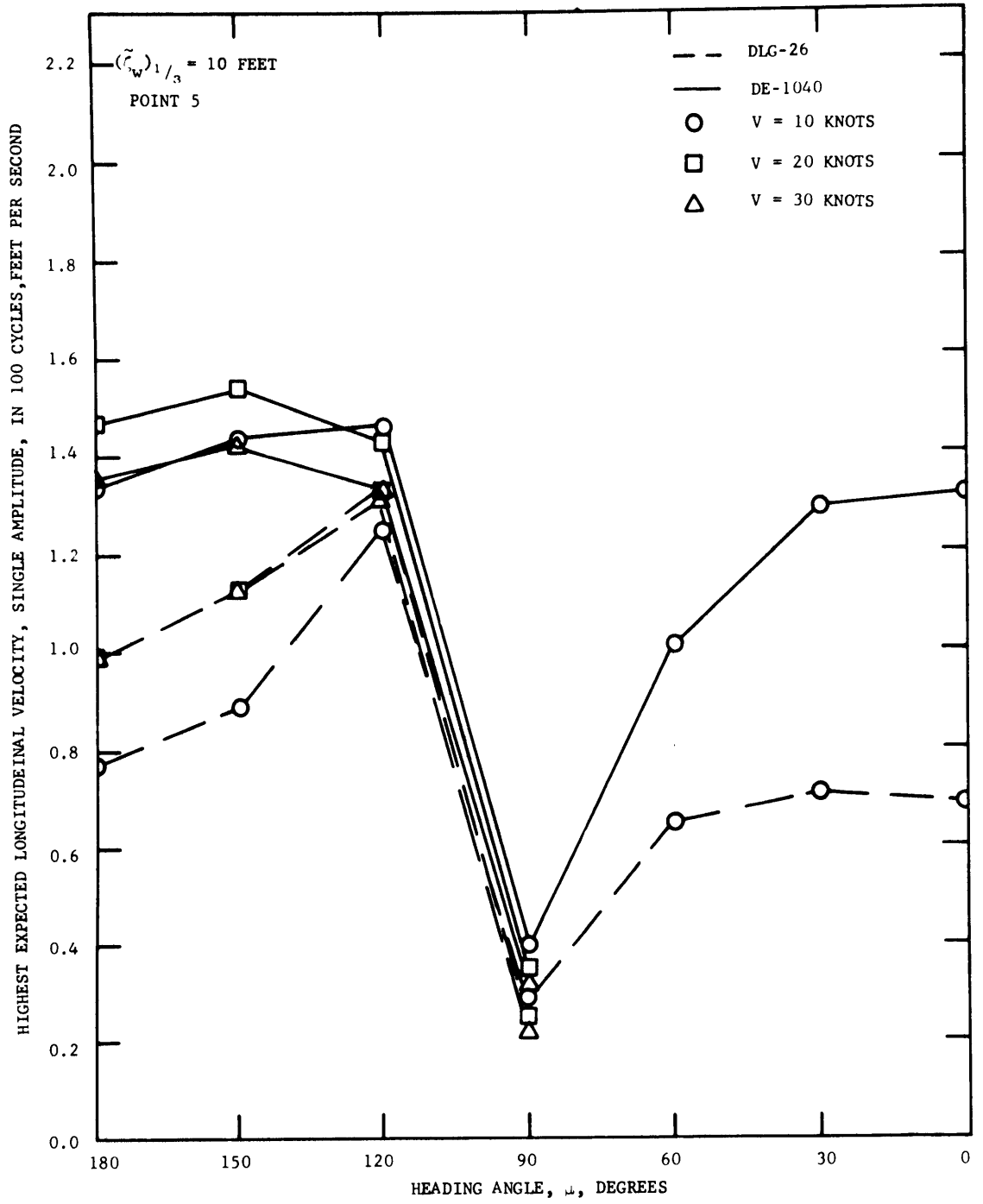

Figure 18 – Comparison of Highest Expected Longitudinal Velocity, Single Amplitudes, in 100 Cycles for BELKNAP and GARCIA with Significant Wave Height of 10 Feet

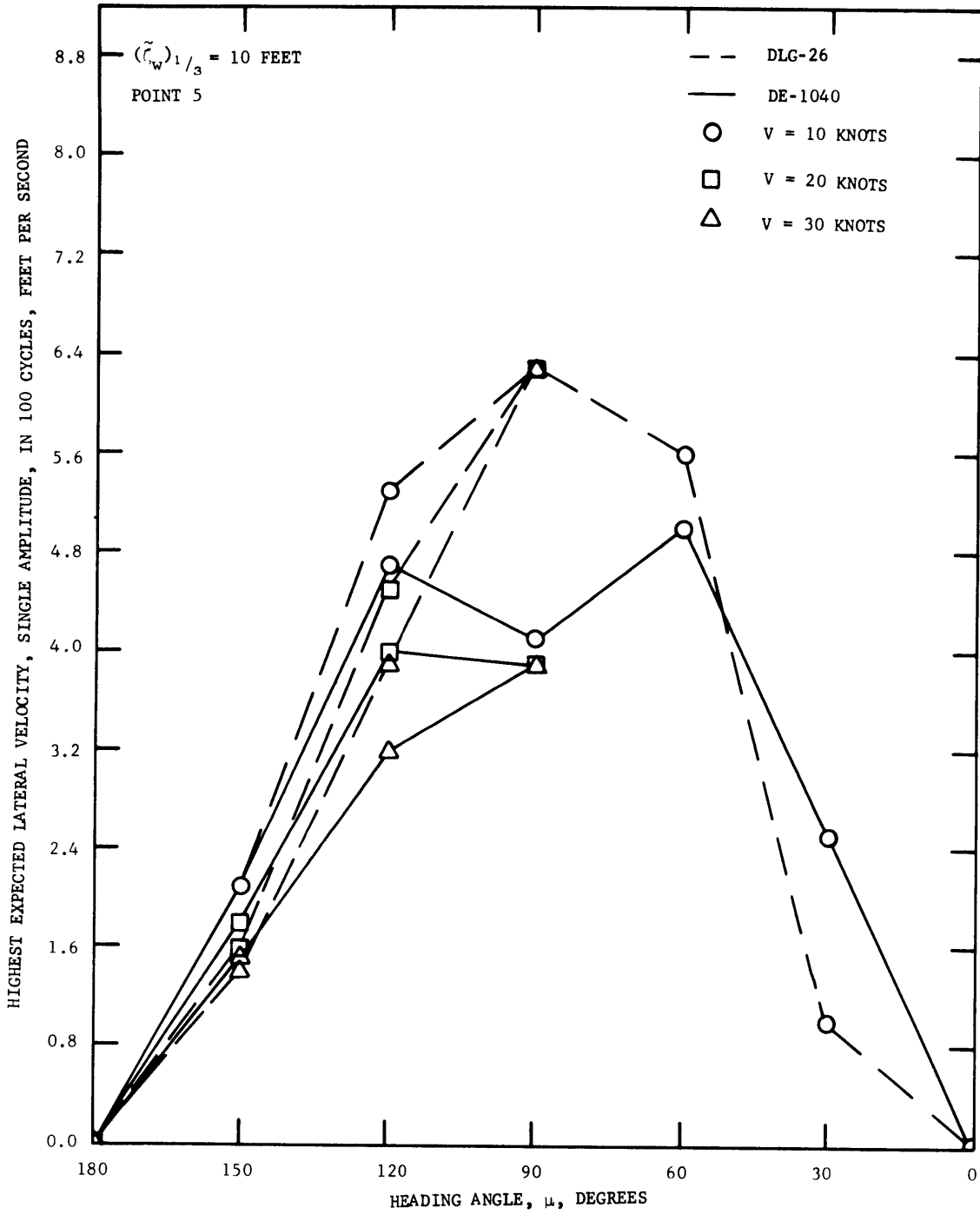

Figure 19 – Comparison of Highest Expected Lateral Velocity, Single Amplitudes, in 100 Cycles for BELKNAP and GARCIA with Significant Wave Height of 10 Feet

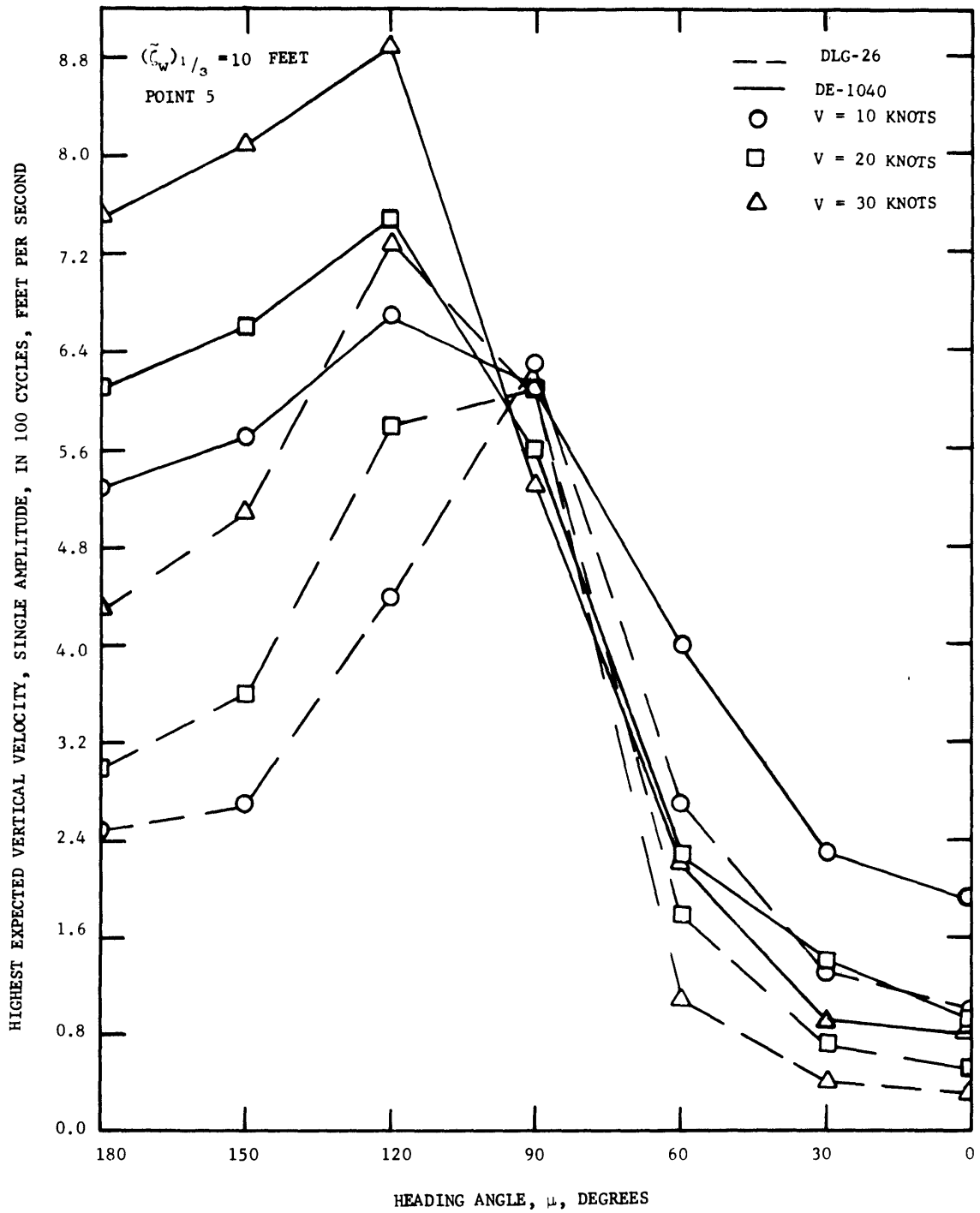

Figure 20 – Comparison of Highest Expected Vertical Velocity, Single Amplitudes, in 100 Cycles for BELKNAP and GARCIA with Significant Wave Height of 10 Feet

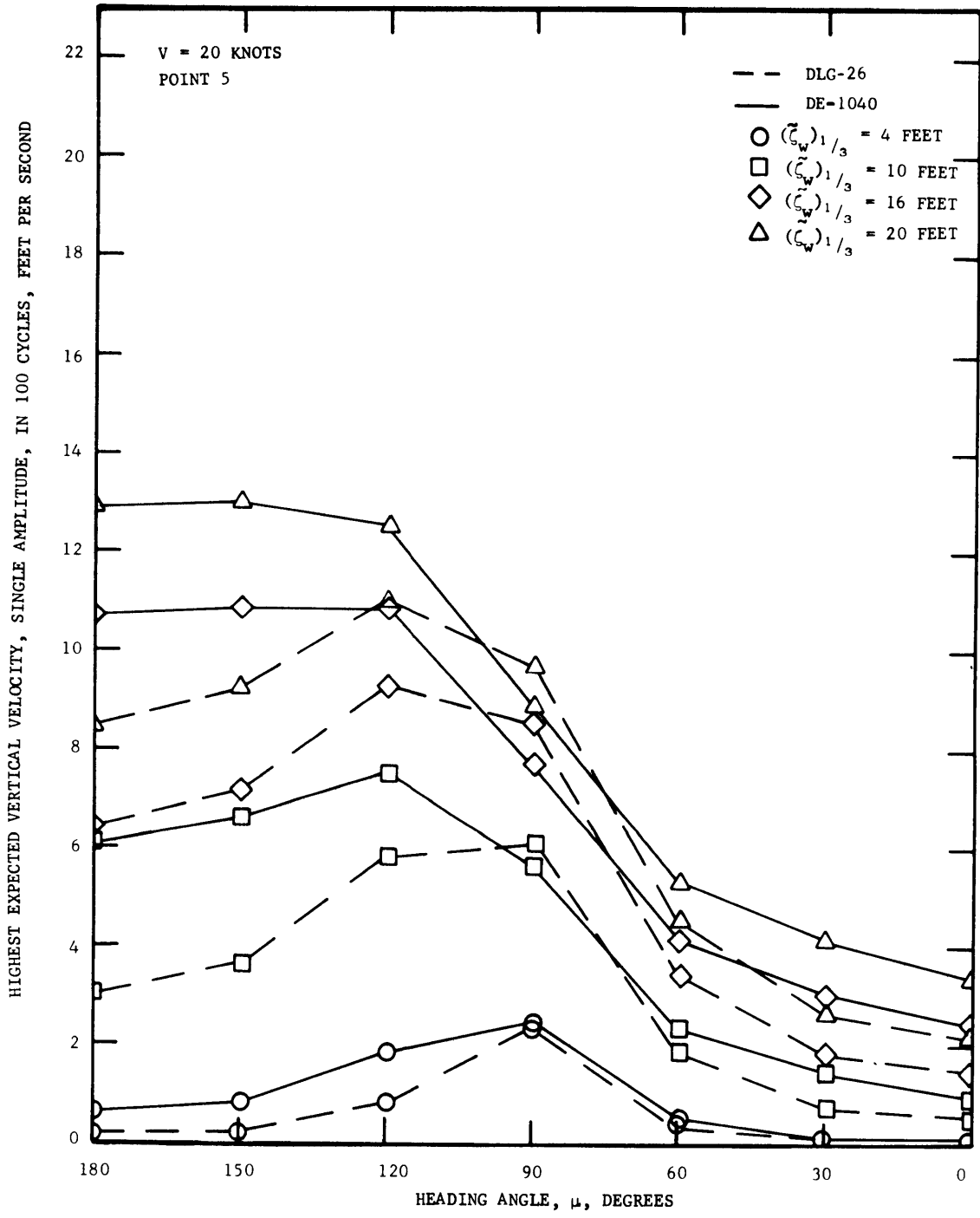

Figure 21 – Comparison of Highest Expected Vertical Velocity, Single Amplitudes, in 100 Cycles for BELKNAP and GARCIA at Point 5 and 20 Knots

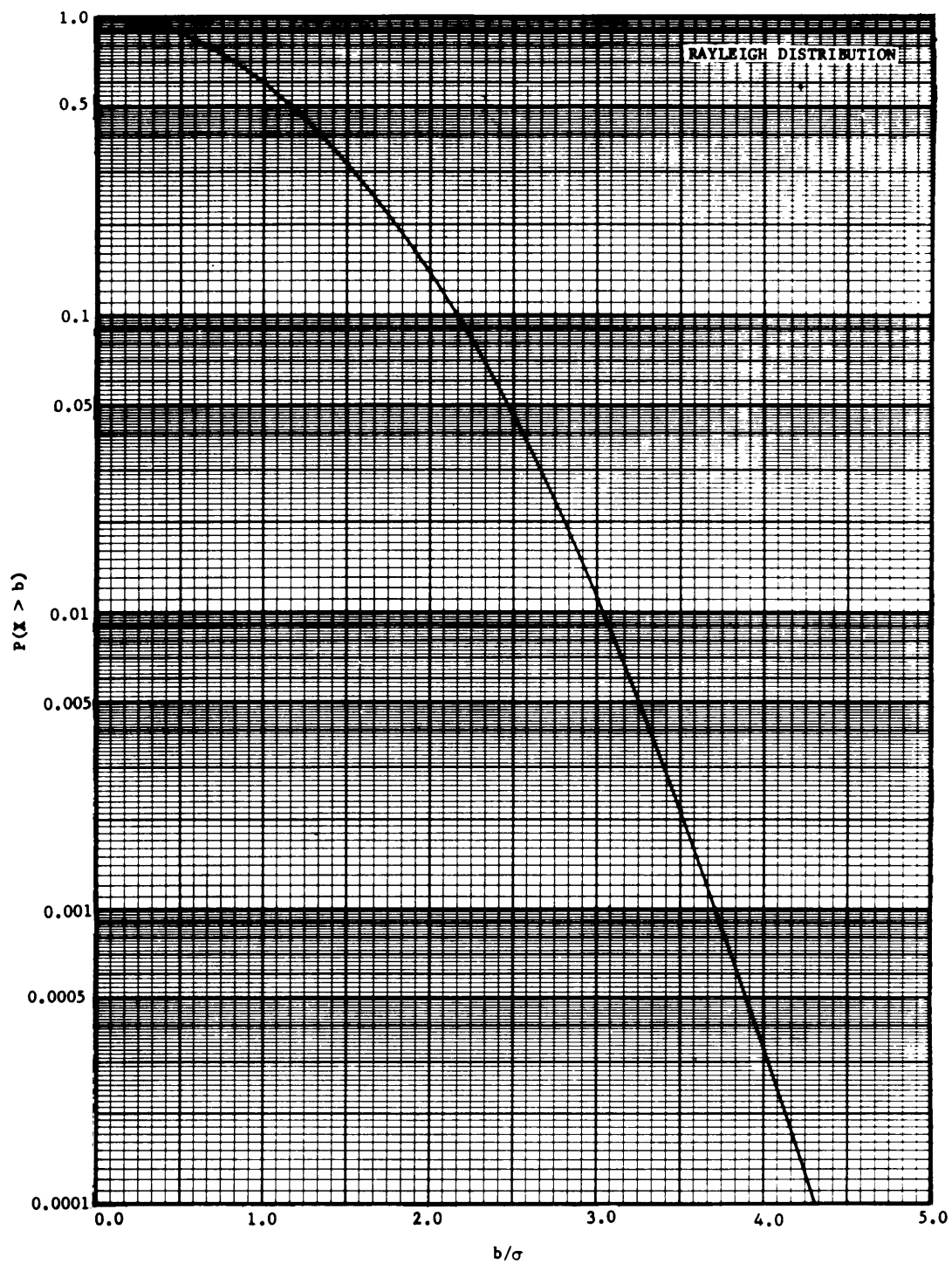

Figure 22 – The Probability  $P$  of  $X$  Exceeding  $b$ , Given  $\sigma$

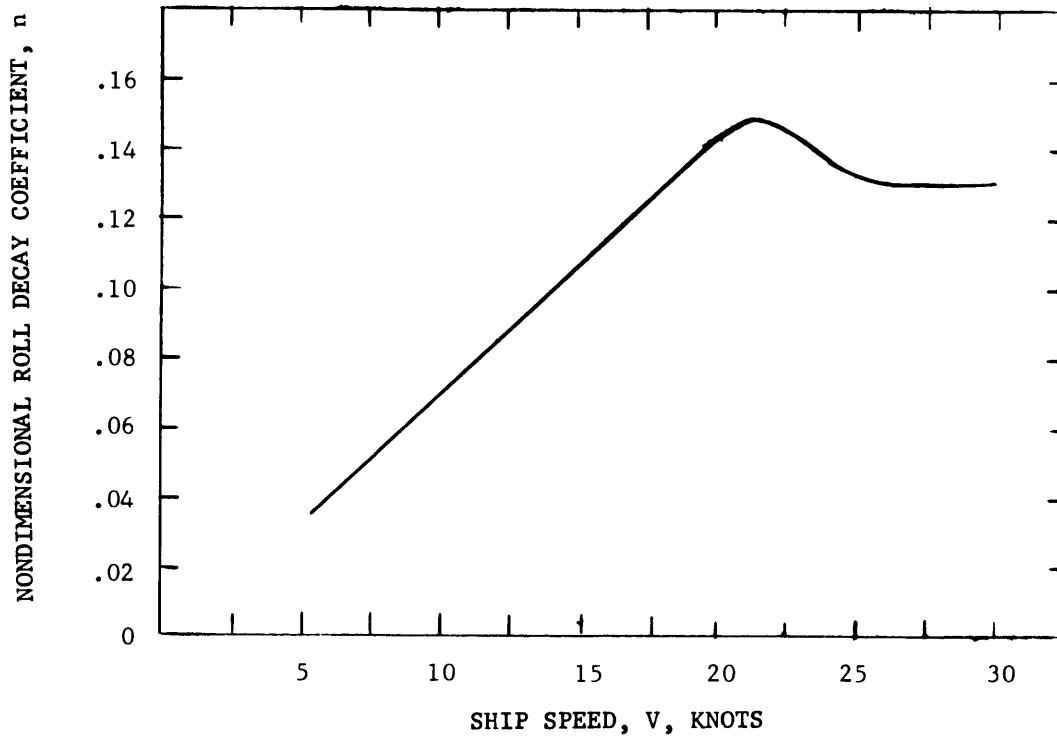

Figure 23 – Nondimensional Roll-Decay Coefficient of GARCIA

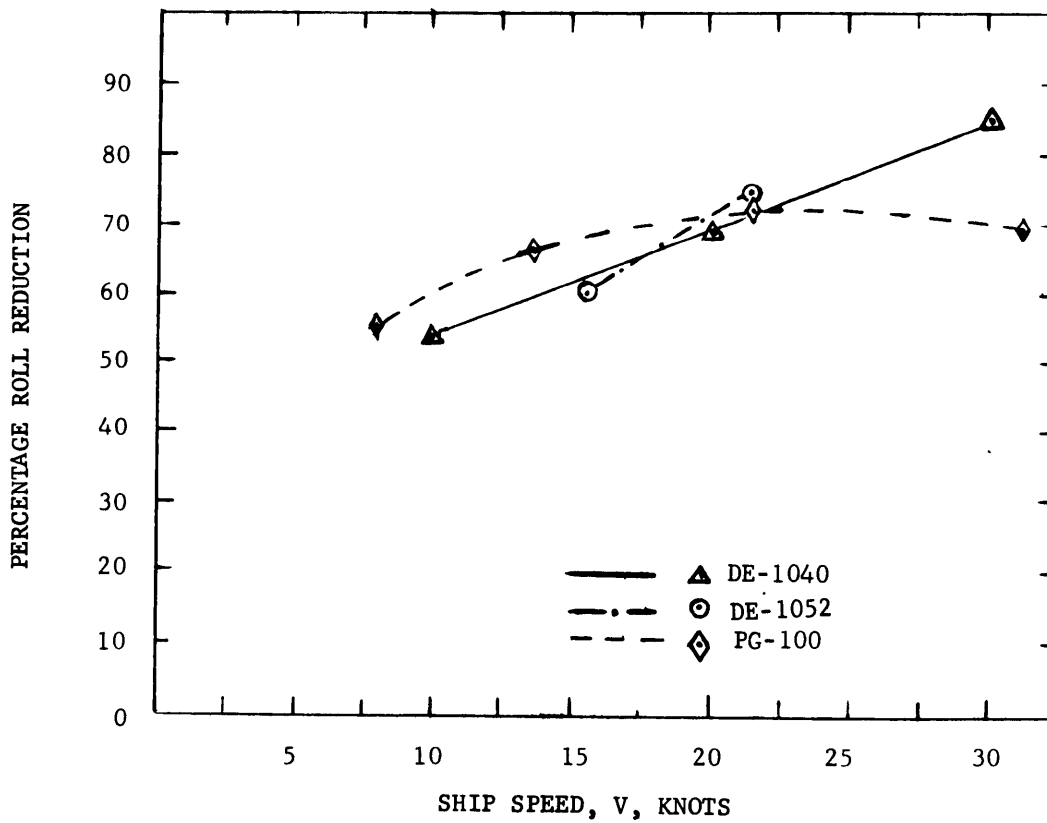

Figure 24 – Percentage of Roll Reduction for Stabilized GARCIA and Experimental Comparison with Two Other Ships

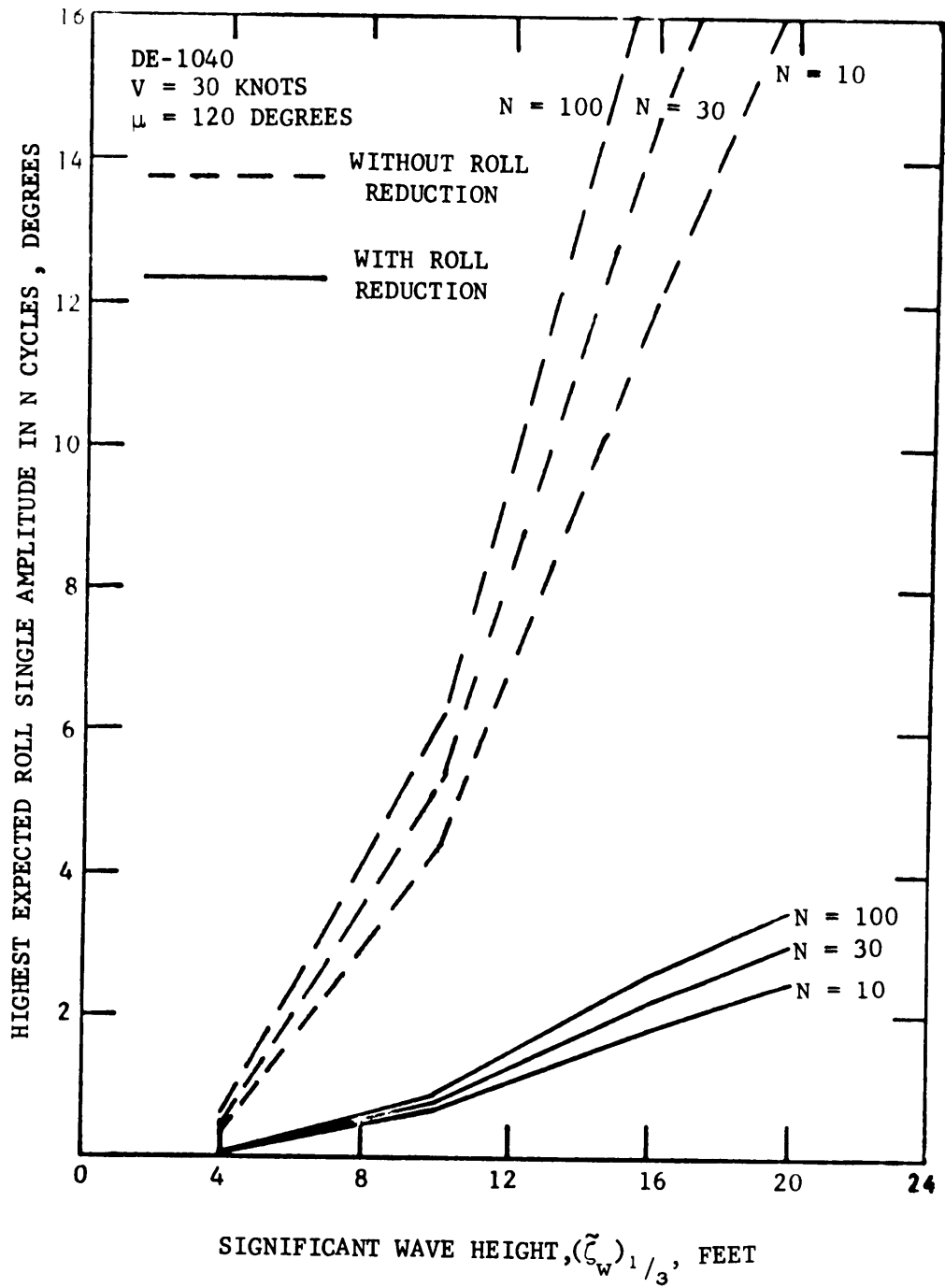

Figure 25 – Comparison of Highest Expected Roll, Single Amplitudes, in  $N$  Cycles for GARCIA with and without Roll Reduction for 30 Knots and a 120-Degree Heading Angle





## APPENDIX A

### PROBABILITY OF OCCURRENCE

The probability of occurrence of a particular response, i.e., displacement, velocity, or acceleration, over a long period of time can be determined from the area of the corresponding response spectra. The peak-to-peak double amplitudes of response, and hence the single amplitudes, are assumed to be very nearly distributed with a Rayleigh probability density function, which is given by

$$f(x) = \frac{x}{\sigma^2} \exp \left[ -\frac{x^2}{2\sigma^2} \right] \text{ for } 0 \leq x \quad (17)$$

= 0 otherwise

The distribution function  $F(x)$  is obtained from  $f(x)$  by

$$F(x) = \int_0^x f(x) dx = 1 - \exp \left[ -\frac{x^2}{2\sigma^2} \right] \quad (18)$$

This can be used to obtain the probability of  $X > b$ , i.e.,  $P(X > b)$  by

$$P(X > b) = 1 - F(b) = \exp \left[ -\frac{b^2}{2\sigma^2} \right] \quad (19)$$

The Rayleigh distribution is plotted in Figure 22 against  $b/\sigma$ . Thus, the probability of  $X$  exceeding a specific  $b$  can be read directly from the curve. For example, consider the vertical velocity of Point 5 on BELKNAP with a heading of 120 deg, 30 knots, and a State 5 sea; see Figure 20. The highest value in 100 cycles is 7.30 ft/sec. The corresponding root mean square or  $\sigma_{L_V}$  value is 2.41 ft/sec. To determine the probability of exceeding 6 ft/sec over a long period look up the ratio of 6 to 2.41 or 2.49, which corresponds to 0.046 on the vertical scale of Figure 22. Thus the probability of exceeding 6 ft/sec is 0.046 or 4.6 per cent.

There is another use of Figure 22 that should be mentioned. Suppose, for the case described previously, it is desirable to know what vertical velocity  $b$  will be exceeded with a probability of 0.001 over a long period. In Figure 22,  $P = 0.001$  yields  $b/\sigma = 3.72$ . Therefore,  $b = 8.96$  ft/sec.

It is appropriate to make further comment about the single amplitude statistics in Table 3. Consider a large number  $N$  of values, each with equal probability  $1/N$  of being the maximum or highest value. From Equation (19)

$$b = \sqrt{2} \sigma [\ln 1/P]^{1/2} \quad (20)$$

or

$$b = \sqrt{2} \sigma [\ln N]^{1/2}$$

Equation (20) means that  $b$  is the highest value most likely to occur in  $N$  values. This definition is exactly that of Table 3.

A few words of warning are necessary. There is no upper limit on the highest response  $b$  that can be predicted by Equation (20). That is, as  $N$  becomes large,  $b$  becomes large. Therefore, Equation (20), and hence the definition in Table 3, is best applied for small values of  $N$ .

Reference 8 gives additional procedures for developing response statistics.

---

<sup>8</sup>Pierson, W.J., Jr. et al., "Practical Methods for Observing and Forecasting Ocean Waves by Means of Wave Spectra and Statistics," U.S. Navy Hydrographic Office Publication 603 (1955).

**APPENDIX B**  
**ROLL REDUCTION OF USS GARCIA (DE-1040) BY ACTIVE STABILIZING FINS**

The linear theory of J.E. Conolly<sup>9</sup> has been used to predict the reduction in roll due to a pair of active fins fitted to GARCIA. To apply the Conolly theory, it is necessary to obtain an expression for  $\phi_s/\phi_u$ , the ratio of stabilized to unstabilized roll, as a function of the ship and fin particulars. As not all of the required particulars are known, certain quantities must be assumed or estimated from existing data.

It is assumed that the fin-control system seeks to completely oppose the roll angle imposed by the wave on the ship. The system regulating the fin angle  $\beta$  is described by

$$\beta = k_1 \phi + k_2 \dot{\phi} + k_3 \ddot{\phi} \quad (21)$$

where for opposed control

$$\frac{k_3}{k_2} = \frac{1}{2n\omega_\phi}$$

and

$$\frac{k_1}{k_2} = \frac{\omega_\phi}{2n} \quad (22)$$

where  $k_1$ ,  $k_2$ , and  $k_3$  are the control characteristics of the system

$\phi$  is the roll angle

$\omega_\phi$  is the natural frequency of roll in radians per second and

$n$  is the roll-decay coefficient.

The ratio of stabilized-to-unstabilized roll amplitude may be estimated by

$$\frac{\phi_s}{\phi_u} = \left[ 1 + \frac{\rho A_F R_F \omega_\phi}{2 \Delta \overline{GM}} \left( \frac{dC_L}{d\beta} \right) \frac{V^2}{n} k_2 \right]^{-1} \quad (23)$$

---

<sup>9</sup>Conolly, J.E., "Rolling and its Stabilization by Active Fins," Quarterly Transactions of The Royal Institution of Naval Architects, Vol. 3, No. 1, pp. 21-48 (1969).

where  $\rho$  is the mass density of water, 1.99 slugs/ft<sup>3</sup>  
 $V$  is ship speed in feet per second  
 $\Delta$  is ship displacement in pounds  
 $\overline{GM}$  is metacentric height in feet  
 $R_F$  is distance from the center of pressure of the fin to the roll axis in feet  
 $A_F$  is fin area per side of ship in square feet  
 $dC_L/d\beta$  is slope of lift-coefficient curve per radian of fin angle.

From Figure 4,  $A_F = 32 \text{ ft}^2$ , and  $R_F = 20.6 \text{ ft}$ . From Table 1,  $\Delta = 3408 \text{ long tons}$ ,  $\overline{GM} = 4.5 \text{ ft}$ , and  $\omega_\phi = 0.7 \text{ rad/sec}$ . To apply Equation (23), it remains to determine values for  $dC_L/d\beta$ ,  $n$ , and  $k_2$ .

It is assumed that the fin-lift coefficient  $C_L$  is linearly proportional to the fin angle  $\beta$ , so that the slope of the lift-coefficient curve is<sup>10</sup>

$$\frac{dC_L}{d\beta} = 5.65 (2 a_g) \left[ \sqrt{(2 a_g)^2 + 4} + 1.8 \right]^{-1} \quad (24)$$

$$\approx 3.6 \text{ per radian of fin angle}$$

where  $a_g$  is the geometric aspect ratio.

To obtain an estimate for the roll-decay coefficients of GARCIA, it is assumed that they can be calculated from those measured full scale for the USS BRUMBY (DE-1044) by the relationship

$$\frac{n_{1040}}{n_{1044}} = \frac{\Delta_{1044}}{\Delta_{1040}} \cdot \frac{\omega_\phi 1044}{\omega_\phi 1040} \quad (25)$$

where the subscripts 1040 and 1044 refer to the ships.<sup>9</sup> Figure 23 gives the resulting decay coefficients as a function of ship speed. The values for the particular speeds under consideration are as follows:

Ship Speed knots	Decay Coefficient, $n$
10	0.069
20	0.145
30	0.131

<sup>10</sup>Whicker, L.F. and L.F. Fehlner, "Free-Stream Characteristics of a Family of Low-Aspect-Ratio, All-Movable Control Surfaces for Application to Ship Design," David Taylor Model Basin Report 933 (Dec 1958).

It remains only to find a value for  $k_2$ . Reference 9 gives 4.2 and 6.6 for ship systems of two specific destroyer types. It seems reasonable, therefore, to put  $k_2 = 5$ . It will be shown later from both model and full-scale experiments that this value gives a roll reduction of the right order of magnitude.

Using ship speeds corresponding to 10, 20, and 30 knots, Equation 23 yields

Ship Speed knots	$\phi_s/\phi_u$	Percentage Roll Reduction
10	0.4595	54
20	0.3087	69
30	0.1521	85

where the percentage of roll reduction is merely  $100(1-\phi_s/\phi_u)$  percent.

These numbers are representative of the type of roll reduction experienced by ships fitted with active fins as may be seen from Figure 24, which gives the percentage of roll reduction for GARCIA together with experimental results for two other ships. The diamonds represent the percentage of roll reduction observed during full-scale trials by the Center onboard a patrol gun boat 154 ft in length, having a Froude correction factor to speed of 1.59. The circles represent the percentage of roll reduction measured during tests by the Center of a USS KNOX (DE-1052)-Class model, 415 ft in length, having a fin-control system dependent on angle and velocity of roll and a corresponding Froude correction factor of 0.97. This implies that using the previously given equations, based on linear roll theory with  $k_2 = 5$ , gives an estimate of roll reduction which is compatible with data both from model and full-scale tests for ships of similar characteristics to those of GARCIA.

In comparing roll angles for the unstabilized GARCIA with those estimated for the ship fitted with fins, Figure 25 shows significant values against wave height at 30 knots and a 120-deg heading angle. Single amplitudes are shown for the highest wave in 10, 30, and 100 cycles of response. The figure expresses the dramatic difference in unstabilized and stabilized roll angles.



**APPENDIX C**  
**SUMMARIES OF INVESTIGATIONS**

TABLE 6 - BELKNAP, ORIGIN, ROOT-MEAN-SQUARE SURGE RESPONSE, SINGLE AMPLITUDES

		SURGE SINGLE AMPLITUDES FOR THE DLG - 26 (INTERSECTION OF WATERPLANE AND LCG)											
		ROOT MEAN SQUARE AMPLITUDE											
HEADING	SHIP	SIG. WAVE HT. = 4 FT			SIG. WAVE HT. = 10 FT			SIG. WAVE HT. = 16 FT			SIG. WAVE HT. = 20 FT		
ANGLE	SPEED	DISPL.	VEL.	ACCEL.	DISPL.	VEL.	ACCEL.	DISPL.	VEL.	ACCEL.	DISPL.	VEL.	ACCEL.
(DEG)	(KNOTS)	(FT)	(FT/SEC)	(G)	(FT)	(FT/SEC)	(G)	(FT)	(FT/SEC)	(G)	(FT)	(FT/SEC)	(G)
180	10	.00	.01	.000	.23	.18	.004	.81	.53	.012	1.30	.79	.016
	20	.00	.00	.000	.15	.14	.004	.55	.44	.011	.91	.66	.016
	30	.00	.00	.000	.10	.11	.004	.40	.37	.011	.67	.56	.016
150	10	.01	.01	.000	.27	.21	.005	.84	.56	.012	1.30	.79	.016
	20	.00	.01	.000	.18	.17	.005	.59	.46	.012	.94	.67	.016
	30	.00	.01	.000	.13	.14	.005	.44	.39	.012	.71	.58	.016
120	10	.03	.03	.001	.33	.27	.007	.77	.52	.012	1.08	.67	.014
	20	.02	.02	.001	.25	.23	.007	.60	.46	.012	.86	.60	.014
	30	.01	.02	.001	.19	.20	.007	.48	.40	.012	.71	.53	.014
90	10	.02	.02	.001	.10	.07	.002	.21	.13	.003	.30	.17	.003
	20	.02	.02	.001	.10	.07	.002	.21	.13	.003	.31	.17	.003
	30	.02	.02	.001	.10	.07	.002	.21	.13	.003	.31	.17	.003
60	10	.06	.04	.001	.66	.37	.006	1.48	.73	.012	2.06	.96	.015
	20	--	--	--	--	--	--	--	--	--	--	--	--
	30	--	--	--	--	--	--	--	--	--	--	--	--
30	10	.06	.03	.000	.73	.32	.004	2.13	.86	.011	3.19	1.23	.015
	20	--	--	--	--	--	--	--	--	--	--	--	--
	30	--	--	--	--	--	--	--	--	--	--	--	--
0	10	.77	.05	.000	1.08	.29	.004	2.43	.86	.010	3.62	1.28	.015
	20	--	--	--	--	--	--	--	--	--	--	--	--
	30	--	--	--	--	--	--	--	--	--	--	--	--



TABLE 7 - BELKNAP, ORIGIN, ROOT-MEAN-SQUARE SWAY RESPONSE, SINGLE AMPLITUDES

		SWAY SINGLE AMPLITUDES FOR THE DLG - 26 (INTERSECTION OF WATERPLANE AND LCG)											
		ROOT MEAN SQUARE AMPLITUDE											
*HEADING* *ANGLE	*SHIP *SPEED	* SIG. WAVF HT. = 4 FT **			* SIG. WAVF HT. = 10 FT **			* SIG. WAVE HT. = 16 FT **			* SIG. WAVE HT. = 20 FT **		
		*DISPL.*	*VEL.*	*ACCEL.*	*DISPL.*	*VEL.*	*ACCEL.*	*DISPL.*	*VEL.*	*ACCEL.*	*DISPL.*	*VEL.*	*ACCEL.*
(DEG)	(KNOTS)	(FT)	(FT/SEC)	(G)	(FT)	(FT/SEC)	(G)	(FT)	(FT/SEC)	(G)	(FT)	(FT/SEC)	(G)
	10	0.00	0.00	0.000	0.00	0.00	0.000	0.00	0.00	0.000	0.00	0.00	0.000
	20	0.00	0.00	0.000	0.00	0.00	0.000	0.00	0.00	0.000	0.00	0.00	0.000
	30	0.00	0.00	0.000	0.00	0.00	0.000	0.00	0.00	0.000	0.00	0.00	0.000
	10	.01	.02	.001	.14	.11	.003	.57	.35	.007	.98	.56	.011
	20	.01	.01	.001	.11	.11	.004	.43	.32	.008	.76	.50	.011
	30	.00	.01	.001	.10	.10	.004	.36	.31	.009	.61	.48	.013
	10	.04	.06	.002	.58	.44	.011	1.65	1.03	.022	2.50	1.44	.028
	20	.03	.05	.002	.51	.45	.013	1.41	1.00	.025	2.16	1.39	.031
	30	.03	.04	.002	.45	.45	.015	1.22	.98	.027	1.87	1.34	.034
	10	.37	.42	.016	1.64	1.28	.035	3.24	2.07	.048	4.34	2.54	.054
	20	.37	.42	.016	1.65	1.29	.035	3.27	2.09	.048	4.37	2.56	.054
	30	.36	.41	.015	1.67	1.29	.035	3.30	2.11	.048	4.39	2.58	.054
	10	.10	.07	.002	1.16	.64	.011	2.60	1.29	.021	3.60	1.68	.026
	20	--	--	--	--	--	--	--	--	--	--	--	--
	30	--	--	--	--	--	--	--	--	--	--	--	--
	10	.09	.02	.000	.37	.16	.002	1.07	.43	.005	1.62	.62	.008
	20	--	--	--	--	--	--	--	--	--	--	--	--
	30	--	--	--	--	--	--	--	--	--	--	--	--
	10	.00	.00	.000	.00	.00	.000	.00	.00	.000	.00	.00	.000
	20	.00	.00	.000	.00	.00	.000	.00	.00	.000	.00	.00	.000
	30	.00	.00	.000	.00	.00	.000	.00	.00	.000	.00	.00	.000

TABLE 8 - BELKNAP, ORIGIN, ROOT-MEAN-SQUARE HEAVE RESPONSE, SINGLE AMPLITUDES

*****													
HEAVE													
SINGLE AMPLITUDES FOR THE DLG - 26													
(INTERSECTION OF WATERPLANE AND LCG)													
*****													
HEADING*	SHIP	ROOT MEAN SQUARE AMPLITUDE											
ANGLE*	SPEED	SIG. WAVE HT. = 4 FT			SIG. WAVE HT. = 10 FT			SIG. WAVE HT. = 16 FT			SIG. WAVE HT. = 20 FT		
		DISPL.	VEL.	ACCEL.	DISPL.	VEL.	ACCEL.	DISPL.	VEL.	ACCEL.	DISPL.	VEL.	ACCEL.
		(FT)	(FT/SEC)	(G)	(FT)	(FT/SEC)	(G)	(FT)	(FT/SEC)	(G)	(FT)	(FT/SEC)	(G)
(DEG)	(KNOTS)												
*****													
180	10	.07	.08	.003	.78	.72	.022	2.00	1.48	.038	2.93	1.97	.046
	20	.03	.04	.002	1.15	1.18	.039	2.87	2.63	.079	3.97	3.39	.098
	30	.01	.03	.002	1.27	1.45	.053	3.59	3.73	.126	4.98	4.90	.159
*****													
150	10	.07	.09	.004	.97	.86	.025	2.31	1.71	.043	3.30	2.22	.052
	20	.04	.06	.003	1.40	1.43	.047	3.18	2.90	.087	4.29	3.63	.104
	30	.02	.04	.002	1.56	1.77	.064	3.89	3.99	.134	5.23	5.08	.164
*****													
120	10	.24	.27	.009	1.81	1.63	.048	3.38	2.58	.068	4.42	3.08	.076
	20	.20	.25	.010	2.21	2.22	.073	4.01	3.53	.106	5.09	4.15	.118
	30	.14	.18	.008	2.43	2.63	.092	4.53	4.39	.142	5.70	5.17	.161
*****													
90	10	.74	.81	.029	2.55	2.18	.063	4.15	3.00	.078	5.18	3.43	.084
	20	.74	.81	.029	2.55	2.17	.063	4.14	2.99	.077	5.17	3.42	.083
	30	.74	.81	.029	2.56	2.18	.063	4.16	3.00	.078	5.19	3.44	.084
*****													
60	10	.09	.07	.001	1.16	.64	.011	2.66	1.31	.021	3.70	1.72	.026
	20	.09	.04	.001	1.09	.47	.006	2.54	1.01	.013	3.56	1.35	.016
	30	.13	.02	.000	1.10	.34	.003	2.56	.78	.007	3.62	1.09	.010
*****													
30	10	.04	.02	.000	.53	.23	.003	1.69	.67	.008	2.63	1.00	.012
	20	.04	.01	.000	.54	.14	.001	1.75	.47	.004	2.73	.73	.006
	30	.05	.04	.002	.72	.10	.002	2.08	.30	.003	3.13	.49	.003
*****													
0	10	.03	.01	.000	.39	.16	.002	1.42	.52	.006	2.30	.82	.009
	20	.03	.01	.000	.42	.09	.001	1.52	.35	.003	2.46	.57	.004
	30	.03	.03	.001	.69	.06	.001	2.01	.19	.002	3.03	.33	.002
*****													

TABLE 9 – BELKNAP, ORIGIN, ROOT-MEAN-SQUARE ROLL RESPONSE, SINGLE AMPLITUDES

		ROLL SINGLE AMPLITUDES FOR THE DLG - 26 (INTERSECTION OF WATERPLANE AND LCG)											
		ROOT MEAN SQUARE AMPLITUDE											
*HEADING*	SHIP	SIG. WAVE HT. = 4 FT			SIG. WAVE HT. = 10 FT			SIG. WAVE HT. = 16 FT			SIG. WAVE HT. = 20 FT		
ANGLE	SPEED	ANGLE	VEL.	ACCEL.	ANGLE	VEL.	ACCEL.	ANGLE	VEL.	ACCEL.	ANGLE	VEL.	ACCEL.
(DEG)	(KNOTS)	(DEG)	(DEG/SEC)	(DEG/SEC)	(DEG)	(DEG/SEC)	(DEG/SEC)	(DEG)	(DEG/SEC)	(DEG/SEC)	(DEG)	(DEG/SEC)	(DEG/SEC)
180	10	0.00	0.00	0.000	0.00	0.00	0.000	0.00	0.00	0.000	0.00	0.00	0.000
	20	0.00	0.00	0.000	0.00	0.00	0.000	0.00	0.00	0.000	0.00	0.00	0.000
	30	0.00	0.00	0.000	0.00	0.00	0.000	0.00	0.00	0.000	0.00	0.00	0.000
150	10	.05	.06	.091	1.47	1.11	.888	4.44	3.03	2.144	5.99	4.01	2.762
	20	.02	.04	.081	.68	.63	.638	2.71	2.01	1.599	4.25	3.00	2.235
	30	.01	.03	.094	.39	.44	.549	1.67	1.38	1.278	2.98	2.23	1.840
120	10	.22	.26	.312	3.31	2.51	2.034	7.52	5.18	3.741	9.42	6.35	4.462
	20	.14	.19	.277	2.01	1.73	1.641	5.69	4.10	3.183	7.77	5.38	3.981
	30	.09	.15	.262	1.31	1.29	1.428	4.25	3.23	2.737	6.31	4.52	3.535
90	10	.45	.47	.550	4.73	3.28	2.377	8.28	5.46	3.727	9.60	6.24	4.197
	20	.46	.48	.566	4.69	3.25	2.368	8.20	5.42	3.701	9.52	6.19	4.167
	30	.47	.50	.581	4.62	3.21	2.348	8.10	5.34	3.658	9.40	6.11	4.117
60	10	1.21	.85	.603	7.08	4.48	2.866	9.64	5.93	3.712	10.50	6.39	3.966
	20	.65	.30	.136	2.82	1.28	.584	4.14	1.83	.815	4.68	2.04	.899
	30	.45	.11	.074	2.00	.58	.188	3.08	.92	.291	3.56	1.07	.336
30	10	.40	.22	.117	1.34	.68	.350	2.03	.97	.472	2.36	1.09	.522
	20	.16	.05	.031	.60	.15	.050	1.14	.30	.085	1.43	.38	.106
	30	.72	.45	.280	1.45	.76	.473	2.00	.82	.503	2.29	.85	.511
0	10	.00	.00	.000	.00	.00	.000	.00	.00	.000	.00	.00	.000
	20	.00	.00	.000	.00	.00	.000	.00	.00	.000	.00	.00	.000
	30	.00	.00	.000	.00	.00	.000	.00	.00	.000	.00	.00	.000

TABLE 10 - BELKNAP, ORIGIN, ROOT-MEAN-SQUARE PITCH RESPONSE, SINGLE AMPLITUDES

		PITCH SINGLE AMPLITUDES FOR THE DLG - 26 (INTERSECTION OF WATERPLANE AND LCG)														
* HEADING * * ANGLE *	SHIP * SPEED *	ROOT MEAN SQUARE AMPLITUDE														
		SIG. WAVF HT. = 4 FT			SIG. WAVE HT. = 10 FT			SIG. WAVF HT. = 16 FT			SIG. WAVE HT. = 20 FT					
		ANGLE (DEG)	VEL. (DEG/ SEC)	ACCEL. (DEG/ SEC)	ANGLE (DEG)	VEL. (DEG/ SEC)	ACCEL. (DEG/ SEC)	ANGLE (DEG)	VEL. (DEG/ SEC)	ACCEL. (DEG/ SEC)	ANGLE (DEG)	VEL. (DEG/ SEC)	ACCEL. (DEG/ SEC)	ANGLE (DEG)	VEL. (DEG/ SEC)	ACCEL. (DEG/ SEC)
180	10	.03	.04	.060	.57	.51	.469	1.27	1.00	.834	1.66	1.24	.991			
	20	.01	.02	.047	.56	.59	.642	1.32	1.25	1.245	1.74	1.56	1.503			
	30	.01	.02	.042	.46	.54	.673	1.21	1.30	1.457	1.64	1.67	1.809			
150	10	.03	.04	.056	.67	.59	.544	1.34	1.07	.902	1.69	1.28	1.045			
	20	.02	.03	.049	.64	.67	.723	1.36	1.28	1.281	1.74	1.56	1.505			
	30	.01	.02	.043	.53	.62	.761	1.25	1.32	1.475	1.64	1.65	1.774			
120	10	.13	.15	.169	.85	.80	.791	1.32	1.13	1.044	1.53	1.26	1.130			
	20	.09	.11	.146	.76	.79	.860	1.25	1.18	1.197	1.47	1.33	1.312			
	30	.06	.08	.121	.66	.75	.882	1.15	1.17	1.290	1.37	1.34	1.432			
90	10	.08	.09	.118	.14	.15	.180	.15	.17	.191	.16	.17	.194			
	20	.07	.09	.110	.13	.14	.167	.16	.16	.178	.17	.16	.182			
	30	.07	.08	.106	.13	.14	.160	.17	.16	.174	.19	.17	.178			
60	10	.11	.08	.060	.59	.36	.230	.97	.55	.322	1.15	.62	.357			
	20	.08	.04	.017	.50	.22	.101	.82	.35	.153	.99	.41	.176			
	30	.11	.02	.013	.48	.14	.043	.79	.24	.074	.97	.29	.089			
30	10	.04	.02	.010	.41	.19	.087	.90	.39	.169	1.18	.49	.209			
	20	.02	.01	.012	.37	.10	.028	.84	.23	.062	1.13	.30	.082			
	30	.03	.03	.032	.47	.06	.041	1.08	.14	.046	1.44	.20	.052			
0	10	.03	.01	.007	.34	.14	.061	.84	.33	.133	1.15	.44	.172			
	20	.02	.01	.006	.32	.07	.016	.82	.18	.043	1.14	.26	.060			
	30	.03	.03	.028	.47	.05	.043	1.15	.10	.046	1.56	.15	.049			

TABLE 11 BELKNAP, ORIGIN, ROOT-MEAN-SQUARE YAW RESPONSE, SINGLE AMPLITUDES

		YAW SINGLE AMPLITUDES FOR THE DLG - 26 (INTERSECTION OF WATERPLANE AND LCG)											
		ROOT MEAN SQUARE AMPLITUDE											
*HEADING*	*SHIP*	*SIG. WAVE HT. = 4 FT*			*SIG. WAVE HT. = 10 FT*			*SIG. WAVE HT. = 16 FT*			*SIG. WAVE HT. = 20 FT*		
*ANGLE*	*SPEED*	*ANGLE*	*VEL.*	*ACCEL.*	*ANGLE*	*VEL.*	*ACCEL.*	*ANGLE*	*VEL.*	*ACCEL.*	*ANGLE*	*VEL.*	*ACCEL.*
(DEG)	(KNOTS)	(DEG)	(DEG/SEC)	(DEG/SEC)	(DEG)	(DEG/SEC)	(DEG/SEC)	(DEG)	(DEG/SEC)	(DEG/SEC)	(DEG)	(DEG/SEC)	(DEG/SEC)
180	10	0.00	0.00	0.000	0.00	0.00	0.000	0.00	0.00	0.000	0.00	0.00	0.000
	20	0.00	0.00	0.000	0.00	0.00	0.000	0.00	0.00	0.000	0.00	0.00	0.000
	30	0.00	0.00	0.000	0.00	0.00	0.000	0.00	0.00	0.000	0.00	0.00	0.000
150	10	.01	.01	.020	.12	.10	.097	.34	.24	.183	.49	.32	.229
	20	.01	.01	.020	.09	.10	.113	.23	.20	.195	.34	.26	.237
	30	.00	.01	.024	.07	.09	.125	.17	.18	.213	.24	.23	.253
120	10	.05	.06	.074	.31	.28	.269	.63	.47	.388	.81	.56	.440
	20	.04	.05	.078	.24	.26	.300	.48	.41	.413	.63	.50	.462
	30	.03	.05	.079	.20	.24	.316	.37	.37	.428	.50	.44	.474
90	10	.04	.05	.075	.18	.14	.127	.29	.20	.163	.33	.23	.176
	20	.04	.05	.073	.17	.13	.122	.28	.20	.157	.32	.22	.170
	30	.03	.05	.071	.16	.12	.117	.26	.19	.150	.30	.21	.162
60	10	.05	.03	.025	.52	.30	.175	.93	.50	.277	1.13	.59	.317
	20	--	--	--	--	--	--	--	--	--	--	--	--
	30	--	--	--	--	--	--	--	--	--	--	--	--
30	10	.06	.03	.016	.30	.14	.068	.64	.28	.123	.82	.35	.149
	20	--	--	--	--	--	--	--	--	--	--	--	--
	30	--	--	--	--	--	--	--	--	--	--	--	--
0	10	.00	.00	.000	.00	.00	.000	.00	.00	.000	.00	.00	.000
	20	.00	.00	.000	.00	.00	.000	.00	.00	.000	.00	.00	.000
	30	.00	.00	.000	.00	.00	.000	.00	.00	.000	.00	.00	.000

TABLE 12 – BELKNAP, POINT 1, ROOT-MEAN-SQUARE LONGITUDINAL RESPONSE, SINGLE AMPLITUDES

		LONGITUDINAL DIRECTION											
		SINGLE AMPLITUDES FOR THE DLG - 26											
		{POINT 1 : ( 108.71, 0.00, 19.70 ) }											
		ROOT MEAN SQUARE AMPLITUDE											
		SIG. WAVF HT. = 4 FT			SIG. WAVE HT. = 10 FT			SIG. WAVE HT. = 16 FT			SIG. WAVF HT. = 20 FT		
		DISPL.	VEL.	ACCEL.	DISPL.	VEL.	ACCEL.	DISPL.	VEL.	ACCEL.	DISPL.	VEL.	ACCEL.
		(FT)	(FT/SEC)	(G)	(FT)	(FT/SEC)	(G)	(FT)	(FT/SEC)	(G)	(FT)	(FT/SEC)	(G)
HEADING*	SHIP*												
ANGLE*	SPEED*												
(DEG)	(KNOTS)												
180	10	.01	.02	.001	.23	.20	.006	.64	.45	.011	1.01	.64	.014
	20	.01	.01	.001	.23	.25	.009	.55	.52	.016	.80	.67	.020
	30	.00	.01	.001	.20	.25	.010	.51	.55	.020	.70	.71	.024
150	10	.02	.02	.001	.27	.23	.007	.67	.48	.012	1.01	.65	.015
	20	.01	.01	.001	.26	.28	.010	.58	.53	.017	.81	.67	.020
	30	.01	.01	.001	.23	.28	.011	.52	.56	.020	.71	.70	.024
120	10	.06	.07	.002	.34	.32	.010	.62	.48	.013	.85	.58	.015
	20	.04	.06	.002	.31	.34	.012	.54	.50	.016	.71	.58	.018
	30	.03	.04	.002	.28	.33	.013	.48	.50	.018	.62	.58	.020
90	10	.03	.04	.002	.09	.08	.003	.20	.13	.003	.29	.16	.004
	20	.03	.04	.002	.08	.07	.002	.19	.12	.003	.28	.15	.003
	30	.03	.03	.002	.08	.07	.002	.18	.11	.003	.27	.14	.003
60	10	.03	.02	.001	.48	.26	.004	1.20	.57	.009	1.72	.78	.011
	20	--	--	--	--	--	--	--	--	--	--	--	--
	30	--	--	--	--	--	--	--	--	--	--	--	--
30	10	.05	.02	.000	.60	.26	.004	1.84	.74	.009	2.81	1.07	.013
	20	--	--	--	--	--	--	--	--	--	--	--	--
	30	--	--	--	--	--	--	--	--	--	--	--	--
0	10	.77	.05	.000	1.01	.25	.003	2.17	.7	.009	3.26	1.14	.013
	20	--	--	--	--	--	--	--	--	--	--	--	--
	30	--	--	--	--	--	--	--	--	--	--	--	--

TABLE 13 - BELKNAP, POINT 1, ROOT-MEAN-SQUARE LATERAL RESPONSE, SINGLE AMPLITUDES

		LATERAL DIRECTION														
		SINGLE AMPLITUDES FOR TME DLG - 26														
		(POINT 1 : ( 108.71, 0.00, 19.70 )														
HEADING*	SHIP	ROOT MEAN SQUARE AMPLITUDE														
ANGLE	SPEED	SIG. WAVE HT. = 4 FT			SIG. WAVE HT. = 10 FT			SIG. WAVE HT. = 16 FT			SIG. WAVE HT. = 20 FT					
		DISPL.	VEL.	ACCEL.	DISPL.	VEL.	ACCEL.	DISPL.	VEL.	ACCEL.	DISPL.	VEL.	ACCEL.			
(DEG)	(KNOTS)	(FT)	(FT/SEC)	(G)	(FT)	(FT/SEC)	(G)	(FT)	(FT/SEC)	(G)	(FT)	(FT/SEC)	(G)			
180	10	0.00	0.00	0.000	0.00	0.00	0.000	0.00	0.00	0.000	0.00	0.00	0.000			
	20	0.00	0.00	0.000	0.00	0.00	0.000	0.00	0.00	0.000	0.00	0.00	0.000			
	30	0.00	0.00	0.000	0.00	0.00	0.000	0.00	0.00	0.000	0.00	0.00	0.000			
150	10	.02	.03	.002	.61	.50	.013	1.50	1.10	.026	1.95	1.38	.032			
	20	.01	.02	.001	.41	.41	.013	1.20	.99	.027	1.71	1.33	.035			
	30	.01	.02	.002	.30	.35	.013	.92	.86	.028	1.42	1.21	.036			
120	10	.16	.18	.007	1.59	1.32	.036	3.00	2.25	.056	3.71	2.65	.064			
	20	.12	.15	.007	1.23	1.17	.037	2.64	2.13	.059	3.40	2.60	.068			
	30	.09	.13	.007	.97	1.03	.037	2.26	1.97	.060	3.06	2.48	.071			
90	10	.47	.53	.021	2.15	1.72	.047	3.41	2.43	.060	4.18	2.77	.065			
	20	.46	.53	.020	2.14	1.71	.047	3.41	2.43	.060	4.19	2.77	.065			
	30	.46	.52	.020	2.14	1.71	.046	3.42	2.43	.060	4.20	2.77	.065			
60	10	.41	.29	.006	1.94	1.26	.026	3.02	1.74	.033	3.82	2.03	.037			
	20	--	--	--	--	--	--	--	--	--	--	--	--			
	30	--	--	--	--	--	--	--	--	--	--	--	--			
30	10	.08	.03	.001	.64	.29	.004	1.53	.64	.009	2.15	.86	.011			
	20	--	--	--	--	--	--	--	--	--	--	--	--			
	30	--	--	--	--	--	--	--	--	--	--	--	--			
0	10	.00	.00	.000	.00	.00	.000	.00	.00	.000	.00	.00	.000			
	20	.00	.00	.000	.00	.00	.000	.00	.00	.000	.00	.00	.000			
	30	.00	.00	.000	.00	.00	.000	.00	.00	.000	.00	.00	.000			

TABLE 14 – BELKNAP, POINT 1, ROOT-MEAN-SQUARE VERTICAL RESPONSE, SINGLE AMPLITUDES

*HEADING*		VERTICAL DIRECTION														
SHIP		SINGLE AMPLITUDES FOR THE DLG - 26														
ANGLE		POINT 1 : ( 108.71, 0.00, 19.70 )														
SPEED		ROOT MEAN SQUARE AMPLITUDE														
		SIG. WAVE HT. = 4 FT			SIG. WAVE HT. = 10 FT			SIG. WAVE HT. = 16 FT			SIG. WAVE HT. = 20 FT					
		DISPL.	VEL.	ACCEL.	DISPL.	VEL.	ACCEL.	DISPL.	VEL.	ACCEL.	DISPL.	VEL.	ACCEL.			
		(FT)	(FT/SEC)	(G)	(FT)	(FT/SEC)	(G)	(FT)	(FT/SEC)	(G)	(FT)	(FT/SEC)	(G)			
(DEG)	(KNOTS)															
180	10	.08	.11	.005	.72	.67	.022	1.98	1.43	.037	2.98	1.96	.045			
	20	.04	.06	.003	.83	.89	.032	2.16	1.94	.060	3.14	2.58	.074			
	30	.02	.03	.003	1.13	1.34	.051	2.96	3.17	.111	4.09	4.10	.138			
150	10	.08	.11	.005	.84	.73	.022	2.22	1.58	.039	3.26	2.12	.048			
	20	.05	.07	.004	1.04	1.10	.038	2.48	2.21	.067	3.49	2.85	.081			
	30	.03	.05	.003	1.38	1.61	.060	3.25	3.41	.118	4.38	4.30	.143			
120	10	.18	.20	.008	1.52	1.31	.037	3.11	2.25	.056	4.19	2.78	.065			
	20	.19	.24	.010	1.82	1.85	.062	3.43	2.97	.089	4.48	3.55	.100			
	30	.14	.20	.009	2.14	2.36	.084	3.96	3.87	.128	5.03	4.56	.144			
90	10	.71	.80	.029	2.44	2.08	.061	4.01	2.88	.075	5.04	3.31	.081			
	20	.69	.76	.028	2.39	2.03	.059	3.94	2.82	.073	4.95	3.24	.079			
	30	.67	.74	.027	2.37	2.01	.058	3.89	2.79	.072	4.89	3.20	.077			
60	10	.20	.15	.004	1.39	.80	.015	2.93	1.48	.025	3.98	1.89	.030			
	20	.15	.07	.001	1.22	.53	.007	2.66	1.07	.014	3.67	1.41	.017			
	30	.15	.04	.001	1.14	.35	.003	2.53	.77	.007	3.55	1.07	.010			
30	10	.09	.05	.001	.80	.36	.005	2.10	.86	.011	3.09	1.21	.015			
	20	.05	.02	.001	.73	.19	.002	2.03	.54	.005	3.03	.81	.007			
	30	.07	.06	.002	.55	.10	.003	1.74	.27	.003	2.70	.44	.004			
0	10	.07	.03	.000	.65	.27	.004	1.84	.71	.009	2.80	1.02	.012			
	20	.04	.02	.000	.60	.13	.001	1.82	.42	.003	2.79	.65	.005			
	30	.04	.03	.001	.40	.07	.002	1.23	.15	.002	2.05	.26	.002			



TABLE 15 – BELKNAP, POINT 2, ROOT-MEAN-SQUARE LONGITUDINAL RESPONSE, SINGLE AMPLITUDES

		LONGITUDINAL DIRECTION SINGLE AMPLITUDES FOR THE DLG - 26 (POINT 2 : ( 131.67, 0.00, 20.90 )											
		ROOT MEAN SQUARE AMPLITUDE.											
		SIG. WAVE HT. = 4 FT			SIG. WAVE HT. = 10 FT			SIG. WAVE HT. = 16 FT			SIG. WAVE HT. = 20 FT		
HEADING*	SHIP*	DISPL.	VEL.	ACCEL.	DISPL.	VEL.	ACCEL.	DISPL.	VEL.	ACCEL.	DISPL.	VEL.	ACCEL.
ANGLE	SPEED	(FT)	(FT/	(G)	(FT)	(FT/	(G)	(FT)	(FT/	(G)	(FT)	(FT/	(G)
(DEG)	(KNOTS)		SEC)		SEC)			SEC)			SEC)		
180	10	.01	.02	.001	.23	.21	.006	.64	.46	.011	1.00	.64	.014
	20	.01	.01	.001	.24	.26	.009	.57	.53	.017	.81	.68	.020
	30	.00	.01	.001	.21	.26	.010	.52	.57	.021	.72	.73	.025
150	10	.02	.02	.001	.27	.24	.007	.66	.48	.012	1.00	.65	.015
	20	.01	.02	.001	.27	.29	.010	.59	.55	.017	.82	.69	.020
	30	.01	.01	.001	.24	.29	.011	.54	.58	.021	.72	.72	.025
120	10	.06	.07	.003	.35	.33	.011	.62	.49	.014	.84	.58	.015
	20	.05	.06	.003	.32	.35	.012	.54	.51	.017	.71	.59	.018
	30	.03	.05	.002	.29	.34	.013	.49	.51	.018	.63	.59	.020
90	10	.03	.04	.002	.09	.08	.003	.20	.13	.003	.29	.16	.004
	20	.03	.04	.002	.08	.07	.002	.19	.12	.003	.28	.15	.003
	30	.03	.04	.002	.08	.07	.002	.18	.11	.003	.26	.14	.003
60	10	.03	.02	.001	.47	.25	.004	1.18	.56	.009	1.70	.77	.011
	20	--	--	--	--	--	--	--	--	--	--	--	--
	30	--	--	--	--	--	--	--	--	--	--	--	--
30	10	.05	.02	.000	.59	.26	.004	1.82	.73	.009	2.78	1.06	.013
	20	--	--	--	--	--	--	--	--	--	--	--	--
	30	--	--	--	--	--	--	--	--	--	--	--	--
0	10	.77	.05	.000	1.01	.25	.003	2.16	.75	.009	3.23	1.13	.013
	20	--	--	--	--	--	--	--	--	--	--	--	--
	30	--	--	--	--	--	--	--	--	--	--	--	--

TABLE 16 – BELKNAP, POINT 2, ROOT-MEAN-SQUARE LATERAL RESPONSE, SINGLE AMPLITUDES

		LATERAL DIRECTION											
		SINGLE AMPLITUDES FOR THE DLG - 26											
		{POINT 2 : ( 131.67, 0.00, 20.90) }											
		ROOT MEAN SQUARE AMPLITUDE											
		SIG. WAVE HT. = 4 FT			SIG. WAVE HT. = 10 FT			SIG. WAVE HT. = 16 FT			SIG. WAVE HT. = 20 FT		
		DISPL.	VEL.	ACCEL.	DISPL.	VEL.	ACCEL.	DISPL.	VEL.	ACCEL.	DISPL.	VEL.	ACCEL.
		(FT)	(FT/SEC)	(G)	(FT)	(FT/SEC)	(G)	(FT)	(FT/SEC)	(G)	(FT)	(FT/SEC)	(G)
HEADING	SHIP												
ANGLE	SPEED												
(DEG)	(KNOTS)												
	10	0.00	0.00	0.000	0.00	0.00	0.000	0.00	0.00	0.000	0.00	0.00	0.000
	20	0.00	0.00	0.000	0.00	0.00	0.000	0.00	0.00	0.000	0.00	0.00	0.000
	30	0.00	0.00	0.000	0.00	0.00	0.000	0.00	0.00	0.000	0.00	0.00	0.000
180	10	.03	.04	.002	.66	.54	.014	1.57	1.16	.028	2.03	1.45	.034
	20	.02	.03	.002	.45	.45	.015	1.27	1.06	.030	1.79	1.41	.037
	30	.01	.02	.002	.33	.39	.015	.98	.93	.030	1.49	1.28	.039
150	10	.18	.20	.007	1.68	1.42	.040	3.10	2.36	.060	3.81	2.76	.068
	20	.13	.18	.008	1.31	1.26	.041	2.73	2.24	.063	3.49	2.71	.073
	30	.10	.15	.008	1.03	1.12	.041	2.34	2.07	.064	3.14	2.58	.075
120	10	.47	.54	.021	2.16	1.73	.047	3.42	2.44	.061	4.17	2.78	.066
	20	.47	.53	.021	2.15	1.72	.047	3.42	2.44	.060	4.18	2.77	.065
	30	.46	.52	.020	2.15	1.71	.047	3.43	2.44	.060	4.19	2.78	.065
90	10	.44	.31	.007	2.10	1.36	.028	3.25	1.88	.036	4.08	2.18	.040
	20	--	--	--	--	--	--	--	--	--	--	--	--
	30	--	--	--	--	--	--	--	--	--	--	--	--
60	10	.07	.03	.000	.72	.33	.005	1.72	.72	.010	2.39	.96	.012
	20	--	--	--	--	--	--	--	--	--	--	--	--
	30	--	--	--	--	--	--	--	--	--	--	--	--
30	10	.00	.00	.000	.00	.00	.000	.00	.00	.000	.00	.00	.000
	20	.00	.00	.000	.00	.00	.000	.00	.00	.000	.00	.00	.000
	30	.00	.00	.000	.00	.00	.000	.00	.00	.000	.00	.00	.000
0	10	.00	.00	.000	.00	.00	.000	.00	.00	.000	.00	.00	.000
	20	.00	.00	.000	.00	.00	.000	.00	.00	.000	.00	.00	.000
	30	.00	.00	.000	.00	.00	.000	.00	.00	.000	.00	.00	.000

58

TABLE 17 - BELKNAP, POINT 2, ROOT-MEAN-SQUARE VERTICAL RESPONSE, SINGLE AMPLITUDES

		VERTICAL DIRECTION											
		SINGLE AMPLITUDES FOR THE DLG - 26											
		(POINT 2 : ( 131.67, 0.00, 20.90 ) )											
		ROOT MEAN SQUARE AMPLITUDE											
*HEADING*	*SHIP*	*SIG. WAVE HT. = 4 FT			*SIG. WAVE HT. = 10 FT			*SIG. WAVE HT. = 16 FT			*SIG. WAVE HT. = 20 FT		
		*DISPL.*	*VEL.*	*ACCEL.*	*DISPL.*	*VEL.*	*ACCEL.*	*DISPL.*	*VEL.*	*ACCEL.*	*DISPL.*	*VEL.*	*ACCEL.*
(DEG)	(KNOTS)	(FT)	(FT/SEC)	(G)	(FT)	(FT/SEC)	(G)	(FT)	(FT/SEC)	(G)	(FT)	(FT/SEC)	(G)
180	10	.09	.12	.005	.89	.82	.026	2.32	1.71	.044	3.39	2.28	.054
	20	.04	.07	.004	.91	.99	.035	2.35	2.13	.066	3.38	2.80	.081
	30	.02	.04	.003	1.18	1.42	.055	3.04	3.28	.116	4.19	4.23	.143
150	10	.09	.12	.005	1.03	.90	.027	2.55	1.86	.046	3.64	2.43	.056
	20	.05	.08	.004	1.13	1.20	.042	2.65	2.38	.073	3.70	3.04	.087
	30	.03	.05	.004	1.43	1.68	.064	3.33	3.52	.123	4.46	4.41	.147
120	10	.21	.23	.009	1.67	1.45	.042	3.30	2.43	.062	4.39	2.97	.071
	20	.21	.26	.011	1.88	1.92	.065	3.51	3.06	.092	4.56	3.64	.104
	30	.15	.21	.010	2.17	2.41	.087	3.98	3.92	.130	5.05	4.60	.146
90	10	.71	.80	.030	2.42	2.06	.061	3.99	2.86	.074	5.02	3.29	.080
	20	.68	.76	.028	2.36	2.01	.059	3.90	2.79	.072	4.90	3.21	.078
	30	.66	.73	.027	2.33	1.97	.057	3.84	2.74	.071	4.82	3.16	.076
60	10	.24	.18	.004	1.54	.90	.017	3.12	1.61	.027	4.18	2.02	.032
	20	.18	.08	.001	1.33	.58	.008	2.79	1.13	.014	3.81	1.47	.018
	30	.18	.04	.001	1.23	.37	.004	2.64	.80	.008	3.66	1.10	.010
30	10	.10	.05	.001	.93	.42	.006	2.34	.97	.013	3.37	1.33	.017
	20	.06	.02	.001	.84	.22	.002	2.23	.60	.005	3.27	.87	.007
	30	.08	.06	.002	.68	.11	.003	1.95	.29	.003	2.94	.47	.004
0	10	.08	.04	.001	.77	.32	.004	2.09	.81	.010	3.10	1.14	.013
	20	.05	.02	.001	.70	.15	.001	2.03	.47	.003	3.06	.71	.005
	30	.06	.04	.002	.54	.09	.002	1.49	.17	.002	2.32	.29	.003

TABLE 18 - BELKNAP, POINT 3, ROOT-MEAN-SQUARE LONGITUDINAL RESPONSE, SINGLE AMPLITUDES

```

*****
*                                     LONGITUDINAL DIRECTION
*                                     SINGLE AMPLITUDES FOR THE DLG - 26
*                                     (POINT 3 : ( 154.63, 0.00, 20.95) )
*****
*HEADING* SHIP *                                     ROOT MEAN SQUARE AMPLITUDE
*  ANGLE * SPEED *
* * * * * SIG. WAVE HT. = 4 FT ** SIG. WAVE HT. = 10 FT ** SIG. WAVE HT. = 16 FT ** SIG. WAVE HT. = 20 FT *
* * * * * DISPL. * VEL. * ACCEL. ** DISPL. * VEL. * ACCEL. ** DISPL. * VEL. * ACCEL. ** DISPL. * VEL. * ACCEL. *
* * * * * (FT) * (FT/ * (G) ** (FT) * (FT/ * (G) ** (FT) * (FT/ * (G) ** (FT) * (FT/ * (G) ** (FT) * (FT/ * (G) *
* (DEG) * (KNOTS) * (SEC) * ** (SEC) * ** (SEC) * ** (SEC) * ** (SEC) *
*****
* 180 * 10 * .01 * .02 * .001 ** .23 * .21 * .006 ** .64 * .46 * .011 ** 1.00 * .64 * .014 *
* 180 * 20 * .01 * .01 * .001 ** .24 * .26 * .009 ** .57 * .53 * .017 ** .81 * .68 * .020 *
* 180 * 30 * .00 * .01 * .001 ** .21 * .26 * .010 ** .52 * .57 * .021 ** .72 * .73 * .025 *
*****
* 150 * 10 * .02 * .02 * .001 ** .27 * .24 * .007 ** .66 * .48 * .012 ** 1.00 * .65 * .015 *
* 150 * 20 * .01 * .02 * .001 ** .27 * .29 * .010 ** .59 * .55 * .017 ** .82 * .69 * .020 *
* 150 * 30 * .01 * .01 * .001 ** .24 * .29 * .011 ** .54 * .58 * .021 ** .72 * .72 * .025 *
*****
* 120 * 10 * .06 * .07 * .003 ** .35 * .33 * .011 ** .62 * .49 * .014 ** .84 * .58 * .015 *
* 120 * 20 * .05 * .06 * .003 ** .32 * .35 * .012 ** .54 * .51 * .017 ** .71 * .59 * .018 *
* 120 * 30 * .03 * .05 * .002 ** .29 * .34 * .013 ** .49 * .51 * .018 ** .63 * .59 * .020 *
*****
* 90 * 10 * .03 * .04 * .002 ** .09 * .08 * .003 ** .20 * .13 * .003 ** .29 * .16 * .004 *
* 90 * 20 * .03 * .04 * .002 ** .08 * .07 * .002 ** .19 * .12 * .003 ** .28 * .15 * .003 *
* 90 * 30 * .03 * .04 * .002 ** .08 * .07 * .002 ** .18 * .11 * .003 ** .26 * .14 * .003 *
*****
* 60 * 10 * .03 * .02 * .001 ** .47 * .25 * .004 ** 1.18 * .56 * .009 ** 1.70 * .77 * .011 *
* 60 * 20 * -- * -- * -- ** -- * -- * -- ** -- * -- * -- ** -- * -- * -- *
* 60 * 30 * -- * -- * -- ** -- * -- * -- ** -- * -- * -- ** -- * -- * -- *
*****
* 30 * 10 * .05 * .02 * .000 ** .59 * .26 * .004 ** 1.82 * .73 * .009 ** 2.78 * 1.06 * .013 *
* 30 * 20 * -- * -- * -- ** -- * -- * -- ** -- * -- * -- ** -- * -- * -- *
* 30 * 30 * -- * -- * -- ** -- * -- * -- ** -- * -- * -- ** -- * -- * -- *
*****
* 0 * 10 * .77 * .05 * .000 ** 1.01 * .25 * .003 ** 2.16 * .75 * .009 ** 3.23 * 1.13 * .013 *
* 0 * 20 * -- * -- * -- ** -- * -- * -- ** -- * -- * -- ** -- * -- * -- *
* 0 * 30 * -- * -- * -- ** -- * -- * -- ** -- * -- * -- ** -- * -- * -- *
*****

```

09

TABLE 19 – BELKNAP, POINT 3, ROOT-MEAN-SQUARE LATERAL RESPONSE, SINGLE AMPLITUDES

		LATERAL DIRECTION											
		SINGLE AMPLITUDES FOR THE DLG - 26											
		(POINT 3 : ( 154.63, 0.00, 20.95) )											
HEADING	SHIP	ROOT MEAN SQUARE AMPLITUDE											
ANGLE	SPEED	SIG. WAVE HT. = 4 FT			SIG. WAVE HT. = 10 FT			SIG. WAVE HT. = 16 FT			SIG. WAVE HT. = 20 FT		
		DISPL.	VEL.	ACCEL.	DISPL.	VEL.	ACCEL.	DISPL.	VEL.	ACCEL.	DISPL.	VEL.	ACCEL.
(DEG)	(KNOTS)	(FT)	(FT/SEC)	(G)	(FT)	(FT/SEC)	(G)	(FT)	(FT/SEC)	(G)	(FT)	(FT/SEC)	(G)
180	10	0.00	0.00	0.000	0.00	0.00	0.000	0.00	0.00	0.000	0.00	0.00	0.000
	20	0.00	0.00	0.000	0.00	0.00	0.000	0.00	0.00	0.000	0.00	0.00	0.000
	30	0.00	0.00	0.000	0.00	0.00	0.000	0.00	0.00	0.000	0.00	0.00	0.000
150	10	.03	.04	.002	.68	.56	.015	1.58	1.18	.029	2.03	1.47	.035
	20	.02	.03	.002	.48	.48	.016	1.30	1.10	.031	1.80	1.44	.039
	30	.01	.03	.002	.35	.42	.016	1.01	.97	.032	1.51	1.33	.041
120	10	.20	.22	.008	1.72	1.48	.042	3.11	2.40	.062	3.81	2.79	.069
	20	.15	.19	.009	1.36	1.33	.044	2.74	2.29	.066	3.48	2.75	.075
	30	.11	.17	.009	1.08	1.18	.044	2.36	2.13	.068	3.13	2.62	.078
90	10	.47	.53	.021	2.11	1.69	.047	3.34	2.39	.059	4.10	2.72	.064
	20	.46	.52	.021	2.10	1.68	.046	3.35	2.39	.059	4.11	2.72	.064
	30	.45	.52	.020	2.10	1.68	.046	3.36	2.39	.059	4.13	2.72	.064
60	10	.45	.32	.007	2.19	1.41	.029	3.45	1.98	.038	4.33	2.31	.042
	20	--	--	--	--	--	--	--	--	--	--	--	--
	30	--	--	--	--	--	--	--	--	--	--	--	--
30	10	.07	.03	.000	.82	.37	.005	1.94	.82	.011	2.67	1.08	.014
	20	--	--	--	--	--	--	--	--	--	--	--	--
	30	--	--	--	--	--	--	--	--	--	--	--	--
0	10	.00	.00	.000	.00	.00	.000	.00	.00	.000	.00	.00	.000
	20	.00	.00	.000	.00	.00	.000	.00	.00	.000	.00	.00	.000
	30	.00	.00	.000	.00	.00	.000	.00	.00	.000	.00	.00	.000

TABLE 20 – BELKNAP, POINT 3, ROOT-MEAN-SQUARE VERTICAL RESPONSE, SINGLE AMPLITUDES

		VERTICAL DIRECTION											
		SINGLE AMPLITUDES FOR THE DLG - 26											
		(POINT 3 : ( 154.63, 0.00, 20.95) )											
		ROOT MEAN SQUARE AMPLITUDE											
		SIG. WAVE HT. = 4 FT			SIG. WAVE HT. = 10 FT			SIG. WAVE HT. = 16 FT			SIG. WAVE HT. = 20 FT		
		DISPL.	VEL.	ACCEL.	DISPL.	VEL.	ACCEL.	DISPL.	VEL.	ACCEL.	DISPL.	VEL.	ACCEL.
		(FT)	(FT/SEC)	(G)	(FT)	(FT/SEC)	(G)	(FT)	(FT/SEC)	(G)	(FT)	(FT/SEC)	(G)
(DEG)	(KNOTS)												
180	10	.09	.13	.006	1.09	.98	.030	2.72	2.04	.052	3.87	2.67	.064
	20	.05	.08	.004	1.04	1.13	.040	2.63	2.41	.075	3.73	3.14	.092
	30	.02	.04	.004	1.26	1.52	.059	3.20	3.47	.123	4.38	4.45	.152
150	10	.10	.14	.006	1.25	1.10	.032	2.94	2.18	.055	4.09	2.80	.066
	20	.06	.09	.005	1.27	1.35	.047	2.91	2.64	.081	4.02	3.35	.097
	30	.03	.06	.004	1.51	1.79	.068	3.47	3.69	.130	4.63	4.61	.155
120	10	.24	.28	.010	1.86	1.65	.048	3.57	2.68	.069	4.67	3.22	.079
	20	.23	.29	.012	1.98	2.03	.069	3.65	3.21	.098	4.72	3.80	.109
	30	.17	.23	.011	2.23	2.49	.091	4.06	4.02	.135	5.13	4.71	.151
90	10	.71	.80	.030	2.40	2.05	.061	3.96	2.84	.074	4.99	3.27	.080
	20	.67	.75	.028	2.33	1.98	.058	3.86	2.76	.071	4.86	3.17	.077
	30	.65	.72	.026	2.29	1.94	.056	3.78	2.70	.069	4.76	3.11	.075
60	10	.28	.21	.005	1.72	1.02	.019	3.35	1.75	.030	4.42	2.17	.035
	20	.21	.10	.001	1.46	.64	.009	2.96	1.21	.016	3.98	1.55	.019
	30	.22	.05	.001	1.35	.40	.004	2.78	.84	.008	3.80	1.14	.011
30	10	.11	.06	.001	1.07	.49	.007	2.61	1.09	.014	3.70	1.47	.019
	20	.07	.02	.001	.96	.25	.002	2.47	.66	.006	3.56	.95	.008
	30	.09	.07	.003	.84	.13	.003	2.23	.33	.004	3.27	.51	.004
0	10	.09	.04	.001	.89	.38	.005	2.35	.91	.011	3.43	1.28	.015
	20	.06	.02	.001	.81	.17	.001	2.28	.52	.004	3.37	.78	.006
	30	.07	.05	.002	.71	.11	.003	1.82	.20	.003	2.71	.32	.003

TABLE 21 - BELKNAP, POINT 4, ROOT-MEAN-SQUARE LONGITUDINAL RESPONSE, SINGLE AMPLITUDES

		LONGITUDINAL DIRECTION SINGLE AMPLITUDES FOR THE DLG - 26 (POINT 4 : ( 131.67, -10.38, 20.90 ) )											
*HEADING* *ANGLE	*SHIP *SPEED	*ROOT MEAN SQUARE AMPLITUDE*											
		*SIG. WAVE HT. = 4 FT*			*SIG. WAVE HT. = 10 FT*			*SIG. WAVE HT. = 14 FT*			*SIG. WAVE HT. = 20 FT*		
		*DISPL.*	*VEL.*	*ACCEL.*	*DISPL.*	*VEL.*	*ACCEL.*	*DISPL.*	*VEL.*	*ACCEL.*	*DISPL.*	*VEL.*	*ACCEL.*
(DEG)	(KNOTS)	(FT)	(FT/SEC)	(G)	(FT)	(FT/SEC)	(G)	(FT)	(FT/SEC)	(G)	(FT)	(FT/SEC)	(G)
180	10	.01	.02	.001	.23	.21	.006	.64	.46	.011	1.00	.64	.014
	20	.01	.01	.001	.24	.26	.009	.57	.53	.017	.81	.68	.020
	30	.00	.01	.001	.21	.26	.010	.52	.57	.021	.72	.73	.025
150	10	.02	.02	.001	.26	.23	.007	.63	.45	.011	.97	.62	.014
	20	.01	.02	.001	.26	.28	.010	.56	.52	.017	.78	.66	.020
	30	.01	.01	.001	.23	.28	.011	.51	.56	.020	.69	.69	.024
120	10	.06	.06	.002	.30	.29	.009	.56	.43	.012	.79	.53	.014
	20	.04	.06	.002	.29	.32	.011	.49	.45	.015	.65	.53	.016
	30	.03	.04	.002	.26	.31	.012	.44	.46	.017	.57	.53	.018
90	10	.03	.04	.002	.11	.09	.003	.22	.14	.003	.31	.18	.004
	20	.03	.03	.001	.10	.08	.002	.21	.13	.003	.30	.17	.003
	30	.02	.03	.001	.09	.07	.002	.20	.12	.003	.28	.15	.003
60	10	.03	.02	.001	.40	.21	.004	1.08	.51	.008	1.59	.70	.010
	20	--	--	--	--	--	--	--	--	--	--	--	--
	30	--	--	--	--	--	--	--	--	--	--	--	--
30	10	.06	.02	.000	.56	.24	.003	1.76	.70	.009	2.71	1.03	.012
	20	--	--	--	--	--	--	--	--	--	--	--	--
	30	--	--	--	--	--	--	--	--	--	--	--	--
0	10	.77	.05	.000	1.01	.25	.003	2.16	.75	.009	3.23	1.13	.013
	20	--	--	--	--	--	--	--	--	--	--	--	--
	30	--	--	--	--	--	--	--	--	--	--	--	--

TABLE 22 - BELKNAP, POINT 4, ROOT-MEAN-SQUARE LATERAL RESPONSE, SINGLE AMPLITUDES

```

*****
*                                     LATERAL DIRECTION
*                                     SINGLE AMPLITUDES FOR THE DLG - 26
*                                     (POINT 4 : ( 131.67, -10.38, 20.90 ) )
*                                     *****
*HEADING* SHIP
* ANGLE * SPEED)
*                                     ROOT MEAN SQUARE AMPLITUDE
*
* SIG. WAVE HT. = 4 FT ** SIG. WAVE HT. = 10 FT ** SIG. WAVE HT. = 16 FT ** SIG. WAVE HT. = 20 FT
*
* DISPL. * VEL. * ACCEL. ** DISPL. * VEL. * ACCEL. ** DISPL. * VEL. * ACCEL. ** DISPL. * VEL. * ACCEL.
*
* (DEG) * (KNOTS) * (FT) * (FT/ * (G) ** (FT) * (FT/ * (G) ** (FT) * (FT/ * (G) ** (FT) * (FT/ * (G)
*                   * SEC) *                   * SEC) *                   * SEC) *                   * SEC) *
*****
*
* 180 * 10 * 0.00 * 0.00 * 0.000 ** 0.00 * 0.00 * 0.000 ** 0.00 * 0.00 * 0.000 ** 0.00 * 0.00 * 0.000
*     * 20 * 0.00 * 0.00 * 0.000 ** 0.00 * 0.00 * 0.000 ** 0.00 * 0.00 * 0.000 ** 0.00 * 0.00 * 0.000
*     * 30 * 0.00 * 0.00 * 0.000 ** 0.00 * 0.00 * 0.000 ** 0.00 * 0.00 * 0.000 ** 0.00 * 0.00 * 0.000
*
*****
*
* 150 * 10 * .03 * .04 * .002 ** .66 * .54 * .014 ** 1.57 * 1.16 * .028 ** 2.03 * 1.45 * .034
*     * 20 * .02 * .03 * .002 ** .45 * .45 * .015 ** 1.27 * 1.06 * .030 ** 1.79 * 1.41 * .037
*     * 30 * .01 * .02 * .002 ** .33 * .39 * .015 ** .98 * .93 * .030 ** 1.49 * 1.28 * .039
*
*****
*
* 120 * 10 * .18 * .20 * .007 ** 1.68 * 1.42 * .040 ** 3.10 * 2.36 * .060 ** 3.81 * 2.76 * .068
*     * 20 * .13 * .18 * .008 ** 1.31 * 1.26 * .041 ** 2.73 * 2.24 * .063 ** 3.49 * 2.71 * .073
*     * 30 * .10 * .15 * .008 ** 1.03 * 1.12 * .041 ** 2.34 * 2.07 * .064 ** 3.14 * 2.58 * .075
*
*****
*
* 90 * 10 * .47 * .54 * .021 ** 2.16 * 1.73 * .047 ** 3.42 * 2.44 * .061 ** 4.17 * 2.78 * .066
*     * 20 * .47 * .53 * .021 ** 2.15 * 1.72 * .047 ** 3.42 * 2.44 * .060 ** 4.18 * 2.77 * .065
*     * 30 * .46 * .52 * .020 ** 2.15 * 1.71 * .047 ** 3.43 * 2.44 * .060 ** 4.19 * 2.78 * .065
*
*****
*
* 60 * 10 * .44 * .31 * .007 ** 2.10 * 1.36 * .028 ** 3.25 * 1.88 * .036 ** 4.08 * 2.18 * .040
*     * 20 * -- * -- * -- ** -- * -- * -- ** -- * -- * -- ** -- * -- * --
*     * 30 * -- * -- * -- ** -- * -- * -- ** -- * -- * -- ** -- * -- * --
*
*****
*
* 30 * 10 * .07 * .03 * .000 ** .72 * .33 * .005 ** 1.72 * .72 * .010 ** 2.39 * .96 * .012
*     * 20 * -- * -- * -- ** -- * -- * -- ** -- * -- * -- ** -- * -- * --
*     * 30 * -- * -- * -- ** -- * -- * -- ** -- * -- * -- ** -- * -- * --
*
*****
*
* 0 * 10 * .00 * .00 * .000 ** .00 * .00 * .000 ** .00 * .00 * .000 ** .00 * .00 * .000
*     * 20 * .00 * .00 * .000 ** .00 * .00 * .000 ** .00 * .00 * .000 ** .00 * .00 * .000
*     * 30 * .00 * .00 * .000 ** .00 * .00 * .000 ** .00 * .00 * .000 ** .00 * .00 * .000
*
*****

```



TABLE 23 - BELKNAP, POINT 4, ROOT-MEAN-SQUARE VERTICAL RESPONSE, SINGLE AMPLITUDES

		VERTICAL DIRECTION SINGLE AMPLITUDES FOR THE DLG - 26 (POINT 4 : ( 131.67, -10.38, 20.90 ) )											
HEADING ANGLE	SHIP SPEED	ROOT MEAN SQUARE AMPLITUDE											
		SIG. WAVE HT. = 4 FT			SIG. WAVE HT. = 10 FT			SIG. WAVE HT. = 16 FT			SIG. WAVE HT. = 20 FT		
		DISPL.	VEL.	ACCEL.	DISPL.	VEL.	ACCEL.	DISPL.	VEL.	ACCEL.	DISPL.	VEL.	ACCEL.
(DEG)	(KNOTS)	(FT)	(FT/ SEC)	(G)	(FT)	(FT/ SEC)	(G)	(FT)	(FT/ SEC)	(G)	(FT)	(FT/ SEC)	(G)
180	10	.09	.12	.005	.89	.82	.026	2.32	1.71	.044	3.39	2.28	.054
	20	.04	.07	.004	.91	.99	.035	2.35	2.13	.066	3.38	2.80	.081
	30	.02	.04	.003	1.18	1.42	.055	3.04	3.28	.116	4.19	4.23	.143
150	10	.09	.13	.006	1.25	1.06	.031	3.17	2.29	.056	4.40	2.97	.068
	20	.05	.08	.004	1.22	1.28	.044	3.00	2.64	.079	4.26	3.43	.096
	30	.03	.05	.004	1.47	1.74	.066	3.48	3.65	.127	4.75	4.62	.153
120	10	.24	.27	.010	2.15	1.81	.051	4.36	3.17	.078	5.64	3.85	.090
	20	.23	.29	.012	2.11	2.13	.071	4.22	3.55	.104	5.55	4.29	.118
	30	.16	.23	.010	2.30	2.55	.092	4.41	4.23	.139	5.74	5.06	.157
90	10	.77	.87	.032	3.01	2.45	.069	4.98	3.52	.088	6.08	4.02	.095
	20	.74	.83	.031	2.96	2.40	.067	4.89	3.45	.086	5.96	3.94	.093
	30	.73	.81	.029	2.93	2.37	.066	4.83	3.41	.084	5.89	3.89	.092
60	10	.33	.24	.006	2.37	1.42	.027	4.04	2.22	.040	5.05	2.62	.045
	20	.25	.12	.002	1.62	.72	.010	3.05	1.26	.017	4.02	1.59	.020
	30	.21	.05	.001	1.38	.41	.004	2.74	.83	.008	3.72	1.12	.010
30	10	.14	.08	.001	1.05	.49	.007	2.51	1.05	.014	3.54	1.41	.018
	20	.07	.02	.001	.90	.23	.002	2.30	.62	.005	3.34	.89	.007
	30	.17	.11	.003	.79	.19	.004	2.09	.34	.005	3.07	.50	.005
0	10	.08	.04	.001	.77	.32	.004	2.09	.81	.010	3.10	1.14	.013
	20	.05	.02	.001	.70	.15	.001	2.03	.47	.003	3.06	.71	.005
	30	.06	.04	.002	.54	.09	.002	1.49	.17	.002	2.32	.29	.003

TABLE 24 – BELKNAP, POINT 5, ROOT-MEAN-SQUARE LONGITUDINAL RESPONSE, SINGLE AMPLITUDES

		LONGITUDINAL DIRECTION											
		SINGLE AMPLITUDES FOR THE DLG - 26											
		CPOINT 5 : ( 131.67, 0.00, 28.90 )											
HEADING*	SHIP*	ROOT MEAN SQUARE AMPLITUDE											
ANGLE*	SPEED*	SIG. WAVE HT. = 4 FT			SIG. WAVE HT. = 10 FT			SIG. WAVE HT. = 16 FT			SIG. WAVE HT. = 20 FT		
		DISPL.	VEL.	ACCEL.	DISPL.	VEL.	ACCEL.	DISPL.	VEL.	ACCEL.	DISPL.	VEL.	ACCEL.
(DEG)	(KNOTS)	(FT)	(FT/SEC)	(G)	(FT)	(FT/SEC)	(G)	(FT)	(FT/SEC)	(G)	(FT)	(FT/SEC)	(G)
180	10	.02	.02	.001	.28	.25	.008	.66	.50	.013	.97	.66	.015
	20	.01	.02	.001	.30	.33	.011	.67	.65	.021	.89	.81	.025
	30	.00	.01	.001	.27	.33	.013	.65	.72	.026	.85	.90	.032
150	10	.02	.03	.001	.32	.30	.009	.68	.53	.014	.97	.67	.016
	20	.01	.02	.001	.35	.37	.013	.69	.67	.022	.89	.81	.025
	30	.01	.01	.001	.31	.37	.015	.66	.73	.026	.85	.89	.031
120	10	.08	.09	.003	.42	.41	.013	.65	.56	.017	.83	.64	.018
	20	.06	.07	.003	.40	.44	.016	.62	.61	.021	.76	.69	.022
	30	.04	.06	.003	.36	.43	.017	.58	.63	.023	.70	.71	.025
90	10	.04	.06	.002	.10	.09	.003	.20	.14	.004	.29	.17	.004
	20	.04	.05	.002	.09	.08	.003	.18	.12	.003	.27	.15	.004
	30	.03	.05	.002	.08	.07	.003	.17	.11	.003	.25	.14	.003
60	10	.03	.02	.001	.40	.21	.004	1.07	.51	.008	1.57	.70	.010
	20	--	--	--	--	--	--	--	--	--	--	--	--
	30	--	--	--	--	--	--	--	--	--	--	--	--
30	10	.05	.02	.000	.54	.24	.003	1.71	.68	.009	2.63	1.00	.012
	20	--	--	--	--	--	--	--	--	--	--	--	--
	30	--	--	--	--	--	--	--	--	--	--	--	--
0	10	.77	.05	.000	.98	.23	.003	2.06	.71	.008	3.09	1.07	.012
	20	--	--	--	--	--	--	--	--	--	--	--	--
	30	--	--	--	--	--	--	--	--	--	--	--	--

TABLE 25 - BELKNAP, POINT 5, ROOT-MEAN-SQUARE LATERAL RESPONSE, SINGLE AMPLITUDES

		LATERAL DIRECTION														
		SINGLE AMPLITUDES FOR THE DLG - 26														
		{ POINT 5 : ( 131.67, 0.00, 28.90 ) }														
		ROOT MEAN SQUARE AMPLITUDE														
* HEADING * * ANGLE *	* SHIP * * SPEED *	* SIG. WAVE HT. = 4 FT *			* SIG. WAVE HT. = 10 FT *			* SIG. WAVE HT. = 16 FT *			* SIG. WAVE HT. = 20 FT *					
		* DISPL. *	* VEL. *	* ACCEL. *	* DISPL. *	* VEL. *	* ACCEL. *	* DISPL. *	* VEL. *	* ACCEL. *	* DISPL. *	* VEL. *	* ACCEL. *			
		(FT)	(FT/SEC)	(G)	(FT)	(FT/SEC)	(G)	(FT)	(FT/SEC)	(G)	(FT)	(FT/SEC)	(G)			
(DEG)	(KNOTS)															
180	10	0.00	0.00	0.000	0.00	0.00	0.000	0.00	0.00	0.000	0.00	0.00	0.000			
	20	0.00	0.00	0.000	0.00	0.00	0.000	0.00	0.00	0.000	0.00	0.00	0.000			
	30	0.00	0.00	0.000	0.00	0.00	0.000	0.00	0.00	0.000	0.00	0.00	0.000			
150	10	.03	.05	.002	.85	.68	.018	2.09	1.53	.036	2.69	1.91	.044			
	20	.02	.03	.002	.54	.53	.017	1.61	1.31	.036	2.29	1.77	.046			
	30	.01	.03	.002	.38	.44	.017	1.20	1.11	.035	1.86	1.57	.046			
120	10	.21	.24	.009	2.09	1.74	.048	3.93	2.96	.074	4.74	3.46	.084			
	20	.15	.20	.009	1.57	1.49	.048	3.39	2.74	.076	4.32	3.33	.088			
	30	.11	.17	.009	1.21	1.29	.047	2.86	2.47	.075	3.86	3.12	.089			
90	10	.53	.60	.023	2.67	2.09	.056	4.11	2.97	.073	4.81	3.31	.078			
	20	.53	.59	.023	2.65	2.08	.055	4.09	2.95	.072	4.79	3.30	.078			
	30	.52	.59	.023	2.64	2.07	.055	4.08	2.94	.072	4.78	3.29	.078			
60	10	.60	.42	.009	2.82	1.85	.038	3.85	2.38	.047	4.50	2.62	.051			
	20	--	--	--	--	--	--	--	--	--	--	--	--			
	30	--	--	--	--	--	--	--	--	--	--	--	--			
30	10	.11	.05	.001	.70	.33	.005	1.57	.67	.06	2.19	.88	.011			
	20	--	--	--	--	--	--	--	--	--	--	--	--			
	30	--	--	--	--	--	--	--	--	--	--	--	--			
0	10	.00	.00	.000	.00	.00	.000	.00	.00	.000	.00	.00	.000			
	20	.00	.00	.000	.00	.00	.000	.00	.00	.000	.00	.00	.000			
	30	.00	.00	.000	.00	.00	.000	.00	.00	.000	.00	.00	.000			

TABLE 26 – BELKNAP, POINT 5, ROOT-MEAN-SQUARE VERTICAL RESPONSE, SINGLE AMPLITUDES

```

*****
*                                     VERTICAL DIRECTION
*                                     SINGLE AMPLITUDES FOR THE DLG - 26
*                                     (POINT 5 : ( 131.67, 0.00, 28.90) )
*****
*HEADING* SHIP *
* ANGLE * SPEED *
* SIG. WAVE HT. = 4 FT ** SIG. WAVE HT. = 10 FT ** SIG. WAVE HT. = 16 FT ** SIG. WAVE HT. = 20 FT *
* DISPL. * VEL. * ACCEL. ** DISPL. * VEL. * ACCEL. ** DISPL. * VEL. * ACCEL. ** DISPL. * VEL. * ACCEL. *
* (DEG) * (KNOTS) * (FT) * (FT/ * (G) ** (FT) * (FT/ * (G) ** (FT) * (FT/ * (G) ** (FT) * (FT/ * (G) **
* * * (SEC) * ** * (SEC) * ** * (SEC) * ** * (SEC) * ** *
*****
* 180 * 10 * .09 * .12 * .005 ** .89 * .82 * .026 ** 2.32 * 1.71 * .044 ** 3.39 * 2.28 * .054 *
* 20 * .04 * .07 * .004 ** .91 * .99 * .035 ** 2.35 * 2.13 * .066 ** 3.38 * 2.80 * .081 *
* 30 * .02 * .04 * .003 ** 1.18 * 1.42 * .055 ** 3.04 * 3.28 * .116 ** 4.19 * 4.23 * .143 *
*****
* 150 * 10 * .09 * .12 * .005 ** 1.03 * .90 * .027 ** 2.55 * 1.86 * .046 ** 3.64 * 2.43 * .056 *
* 20 * .05 * .08 * .004 ** 1.13 * 1.20 * .042 ** 2.65 * 2.38 * .073 ** 3.70 * 3.04 * .087 *
* 30 * .03 * .05 * .004 ** 1.43 * 1.68 * .064 ** 3.33 * 3.52 * .123 ** 4.46 * 4.41 * .147 *
*****
* 120 * 10 * .21 * .23 * .009 ** 1.67 * 1.45 * .042 ** 3.30 * 2.43 * .062 ** 4.39 * 2.97 * .071 *
* 20 * .21 * .26 * .011 ** 1.88 * 1.92 * .065 ** 3.51 * 3.06 * .092 ** 4.56 * 3.64 * .104 *
* 30 * .15 * .21 * .010 ** 2.17 * 2.41 * .087 ** 3.98 * 3.92 * .120 ** 5.05 * 4.60 * .146 *
*****
* 90 * 10 * .71 * .80 * .030 ** 2.42 * 2.06 * .061 ** 3.99 * 2.86 * .074 ** 5.02 * 3.29 * .080 *
* 20 * .68 * .76 * .028 ** 2.36 * 2.01 * .059 ** 3.90 * 2.79 * .072 ** 4.90 * 3.21 * .078 *
* 30 * .66 * .73 * .027 ** 2.33 * 1.97 * .057 ** 3.84 * 2.74 * .071 ** 4.82 * 3.16 * .076 *
*****
* 60 * 10 * .24 * .18 * .004 ** 1.54 * .90 * .017 ** 3.12 * 1.61 * .027 ** 4.18 * 2.02 * .032 *
* 20 * .18 * .08 * .001 ** 1.33 * .58 * .008 ** 2.79 * 1.13 * .014 ** 3.81 * 1.47 * .018 *
* 30 * .18 * .04 * .001 ** 1.23 * .37 * .004 ** 2.64 * .80 * .008 ** 3.66 * 1.10 * .010 *
*****
* 30 * 10 * .10 * .05 * .001 ** .93 * .42 * .006 ** 2.34 * .97 * .013 ** 3.37 * 1.33 * .017 *
* 20 * .06 * .02 * .001 ** .84 * .22 * .002 ** 2.23 * .60 * .005 ** 3.27 * .87 * .007 *
* 30 * .08 * .06 * .002 ** .68 * .11 * .003 ** 1.95 * .29 * .003 ** 2.94 * .47 * .004 *
*****
* 0 * 10 * .08 * .04 * .001 ** .77 * .32 * .004 ** 2.09 * .81 * .010 ** 3.10 * 1.14 * .013 *
* 20 * .05 * .02 * .001 ** .70 * .15 * .001 ** 2.03 * .47 * .003 ** 3.06 * .71 * .005 *
* 30 * .06 * .04 * .002 ** .54 * .09 * .002 ** 1.49 * .17 * .002 ** 2.32 * .29 * .003 *
*****

```

TABLE 27 - GARCIA, ORIGIN, ROOT-MEAN-SQUARE SURGE RESPONSE, SINGLE AMPLITUDES

		SURGE SINGLE AMPLITUDES FOR THE DE - 1040 (INTERSECTION OF WATERPLANE AND LCG)											
*HEADING* *ANGLE	*SHIP *SPEED	*ROOT MEAN SQUARE AMPLITUDE*											
		*SIG. WAVE HT. = 4 FT*			*SIG. WAVE HT. = 10 FT*			*SIG. WAVE HT. = 16 FT*			*SIG. WAVE HT. = 20 FT*		
		*DISPL.*	*VEL.*	*ACCEL.*	*DISPL.*	*VEL.*	*ACCEL.*	*DISPL.*	*VEL.*	*ACCEL.*	*DISPL.*	*VEL.*	*ACCEL.*
(DEG)	(KNOTS)	(FT)	(FT/SEC)	(G)	(FT)	(FT/SEC)	(G)	(FT)	(FT/SEC)	(G)	(FT)	(FT/SEC)	(G)
	10	.01	.02	.001	.36	.30	.008	1.04	.73	.017	1.56	1.01	.022
180	20	.01	.01	.001	.23	.23	.008	.70	.59	.017	1.08	.83	.022
	30	.00	.01	.001	.15	.18	.007	.50	.49	.016	.79	.70	.021
	10	.02	.02	.001	.39	.33	.009	1.04	.73	.017	1.52	.98	.022
150	20	.01	.01	.001	.26	.26	.009	.72	.60	.017	1.09	.82	.021
	30	.01	.01	.001	.18	.21	.008	.53	.51	.016	.81	.70	.021
	10	.05	.06	.002	.40	.34	.010	.86	.61	.015	1.19	.77	.017
120	20	.03	.05	.002	.30	.29	.010	.67	.53	.015	.94	.67	.017
	30	.02	.04	.002	.23	.25	.009	.54	.47	.014	.77	.60	.017
	10	.03	.04	.001	.17	.13	.003	.39	.23	.005	.57	.30	.006
90	20	.03	.04	.001	.17	.13	.003	.39	.23	.005	.57	.30	.006
	30	.03	.04	.001	.17	.13	.003	.39	.23	.005	.57	.31	.006
	10	.11	.08	.002	.87	.50	.009	1.80	.92	.015	2.43	1.16	.018
60	20	--	--	--	--	--	--	--	--	--	--	--	--
	30	--	--	--	--	--	--	--	--	--	--	--	--
	10	.45	.08	.001	1.25	.53	.008	2.87	1.19	.016	4.00	1.59	.020
30	20	--	--	--	--	--	--	--	--	--	--	--	--
	30	--	--	--	--	--	--	--	--	--	--	--	--
	10	.98	.10	.001	1.61	.52	.007	3.33	1.24	.015	4.63	1.70	.020
0	20	--	--	--	--	--	--	--	--	--	--	--	--
	30	--	--	--	--	--	--	--	--	--	--	--	--

TABLE 28 – GARCIA, ORIGIN, ROOT-MEAN-SQUARE SWAY RESPONSE, SINGLE AMPLITUDES

HEADING		SWAY SINGLE AMPLITUDES FOR THE DE - 1040 (INTERSECTION OF WATERPLANE AND LCG)													
SHIP		ROOT MEAN SQUARE AMPLITUDE													
ANGLE		SIG. WAVE HT. = 4 FT			SIG. WAVE HT. = 10 FT			SIG. WAVE HT. = 16 FT			SIG. WAVE HT. = 20 FT				
		DISPL.	VEL.	ACCEL.	DISPL.	VEL.	ACCEL.	DISPL.	VEL.	ACCEL.	DISPL.	VEL.	ACCEL.		
(DEG)	(KNOTS)	(FT)	(FT/SEC)	(G)	(FT)	(FT/SEC)	(G)	(FT)	(FT/SEC)	(G)	(FT)	(FT/SEC)	(G)		
180	10	0.00	0.00	0.000	0.00	0.00	0.000	0.00	0.00	0.000	0.00	0.00	0.000		
	20	0.00	0.00	0.000	0.00	0.00	0.000	0.00	0.00	0.000	0.00	0.00	0.000		
	30	0.00	0.00	0.000	0.00	0.00	0.000	0.00	0.00	0.000	0.00	0.00	0.000		
150	10	.02	.03	.002	.22	.18	.005	.78	.50	.011	1.23	.74	.015		
	20	.01	.02	.002	.18	.18	.006	.58	.45	.012	.95	.67	.016		
	30	.01	.02	.002	.15	.18	.007	.46	.43	.014	.74	.61	.018		
120	10	.07	.09	.004	.78	.62	.017	2.00	1.31	.029	2.87	1.74	.036		
	20	.06	.09	.004	.65	.62	.020	1.68	1.25	.033	2.46	1.66	.040		
	30	.05	.09	.005	.56	.61	.023	1.41	1.18	.036	2.10	1.57	.043		
90	10	.43	.50	.020	1.87	1.46	.041	3.53	2.31	.054	4.60	2.77	.061		
	20	.42	.49	.019	1.89	1.48	.041	3.56	2.33	.054	4.62	2.80	.061		
	30	.42	.49	.019	1.92	1.49	.041	3.58	2.35	.055	4.63	2.81	.061		
60	10	.23	.17	.004	1.57	.93	.018	3.05	1.59	.027	4.04	1.97	.032		
	20	--	--	--	--	--	--	--	--	--	--	--	--		
	30	--	--	--	--	--	--	--	--	--	--	--	--		
30	10	.92	.08	.001	1.11	.28	.004	1.72	.60	.008	2.27	.82	.010		
	20	--	--	--	--	--	--	--	--	--	--	--	--		
	30	--	--	--	--	--	--	--	--	--	--	--	--		
0	10	.00	.00	.000	.00	.00	.000	.00	.00	.000	.00	.00	.000		
	20	.00	.00	.000	.00	.00	.000	.00	.00	.000	.00	.00	.000		
	30	.00	.00	.000	.00	.00	.000	.00	.00	.000	.00	.00	.000		

TABLE 29 - GARCIA, ORIGIN, ROOT-MEAN-SQUARE HEAVE RESPONSE, SINGLE AMPLITUDES

		HEAVE SINGLE AMPLITUDES FOR THE DE - 1040 (INTERSECTION OF WATERPLANE AND LCG)											
*HEADING*	SHIP *ANGLE*	ROOT MEAN SQUARE AMPLITUDE											
		* SIG. WAVE HT. = 4 FT			* SIG. WAVE HT. = 10 FT			* SIG. WAVE HT. = 16 FT			* SIG. WAVE HT. = 20 FT		
		* DISPL.	* VEL.	* ACCEL.	* DISPL.	* VEL.	* ACCEL.	* DISPL.	* VEL.	* ACCEL.	* DISPL.	* VEL.	* ACCEL.
		(FT)	(FT/ SEC)	(G)	(FT)	(FT/ SEC)	(G)	(FT)	(FT/ SEC)	(G)	(FT)	(FT/ SEC)	(G)
(DEG)	(KNOTS)												
	10	.12	.16	.007	1.36	1.31	.041	2.87	2.33	.065	3.88	2.88	.075
180	20	.07	.10	.005	1.85	2.11	.078	3.84	3.88	.131	5.00	4.71	.152
	30	.04	.07	.004	1.88	2.38	.097	4.34	4.94	.185	5.73	6.14	.222
	10	.16	.20	.008	1.59	1.53	.048	3.14	2.56	.072	4.16	3.10	.082
150	20	.11	.16	.008	2.08	2.35	.086	4.03	4.02	.135	5.17	4.80	.154
	30	.06	.11	.006	2.13	2.66	.107	4.52	5.04	.187	5.84	6.12	.218
	10	.46	.56	.021	2.27	2.20	.071	3.87	3.17	.092	4.89	3.67	.100
120	20	.38	.51	.022	2.63	2.85	.102	4.42	4.16	.136	5.48	4.77	.149
	30	.29	.42	.020	2.73	3.20	.123	4.76	4.90	.173	5.91	5.65	.191
	10	.83	.94	.035	2.58	2.26	.068	4.15	3.05	.082	5.16	3.47	.088
90	20	.83	.95	.035	2.61	2.28	.069	4.18	3.08	.083	5.20	3.50	.088
	30	.85	.97	.036	2.65	2.32	.070	4.26	3.14	.084	5.29	3.56	.090
	10	.21	.15	.003	1.52	.89	.017	3.07	1.58	.027	4.14	1.99	.032
60	20	.17	.08	.001	1.42	.62	.009	3.04	1.23	.016	4.19	1.61	.020
	30	.48	.09	.001	2.06	.59	.006	3.85	1.16	.011	5.08	1.52	.014
	10	.06	.03	.001	.87	.39	.006	2.31	.95	.012	3.39	1.33	.017
30	20	.10	.02	.001	1.10	.29	.002	2.75	.74	.006	3.93	1.05	.009
	30	.16	.06	.002	3.25	.23	.003	6.13	.63	.004	7.71	.91	.005
	10	.04	.02	.000	.72	.30	.004	2.11	.81	.010	3.18	1.17	.014
0	20	.09	.02	.001	.93	.19	.001	2.50	.57	.004	3.66	.84	.006
	30	.09	.09	.004	2.97	.19	.005	6.71	.47	.005	8.74	.72	.006

TABLE 30 – GARCIA, ORIGIN, ROOT-MEAN-SQUARE ROLL RESPONSE, SINGLE AMPLITUDES

		ROLL SINGLE AMPLITUDES FOR THE DE - 1040 (INTERSECTION OF WATERPLANE AND LCG)											
HEADING* ANGLE	SHIP SPEED	ROOT MEAN SQUARE AMPLITUDE											
		SIG. WAVE HT. = 4 FT			SIG. WAVE HT. = 10 FT			SIG. WAVE HT. = 16 FT			SIG. WAVE HT. = 20 FT		
(DEG)	(KNOTS)	ANGLE (DEG)	VEL. (DEG/ SEC)	ACCEL. (DEG/ SEC/ SEC)	ANGLE (DEG)	VEL. (DEG/ SEC)	ACCEL. (DEG/ SEC/ SEC)	ANGLE (DEG)	VEL. (DEG/ SEC)	ACCEL. (DEG/ SEC/ SEC)	ANGLE (DEG)	VEL. (DEG/ SEC)	ACCEL. (DEG/ SEC/ SEC)
180	10	0.00	0.00	0.000	0.00	0.00	0.000	0.00	0.00	0.000	0.00	0.00	0.000
	20	0.00	0.00	0.000	0.00	0.00	0.000	0.00	0.00	0.000	0.00	0.00	0.000
	30	0.00	0.00	0.000	0.00	0.00	0.000	0.00	0.00	0.000	0.00	0.00	0.000
150	10	.06	.08	.114	1.18	.95	.819	2.75	2.05	1.598	3.44	2.52	1.921
	20	.02	.03	.070	.37	.37	.405	1.21	.97	.844	1.73	1.33	1.090
	30	.01	.01	.038	.11	.13	.175	.37	.33	.339	.60	.49	.447
120	10	.22	.28	.358	2.32	1.88	1.631	4.34	3.26	2.585	5.13	3.79	2.936
	20	.09	.14	.218	.96	.87	.889	2.23	1.75	1.491	2.83	2.15	1.757
	30	.03	.05	.103	.31	.32	.385	.85	.70	.647	1.16	.90	.784
90	10	.38	.41	.490	2.83	2.12	1.676	4.28	3.08	2.304	4.78	3.39	2.504
	20	.26	.28	.340	1.82	1.37	1.093	2.76	1.98	1.493	3.09	2.19	1.621
	30	.13	.14	.173	.87	.66	.527	1.32	.95	.717	1.48	1.05	.778
60	10	1.30	.97	.731	4.35	2.97	2.058	5.37	3.58	2.432	5.70	3.76	2.538
	20	.33	.15	.069	1.16	.53	.246	1.58	.71	.322	1.75	.78	.349
	30	.27	.04	.013	.62	.15	.044	.81	.22	.064	.89	.24	.073
30	10	.28	.15	.080	.80	.41	.211	1.16	.56	.277	1.32	.62	.303
	20	.28	.16	.116	.53	.20	.134	.73	.24	.140	.84	.26	.143
	30	.08	.00	.000	1.98	.03	.001	2.88	.04	.001	3.14	.05	.001
0	10	.00	.00	.000	.00	.00	.000	.00	.00	.000	.00	.00	.000
	20	.00	.00	.000	.00	.00	.000	.00	.00	.000	.00	.00	.000
	30	.00	.00	.000	.00	.00	.000	.00	.00	.000	.00	.00	.000



TABLE 31 - GARCIA, ORIGIN, ROOT-MEAN-SQUARE PITCH RESPONSE, SINGLE AMPLITUDES

		PITCH SINGLE AMPLITUDES FOR THE DE - 1040 (INTERSECTION OF WATERPLANE AND LCG)											
* HEADING * * ANGLE *	SHIP SPEED	ROOT MEAN SQUARE AMPLITUDE											
		SIG. WAVE HT. = 4 FT			SIG. WAVE HT. = 10 FT			SIG. WAVE HT. = 16 FT			SIG. WAVE HT. = 20 FT		
(DEG)	(KNOTS)	ANGLE (DEG)	VEL. (DEG/ SEC)	ACCEL. (DEG/ SEC/ SEC)	ANGLE (DEG)	VEL. (DEG/ SEC)	ACCEL. (DEG/ SEC/ SEC)	ANGLE (DEG)	VEL. (DEG/ SEC)	ACCEL. (DEG/ SEC/ SEC)	ANGLE (DEG)	VEL. (DEG/ SEC)	ACCEL. (DEG/ SEC/ SEC)
* 180 *	* 10 *	* .08 *	* .10 *	* .148 *	* .97 *	* .95 *	* .973 *	* 1.77 *	* 1.55 *	* 1.460 *	* 2.18 *	* 1.81 *	* 1.643 *
* 180 *	* 20 *	* .04 *	* .07 *	* .126 *	* .83 *	* .96 *	* 1.174 *	* 1.65 *	* 1.71 *	* 1.908 *	* 2.06 *	* 2.03 *	* 2.189 *
* 180 *	* 30 *	* .02 *	* .04 *	* .112 *	* .63 *	* .83 *	* 1.163 *	* 1.38 *	* 1.62 *	* 2.043 *	* 1.78 *	* 1.98 *	* 2.400 *
* 150 *	* 10 *	* .11 *	* .14 *	* .174 *	* 1.04 *	* 1.02 *	* 1.057 *	* 1.77 *	* 1.57 *	* 1.499 *	* 2.13 *	* 1.79 *	* 1.657 *
* 150 *	* 20 *	* .06 *	* .09 *	* .149 *	* .88 *	* 1.01 *	* 1.221 *	* 1.62 *	* 1.67 *	* 1.859 *	* 1.98 *	* 1.94 *	* 2.092 *
* 150 *	* 30 *	* .03 *	* .06 *	* .131 *	* .68 *	* .88 *	* 1.210 *	* 1.37 *	* 1.58 *	* 1.967 *	* 1.72 *	* 1.88 *	* 2.259 *
* 120 *	* 10 *	* .24 *	* .29 *	* .373 *	* 1.03 *	* 1.05 *	* 1.135 *	* 1.49 *	* 1.37 *	* 1.395 *	* 1.69 *	* 1.50 *	* 1.478 *
* 120 *	* 20 *	* .15 *	* .21 *	* .308 *	* .86 *	* .96 *	* 1.146 *	* 1.32 *	* 1.33 *	* 1.475 *	* 1.53 *	* 1.47 *	* 1.583 *
* 120 *	* 30 *	* .10 *	* .16 *	* .268 *	* .70 *	* .85 *	* 1.117 *	* 1.14 *	* 1.24 *	* 1.493 *	* 1.34 *	* 1.39 *	* 1.620 *
* 90 *	* 10 *	* .13 *	* .17 *	* .231 *	* .21 *	* .25 *	* .316 *	* .24 *	* .27 *	* .331 *	* .25 *	* .27 *	* .336 *
* 90 *	* 20 *	* .13 *	* .17 *	* .230 *	* .24 *	* .26 *	* .322 *	* .30 *	* .29 *	* .343 *	* .33 *	* .31 *	* .349 *
* 90 *	* 30 *	* .13 *	* .17 *	* .234 *	* .27 *	* .28 *	* .333 *	* .36 *	* .32 *	* .360 *	* .41 *	* .35 *	* .369 *
* 60 *	* 10 *	* .20 *	* .15 *	* .113 *	* .77 *	* .50 *	* .333 *	* 1.12 *	* .67 *	* .425 *	* 1.30 *	* .75 *	* .458 *
* 60 *	* 20 *	* .14 *	* .07 *	* .032 *	* .60 *	* .27 *	* .125 *	* .94 *	* .41 *	* .179 *	* 1.14 *	* .48 *	* .203 *
* 60 *	* 30 *	* .39 *	* .07 *	* .022 *	* 1.16 *	* .30 *	* .088 *	* 1.69 *	* .48 *	* .142 *	* 2.00 *	* .57 *	* .172 *
* 30 *	* 10 *	* .07 *	* .04 *	* .020 *	* .64 *	* .30 *	* .146 *	* 1.20 *	* .54 *	* .244 *	* 1.52 *	* .65 *	* .288 *
* 30 *	* 20 *	* .08 *	* .02 *	* .019 *	* .73 *	* .18 *	* .050 *	* 1.43 *	* .37 *	* .100 *	* 1.82 *	* .48 *	* .129 *
* 30 *	* 30 *	* .11 *	* .04 *	* .053 *	* 1.85 *	* .16 *	* .066 *	* 3.67 *	* .40 *	* .085 *	* 4.59 *	* .55 *	* .103 *
* 0 *	* 10 *	* .06 *	* .03 *	* .012 *	* .58 *	* .25 *	* .110 *	* 1.21 *	* .49 *	* .204 *	* 1.57 *	* .62 *	* .250 *
* 0 *	* 20 *	* .07 *	* .02 *	* .018 *	* .67 *	* .13 *	* .033 *	* 1.42 *	* .31 *	* .071 *	* 1.86 *	* .41 *	* .095 *
* 0 *	* 30 *	* .07 *	* .05 *	* .067 *	* 1.48 *	* .14 *	* .092 *	* 3.59 *	* .31 *	* .101 *	* 4.81 *	* .45 *	* .109 *

TABLE 32 - GARCIA, ORIGIN, ROOT-MEAN-SQUARE YAW RESPONSE, SINGLE AMPLITUDES

		YAW SINGLE AMPLITUDES FOR THE DE - 1040 (INTERSECTION OF WATERPLANE AND LCG)											
		ROOT MEAN SQUARE AMPLITUDE											
* HEADING * * ANGLE *	* SHIP * * SPEED *	* SIG. WAVE HT. = 4 FT *			* SIG. WAVE HT. = 10 FT *			* SIG. WAVE HT. = 16 FT *			* SIG. WAVE HT. = 20 FT *		
* (DEG) *	* (KNOTS) *	* ANGLE * * (DEG) *	* VEL. * * (DEG/ * SEC) *	* ACCEL. * * (DEG/ * SEC) *	* ANGLE * * (DEG) *	* VEL. * * (DEG/ * SEC) *	* ACCEL. * * (DEG/ * SEC) *	* ANGLE * * (DEG) *	* VEL. * * (DEG/ * SEC) *	* ACCEL. * * (DEG/ * SEC) *	* ANGLE * * (DEG) *	* VEL. * * (DEG/ * SEC) *	* ACCEL. * * (DEG/ * SEC) *
* 180 *	* 10 *	* 0.00 *	* 0.00 *	* 0.000 *	* 0.00 *	* 0.00 *	* 0.000 *	* 0.00 *	* 0.00 *	* 0.000 *	* 0.00 *	* 0.00 *	* 0.000 *
* 180 *	* 20 *	* 0.00 *	* 0.00 *	* 0.000 *	* 0.00 *	* 0.00 *	* 0.000 *	* 0.00 *	* 0.00 *	* 0.000 *	* 0.00 *	* 0.00 *	* 0.000 *
* 180 *	* 30 *	* 0.00 *	* 0.00 *	* 0.000 *	* 0.00 *	* 0.00 *	* 0.000 *	* 0.00 *	* 0.00 *	* 0.000 *	* 0.00 *	* 0.00 *	* 0.000 *
* 150 *	* 10 *	* .02 *	* .03 *	* .049 *	* .22 *	* .20 *	* .198 *	* .54 *	* .40 *	* .328 *	* .71 *	* .50 *	* .391 *
* 150 *	* 20 *	* .02 *	* .03 *	* .053 *	* .14 *	* .17 *	* .230 *	* .34 *	* .31 *	* .338 *	* .48 *	* .40 *	* .392 *
* 150 *	* 30 *	* .01 *	* .02 *	* .059 *	* .11 *	* .16 *	* .247 *	* .23 *	* .26 *	* .354 *	* .32 *	* .32 *	* .401 *
* 120 *	* 10 *	* .10 *	* .13 *	* .180 *	* .47 *	* .43 *	* .457 *	* .88 *	* .69 *	* .614 *	* 1.08 *	* .80 *	* .678 *
* 120 *	* 20 *	* .07 *	* .12 *	* .193 *	* .33 *	* .37 *	* .491 *	* .64 *	* .57 *	* .627 *	* .81 *	* .67 *	* .685 *
* 120 *	* 30 *	* .06 *	* .10 *	* .193 *	* .25 *	* .33 *	* .504 *	* .47 *	* .48 *	* .627 *	* .62 *	* .57 *	* .679 *
* 90 *	* 10 *	* .06 *	* .08 *	* .127 *	* .31 *	* .25 *	* .229 *	* .44 *	* .33 *	* .282 *	* .48 *	* .36 *	* .299 *
* 90 *	* 20 *	* .06 *	* .08 *	* .122 *	* .28 *	* .23 *	* .214 *	* .40 *	* .31 *	* .262 *	* .44 *	* .33 *	* .278 *
* 90 *	* 30 *	* .05 *	* .07 *	* .118 *	* .26 *	* .21 *	* .200 *	* .37 *	* .28 *	* .243 *	* .40 *	* .30 *	* .257 *
* 60 *	* 10 *	* .14 *	* .10 *	* .072 *	* .90 *	* .56 *	* .353 *	* 1.36 *	* .80 *	* .479 *	* 1.56 *	* .89 *	* .523 *
* 60 *	* 20 *	* -- *	* -- *	* -- *	* -- *	* -- *	* -- *	* -- *	* -- *	* -- *	* -- *	* -- *	* -- *
* 60 *	* 30 *	* -- *	* -- *	* -- *	* -- *	* -- *	* -- *	* -- *	* -- *	* -- *	* -- *	* -- *	* -- *
* 30 *	* 10 *	* .23 *	* .06 *	* .033 *	* .59 *	* .27 *	* .132 *	* .99 *	* .44 *	* .206 *	* 1.20 *	* .52 *	* .237 *
* 30 *	* 20 *	* -- *	* -- *	* -- *	* -- *	* -- *	* -- *	* -- *	* -- *	* -- *	* -- *	* -- *	* -- *
* 30 *	* 30 *	* -- *	* -- *	* -- *	* -- *	* -- *	* -- *	* -- *	* -- *	* -- *	* -- *	* -- *	* -- *
* 0 *	* 10 *	* .00 *	* .00 *	* .000 *	* .00 *	* .00 *	* .000 *	* .00 *	* .00 *	* .000 *	* .00 *	* .00 *	* .000 *
* 0 *	* 20 *	* .00 *	* .00 *	* .000 *	* .00 *	* .00 *	* .000 *	* .00 *	* .00 *	* .000 *	* .00 *	* .00 *	* .000 *
* 0 *	* 30 *	* .00 *	* .00 *	* .000 *	* .00 *	* .00 *	* .000 *	* .00 *	* .00 *	* .000 *	* .00 *	* .00 *	* .000 *

TABLE 33 – GARCIA, POINT 1, ROOT-MEAN-SQUARE LONGITUDINAL RESPONSE, SINGLE AMPLITUDES

```

*****
*                                     LONGITUDINAL DIRECTION                                     *
*                                     SINGLE AMPLITUDES FOR THE DE - 1040                               *
*                                     (POINT 1 : ( 140.17, 0.00, 16.00) )                               *
*****
*HEADING* SHIP *                                     ROOT MEAN SQUARE AMPLITUDE                                     *
* ANGLE * SPEED *                                     *                                     *
* * * * * SIG. WAVE HT. = 4 FT ** SIG. WAVE HT. = 10 FT ** SIG. WAVE HT. = 16 FT ** SIG. WAVE HT. = 20 FT *
* * * * * DISPL. * VEL. * ACCEL. ** DISPL. * VEL. * ACCEL. ** DISPL. * VEL. * ACCEL. ** DISPL. * VEL. * ACCEL. *
* * * * * (FT) * (FT/ * (G) ** (FT) * (FT/ * (G) ** (FT) * (FT/ * (G) ** (FT) * (FT/ * (G) ** (FT) * (FT/ * (G) *
* (DEG) * (KNOTS) * (SEC) * ** (SEC) * ** (SEC) * ** (SEC) *
*****
* 180 * 10 * .03 * .04 * .002 ** .37 * .35 * .011 ** .88 * .67 * .018 ** 1.29 * .88 * .021 *
* 180 * 20 * .02 * .03 * .001 ** .31 * .37 * .014 ** .69 * .67 * .023 ** .96 * .85 * .027 *
* 180 * 30 * .01 * .02 * .001 ** .25 * .34 * .015 ** .56 * .65 * .025 ** .77 * .81 * .030 *
*****
* 150 * 10 * .04 * .05 * .002 ** .40 * .38 * .012 ** .87 * .67 * .018 ** 1.25 * .86 * .021 *
* 150 * 20 * .02 * .04 * .002 ** .33 * .39 * .015 ** .68 * .66 * .023 ** .95 * .82 * .026 *
* 150 * 30 * .01 * .03 * .002 ** .27 * .36 * .016 ** .56 * .63 * .025 ** .76 * .78 * .029 *
*****
* 120 * 10 * .09 * .12 * .005 ** .38 * .38 * .013 ** .70 * .56 * .017 ** .95 * .67 * .018 *
* 120 * 20 * .06 * .09 * .004 ** .32 * .37 * .014 ** .57 * .53 * .018 ** .78 * .63 * .020 *
* 120 * 30 * .04 * .07 * .004 ** .27 * .34 * .015 ** .48 * .50 * .019 ** .65 * .59 * .021 *
*****
* 90 * 10 * .04 * .06 * .003 ** .15 * .12 * .004 ** .36 * .22 * .005 ** .54 * .29 * .006 *
* 90 * 20 * .04 * .05 * .002 ** .14 * .11 * .003 ** .34 * .20 * .005 ** .52 * .27 * .005 *
* 90 * 30 * .03 * .05 * .002 ** .13 * .10 * .003 ** .32 * .19 * .004 ** .49 * .25 * .005 *
*****
* 60 * 10 * .07 * .05 * .001 ** .69 * .39 * .007 ** 1.54 * .76 * .012 ** 2.13 * .99 * .015 *
* 60 * 20 * -- * -- * -- ** -- * -- * -- ** -- * -- * -- ** -- * -- * -- *
* 60 * 30 * -- * -- * -- ** -- * -- * -- ** -- * -- * -- ** -- * -- * -- *
*****
* 30 * 10 * .45 * .08 * .001 ** 1.10 * .46 * .007 ** 2.56 * 1.05 * .014 ** 3.61 * 1.43 * .018 *
* 30 * 20 * -- * -- * -- ** -- * -- * -- ** -- * -- * -- ** -- * -- * -- *
* 30 * 30 * -- * -- * -- ** -- * -- * -- ** -- * -- * -- ** -- * -- * -- *
*****
* 0 * 10 * .98 * .10 * .001 ** 1.51 * .46 * .006 ** 3.04 * 1.11 * .014 ** 4.23 * 1.54 * .018 *
* 0 * 20 * -- * -- * -- ** -- * -- * -- ** -- * -- * -- ** -- * -- * -- *
* 0 * 30 * -- * -- * -- ** -- * -- * -- ** -- * -- * -- ** -- * -- * -- *
*****

```

75

TABLE 34 – GARCIA, POINT 1, ROOT-MEAN-SQUARE LATERAL RESPONSE, SINGLE AMPLITUDES

*****														
LATERAL DIRECTION														
SINGLE AMPLITUDES FOR THE DE - 1040														
(POINT 1 : ( 140.17, 0.00, 16.00 )														
*****														
ROOT MEAN SQUARE AMPLITUDE														
*****														
SIG. WAVE HT. = 4 FT ** SIG. WAVE HT. = 10 FT ** SIG. WAVE HT. = 16 FT ** SIG. WAVE HT. = 20 FT														
*****														
DISPL. * VEL. * ACCEL. ** DISPL. * VEL. * ACCEL. ** DISPL. * VEL. * ACCEL. ** DISPL. * VEL. * ACCEL. *														
*****														
(FT) * (FT/ * (G) ** (FT) * (FT/ * (G) ** (FT) * (FT/ * (G) ** (FT) * (FT/ * (G) ** (FT) * (FT/ * (G) *														
*****														
(DEG) * (KNOTS) * (SEC) * (SEC) * (SEC) * (SEC) * (SEC) * (SEC) * (SEC) * (SEC) * (SEC) * (SEC) * (SEC) * (SEC) * (SEC) *														
*****														
180	10	0.00	0.00	0.000	0.00	0.00	0.000	0.00	0.00	0.000	0.00	0.00	0.000	0.00
	20	0.00	0.00	0.000	0.00	0.00	0.000	0.00	0.00	0.000	0.00	0.00	0.000	0.00
	30	0.00	0.00	0.000	0.00	0.00	0.000	0.00	0.00	0.000	0.00	0.00	0.000	0.00
150	10	.06	.08	.003	.62	.58	.018	1.34	1.04	.028	1.82	1.30	.033	
	20	.04	.06	.004	.43	.51	.020	.92	.87	.030	1.29	1.09	.034	
	30	.03	.05	.004	.31	.43	.020	.63	.72	.030	.89	.89	.034	
120	10	.29	.37	.015	1.36	1.30	.043	2.55	1.98	.056	3.34	2.36	.062	
	20	.20	.31	.015	1.00	1.12	.044	1.96	1.71	.057	2.67	2.07	.063	
	30	.14	.25	.015	.73	.95	.043	1.46	1.43	.055	2.06	1.74	.060	
90	10	.41	.50	.022	1.65	1.32	.039	3.17	2.07	.050	4.19	2.51	.056	
	20	.37	.45	.020	1.69	1.30	.037	3.33	2.13	.050	4.38	2.59	.056	
	30	.34	.41	.018	1.76	1.32	.036	3.50	2.22	.050	4.58	2.70	.057	
60	10	.46	.33	.007	2.70	1.64	.032	4.60	2.53	.046	5.70	2.98	.051	
	20	--	--	--	--	--	--	--	--	--	--	--	--	
	30	--	--	--	--	--	--	--	--	--	--	--	--	
30	10	.89	.13	.002	1.84	.77	.012	3.20	1.37	.019	4.03	1.68	.023	
	20	--	--	--	--	--	--	--	--	--	--	--	--	
	30	--	--	--	--	--	--	--	--	--	--	--	--	
0	10	.00	.00	.000	.00	.00	.000	.00	.00	.000	.00	.00	.000	
	20	.00	.00	.000	.00	.00	.000	.00	.00	.000	.00	.00	.000	
	30	.00	.00	.000	.00	.00	.000	.00	.00	.000	.00	.00	.000	
*****														

TABLE 35 - GARCIA, POINT 1, ROOT-MEAN-SQUARE VERTICAL RESPONSE, SINGLE AMPLITUDES

		VERTICAL DIRECTION											
		SINGLE AMPLITUDES FOR THE DE - 1040											
		(POINT 1 : ( 140.17, 0.00, 16.00) )											
		ROOT MEAN SQUARE AMPLITUDE											
*HEADING*	*SHIP	* SIG. WAVE HT. = 4 FT			* SIG. WAVE HT. = 10 FT			* SIG. WAVE HT. = 16 FT			* SIG. WAVE HT. = 20 FT		
* ANGLE	* SPEED	* DISPL.	* VEL.	* ACCEL.	* DISPL.	* VEL.	* ACCEL.	* DISPL.	* VEL.	* ACCEL.	* DISPL.	* VEL.	* ACCEL.
(DEG)	(KNOTS)	(FT)	(FT/SEC)	(G)	(FT)	(FT/SEC)	(G)	(FT)	(FT/SEC)	(G)	(FT)	(FT/SEC)	(G)
* 180	* 10	* .16	* .23	* .011	* 1.54	* 1.48	* .048	* 3.30	* 2.66	* .075	* 4.44	* 3.30	* .087
	* 20	* .10	* .17	* .010	* 1.52	* 1.82	* .072	* 3.16	* 3.22	* .113	* 4.21	* 3.93	* .130
	* 30	* .06	* .12	* .009	* 1.74	* 2.36	* .104	* 3.66	* 4.39	* .177	* 4.76	* 5.33	* .206
* 150	* 10	* .19	* .26	* .012	* 1.70	* 1.61	* .052	* 3.44	* 2.76	* .077	* 4.55	* 3.37	* .088
	* 20	* .14	* .23	* .012	* 1.70	* 2.00	* .078	* 3.34	* 3.34	* .116	* 4.37	* 4.01	* .132
	* 30	* .10	* .17	* .011	* 1.93	* 2.56	* .111	* 3.79	* 4.44	* .176	* 4.86	* 5.29	* .201
* 120	* 10	* .42	* .52	* .021	* 2.10	* 2.00	* .065	* 3.74	* 2.98	* .085	* 4.78	* 3.48	* .093
	* 20	* .39	* .55	* .026	* 2.14	* 2.38	* .090	* 3.69	* 3.46	* .117	* 4.67	* 3.99	* .127
	* 30	* .32	* .50	* .025	* 2.34	* 2.87	* .117	* 3.97	* 4.21	* .157	* 4.94	* 4.82	* .171
* 90	* 10	* .75	* .90	* .037	* 2.30	* 2.02	* .063	* 3.81	* 2.76	* .075	* 4.80	* 3.17	* .081
	* 20	* .68	* .80	* .032	* 2.17	* 1.88	* .058	* 3.60	* 2.59	* .070	* 4.54	* 2.98	* .075
	* 30	* .64	* .74	* .029	* 2.09	* 1.80	* .055	* 3.47	* 2.49	* .066	* 4.37	* 2.87	* .071
* 60	* 10	* .41	* .31	* .007	* 1.98	* 1.21	* .024	* 3.57	* 1.93	* .034	* 4.64	* 2.33	* .039
	* 20	* .31	* .14	* .002	* 1.62	* .72	* .010	* 3.19	* 1.30	* .017	* 4.30	* 1.68	* .021
	* 30	* .61	* .12	* .002	* 2.35	* .66	* .006	* 4.09	* 1.21	* .011	* 5.28	* 1.56	* .015
* 30	* 10	* .17	* .09	* .001	* 1.46	* .69	* .010	* 3.18	* 1.36	* .019	* 4.36	* 1.78	* .023
	* 20	* .14	* .04	* .002	* 1.59	* .40	* .004	* 3.44	* .91	* .008	* 4.66	* 1.24	* .010
	* 30	* .18	* .10	* .005	* 2.31	* .23	* .006	* 4.66	* .55	* .006	* 6.06	* .79	* .007
* 0	* 10	* .14	* .06	* .001	* 1.30	* .56	* .008	* 3.06	* 1.21	* .015	* 4.29	* 1.63	* .020
	* 20	* .11	* .04	* .001	* 1.36	* .27	* .002	* 3.18	* .70	* .005	* 4.41	* 1.00	* .007
	* 30	* .13	* .11	* .005	* 2.07	* .24	* .007	* 4.47	* .40	* .007	* 5.83	* .55	* .007

TABLE 36 – GARCIA, POINT 2, ROOT-MEAN-SQUARE LONGITUDINAL RESPONSE, SINGLE AMPLITUDES

```

*****
*                                     LONGITUDINAL DIRECTION
*                                     SINGLE AMPLITUDES FOR THE DE - 1040
*                                     (POINT 2 : ( 158.47, 0.00, 16.49) )
*****
*HEADING* SHIP *
* ANGLE * SPEED *
*                                     ROOT MEAN SQUARE AMPLITUDE
*
* SIG. WAVE HT. = 4 FT ** SIG. WAVE HT. = 10 FT ** SIG. WAVE HT. = 16 FT ** SIG. WAVE HT. = 20 FT
*
* DISPL. * VEL. * ACCEL. ** DISPL. * VEL. * ACCEL. ** DISPL. * VEL. * ACCEL. ** DISPL. * VEL. * ACCEL. *
*
* (FT) * (FT/ * (G) ** (FT) * (FT/ * (G) ** (FT) * (FT/ * (G) ** (FT) * (FT/ * (G)
* (DEG) * (KNOTS) * ** (DEG) * (KNOTS) * ** (DEG) * (KNOTS) * ** (DEG) * (KNOTS) *
*****
*
* 180 * 10 * .03 * .04 * .002 ** .37 * .35 * .011 ** .88 * .67 * .018 ** 1.28 * .88 * .021 *
* 180 * 20 * .02 * .03 * .001 ** .32 * .37 * .014 ** .69 * .68 * .023 ** .96 * .85 * .027 *
* 180 * 30 * .01 * .02 * .001 ** .25 * .34 * .015 ** .56 * .65 * .026 ** .77 * .82 * .031 *
*
*****
*
* 150 * 10 * .04 * .05 * .002 ** .40 * .38 * .012 ** .87 * .67 * .018 ** 1.24 * .86 * .021 *
* 150 * 20 * .02 * .04 * .002 ** .34 * .39 * .015 ** .69 * .67 * .023 ** .95 * .83 * .026 *
* 150 * 30 * .02 * .03 * .002 ** .27 * .36 * .016 ** .56 * .64 * .025 ** .76 * .78 * .029 *
*
*****
*
* 120 * 10 * .09 * .12 * .005 ** .38 * .39 * .013 ** .70 * .56 * .017 ** .95 * .67 * .018 *
* 120 * 20 * .07 * .10 * .004 ** .33 * .38 * .015 ** .57 * .54 * .019 ** .77 * .63 * .020 *
* 120 * 30 * .05 * .08 * .004 ** .27 * .35 * .015 ** .49 * .51 * .019 ** .65 * .59 * .021 *
*
*****
*
* 90 * 10 * .04 * .06 * .003 ** .15 * .12 * .004 ** .36 * .22 * .005 ** .54 * .29 * .006 *
* 90 * 20 * .04 * .05 * .002 ** .14 * .11 * .003 ** .34 * .20 * .005 ** .51 * .27 * .005 *
* 90 * 30 * .03 * .05 * .002 ** .13 * .10 * .003 ** .32 * .19 * .004 ** .49 * .25 * .005 *
*
*****
*
* 60 * 10 * .07 * .05 * .001 ** .68 * .38 * .007 ** 1.53 * .76 * .012 ** 2.12 * .99 * .015 *
* 60 * 20 * -- * -- * -- ** -- * -- * -- ** -- * -- * -- ** -- * -- * -- *
* 60 * 30 * -- * -- * -- ** -- * -- * -- ** -- * -- * -- ** -- * -- * -- *
*
*****
*
* 30 * 10 * .45 * .08 * .001 ** 1.10 * .46 * .007 ** 2.55 * 1.05 * .014 ** 3.60 * 1.42 * .018 *
* 30 * 20 * -- * -- * -- ** -- * -- * -- ** -- * -- * -- ** -- * -- * -- *
* 30 * 30 * -- * -- * -- ** -- * -- * -- ** -- * -- * -- ** -- * -- * -- *
*
*****
*
* 0 * 10 * .98 * .10 * .001 ** 1.51 * .46 * .006 ** 3.03 * 1.11 * .014 ** 4.22 * 1.53 * .018 *
* 0 * 20 * -- * -- * -- ** -- * -- * -- ** -- * -- * -- ** -- * -- * -- *
* 0 * 30 * -- * -- * -- ** -- * -- * -- ** -- * -- * -- ** -- * -- * -- *
*****

```

TABLE 37 - GARCIA, POINT 2, ROOT-MEAN-SQUARE LATERAL RESPONSE, SINGLE AMPLITUDES

		LATERAL DIRECTION											
		SINGLE AMPLITUDES FOR THE DE - 1040											
		(POINT 2 : ( 158.47, 0.00, 16.49 )											
HEADING	SHIP	ROOT MEAN SQUARE AMPLITUDE											
ANGLE	SPEED	SIG. WAVE HT. = 4 FT			SIG. WAVE HT. = 10 FT			SIG. WAVE HT. = 16 FT			SIG. WAVE HT. = 20 FT		
		DISPL.	VEL.	ACCEL.	DISPL.	VEL.	ACCEL.	DISPL.	VEL.	ACCEL.	DISPL.	VEL.	ACCEL.
(DEG)	(KNOTS)	(FT)	(FT/SEC)	(G)	(FT)	(FT/SFC)	(G)	(FT)	(FT/SEC)	(G)	(FT)	(FT/SEC)	(G)
180	10	0.00	0.00	0.000	0.00	0.00	0.000	0.00	0.00	0.000	0.00	0.00	0.000
	20	0.00	0.00	0.000	0.00	0.00	0.000	0.00	0.00	0.000	0.00	0.00	0.000
	30	0.00	0.00	0.000	0.00	0.00	0.000	0.00	0.00	0.000	0.00	0.00	0.000
150	10	.07	.09	.004	.67	.63	.020	1.45	1.13	.030	1.96	1.40	.035
	20	.04	.07	.004	.47	.56	.022	.99	.95	.033	1.38	1.18	.038
	30	.03	.06	.004	.34	.47	.022	.67	.79	.033	.94	.96	.037
120	10	.32	.41	.017	1.45	1.40	.047	2.69	2.11	.060	3.50	2.50	.067
	20	.23	.35	.017	1.07	1.22	.048	2.05	1.82	.062	2.77	2.18	.068
	30	.16	.28	.017	.78	1.03	.047	1.51	1.52	.060	2.12	1.83	.065
90	10	.40	.50	.022	1.62	1.29	.038	3.17	2.06	.050	4.19	2.50	.055
	20	.36	.45	.020	1.67	1.28	.036	3.33	2.12	.049	4.39	2.59	.055
	30	.33	.40	.018	1.75	1.30	.035	3.51	2.21	.049	4.60	2.71	.056
60	10	.50	.36	.008	2.94	1.79	.035	4.95	2.75	.050	6.08	3.21	.056
	20	--	--	--	--	--	--	--	--	--	--	--	--
	30	--	--	--	--	--	--	--	--	--	--	--	--
30	10	.91	.15	.002	2.00	.85	.013	3.47	1.50	.021	4.36	1.83	.025
	20	--	--	--	--	--	--	--	--	--	--	--	--
	30	--	--	--	--	--	--	--	--	--	--	--	--
0	10	.00	.00	.000	.00	.00	.000	.00	.00	.000	.00	.00	.000
	20	.00	.00	.000	.00	.00	.000	.00	.00	.000	.00	.00	.000
	30	.00	.00	.000	.00	.00	.000	.00	.00	.000	.00	.00	.000

TABLE 38 - GARCIA, POINT 2, ROOT-MEAN-SQUARE VERTICAL RESPONSE, SINGLE AMPLITUDES

		VERTICAL DIRECTION											
		SINGLE AMPLITUDES FOR THE DE - 1040											
		(POINT 2 : ( 158.47, 0.00, 16.49) )											
		ROOT MEAN SQUARE AMPLITUDE											
		SIG. WAVE HT. = 4 FT			SIG. WAVE HT. = 10 FT			SIG. WAVE HT. = 16 FT			SIG. WAVE HT. = 20 FT		
		DISPL.	VEL.	ACCEL.	DISPL.	VEL.	ACCEL.	DISPL.	VEL.	ACCEL.	DISPL.	VEL.	ACCEL.
(DEG)	(KNOTS)	(FT)	(FT/SEC)	(G)	(FT)	(FT/SEC)	(G)	(FT)	(FT/SEC)	(G)	(FT)	(FT/SEC)	(G)
180	10	.18	.26	.013	1.81	1.74	.057	3.74	3.07	.087	4.95	3.76	.100
	20	.11	.19	.011	1.67	2.00	.079	3.43	3.51	.124	4.54	4.27	.142
	30	.07	.13	.010	1.81	2.48	.110	3.79	4.57	.186	4.91	5.54	.215
150	10	.22	.29	.013	1.97	1.88	.060	3.86	3.15	.089	5.02	3.80	.101
	20	.16	.25	.013	1.84	2.17	.085	3.57	3.60	.126	4.65	4.30	.142
	30	.11	.19	.012	2.00	2.68	.117	3.91	4.60	.184	4.99	5.47	.209
120	10	.47	.59	.024	2.29	2.20	.072	3.97	3.22	.093	5.02	3.74	.102
	20	.41	.59	.028	2.22	2.48	.094	3.79	3.59	.122	4.77	4.12	.132
	30	.34	.53	.027	2.37	2.93	.121	4.00	4.27	.160	4.96	4.87	.175
90	10	.74	.91	.037	2.27	2.00	.063	3.77	2.74	.075	4.76	3.14	.080
	20	.66	.80	.032	2.12	1.84	.057	3.53	2.54	.068	4.46	2.92	.073
	30	.61	.72	.029	2.02	1.74	.053	3.37	2.42	.064	4.25	2.78	.069
60	10	.47	.35	.008	2.15	1.33	.027	3.78	2.07	.037	4.85	2.48	.043
	20	.35	.16	.002	1.74	.77	.011	3.33	1.37	.018	4.44	1.74	.022
	30	.73	.14	.002	2.63	.72	.007	4.42	1.30	.012	5.62	1.66	.016
30	10	.19	.10	.002	1.63	.77	.011	3.46	1.49	.021	4.70	1.93	.025
	20	.17	.05	.002	1.78	.45	.004	3.77	.99	.008	5.05	1.34	.011
	30	.21	.11	.005	2.78	.28	.006	5.62	.66	.007	7.23	.93	.008
0	10	.16	.07	.001	1.47	.63	.009	3.36	1.34	.017	4.65	1.78	.022
	20	.13	.05	.002	1.54	.31	.003	3.52	.78	.006	4.82	1.09	.008
	30	.15	.12	.005	2.37	.28	.007	5.30	.48	.008	6.99	.67	.008



TABLE 39 - GARCIA, POINT 3, ROOT-MEAN-SQUARE LONGITUDINAL RESPONSE, SINGLE AMPLITUDES

		LONGITUDINAL DIRECTION SINGLE AMPLITUDES FOR THE DE - 1040 (POINT 3 : ( 176.77, 0.00, 16.54 ) )											
*HEADING*	*SHIP*	ROOT MEAN SQUARE AMPLITUDE											
*ANGLE*	*SPEED*	SIG. WAVE HT. = 4 FT			SIG. WAVE HT. = 10 FT			SIG. WAVE HT. = 16 FT			SIG. WAVE HT. = 20 FT		
		*DISPL.*	*VEL.*	*ACCEL.*	*DISPL.*	*VEL.*	*ACCEL.*	*DISPL.*	*VEL.*	*ACCEL.*	*DISPL.*	*VEL.*	*ACCEL.*
		(FT)	(FT/SEC)	(G)	(FT)	(FT/SEC)	(G)	(FT)	(FT/SEC)	(G)	(FT)	(FT/SEC)	(G)
(DEG)	(KNOTS)												
	10	.03	.04	.002	.37	.35	.011	.88	.67	.018	1.28	.88	.021
180	20	.02	.03	.001	.32	.37	.014	.69	.68	.023	.96	.86	.027
	30	.01	.02	.001	.25	.34	.015	.56	.66	.026	.77	.82	.031
	10	.04	.05	.002	.40	.38	.012	.87	.67	.018	1.24	.86	.021
150	20	.02	.04	.002	.34	.40	.015	.69	.67	.023	.95	.83	.026
	30	.02	.03	.002	.27	.36	.016	.56	.64	.025	.76	.78	.029
	10	.09	.12	.005	.38	.39	.013	.70	.56	.017	.95	.67	.018
120	20	.07	.10	.005	.33	.38	.015	.57	.54	.019	.77	.63	.020
	30	.05	.08	.004	.27	.35	.015	.49	.51	.019	.65	.59	.021
	10	.04	.06	.003	.15	.12	.004	.36	.22	.005	.54	.29	.006
90	20	.04	.05	.002	.14	.11	.003	.34	.20	.005	.51	.27	.005
	30	.03	.05	.002	.13	.10	.003	.32	.19	.004	.49	.25	.005
	10	.07	.05	.001	.68	.38	.007	1.53	.76	.012	2.12	.99	.015
60	20	--	--	--	--	--	--	--	--	--	--	--	--
	30	--	--	--	--	--	--	--	--	--	--	--	--
	10	.45	.08	.001	1.10	.46	.007	2.55	1.05	.014	3.60	1.42	.018
30	20	--	--	--	--	--	--	--	--	--	--	--	--
	30	--	--	--	--	--	--	--	--	--	--	--	--
	10	.98	.10	.001	1.51	.46	.006	3.03	1.11	.014	4.22	1.53	.018
0	20	--	--	--	--	--	--	--	--	--	--	--	--
	30	--	--	--	--	--	--	--	--	--	--	--	--

TABLE 40 - GARCIA, POINT 3, ROOT-MEAN-SQUARE LATERAL RESPONSE, SINGLE AMPLITUDES

*HEADING*		SHIP		LATERAL DIRECTION											
* ANGLE *		* SPEED *		SINGLE AMPLITUDES FOR THE DE - 1040											
				POINT 3 : ( 176.77, 0.00, 16.54 )											
				ROOT MEAN SQUARE AMPLITUDE											
		SIG. WAVE HT. = 4 FT			SIG. WAVE HT. = 10 FT			SIG. WAVE HT. = 16 FT			SIG. WAVE HT. = 20 FT				
		DISPL.	VEL.	ACCEL.	DISPL.	VEL.	ACCEL.	DISPL.	VEL.	ACCEL.	DISPL.	VEL.	ACCEL.		
(DEG)	(KNOTS)	(FT)	(FT/SEC)	(G)	(FT)	(FT/SEC)	(G)	(FT)	(FT/SEC)	(G)	(FT)	(FT/SEC)	(G)		
180	10	0.00	0.00	0.000	0.00	0.00	0.000	0.00	0.00	0.000	0.00	0.00	0.000		
	20	0.00	0.00	0.000	0.00	0.00	0.000	0.00	0.00	0.000	0.00	0.00	0.000		
	30	0.00	0.00	0.000	0.00	0.00	0.000	0.00	0.00	0.000	0.00	0.00	0.000		
150	10	.07	.10	.004	.72	.68	.022	1.57	1.22	.033	2.12	1.52	.038		
	20	.05	.08	.005	.51	.61	.024	1.06	1.03	.036	1.48	1.27	.041		
	30	.03	.06	.005	.37	.52	.025	.72	.85	.036	1.01	1.04	.041		
120	10	.35	.45	.019	1.55	1.50	.050	2.85	2.25	.065	3.69	2.65	.071		
	20	.25	.38	.019	1.14	1.31	.053	2.15	1.94	.067	2.89	2.31	.073		
	30	.18	.31	.018	.84	1.11	.051	1.58	1.61	.064	2.20	1.93	.070		
90	10	.39	.49	.022	1.61	1.27	.038	3.18	2.05	.049	4.21	2.50	.055		
	20	.35	.44	.020	1.67	1.27	.036	3.35	2.12	.049	4.42	2.60	.055		
	30	.32	.39	.018	1.75	1.29	.035	3.54	2.22	.049	4.64	2.72	.056		
60	10	.54	.38	.009	3.21	1.96	.038	5.33	2.97	.054	6.50	3.45	.060		
	20	--	--	--	--	--	--	--	--	--	--	--	--		
	30	--	--	--	--	--	--	--	--	--	--	--	--		
30	10	.93	.17	.002	2.16	.94	.014	3.76	1.63	.023	4.70	1.98	.027		
	20	--	--	--	--	--	--	--	--	--	--	--	--		
	30	--	--	--	--	--	--	--	--	--	--	--	--		
0	10	.00	.00	.000	.00	.00	.000	.00	.00	.000	.00	.00	.000		
	20	.00	.00	.000	.00	.00	.000	.00	.00	.000	.00	.00	.000		
	30	.00	.00	.000	.00	.00	.000	.00	.00	.000	.00	.00	.000		

TABLE 41 - GARCIA, POINT 3, ROOT-MEAN-SQUARE VERTICAL RESPONSE, SINGLE AMPLITUDES

		VERTICAL DIRECTION											
		SINGLE AMPLITUDES FOR THE DE - 1040											
		(POINT 3 : ( 176.77, 0.00, 16.54 ) )											
*HEADING*	*SHIP*	ROOT MEAN SQUARE AMPLITUDE											
*ANGLE*	*SPEED*	SIG. WAVE HT. = 4 FT			SIG. WAVE HT. = 10 FT			SIG. WAVE HT. = 16 FT			SIG. WAVE HT. = 20 FT		
		*DISPL.*	*VEL.*	*ACCEL.*	*DISPL.*	*VEL.*	*ACCEL.*	*DISPL.*	*VEL.*	*ACCEL.*	*DISPL.*	*VEL.*	*ACCEL.*
		(FT)	(FT/SEC)	(G)	(FT)	(FT/SEC)	(G)	(FT)	(FT/SEC)	(G)	(FT)	(FT/SEC)	(G)
(DEG)	(KNOTS)												
180	10	.20	.29	.014	2.09	2.02	.065	4.22	3.50	.100	5.50	4.24	.114
	20	.12	.21	.012	1.84	2.20	.087	3.76	3.86	.137	4.93	4.67	.157
	30	.07	.14	.011	1.91	2.62	.117	3.96	4.80	.196	5.13	5.80	.227
150	10	.25	.33	.015	2.26	2.17	.070	4.30	3.57	.102	5.53	4.26	.115
	20	.17	.27	.014	2.01	2.37	.093	3.87	3.92	.137	4.99	4.66	.155
	30	.12	.21	.013	2.10	2.82	.124	4.06	4.81	.193	5.17	5.70	.219
120	10	.52	.66	.027	2.51	2.44	.080	4.25	3.50	.103	5.31	4.03	.112
	20	.44	.64	.030	2.33	2.62	.100	3.94	3.75	.128	4.92	4.29	.139
	30	.36	.57	.029	2.43	3.02	.125	4.06	4.37	.166	5.01	4.97	.180
90	10	.74	.92	.038	2.24	1.98	.063	3.73	2.71	.075	4.71	3.11	.080
	20	.65	.79	.033	2.06	1.80	.056	3.46	2.49	.067	4.38	2.86	.072
	30	.59	.71	.029	1.96	1.69	.052	3.27	2.34	.062	4.14	2.70	.067
60	10	.53	.40	.009	2.34	1.46	.029	4.01	2.22	.041	5.09	2.63	.046
	20	.39	.18	.003	1.87	.83	.012	3.49	1.44	.019	4.61	1.82	.023
	30	.84	.16	.002	2.92	.80	.007	4.78	1.40	.013	6.02	1.77	.017
30	10	.21	.11	.002	1.81	.86	.013	3.76	1.63	.023	5.05	2.09	.028
	20	.19	.05	.002	1.98	.50	.004	4.12	1.08	.009	5.47	1.45	.012
	30	.24	.12	.006	3.28	.33	.007	6.65	.77	.008	8.50	1.08	.009
0	10	.17	.08	.001	1.64	.70	.010	3.68	1.47	.019	5.04	1.94	.024
	20	.15	.05	.002	1.73	.34	.003	3.89	.85	.006	5.27	1.18	.009
	30	.17	.14	.006	2.72	.32	.008	6.23	.57	.008	8.28	.80	.009

TABLE 42 - GARCIA, POINT 4, ROOT-MEAN-SQUARE LONGITUDINAL RESPONSE, SINGLE AMPLITUDES

		LONGITUDINAL DIRECTION											
		SINGLE AMPLITUDES FOR THE DE - 1040-											
		(POINT 4 : ( 158.47, -7.30, 16.49) )											
		ROOT MEAN SQUARE AMPLITUDE											
		SIG. WAVE HT. = 4 FT			SIG. WAVE HT. = 10 FT			SIG. WAVE HT. = 16 FT			SIG. WAVE HT. = 20 FT		
		DISPL.	VEL.	ACCEL.	DISPL.	VEL.	ACCEL.	DISPL.	VEL.	ACCEL.	DISPL.	VEL.	ACCEL.
		(FT)	(FT/SEC)	(G)	(FT)	(FT/SEC)	(G)	(FT)	(FT/SEC)	(G)	(FT)	(FT/SEC)	(G)
HEADING	SHIP												
ANGLE	SPEED												
(DEG)	(KNOTS)												
180	10	.03	.04	.002	.37	.35	.011	.88	.67	.018	1.28	.88	.021
	20	.02	.03	.001	.32	.37	.014	.69	.68	.023	.96	.85	.027
	30	.01	.02	.001	.25	.34	.015	.56	.65	.026	.77	.82	.031
150	10	.04	.05	.002	.38	.37	.012	.83	.64	.018	1.21	.82	.020
	20	.02	.04	.002	.33	.38	.015	.66	.64	.022	.91	.79	.025
	30	.01	.03	.002	.26	.35	.015	.54	.62	.024	.73	.75	.028
120	10	.09	.11	.004	.34	.35	.012	.65	.51	.015	.91	.62	.017
	20	.06	.09	.004	.29	.34	.013	.53	.49	.017	.73	.58	.018
	30	.04	.07	.004	.25	.32	.014	.44	.46	.018	.60	.54	.019
90	10	.04	.05	.002	.17	.13	.004	.38	.23	.005	.55	.30	.006
	20	.03	.04	.002	.16	.12	.003	.36	.21	.005	.52	.28	.006
	30	.03	.04	.002	.14	.11	.003	.33	.20	.004	.49	.26	.005
60	10	.06	.04	.001	.61	.33	.006	1.43	.70	.011	2.01	.92	.014
	20	--	--	--	--	--	--	--	--	--	--	--	--
	30	--	--	--	--	--	--	--	--	--	--	--	--
30	10	.48	.08	.001	1.08	.44	.006	2.50	1.02	.013	3.53	1.39	.018
	20	--	--	--	--	--	--	--	--	--	--	--	--
	30	--	--	--	--	--	--	--	--	--	--	--	--
0	10	.98	.10	.001	1.51	.46	.006	3.03	1.11	.014	4.22	1.53	.018
	20	--	--	--	--	--	--	--	--	--	--	--	--
	30	--	--	--	--	--	--	--	--	--	--	--	--

TABLE 43 – GARCIA, POINT 4, ROOT-MEAN-SQUARE LATERAL RESPONSE, SINGLE AMPLITUDES

		LATERAL DIRECTION											
		SINGLE AMPLITUDES FOR THE DE - 1040											
		POINT 4 : ( 158.47, -7.30, 16.49 )											
		ROOT MEAN SQUARE AMPLITUDE											
		SIG. WAVE HT. = 4 FT			SIG. WAVE HT. = 10 FT			SIG. WAVE HT. = 16 FT			SIG. WAVE HT. = 20 FT		
		DISPL.	VEL.	ACCEL.	DISPL.	VEL.	ACCEL.	DISPL.	VEL.	ACCEL.	DISPL.	VEL.	ACCEL.
		(FT)	(FT/SEC)	(G)	(FT)	(FT/SEC)	(G)	(FT)	(FT/SEC)	(G)	(FT)	(FT/SEC)	(G)
HEADING*	SHIP SPEED*												
ANGLE	(KNOTS)												
180	10	0.00	0.00	0.000	0.00	0.00	0.000	0.00	0.00	0.000	0.00	0.00	0.000
	20	0.00	0.00	0.000	0.00	0.00	0.000	0.00	0.00	0.000	0.00	0.00	0.000
	30	0.00	0.00	0.000	0.00	0.00	0.000	0.00	0.00	0.000	0.00	0.00	0.000
150	10	.07	.09	.004	.67	.63	.020	1.45	1.13	.030	1.96	1.40	.035
	20	.04	.07	.004	.47	.56	.022	.99	.95	.033	1.38	1.18	.038
	30	.03	.06	.004	.34	.47	.022	.67	.79	.033	.94	.96	.037
120	10	.32	.41	.017	1.45	1.40	.047	2.69	2.11	.060	3.50	2.50	.067
	20	.23	.35	.017	1.07	1.22	.048	2.05	1.82	.062	2.77	2.18	.068
	30	.16	.28	.017	.78	1.03	.047	1.51	1.52	.060	2.12	1.83	.065
90	10	.40	.50	.022	1.62	1.29	.038	3.17	2.06	.050	4.19	2.50	.055
	20	.36	.45	.020	1.67	1.28	.036	3.33	2.12	.049	4.39	2.59	.055
	30	.33	.40	.018	1.75	1.30	.035	3.51	2.21	.049	4.60	2.71	.056
60	10	.50	.36	.008	2.94	1.79	.035	4.95	2.75	.050	6.08	3.21	.056
	20	--	--	--	--	--	--	--	--	--	--	--	--
	30	--	--	--	--	--	--	--	--	--	--	--	--
30	10	.91	.15	.002	2.00	.85	.013	3.47	1.50	.021	4.36	1.83	.025
	20	--	--	--	--	--	--	--	--	--	--	--	--
	30	--	--	--	--	--	--	--	--	--	--	--	--
0	10	.00	.00	.000	.00	.00	.000	.00	.00	.000	.00	.00	.000
	20	.00	.00	.000	.00	.00	.000	.00	.00	.000	.00	.00	.000
	30	.00	.00	.000	.00	.00	.000	.00	.00	.000	.00	.00	.000

TABLE 44 – GARCIA, POINT 4, ROOT-MEAN-SQUARE VERTICAL RESPONSE, SINGLE AMPLITUDES

```

*****
*                                     VERTICAL DIRECTION                                     *
*                                     SINGLE AMPLITUDES FOR THE DE - 1040                       *
*                                     (POINT 4 : ( 158.47, -7.30, 16.49) )                       *
*                                     *****                                             *
* *HEADING * SHIP *                                     ROOT MEAN SQUARE AMPLITUDE * *
* * ANGLE * SPEED * * * * * * * * * * * * * * * * * * * * * * * * * * * * * * * * * * * *
* * * * * * * * * * * * * * * * * * * * * * * * * * * * * * * * * * * * * * * * * * *
* * SIG. WAVE HT. = 4 FT ** SIG. WAVE HT. = 10 FT ** SIG. WAVE HT. = 16 FT ** SIG. WAVE HT. = 20 FT *
* * * * * * * * * * * * * * * * * * * * * * * * * * * * * * * * * * * * * * * * * * *
* * DISPL. * VEL. * ACCEL. ** DISPL. * VEL. * ACCEL. ** DISPL. * VEL. * ACCEL. ** DISPL. * VEL. * ACCEL. *
* * * * * * * * * * * * * * * * * * * * * * * * * * * * * * * * * * * * * * * * * * *
* * (DEG) * (KNOTS) * (FT) * (FT/ * (G) ** (FT) * (FT/ * (G) ** (FT) * (FT/ * (G) ** (FT) * (FT/ * (G) *
* * * * * * * * * * * * * * * * * * * * * * * * * * * * * * * * * * * * * * * * * * *
* * * * * * * * * * * * * * * * * * * * * * * * * * * * * * * * * * * * * * * * * * *
* * 180 * 10 * .18 * .26 * .013 ** 1.81 * 1.74 * .057 ** 3.74 * 3.07 * .087 ** 4.95 * 3.76 * .100 *
* * 180 * 20 * .11 * .19 * .011 ** 1.67 * 2.00 * .079 ** 3.43 * 3.51 * .124 ** 4.54 * 4.27 * .142 *
* * 180 * 30 * .07 * .13 * .010 ** 1.81 * 2.48 * .110 ** 3.79 * 4.57 * .186 ** 4.91 * 5.54 * .215 *
* * * * * * * * * * * * * * * * * * * * * * * * * * * * * * * * * * * * * * * * * * *
* * * * * * * * * * * * * * * * * * * * * * * * * * * * * * * * * * * * * * * * * * *
* * 150 * 10 * .22 * .29 * .013 ** 2.08 * 1.98 * .063 ** 4.10 * 3.34 * .094 ** 5.29 * 4.02 * .107 *
* * 150 * 20 * .16 * .25 * .013 ** 1.88 * 2.20 * .086 ** 3.69 * 3.69 * .128 ** 4.80 * 4.42 * .145 *
* * 150 * 30 * .11 * .19 * .012 ** 2.01 * 2.69 * .117 ** 3.93 * 4.63 * .185 ** 5.03 * 5.50 * .210 *
* * * * * * * * * * * * * * * * * * * * * * * * * * * * * * * * * * * * * * * * * * *
* * * * * * * * * * * * * * * * * * * * * * * * * * * * * * * * * * * * * * * * * * *
* * 120 * 10 * .49 * .62 * .025 ** 2.53 * 2.39 * .077 ** 4.37 * 3.53 * .101 ** 5.44 * 4.08 * .110 *
* * 120 * 20 * .42 * .61 * .028 ** 2.30 * 2.56 * .097 ** 3.99 * 3.74 * .126 ** 5.02 * 4.31 * .137 *
* * 120 * 30 * .34 * .54 * .027 ** 2.40 * 2.96 * .122 ** 4.06 * 4.32 * .162 ** 5.05 * 4.94 * .176 *
* * * * * * * * * * * * * * * * * * * * * * * * * * * * * * * * * * * * * * * * * * *
* * * * * * * * * * * * * * * * * * * * * * * * * * * * * * * * * * * * * * * * * * *
* * 90 * 10 * .77 * .95 * .039 ** 2.50 * 2.16 * .067 ** 4.07 * 2.97 * .080 ** 5.05 * 3.38 * .086 *
* * 90 * 20 * .69 * .82 * .033 ** 2.27 * 1.95 * .060 ** 3.72 * 2.69 * .072 ** 4.64 * 3.08 * .077 *
* * 90 * 30 * .63 * .74 * .029 ** 2.10 * 1.80 * .055 ** 3.46 * 2.49 * .066 ** 4.34 * 2.86 * .071 *
* * * * * * * * * * * * * * * * * * * * * * * * * * * * * * * * * * * * * * * * * * *
* * * * * * * * * * * * * * * * * * * * * * * * * * * * * * * * * * * * * * * * * * *
* * 60 * 10 * .51 * .38 * .009 ** 2.45 * 1.53 * .031 ** 4.08 * 2.28 * .042 ** 5.12 * 2.68 * .047 *
* * 60 * 20 * .38 * .17 * .003 ** 1.81 * .81 * .011 ** 3.38 * 1.40 * .018 ** 4.48 * 1.77 * .022 *
* * 60 * 30 * .73 * .14 * .002 ** 2.65 * .73 * .007 ** 4.44 * 1.30 * .012 ** 5.64 * 1.66 * .016 *
* * * * * * * * * * * * * * * * * * * * * * * * * * * * * * * * * * * * * * * * * * *
* * * * * * * * * * * * * * * * * * * * * * * * * * * * * * * * * * * * * * * * * * *
* * 30 * 10 * .20 * .11 * .002 ** 1.69 * .80 * .012 ** 3.52 * 1.53 * .021 ** 4.76 * 1.96 * .026 *
* * 30 * 20 * .16 * .04 * .002 ** 1.80 * .45 * .004 ** 3.80 * 1.00 * .008 ** 5.08 * 1.34 * .011 *
* * 30 * 30 * .21 * .11 * .005 ** 2.72 * .28 * .006 ** 5.56 * .66 * .007 ** 7.18 * .93 * .008 *
* * * * * * * * * * * * * * * * * * * * * * * * * * * * * * * * * * * * * * * * * * *
* * * * * * * * * * * * * * * * * * * * * * * * * * * * * * * * * * * * * * * * * * *
* * 0 * 10 * .16 * .07 * .001 ** 1.47 * .63 * .009 ** 3.36 * 1.34 * .017 ** 4.65 * 1.78 * .022 *
* * 0 * 20 * .13 * .05 * .002 ** 1.54 * .31 * .003 ** 3.52 * .78 * .006 ** 4.82 * 1.09 * .008 *
* * 0 * 30 * .15 * .12 * .005 ** 2.37 * .28 * .007 ** 5.30 * .48 * .008 ** 6.99 * .67 * .008 *
*****

```

TABLE 45 – GARCIA, POINT 5, ROOT-MEAN-SQUARE LONGITUDINAL RESPONSE, SINGLE AMPLITUDES

		LONGITUDINAL DIRECTION											
		SINGLE AMPLITUDES FOR THE DE - 1040											
		{POINT 5 : ( 158.47, 0.00, 24.49) }											
*HEADING*	*SHIP*	ROOT MEAN SQUARE AMPLITUDE											
*ANGLE*	*SPEED*	SIG. WAVE HT. = 4 FT			SIG. WAVE HT. = 10 FT			SIG. WAVE HT. = 16 FT			SIG. WAVE HT. = 20 FT		
		DISPL.	VEL.	ACCEL.	DISPL.	VEL.	ACCEL.	DISPL.	VEL.	ACCEL.	DISPL.	VEL.	ACCEL.
(DEG)	(KNOTS)	(FT)	(FT/SEC)	(G)	(FT)	(FT/SEC)	(G)	(FT)	(FT/SEC)	(G)	(FT)	(FT/SEC)	(G)
	10	.04	.05	.002	.45	.44	.014	.90	.74	.021	1.25	.92	.025
180	20	.02	.03	.002	.41	.49	.019	.79	.83	.030	1.03	1.00	.034
	30	.01	.02	.002	.33	.44	.020	.68	.82	.033	.88	.99	.039
	10	.05	.07	.003	.48	.48	.016	.89	.75	.022	1.20	.90	.025
150	20	.03	.05	.002	.43	.51	.020	.78	.81	.029	1.00	.95	.032
	30	.02	.03	.002	.35	.47	.021	.67	.80	.032	.85	.94	.036
	10	.12	.16	.006	.45	.48	.017	.70	.63	.020	.91	.71	.022
120	20	.08	.12	.006	.40	.47	.019	.61	.63	.023	.77	.71	.025
	30	.06	.10	.005	.34	.44	.019	.53	.60	.024	.67	.68	.026
	10	.05	.08	.003	.15	.13	.005	.35	.22	.006	.53	.29	.006
90	20	.05	.07	.003	.13	.12	.004	.32	.20	.005	.49	.26	.006
	30	.05	.07	.003	.12	.10	.004	.29	.18	.005	.45	.24	.005
	10	.06	.04	.001	.60	.33	.006	1.41	.69	.011	1.97	.91	.014
60	20	--	--	--	--	--	--	--	--	--	--	--	--
	30	--	--	--	--	--	--	--	--	--	--	--	--
	10	.45	.08	.001	1.03	.42	.006	2.40	.98	.013	3.40	1.34	.017
30	20	--	--	--	--	--	--	--	--	--	--	--	--
	30	--	--	--	--	--	--	--	--	--	--	--	--
	10	.98	.10	.001	1.46	.44	.006	2.88	1.05	.013	4.02	1.45	.017
0	20	--	--	--	--	--	--	--	--	--	--	--	--
	30	--	--	--	--	--	--	--	--	--	--	--	--

TABLE 46 - GARCIA, POINT 5, ROOT-MEAN-SQUARE LATERAL RESPONSE, SINGLE AMPLITUDES

		LATERAL DIRECTION											
		SINGLE AMPLITUDES FOR THE DE - 1040											
		(POINT 5 : ( 158.47, 0.00, 24.49) )											
		ROOT MEAN SQUARE AMPLITUDE											
		SIG. WAVE HT. = 4 FT			SIG. WAVE HT. = 10 FT			SIG. WAVE HT. = 16 FT			SIG. WAVE HT. = 20 FT		
HEADING	SHIP	DISPL.	VEL.	ACCEL.	DISPL.	VEL.	ACCEL.	DISPL.	VEL.	ACCEL.	DISPL.	VEL.	ACCEL.
ANGLE	SPEED	(FT)	(FT/SEC)	(G)	(FT)	(FT/SEC)	(G)	(FT)	(FT/SEC)	(G)	(FT)	(FT/SEC)	(G)
(DEG)	(KNOTS)												
180	10	0.00	0.00	0.000	0.00	0.00	0.000	0.00	0.00	0.000	0.00	0.00	0.000
	20	0.00	0.00	0.000	0.00	0.00	0.000	0.00	0.00	0.000	0.00	0.00	0.000
	30	0.00	0.00	0.000	0.00	0.00	0.000	0.00	0.00	0.000	0.00	0.00	0.000
150	10	.07	.10	.004	.74	.70	.022	1.47	1.19	.033	1.93	1.44	.038
	20	.05	.07	.004	.51	.60	.024	1.03	1.01	.035	1.39	1.23	.040
	30	.03	.06	.004	.35	.49	.023	.70	.82	.034	.96	.99	.038
120	10	.34	.44	.018	1.59	1.55	.052	2.72	2.23	.066	3.45	2.58	.072
	20	.24	.36	.018	1.15	1.30	.051	2.09	1.91	.066	2.75	2.25	.071
	30	.16	.29	.017	.82	1.06	.049	1.54	1.56	.061	2.12	1.87	.067
90	10	.45	.55	.024	1.64	1.37	.042	3.02	2.03	.052	3.98	2.43	.057
	20	.40	.48	.021	1.64	1.30	.038	3.18	2.06	.049	4.20	2.50	.055
	30	.35	.42	.018	1.72	1.29	.036	3.42	2.17	.049	4.50	2.65	.056
60	10	.54	.40	.009	2.68	1.65	.033	4.56	2.52	.046	5.66	2.96	.052
	20	--	--	--	--	--	--	--	--	--	--	--	--
	30	--	--	--	--	--	--	--	--	--	--	--	--
30	10	.90	.14	.002	1.92	.81	.012	3.34	1.43	.020	4.21	1.76	.024
	20	--	--	--	--	--	--	--	--	--	--	--	--
	30	--	--	--	--	--	--	--	--	--	--	--	--
0	10	.00	.00	.000	.00	.00	.000	.00	.00	.000	.00	.00	.000
	20	.00	.00	.000	.00	.00	.000	.00	.00	.000	.00	.00	.000
	30	.00	.00	.000	.00	.00	.000	.00	.00	.000	.00	.00	.000



TABLE 47 - GARCIA, POINT 5, ROOT-MEAN-SQUARE VERTICAL RESPONSE, SINGLE AMPLITUDES

		VERTICAL DIRECTION SINGLE AMPLITUDES FOR THE DE - 1040 {POINT 5 : ( 158.47, 0.00, 24.49) }											
*HEADING*	*SHIP*	ROOT MEAN SQUARE AMPLITUDE											
*ANGLE*	*SPEED*	SIG. WAVF HT. = 4 FT			SIG. WAVE HT. = 10 FT			SIG. WAVE HT. = 16 FT			SIG. WAVE HT. = 20 FT		
		*DISPL.*	*VEL.*	*ACCEL.*	*DISPL.*	*VEL.*	*ACCEL.*	*DISPL.*	*VEL.*	*ACCEL.*	*DISPL.*	*VEL.*	*ACCEL.*
		(FT)	(FT/SEC)	(G)	(FT)	(FT/SEC)	(G)	(FT)	(FT/SEC)	(G)	(FT)	(FT/SEC)	(G)
(DEG)	(KNOTS)												
180	10	.18	.26	.013	1.81	1.74	.057	3.74	3.07	.087	4.95	3.76	.100
	20	.11	.19	.011	1.67	2.00	.079	3.43	3.51	.124	4.54	4.27	.142
	30	.07	.13	.010	1.81	2.48	.110	3.79	4.57	.186	4.91	5.54	.215
150	10	.22	.29	.013	1.97	1.88	.060	3.86	3.15	.089	5.02	3.80	.101
	20	.16	.25	.013	1.84	2.17	.085	3.57	3.60	.126	4.65	4.30	.142
	30	.11	.19	.012	2.00	2.68	.117	3.91	4.60	.184	4.99	5.47	.209
120	10	.47	.59	.024	2.29	2.20	.072	3.97	3.22	.093	5.02	3.74	.102
	20	.41	.59	.028	2.22	2.48	.094	3.79	3.59	.122	4.77	4.12	.132
	30	.34	.53	.027	2.37	2.93	.121	4.00	4.27	.160	4.96	4.87	.175
90	10	.74	.91	.037	2.27	2.00	.063	3.77	2.74	.075	4.76	3.14	.080
	20	.66	.80	.032	2.12	1.84	.057	3.53	2.54	.068	4.46	2.92	.073
	30	.61	.72	.029	2.02	1.74	.053	3.37	2.42	.064	4.25	2.78	.069
60	10	.47	.35	.008	2.15	1.33	.027	3.78	2.07	.037	4.85	2.48	.043
	20	.35	.16	.002	1.74	.77	.011	3.33	1.37	.018	4.44	1.74	.022
	30	.73	.14	.002	2.63	.72	.007	4.42	1.30	.012	5.62	1.66	.016
30	10	.19	.10	.002	1.63	.77	.011	3.46	1.49	.021	4.70	1.93	.025
	20	.17	.05	.002	1.78	.45	.004	3.77	.99	.008	5.05	1.34	.011
	30	.21	.11	.005	2.78	.28	.006	5.62	.66	.007	7.23	.93	.008
0	10	.16	.07	.001	1.47	.63	.009	3.36	1.34	.017	4.65	1.78	.022
	20	.13	.05	.002	1.54	.31	.003	3.52	.78	.006	4.82	1.09	.008
	30	.15	.12	.005	2.37	.28	.007	5.30	.48	.008	6.99	.67	.008

## REFERENCES

1. Salvesen, N. et al., "Ship Motions and Sea Loads," Transactions of The Society of Naval Architects and Marine Engineers, Vol. 78, pp. 250–287 (1970).
2. Meyers, W.G. and S.L. Bales, "Manual: NSRDC Irregular Sea Response Prediction Computer Program," NSRDC Report 4011 (1973).
3. St. Denis, M. and W.J. Pierson, "On the Motion of Ships in Confused Seas," Transactions of The Society of Naval Architects and Marine Engineers, Vol. 61, pp. 280–357 (1953).
4. Kizer, C.R. and G.D. Carico, "Final Report Navy Evaluation of the Helicopter Hauldown System," Naval Air Test Center Technical Report FT-20R-69 (Mar 1969).
5. Parkinson, R. et al., "Final Report Evaluation of the DE-1052-Class Destroyer for HH-2D Helicopter Operations," Naval Air Test Center Technical Report FT-4R-71 (Feb 1971).
6. Parkinson, R. and G. Hurley, "Fifth Interim Report, LAMPS Support and Monitor (Evaluation of the DE-1040-Class Destroyer for HH-2D Helicopter Operations)," Naval Air Test Center Technical Report FT-41R-71 (May 1971).
7. Lineback, H.W. and A.B. Hill, "First Interim Report Helicopter/VSTOL Compatibility Program (DLG-26/SH-2D Dynamic Interface Flight Envelope)," Naval Air Test Center Report of Test Results FT-91R-71 (Dec 1971).
8. Pierson, W.J. Jr. et al., "Practical Methods for Observing and Forecasting Ocean Waves by Means of Wave Spectra and Statistics," U.S. Navy Hydrographic Office Publication 603 (1955).
9. Conolly, J.E., "Rolling and its Stabilization by Active Fins," Quarterly Transactions of The Royal Institution of Naval Architects, Vol. 3, No. 1, pp. 21–48 (1969).
10. Whicker, L.F. and L.F. Fehlner, "Free-Stream Characteristics of a Family of Low-Aspect Ratio, All Movable Control Surfaces for Application to Ship Design," David Taylor Model Basin Report 933 (1958).

INITIAL DISTRIBUTION

Copies

Copies

1	USAWES	1	NAVSHIPYD HUNTERS PT
1	CNA	1	NAVSHIPYD LBEACH
1	CHONR 438	1	NAVSHIPYD MARE
1	CHONR 461	1	NAVSHIPYD MARE 250
1	PM-15	1	NAVSHIPYD PEARL
1	PM-17/E. Butler	1	NAVSHIPYD PHILA
1	ONR BOSTON	1	NAVSHIPYD PTSMH
1	ONR CHICAGO	1	NAVSHIPYD PUGET SOUND
1	ONR PASADENA	1	SEC 6034B
1	NRL	1	SEC 6110
1	USNA	1	SEC 6114H
1	NAVPGSCOL	1	SEC 6120
1	NROTC & NAVADMINU, MIT	1	SEC 6136
1	NAVWARCOL	1	SEC 6144G
2	SHIPS 2052	1	SEC NORVA 6660/D. Blount
1	SHIPS 03412	1	NAVAIRTESTCEN/Rotary Wing
1	SHIPS 0342	12	DDC
5	AIR 530211/D. Lindquist	1	LC
1	AIR 5372F/E. Lynch	1	USMMA
4	AIR 6041A	1	USMMA/Natl Maritime Res Cen
1	FAC 032C	1	DOT
1	NAVOCEANO/Ocean Dyn	1	U Cal Berkeley NAME
1	NAVAIRDEVCEN/Vehicle Technol	1	U Cal Berkeley NAME/J. Paulling
1	NELC	1	U Cal Berkeley NAME/W. Webster
1	NAVWPNSCEN	1	U Cal Berkeley NAME/J. Wehausen
1	NAVUSEACEN	1	U Cal Scripps/Lib
5	NAVUSEACEN 655	1	CIT/Aero Lib
1	CIVENGLAB	1	CIT/T. Wu
1	NOL	1	Florida Atlantic U/Ocean Engr
1	NWL	1	U Hawaii Ocean Engr/C. Bretschneider
1	NPTLAB NUSC	1	U Iowa IHR
1	NLONLAB NUSC	1	Long Island U/D. Price
1	NAVSHIPYD BSN	1	MIT Ocean Engr
1	NAVSHIPYD CHASN		

## Copies

1 MIT Ocean Engr/M. Abkowitz  
 1 MIT Ocean Engr/P. Mandel  
 1 MIT Ocean Engr/J. Newman  
 1 U Michigan NAME  
 1 U Michigan NAME/R. Couch  
 1 U Michigan NAME/F. Hammitt  
 1 U Michigan NAME/T. Ogilvie  
 1 U Michigan Willow Run Labs  
 1 U Minnesota SAFHL/C. Song  
 1 New York U/W. Pierson  
 1 New York U/Res Bldg 3  
 1 Notre Dame/Coll Engr  
 1 SWRI/Applied Mech Rev  
 1 SWRI/H. Abramson  
 1 Stanford U/R. Street  
 1 Stanford Res Inst  
 1 SIT Lib  
 1 SIT/J. Breslin  
 1 SIT/S. Tsakonas  
 1 U Washington APL  
 1 Webb Inst/E. Lewis  
 1 Webb Inst/L. Ward  
 1 WHOI/Ocean Engr  
 1 SNAME  
 1 AIL Div Cutler Hammer/F. Kelly  
 1 American Nucleonics/E. Warren  
 1 Bell Aerosystems  
 1 Bell Helicopter/D. DeLong  
 1 Bethlehem Steel New York  
 1 Bethlehem Steel Sparrows Point  
 1 Boeing/Vertol  
 1 Bolt Beranek & Newman  
 1 Cornell Aero Lab  
 1 Eastern Res Group  
 1 Esso/Des Div Tanker Dept  
 1 Fairchild Republic Div

## Copies

1 Gen Dyn/Convair  
 1 Gen Dyn Elec Boat/V. Boatwright  
 1 Gibbs & Cox  
 1 Gyrodyne  
 1 Hughes Tool/Aircraft Div  
 1 Hydronautics  
 1 Kaman Aerospace/B. Goodale  
 1 LTV Aerospace  
 1 Lockheed M&S/R. Waid  
 1 McDonnell-Douglas  
 1 Newport News Shipbuilding  
 1 North American Rockwell/Missile Sys  
 1 Oceanics/P. Kaplan  
 1 Raytheon/Missile Sys/B. Hunt  
 1 Sperry Sys Mgmt  
 1 Sun Shipbuilding  
 1 Robert Taggart  
 1 Teledyne Ryan Aeronautical/C. Davis  
 1 Tracor  
 1 United Aircraft/Sikorsky

## CENTER DISTRIBUTION

1 15 W. Cummins  
 1 1502 G. Stuntz  
 1 1506 M.K. Ochi  
 1 1509 H. Pollard  
 1 152 R. Wermter  
 1 154 W. Morgan  
 1 1552 N. Salvesen  
 1 156 J. Hadler  
 1 1564 J. Feldman  
 1 1568 G. Cox  
 1 1568 L. Ruth  
 1 1568 E. Zarnick  
 1 1568 A. Baitis  
 1 1568 K. Bales  
 1 1568 H. Jones

Copies

1	1568	D. Woolaver
1	1568	G. Rossignol
1	1568	W. Meyers
1	1568	S. Bales
1	1572	M. Ochi
1	1576	W. Smith



DOCUMENT CONTROL DATA - R & D		
<i>(Security classification of title, body of abstract and indexing annotation must be entered when the overall report is classified)</i>		
1 ORIGINATING ACTIVITY (Corporate author) Naval Ship Research and Development Center Bethesda, Maryland 20034		2a. REPORT SECURITY CLASSIFICATION UNCLASSIFIED
		2b. GROUP
3 REPORT TITLE  RESPONSE PREDICTIONS OF HELICOPTER LANDING PLATFORM FOR THE USS BELKNAP (DLG-26) AND USS GARCIA (DE-1040)-CLASS DESTROYERS		
4 DESCRIPTIVE NOTES (Type of report and inclusive dates)		
5 AUTHOR(S) (First name, middle initial, last name)  Susan Lee Bales, William G. Meyers and Grant A. Rossignol		
6 REPORT DATE  July 1973	7a. TOTAL NO. OF PAGES  102	7b. NO. OF REFS  10
8a. CONTRACT OR GRANT NO	9a. ORIGINATOR'S REPORT NUMBER(S)  3868	
b. PROJECT NO WR-2-0210	9b. OTHER REPORT NO(S) (Any other numbers that may be assigned this report)  <b>AD 766 450</b>	
c. 1568-302		
d. Work Unit 1-1568-302		
10 DISTRIBUTION STATEMENT  APPROVED FOR PUBLIC RELEASE: DISTRIBUTION UNLIMITED		
11 SUPPLEMENTARY NOTES	12 SPONSORING MILITARY ACTIVITY  NAVUSEARANDCEN	
13 ABSTRACT  Motion-response predictions of the helicopter landing platform for the USS BELKNAP (DLG-26) and USS GARCIA (DE-1040)-Class destroyers are presented. Predictions have been obtained by a computer-implemented procedure, which calculates response statistics at an arbitrary point on a ship in long-crested, irregular seas. The procedure is based on ship-motion theories in the state of the art. Results are presented for several ship speeds, states of sea, and ship headings—ranging from head to following waves. Existing envelopes of helicopter operations are discussed, and suggestions have been made, based upon the results of this study, for the listed new operational envelopes in higher states of seas:  1. Responses other than roll, e.g., vertical response at the landing platform, must be considered,  2. Quartering sea landings may be safer than bow sea landings,  3. To increase safety of operations, BELKNAP should be stabilized in roll.		

14 KEY WORDS	LINK A		LINK B		LINK C	
	ROLE	WT	ROLE	WT	ROLE	WT
Seaworthiness Helicopter Platform Responses Destroyers						





4

3

0

5

3

2

MAR 26 1979