

R.761254



Report 3875

MIT LIBRARIES



3 9080 02753 7502

# NAVAL SHIP RESEARCH AND DEVELOPMENT CENTER

Bethesda, Md. 20034



V393  
.R46

## LOW COST, HIGH ACCURACY INSTRUMENTATION TAPE RECORDER

by

Robert G. Stilwell



APPROVED FOR PUBLIC RELEASE;  
DISTRIBUTION UNLIMITED

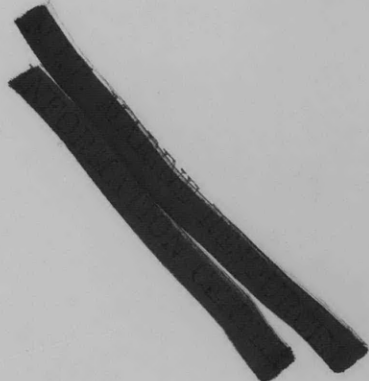

CENTRAL INSTRUMENTATION DEPARTMENT  
RESEARCH AND DEVELOPMENT REPORT

December 1972

Report 3875

LOW COST, HIGH ACCURACY INSTRUMENTATION TAPE RECORDER

The Naval Ship Research and Development Center is a U. S. Navy center for laboratory effort directed at achieving improved sea and air vehicles. It was formed in March 1967 by merging the David Taylor Model Basin at Carderock, Maryland with the Marine Engineering Laboratory at Annapolis, Maryland.

Naval Ship Research and Development Center  
Bethesda, Md. 20034

### MAJOR NSRDC ORGANIZATIONAL COMPONENTS

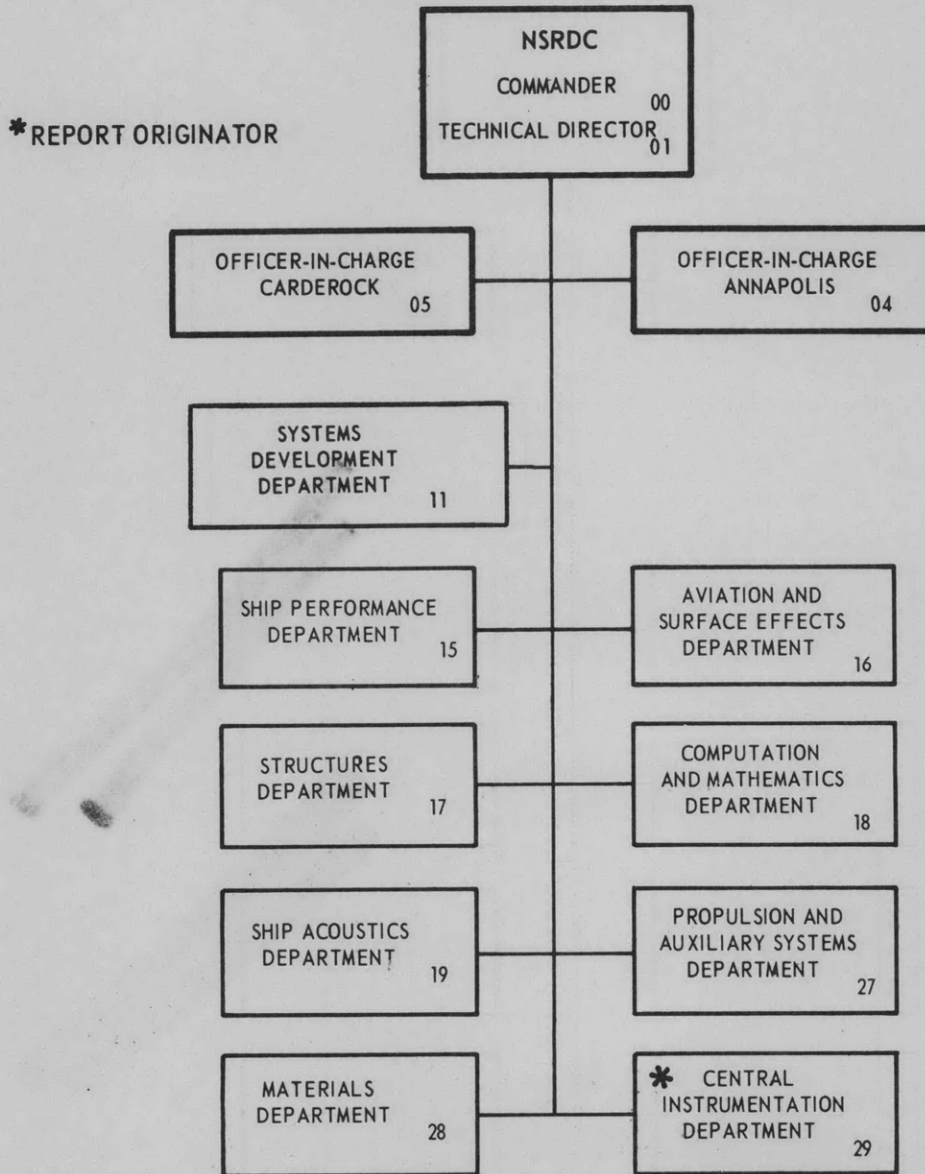

DEPARTMENT OF THE NAVY  
NAVAL SHIP RESEARCH AND DEVELOPMENT CENTER  
BETHESDA, MD. 20034

LOW COST, HIGH ACCURACY INSTRUMENTATION  
TAPE RECORDER

by

Robert G. Stilwell

APPROVED FOR PUBLIC RELEASE;  
DISTRIBUTION UNLIMITED

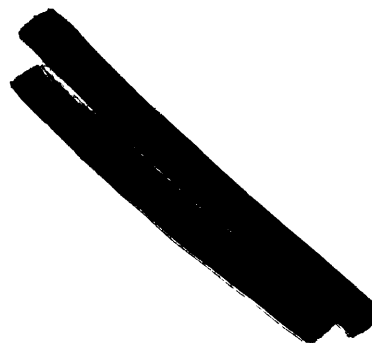

December 1972

Report 3875

## SUMMARY

### STATEMENT OF PROBLEM

Develop an instrumentation quality magnetic tape recorder which utilizes a new recording technique: differential pulse width modulation. Demonstrate the probable advantages: low cost, high accuracy, light weight, and ease of operation. Provide the recorder with analog outputs for field or laboratory use, and digital outputs for reproducing analog data directly into a high-speed digital computer. Use this recorder to investigate the entire data recording and retrieval process and determine overall system performance from the computer-reduced data.

### CONCLUSIONS

The recorder fulfills or exceeds each of the initial objectives. It possesses several important advantages over the modern instrumentation recorders currently being used in Navy technical programs. It is more highly accurate than any but the best (and most expensive) commercial instrumentation recorders; it is light in weight since no high-inertia components are required; and it is less costly to produce and to operate (less than one-third that of commercial recorders). Additionally it will simultaneously produce analog outputs for chart or oscilloscope display and digital outputs for playback into a digital computer without any intermediate format translations.

The equipment developed to date has demonstrated frequency response capability to 2500 Hz, sufficient for most Navy applications. This response and the resultant digital bit rate challenge modern "high-speed" digital computer capabilities.

### RECOMMENDATIONS

1. Although the additional digital bit rate required presently precludes increasing the recorder "digital bandwidth" techniques should be developed to extend the bandwidth for analog outputs.

2. Methods should be investigated for more direct access to high-speed digital computers than those used in this development. This can further reduce data reduction time, the amount of equipment involved, and hence the cost.

A production development program (perhaps conducted by commercial concerns) should be initiated to refine the properties of the tape recorder.

## TABLE OF CONTENTS

	Page
ABSTRACT .....	1
ADMINISTRATIVE INFORMATION .....	1
INTRODUCTION .....	1
HISTORY OF THE DEVELOPMENT OF THE NSRDC DIGITAL MAGNETIC TAPE RECORDER (DMTR) .....	2
INITIAL OBJECTIVES .....	2
DIFFERENTIAL PULSE WIDTH MODULATION (DPWM) CONCEPT .....	3
DPWM AND MAGNETIC TAPE RECORDING .....	3
ANALOG AND DIGITAL UTILIZATION .....	3
THE 300 HZ MODEL DMTR .....	3
THE MODEL 300 PROTOTYPE .....	4
DIFFERENTIAL PULSE WIDTH MODULATION (DPWM) .....	4
DPWM ARCHITECTURE .....	5
PWM AND DPWM DISSIMILARITY .....	7
CONSIDERATIONS OF TIME-VARYING DATA .....	7
ADVANTAGES OF THE DPWM FORMAT FOR TAPE RECORDING .....	9
A SYSTEM VIEW OF THE DMTR CONCEPT .....	10
DATA ACQUISITION AND REPRODUCTION FUNCTION .....	12
Recording Process .....	12
Reproduce Process .....	13
Analog Demodulation .....	17
Digital Demodulation .....	20
Computer Interface Techniques .....	24
ADVANTAGES AND LIMITATIONS OF THE DMTR CONCEPT .....	25
DESCRIPTION AND EVALUATION OF MODEL 300 .....	26
SALIENT PARAMETERS AND SPECIFICATIONS .....	26
CIRCUITS OF THE SUBSYSTEMS .....	30
Block Diagram (Figure 14) .....	30
Tape Transport Schematic (Figure 15) .....	32
Card Rack Interconnecting Diagram (Figure 16) .....	32
Triangle Generator (Figure 17) .....	32
Record Card (Figure 18) .....	36
Reproduce Card (Figure 19) .....	36
Five-Pole Butterworth Filter Analog Demodulator (Figure 20) .....	39
Differential Staggered Incremental Demodulator DSID (Figure 21) .....	39
Digital Interface Electronics (Figure 22) .....	39

	Page
MODEL 300 DMTR EVALUATION .....	43
Analog Tests .....	46
Digital Tests .....	50
OTHER USES OF THE CONCEPTS .....	57
RECOMMENDATIONS .....	62
ACKNOWLEDGMENTS .....	62
APPENDIX A – CONSIDERATIONS OF DPWM STIMULATED BY STATIC AND DYNAMIC DATA .....	63
APPENDIX B – DIGITAL INTERFACING TECHNIQUES (HARDWARE AND SOFTWARE) USED WITH THE DMTR MODEL 300 .....	71
APPENDIX C – DISTRIBUTIONS OF DYNAMIC DATA POINTS FROM DIGITAL EVALUATION BY CDC 6700 COMPUTER .....	73

### LIST OF FIGURES

Figure 1 – Differential Pulse Width Modulation .....	6
Figure 2 – Typical Data Storage in Differential Pulse Width Modulation .....	6
Figure 3 – Conventional Pulse Width Modulation .....	8
Figure 4 – Differential Pulse Width Modulation Waveforms .....	8
Figure 5 – Typical Digital Magnetic Tape Recorder Scheme .....	11
Figure 6 – Details of Record Process .....	15
Figure 7 – Recorded and Reproduced Digital Magnetic Tape Recorder Signals .....	15
Figure 8 – Typical Reproduced Pulse of Various Possible Amplitudes .....	15
Figure 9 – Basic Operation of the Differential Staggered Incremental Demodulator .....	18
Figure 10 – Waveforms of the Differential Staggered Incremental Demodulator .....	19
Figure 11 – Typical Digital Demodulation Using a Phase-Locked Loop .....	22
Figure 12 – Model 300 Digital Magnetic Tape Recorder Prototype .....	27
Figure 13 – Enlarged Section of Digital Magnetic Tape Recorder Tape and Recorded Differential Pulse Width Modulation Signals .....	28

	Page
Figure 14 – Model 300 Block Diagram .....	31
Figure 15 – Model 300 Tape Transport .....	33
Figure 16 – Model 300 Card Rack Interconnections .....	34
Figure 17 – Model 300 Triangle Generator .....	35
Figure 18 – Model 300 Record Card .....	37
Figure 19 – Model 300 Reproduce Card .....	38
Figure 20 – Model 300 Low-Pass Filter Analog Demodulator .....	40
Figure 21 – Model 300 Differential Staggered Incremental Demodulator .....	41
Figure 22 – Digital Interface Electronics General Arrangement .....	42
Figure 23 – Digital Interface Electronics – Gating Modules and Phase-Locked Loop .....	44
Figure 24 – Digital Interface Electronics Counter .....	45
Figure 25 – Analog Evaluation Test Setup .....	49
Figure 26 – Error Curves for Channels 2 and 6 (Analog Playback) .....	49
Figure 27 – Analog Frequency Response .....	49
Figure 28 – Error Curves for $v_1$ with and without a Phase-Locked Loop .....	55
Figure 29 – Error Curve for $v_2$ Using a Phase-Locked Loop .....	56
Figure 30 – Partial Computer Plot of File 42 Showing $v_1$ Points for 10-Hz Sine Wave .....	58
Figure 31 – Partial Computer Plot of File 42 Showing $v_2$ Points for 10-Hz Sine Wave .....	59
Figure 32 – Partial Computer Plot of File 43 Showing $v_1$ Points for 100-Hz Sine Wave .....	60
Figure 33 – Partial Computer Plot of File 43 Showing $v_2$ Points for 100-Hz Sine Wave .....	61

	Page
<b>APPENDIX</b>	
Figure A1 – Normalized Differential Pulse Width Modulation Sample .....	69
Figure A2 – The Sampling Function .....	69
Figure A3 – Intersection of a Ramp with Differential Pulse Width Modulation Triangular Carrier .....	69

### LIST OF TABLES

Table 1 – Model 300 Digital Magnetic Tape Recorder Specifications .....	29
Table 2 – Contents of Model 300 Evaluation Tape TT-1 .....	47
Table 3 – Data from Analog Evaluation Using Static Levels .....	47
Table 4 – Frequency Response Data for Digital Magnetic Tape Recorder Analog Evaluation with Low-Pass Filter .....	48
Table 5 – Summary of Digital Evaluation Results for the Static Files .....	52



## NOTATION AND ABBREVIATIONS

$A$	The $A$ counter output count for the DPWM positive portion
AM	Amplitude Modulation
$B$	The $B$ counter output count for the DPWM negative portion
bpi	Bits per inch
DMTR	Digital Magnetic Tape Recorder
DPWM	Differential Pulse Width Modulation
DSID	Differential Staggered Incremental Demodulator
DTL	Diode-Transistor Logic
FM	Frequency Modulation
$f_c$	DPWM average carrier frequency
$f_m$	Modulating frequency
$f_r$	Triangular wave frequency
$m_c$	Slope of triangular wave
$m_m$	Slope of modulating signal
PAM	Pulse Amplitude Modulation
PCM	Pulse Code Modulation
PLL	Phase-Locked Loop
PM	Phase Modulation
PPM	Pulse Position Modulation
PWM	Pulse Width Modulation
SYMMETRY, $P$	The portion of the DPWM sample which is positive expressed as a percentage
TTL	Transistor-Transistor Logic
$t_s$	Switchover time of DPWM sample
$V_1$	The voltage calculated from the digital data from the equation

$$V_1 = \left[ \frac{512 A}{A + B} - 256 \right] / 100$$

$V_2$  The voltage calculated from the digital data from the equation

$$V_2 = (A - 256) / 100$$

$v_c, v_r$	Triangular wave voltage
$v_m$	Modulating voltage
$\sigma_1$	The standard deviation of $V_1$
$\sigma_2$	The standard deviation of $V_2$

## ABSTRACT

This report describes a new magnetic tape recording system for general instrumentation use. The system uses a new type of modulation format and offers excellent performance at low cost. The system concepts are explored from a subsystem or "block diagram" viewpoint, and extensions of these concepts are hypothesized. An actual prototype is described, its specifications and performance parameters given, and the results of its evaluation program presented. The history of the system from 1967 to 1971 is also included for completeness. The differential pulse width modulation (DPWM) concept is considered to represent a truly significant advance in modulation techniques.

## ADMINISTRATIVE INFORMATION

The work described herein was performed by the Central Instrumentation Department (Code 29) as part of the in-house Independent Exploratory Development (IED) Program of the Naval Ship Research and Development Center (NSRDC). Funding was provided under Program Element 62713N, Project FXX412, Task Area ZFXX412001.

A United States patent to protect this work has been applied for as Navy Case 50,526.

## INTRODUCTION

Instrumentation tape recorders suitable for recording physical phenomena are notoriously deficient. Their accuracy and precision, cost, operability, and maintainability often leave much to be desired. In addition, their output format is generally not suited for direct entry into a digital computer.

It is generally recognized that these deficiencies stem directly from the frequency modulation (FM) format used in almost all of these recorders. Accuracy in this format is directly dependent on the precision with which tape speed is maintained during recording and playback. This dependency has led to large, heavy, sophisticated, precision tape-handling mechanisms which are difficult to operate and maintain. Moreover, the accuracies obtained are not commensurate with costs.

Magnetic tape is a proven means for high-speed data entry into a digital computer, but the FM format prohibits direct data entry because demodulation and analog-to-digital conversion are required as intermediate operations. However, the Center has long recognized the advantages of introducing field-recorded data directly into a digital computer for reduction. Modern digital computers handle data at fantastically high rates, thereby providing tremendous potential for achieving economics through computer reduction and analysis of experimental data.

In 1966 a new format called differential pulse width modulation (DPWM) was devised at the Center. The DPWM format was specifically devised for machine handling. Utilization of DPWM with the magnetic tape recorder has many apparent intrinsic advantages; these include high accuracy with unsophisticated tape-handling mechanisms and direct data entry into digital computers without intermediate transcription. The DPWM concept was investigated on a small scale by using an inexpensive tape transport with new electronics. The significant results obtained were very rewarding, and the value of DPWM tapes for direct access to digital computers was confirmed. Moreover a substantial improvement in precision and accuracy over competing techniques was obtained. It was further demonstrated that the expensive mechanisms required for precision tape speed control are not required for accurate data recording. The potential for tremendous reductions in tape equipment costs was therefore established. It is estimated that utilization of the DPWM techniques can eventually reduce the Navy's capital investment in tape recording and reproducing equipment by two-thirds in addition to reducing data-handling and equipment maintenance costs and improving accuracy.

This IED program was completed in October 1971. Three prototype recorders have been constructed. The last, "Model 300," has a 2500 Hz bandwidth and can record six channels simultaneously on 1/4-in.-wide tape. A tape speed of 60 ips provides a bandwidth of 2500 Hz. This is considered sufficient for most Navy work. Performance evaluation data from Model 300 reported herein were reduced by a CDC 6700; they clearly demonstrate the superiority of the DMTR over commercial recorders in almost every respect. This document is the final report for this IED program. It can also mark the beginning of a significant reduction in the cost of gathering and reducing data, a decrease in data-handling time, and an improvement in the performance of data-handling equipment.

## HISTORY OF THE DEVELOPMENT OF THE NSRDC DIGITAL MAGNETIC TAPE RECORDER (DMTR)

### INITIAL OBJECTIVES

The initial objectives were:

1. To develop a quality instrumentation magnetic tape recorder which utilizes a new recording technique: differentiation pulse width modulation.
2. To demonstrate the anticipated advantages of low cost, high accuracy, light weight, and ease of operation.
3. To provide the recorder with analog outputs for field or laboratory use and with digital outputs for reproducing analog data directly into a high-speed digital computer.
4. To use this recorder to investigate the entire data recording and retrieval process and to utilize the computer-reduced data to evaluate overall system performance.

## **DIFFERENTIAL PULSE WIDTH MODULATION (DPWM) CONCEPT**

Originally the DPWM concept was devised as a method for overcoming certain problems which plagued other modulation formats. The most glaring of these problems was the demodulation errors that were produced in the low-pass filter of an FM demodulator. These errors are now easily avoidable due to the equally distributed energy centers of the DPWM signal, and it is felt that the concept represents a truly significant advance in modulation techniques. It was soon rationalized that application of the DPWM format to magnetic tape recording could produce revolutionary results. The true value of DPWM had thus been discovered.

## **DPWM AND MAGNETIC TAPE RECORDING**

At this stage, an IED program for the functional evaluation of this new concept was proposed and approved. An inexpensive (\$230) audio tape recorder was purchased and modified for this feasibility evaluation; only one channel of intelligence was provided. Even though the construction was crude and the bandwidth was limited to 10 Hz, this recorder demonstrated its capabilities well by recording and reproducing data to an accuracy of  $\pm 2$  percent. This first recorder further demonstrated that through the principles of phase-locked-loops (PLL's), reproduced data could be retrieved in a form suitable for direct entry into a high-speed digital computer.

## **ANALOG AND DIGITAL UTILIZATION**

During this feasibility evaluation period, several schemes were devised to retrieve the reproduced data in analog form. Excellent results were achieved. It was found that unlike the FM format, DPWM could be demodulated accurately regardless of tape speed, wow, or flutter. Thus, there existed schemes for data reproduction in either analog or digital form.

Once the feasibility of the major concepts involved had been properly demonstrated, the program proceeded into the prototype development phase.

## **THE 300 HZ MODEL DMTR**

The same inexpensive recorder that had been used in the feasibility study was again modified in order to demonstrate the great utility and superior capabilities of the DMTR. Special, yet inexpensive, multitrack heads were installed and the tape speed was doubled. This prototype provided six simultaneous data channels and the unmodulated reference track needed for digital playback. This reference track could be converted to a data track if no digital outputs were desired. Each data channel had a bandwidth of 300 Hz (-3 dB point); 45 minutes of continuous data could be collected on a reel of 1/4-in.-wide audio tape costing \$2.40.

No PLL was built for this first prototype. The PLL was used only to retrieve data in digital form. Since this capability was demonstrated previously in the feasibility model, and because a second prototype was planned, this omission was made.

## THE MODEL 300 PROTOTYPE

A second prototype was then built to demonstrate full performance capabilities. Designated Model 300, this prototype provides a bandwidth of 2500 Hz which is believed to be sufficient for most Navy applications. Six channels provide simultaneous digital data when used with the reference channel and PLL (both also provided). A switchable analog demodulator can be used to look at any data channel during either recording or playback. This final prototype was thoroughly characterized by using both the analog demodulator and a CDC 6700 digital computer. The evaluation showed that the initial premises and objectives had been realized. It is estimated that Model 300 can be duplicated in limited production for around \$5000 each (1971 dollars). Large quantity production can greatly reduce the price per unit. A detailed description of Model 300 and its subsystems is given later in this report, followed by an evaluation of its performance.

Because of the high promise demonstrated by the tape recorder, application has been made for a patent on its operation (Navy Case 50,526 filed 20 April 1971).

## DIFFERENTIAL PULSE WIDTH MODULATION (DPWM)

Because of the lack of low-frequency response of the magnetic tape recording process itself, some form of modulation scheme must be employed in any tape recording system where d.c. or quasi-steady-state response is required. Techniques employed to overcome this drawback usually fall into one of two groups. One encompasses the analog-to-digital conversion, digital-record schemes such as pulse code modulation (PCM). For instance, analog data are sampled, converted into a series of binary coded decimal (BCD) representations, and recorded on the tape. However, the PCM signal alone may not satisfy the requirements for recording directly. In such cases, the PCM is used to modulate a carrier in some fashion such as amplitude modulation (AM) or frequency modulation (FM).

If this is the case, the resultant signal falls into the second group. It includes carrier modulation techniques such as AM, FM, pulse amplitude modulation (PAM), pulse width modulation (PWM), phase modulation (PM) and pulse position modulation (PPM). Differential pulse width modulation (DPWM) and differential pulse position modulation (DPPM) are each special cases of PWM and PPM, respectively. They are interrelated in that DPPM represents the first derivative of DPWM. Both forms appear in the DMTR circuitry.

## DPWM ARCHITECTURE

Figure 1 shows a DPWM signal; note the unmodulated signal (carrier) indicated in Figure 1a. The carrier is of square waveform with constant amplitude equal to  $A$  and constant period equal to  $1/f_c$ . The frequency  $f_c$  is also referred to as the sampling rate since each cycle also represents a datum sample. The unmodulated carrier has a duty cycle of one-half or a 50 percent symmetry, i.e., the signal is positive one-half of the time. Figures 1b and 1c show that modulation upsets this symmetry. Positive modulation causes a symmetry greater than 50 percent and negative modulation a symmetry less than 50 percent. Note that the amplitude, frequency, and phase of the DPWM signal remain unchanged; only the symmetry is affected.\*

Figure 2 demonstrates how information is stored in a DPWM signal. One cycle is shown with its positive transition referenced to  $t = 0$ . The dashed lines represent arbitrary modulation limits. These limits correspond to 25 and 75 percent symmetries. The modulating signal, designated  $v_m$  causes the switchover time  $t_s$  to change according to the equation  $t_s = \pi(1 + v_m/2)$ . Thus for  $v_m = -1$ , the switchover time will be  $\pi/2$ , and similarly for  $v_m = 1$   $t_s = 3\pi/2$ . If the data conform to the restrictions of modern modulation practices, then no data frequency will be greater than 20 percent of the carrier frequency. Thus the DPWM signal can be separated with a low-pass filter, and the carrier fundamental and its higher harmonics eliminated. This amounts to setting all terms of the Fourier series expansion of the DPWM signal to zero except for the constant  $a_o$ , the d-c term. This term represents the stored data and can be computed from the equation for the Fourier coefficients as follows:

$$a_o = \frac{1}{2\pi} \int_0^{2\pi} f(t) dt \quad f(t) = \begin{cases} 2, & 0 < t < t_s \\ -2, & t_s < t < 2\pi \end{cases} \quad [1]$$

$$t_s = \pi \left( 1 + \frac{v_m}{2} \right)$$

$$a_o = \frac{1}{2\pi} \int_0^{t_s} (2) dt + \frac{1}{2\pi} \int_{t_s}^{2\pi} (-2) dt \quad [2]$$

$$= \frac{2}{2\pi} \left[ t \right]_0^{\pi \left( 1 + \frac{v_m}{2} \right)} + \frac{2}{2\pi} \left[ -t \right]_{\pi \left( 1 + \frac{v_m}{2} \right)}^{2\pi}$$

$$= \frac{1}{\pi} \left[ \pi \left( 1 + \frac{v_m}{2} \right) \right] - \frac{1}{\pi} \left[ 2\pi - \pi \left( 1 + \frac{v_m}{2} \right) \right]$$

$$a_o = v_m \quad [3]$$

---

\* As will be seen later, this is so only for true d-c modulating signals. For varying modulating waveforms (sine waves, triangular waves, etc.), the frequency is also somewhat changed in accordance with the dynamic properties of the modulating signal.

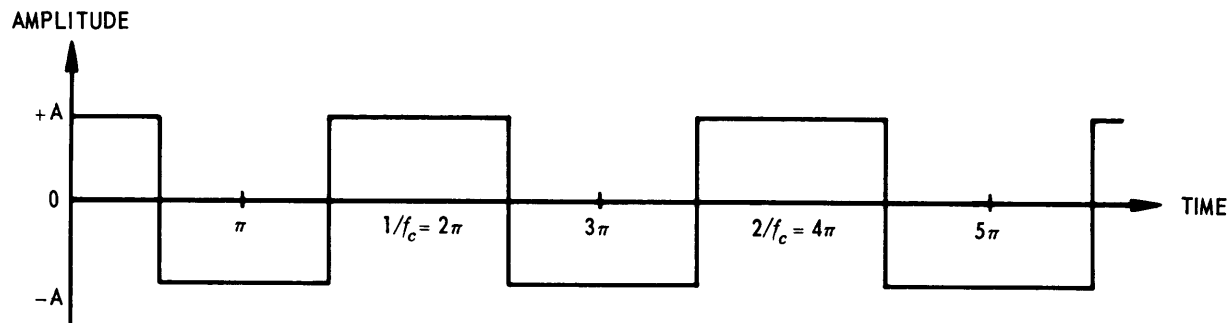

Figure 1a – Unmodulated

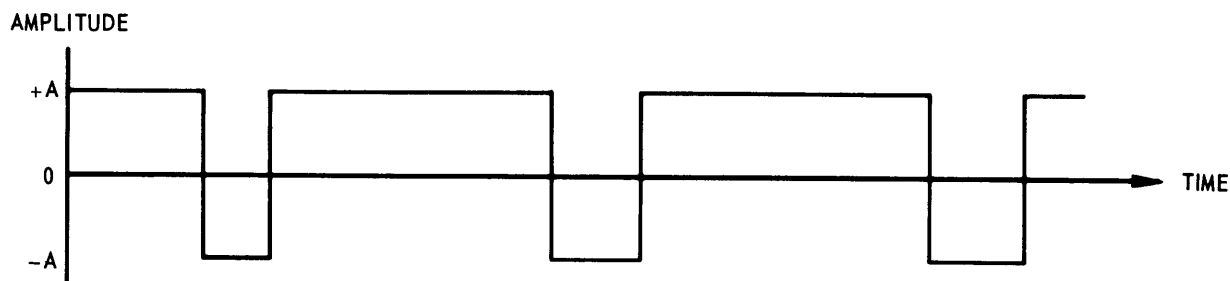

Figure 1b – Positively Modulated

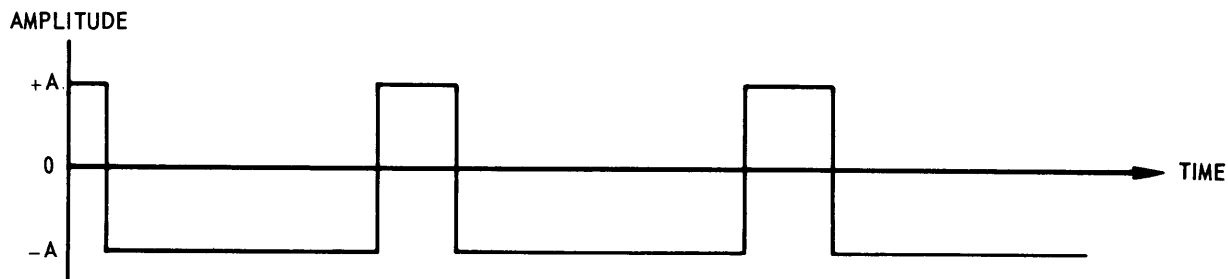

Figure 1c – Negatively Modulated

Figure 1 – Differential Pulse Width Modulation

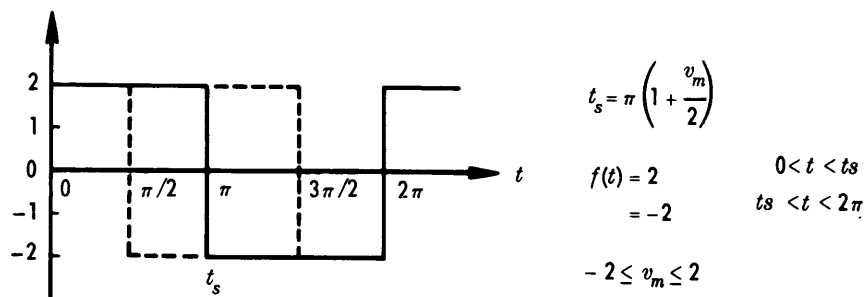

Figure 2 – Typical Data Storage in Differential Pulse Width Modulation



Thus the data value (the value of  $v_m$ ) is contained in the average value  $a_o$  of the DPWM signal and can be extracted with a low-pass filter. The amplitude of  $\pm 2$  was chosen as a convenience to force the coefficient of  $v_m$  to equal 1. Changing this amplitude is obviously a convenient method of scaling the demodulated signal to any desired value.

## PWM AND DPWM DISSIMILARITY

Conventional PWM and a circuit technique for generating it are displayed graphically in Figure 3. It can be seen from Figure 3d that the modulating voltage  $v_m$  is compared to a reference voltage  $v_c$  in an amplifier which has a gain on the order of 100,000. Whenever  $v_m$  becomes more positive than  $v_c$ , the amplifier output goes positive and vice versa. The zener diodes are used to clamp the output to convenient positive and negative limits. The resultant PWM is illustrated in Figures 3b and 3c. The leading edge of each pulse coincides with the return of the reference voltage to its most negative value. The reference increases in value until coincidence occurs with the data. At this point the pulse ends. The width of the pulse is representative of the data value. Note that only leading edges are periodic, i.e., occur at equal time intervals  $2\pi, 4\pi, 6\pi$ , etc. The pulses themselves are not periodic. The centers of energy of the pulses move as a function of the modulating voltage, thus generating harmonic distortion. In addition this causes intermodulation distortion of multifrequency waveforms. Similar distortions occur in FM and PM formats.

Unlike these other formats DPWM is substantially free from these distortions. DPWM replaces the reference voltage sawtooth of Figure 3 with the symmetrical triangle wave of Figure 4. Note that the periodicity of the DPWM remains constant and is fixed by the period of the triangle regardless of data amplitude. Thus no intermodulation products are generated.\* In addition the sampling time base is permanently established so that later recording and reproducing at differing time bases do not affect the established sampling properties. A precision triangular voltage wave is required. The positive and negative slopes of the waveforms must be precisely equal and the zero line must be exactly in the center. In other words, the waveform must exhibit precise symmetry of both time and amplitude so that any symmetry unbalance in the DPWM waveform will be solely the result of the data signal.

## CONSIDERATIONS OF TIME-VARYING DATA

To this point, the modulating voltage  $v_m$  has been considered to have only steady-state characteristics. That is, only d-c voltages have been considered. However, dynamic data must be accommodated in order for the technique to have any usefulness. A good rule of thumb, and one which is observed here, is that the ratio of the sampling frequency to the

---

\*Again this is strictly true only for modulating signal frequencies which are much lower than the carrier frequency.

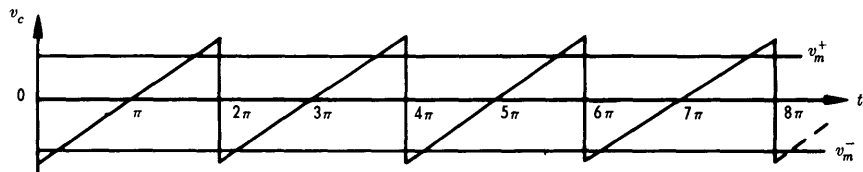

Figure 3a – Reference Voltage  $v_c$

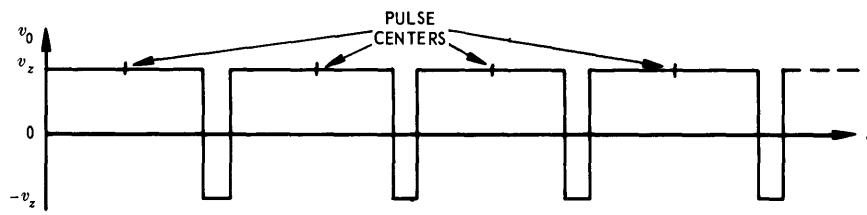

Figure 3b – Positive Modulation

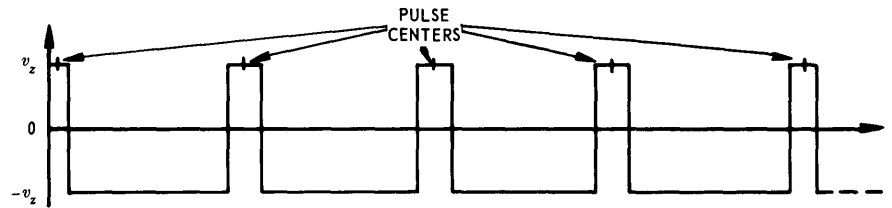

Figure 3c – Negative Modulation

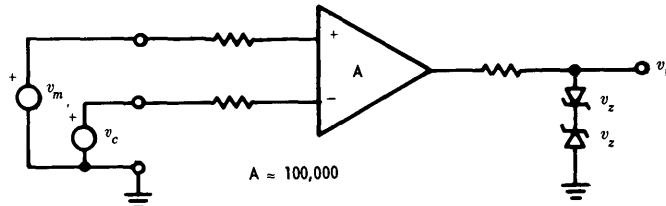

Figure 3d – Typical Circuitry for Generating Pulse Width Modulation

Figure 3 – Conventional Pulse Width Modulation

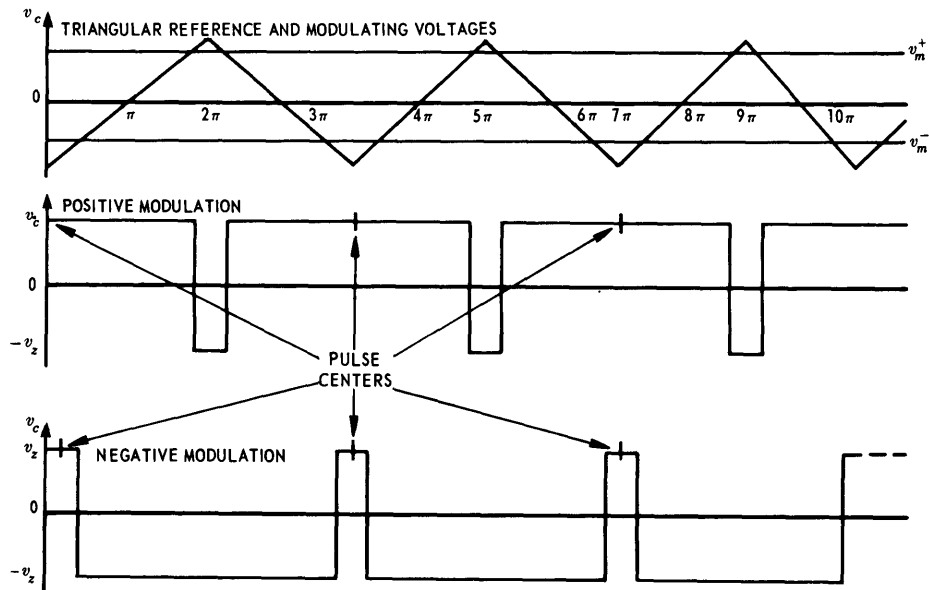

Figure 4 – Differential Pulse Width Modulation Waveforms

data frequency must be no less than 5. Thus, for data of frequencies up to 100 Hz, a triangle frequency of no less than 500 Hz should be used. This permits the use of a physically realizable low-pass filter for demodulation.

Two primary methods of demodulation are discussed later in this report. The more straightforward method is demodulation into the original analog form. If a properly designed low-pass filter is used, no significant errors are introduced as a result of the dynamic characteristics of the data. Only the ordinary amplitude and delay characteristics of the filter are introduced. Again, if the filter is properly designed, these effects are acceptable.

Digital demodulation is a more complex process and involves the use of a digital computer. This demodulation technique offers the preciseness of a time base which is fixed upon recording, a useful asset when spectral analyses are performed. The slight errors introduced during modulation of dynamic signals can be diminished mathematically to obtain the desired results.

The nature of the DPWM signal is mathematically explored in detail in Appendix A which treats both the analog and digital demodulation schemes. The errors involved in digital demodulation are explored for a ramp function input, and estimates are made for the worst case error.

## ADVANTAGES OF THE DPWM FORMAT FOR TAPE RECORDING

The use of DPWM in tape recording overcomes the effects of wow and flutter which so severely hamper formats such as FM. In FM demodulation, the recovered frequency is converted directly and proportionally into a corresponding amplitude or voltage. Tape speed variations (wow and flutter) adversely affect this recovery. The wow and flutter causes frequency changes, and is demodulated just as though it were data. Therefore, an amplitude error is incurred as well as the causative time error.

As already shown in discussing the basic concept (and treated in more detail in Appendix A), the signal recovered from a DPWM modulation scheme is independent (amplitude-wise) of the exact carrier frequency. If the demodulation circuitry is carefully designed, speed variations of  $\pm 50$  percent can be tolerated without significant degrading of signal amplitude. Although the time base information will be degraded during analog demodulation, this time error is seldom important except in the most exacting work. The amplitude accuracy given by DPWM is usually of far greater importance.

The time base change can be corrected by demodulating digitally. The DPWM signal is generated by a precision triangular wave generator. The DPWM time base is set by this triangular wave generator, and is therefore established during the modulation process. Accordingly, the time base can be easily reestablished in the computer during digital demodulation. The amplitude and time base accuracies are faithfully preserved, and there is no need for expensive and bulky tape-handling equipment for the time base control. Thus the application of the DPWM format to tape recording produces at once improved data accuracies and drastic reductions in equipment cost.

## A SYSTEM VIEW OF THE DMTR CONCEPT

A complete digital magnetic tape recording system is comprised of six main subsystems: (1) precision triangular wave generator, (2) recording circuitry, (3) tape deck, (4) reproduce circuitry, (5) analog demodulator, and (6) digital demodulator. Separate record and reproduce circuits must be provided for each channel to be recorded. In addition a reference channel must also be provided for some digital demodulation techniques. This is usually done simply by shorting the input to one data channel. Several variations in technique are possible at the demodulation stage. Subsystems (5) and (6), therefore, are really a multiplicity of different interchangeable circuits, all designed to do the same job in slightly different ways.

The general block diagram of a DMTR system depicted in Figure 5 is a typical scheme; many variations are possible. For instance separate demodulators could be provided for each channel to permit simultaneous playback of all channels.

A separate tape track must be provided for each of the  $n$  channels. In general, then, a multitrack recorder must be used whose number of tracks is at least as great as the number of channels (including the reference channel) to be recorded.

The triangular wave generator provides both amplitude and time references for the tape recorder. It is therefore imperative that this generator be designed to provide a triangular wave of high precision and stability. The data are compared to the triangular wave by the record circuitry. Maximum overall accuracy is established at this point. This fact emphasizes the need for a precision triangular wave, i.e., one which is stable in amplitude, possesses excellent linearity, has two identical slope magnitudes (different only in sign), is free of noise, and has stable frequency. The data-triangular wave comparisons yield the desired DPWM pulse train. This signal is properly conditioned and supplied to the tape deck by the record circuit.

The tape deck enables the storage of data. Record and reproduce heads are provided together with a mechanism for moving the recording tape past these heads at a relatively constant rate. The conditioned DPWM signal is applied by the record head with no bias. The recorded signal is recovered by the reproduce head in differential pulse position modulation (DPPM) form because of the differentiation attending the reproduce process. This small recovered signal is given the necessary amplification in the reproduce circuitry, where it is also reconverted into the DPWM form and sent on, ready for demodulation.

Several interchangeable options are available for demodulation circuitry. The digital demodulation technique described herein is of revolutionary importance because it permits data reduction directly by a digital computer. Other options include low-pass filters of either constant-amplitude or constant-delay types and a differential staggered incremental demodulator or similar device.

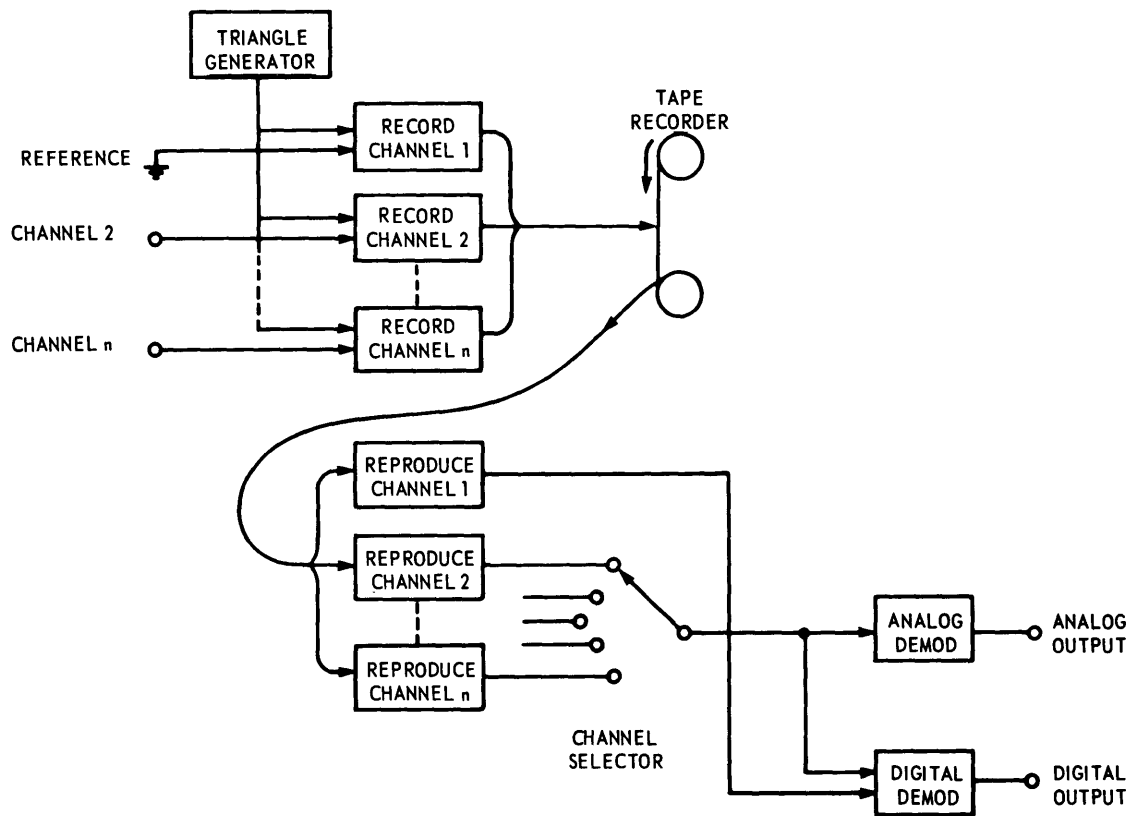

Figure 5 – Typical Digital Magnetic Tape Recorder Scheme

## DATA ACQUISITION AND REPRODUCTION FUNCTION

The typical data acquisition and reproduction function on the DMTR consists of three processes: the recording process, the reproduce process, and the demodulation process.

### Recording Process

The recording process proceeds from the ingestion of the data signal to the application of the data to the tape in DPWM form. The triangular wave generator and the record and tape deck subsystems are employed. A simplified schematic is shown in Figure 6.

The comparator performs the actual process of modulation. Its output assumes one of two states, high or low (best designed to be equal positive and negative voltage), depending on the instantaneous relative amplitudes of the data and triangle. The result is a DPWM signal with fundamental frequency equal to the frequency of the triangular wave. Any ranging (scaling) of the input data is easily handled by changing the relative amplitudes of the data signal and triangular wave before the comparison is made. For instance, a 10-to-1 change in the triangular wave amplitude will cause a 10-to-1 change in the sensitivity of the modulation circuit.

The DPWM signal appearing at the output of the comparator is further amplified and conditioned by the record amplifier before it is applied to the record head. Basically the desired result is to alternately saturate the magnetic tape positively and negatively in accordance with the DPWM signal. Some preemphasis is applied in order to improve the switching time between the positive and negative saturation states. This overcomes the inductance of the record head and permits the required fast switching of the record current.

Note the utter simplicity of the modulation and recording processes. The frequency-sensitive and nonlinear elements usually required for the modulation process are absent here.

The tape and head characteristics play an important part in ensuring a quality recording. High packing densities are typically encountered in recording DPWM (1000-1500 bits per inch), and good characteristics of both head and tape are essential. None of the tapes investigated in this program surpassed the 3M Company 290 audio recording tape, not even the tapes expressly made for digital work. This paradox is attributed to the fact that the nature of DPWM is pseudodigital. The symmetry changes in an analog manner. The ability to measure this symmetry is related to the resolution of the tape. Although digital tape is of good quality (i.e., has few dropouts, etc.) and its saturation levels are quite high, its resolution is not as good as with the analog tape. In digital work signals are always applied at a constant rate, say, 500 or 800 bpi. The tendency for adjacent positive and negative pulses to (slightly) erase one another is not important or even apparent. However, this effect becomes quite significant in DPWM when a positive-going edge and a negative-going edge approach each other. This effect is extremely undesirable. Only tape of first quality with a very thin, homogenous oxide coating (and therefore high resolution) is acceptable.

Another parameter which affects performance is the "slew rate" of the magnetic coating, i.e., the rate at which the particles can change from one saturation state to the other. Experience has shown that this factor is also influenced by the thickness of the oxide coating and by the type of oxide used.

Recording head quality is at least as important as tape quality. Inductance must be kept low in order to achieve high frequency performance. This means as few turns as possible in the head winding, because the record head flux density is proportional to the product of the number of turns and the head current, with few turns the high flux density required must be generated with high currents. The record head must be capable of handling these currents.

Crosstalk in the record head must be kept to a minimum because of the large flux densities which are generated. This problem has been a source of minor irritation on this program because of the initial choice of a high density head (28 tracks per inch). The situation is easily correctable for future recorders by using either a head with fewer tracks (and hence fewer data channels) or a head with better crosstalk characteristics.

### **Reproduce Process**

Reproducing the DPWM signal involves the tape deck and reproduce circuitry subsystems. The recorded signal is recovered in DPPM (differential pulse position modulation) form due to the differentiation of the DPWM signal which occurs in the reproduce head. A positive pulse is recovered for each positive-going DPWM excursion and a negative pulse for each negative-going excursion similar to that presented in Figure 7 which shows the recovered signal after amplification along with the noise which might be expected. The recovered pulse width is a function of the factors mentioned before, i.e., slew rate and resolution of the tape oxide coating, time constant of the record head, amount of pre-emphasis applied, etc. It is also a function of the time constant of the reproduce head circuits and the bandwidth of the reproduce amplifier. It is most desirable that these pulses be as narrow as possible and that they have very small rise times.

**High Gain Reproduce Amplifier.** The reproduced signal must be amplified. The bandwidth of the amplifier should be as wide as is consistent with the high amplification required. The amplified signal is sent to a comparator for reconstruction into DPWM. The comparator has some hysteresis; i.e., instead of comparing the input signal to a fixed level such as 0 V, a portion of the output is returned as positive feedback to the input and used as the threshold of comparison. The output of the comparator can assume one of two stable levels depending on the relative levels of the inputs. A positive-going pulse causes the output to change state to, say, +10 V. Part of this is fed back to the input to establish the lower comparison level as shown in Figure 7. This level must be overcome by the input in order to cause the output to change to its negative state. For instance, if one of the 10 volts at the output is fed back, the input must go below -1 V to overcome the hysteresis and cause a

state change. This is accomplished by a negative-going pulse whose the amplitude must obviously go more negative than the  $-1$  V hysteresis level. The same effect occurs for the opposite polarity case.

To avoid false triggering, the hysteresis levels are carefully set to be less than the peak pulse level yet greater than the attendant noise. If the comparison levels are properly set, the resultant output is a reproduction of the original DPWM signal recorded.

Some noise in the form of "jitter" of the switching times is also produced. The noise arises from several sources. Some "jitter" is present in the original recorded signal because of the noise of the record circuitry, but this is very small if the circuitry has been properly designed. Noise generated by the playback amplifier is slightly more serious because of the large amplification required. However, the selection of quality amplifiers and the proper design can minimize the noise from this source also. Dirty record and playback heads and tape guides cause excess flutter and vibration of the tape which causes noise. The proper maintenance of the tape handling equipment will minimize this problem.

The greatest source of noise, however, is the tape itself. Noise is caused in two ways. Some residual noise is present even on virgin magnetic tape. This is random noise of generally low magnitude caused by the random magnetization of the particles on the unrecorded tape. The second source is the sensitivity inconsistency of the magnetic oxide surface. This coupled with the varying head-to-tape contact causes pulses of varying amplitude to be recovered, even though the record signal remains a constant. Thus a range of pulse amplitudes may be recovered. Figure 8 depicts a typical range of amplitudes which might be encountered for a particular pulse.

Notice in Figure 8 that the comparison level must be set low enough to be intersected by pulse  $p_3$  yet high enough to avoid being affected by the residual noise. The times of intersection are different for the pulses. This uncertainty in the time of intersection is the cause of "jitter." As the comparison level is lowered, these times ( $t_1$ ,  $t_2$ , and  $t_3$ ) come closer together and the magnitude of the "jitter" decreases. Thus the content of the noise in the reproduced signal is likewise decreased. It is easily seen that the comparison level should be made as low as possible but not so low that false comparisons are made from the noise. Also a good tape with a homogeneous oxide should be utilized so that the reproduced pulses are as nearly uniform as possible.

A further deduction to be made from Figure 8 is that the narrower the pulse (and thus the shorter the rise time), the less the differences between  $t_1$ ,  $t_2$ , and  $t_3$ . Ideally, vertical leading edges are desired; physically, they are impossible to attain. This is part of the tradeoff to be made in the reproduce amplifier.

**Missed Pulses.** Suppose that pulse  $p_3$  of Figure 8 is not as large (in amplitude) as shown and that it fails to intersect the upper comparison level. If the amplitude of the negative pulse which preceded  $p_3$  was at least as large as the lower comparison level (LCL)



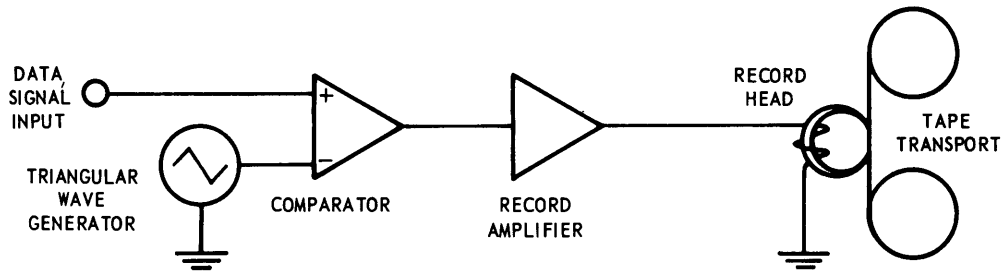

Figure 6 – Details of Record Process

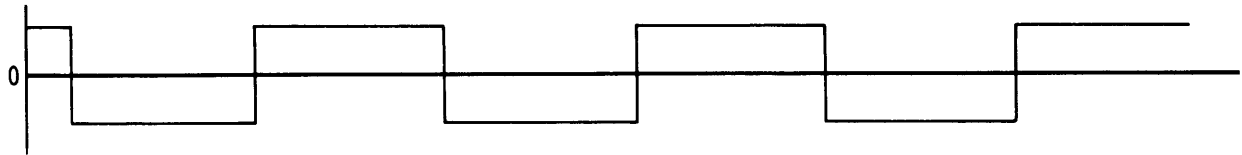

Figure 7a – Recorded Differential Pulse Width Modulation Signal

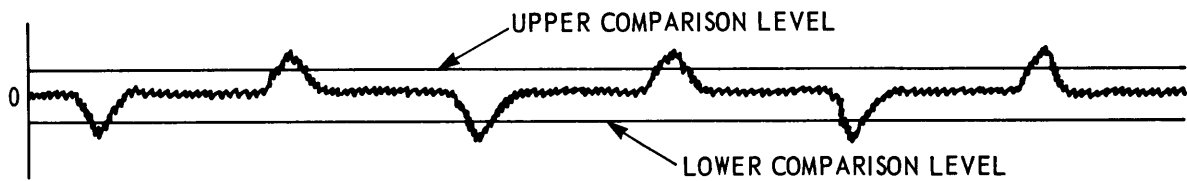

Figure 7b – Recovered Differential Pulse Width Modulation Signal

Figure 7 – Recorded and Reproduced Digital Magnetic Tape Recorder Signals

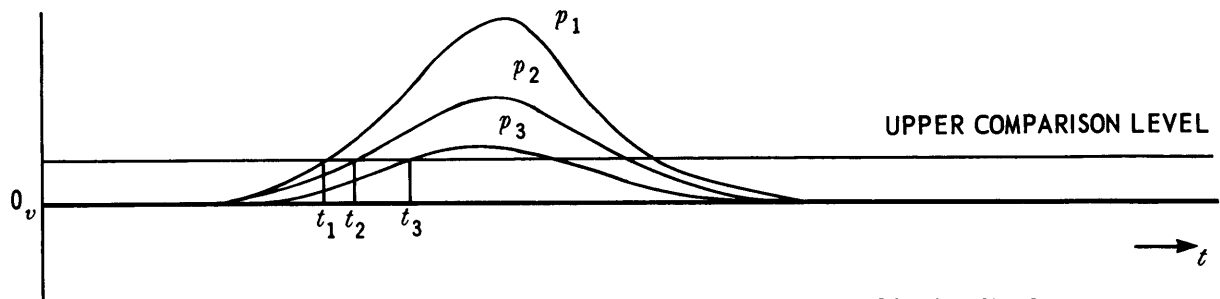

Figure 8 – Typical Reproduced Pulse of Various Possible Amplitudes

that pulse has left the comparator output in the low state.  $p_3$  fails to change the state of the comparator. The negative pulse which follows  $p_3$  does nothing even though its amplitude is greater than the LCL because a positive pulse is required to switch the output to the high state. In effect a whole DPWM sample is missed, and the result is a DPWM pulse which is twice or more as large as it should be. Also note that pulses are *always* missed in pairs. This inherent feature prevents the phase reversal of the output that would occur if only a single pulse (or an odd number of pulses) were missed.

The superlong pulse causes different anomalies depending on how the DPWM signal is demodulated. As expected, the analog filter demodulates these into positive or negative spikes (depending on whether a negative or positive pulse was missed first) similar to the common "discriminator spikes" of the FM format. The spikes may be difficult to distinguish from data. If a type of sample and hold demodulator is used, missed pulses also create spikes. These are easier to detect as anomalies, however, since the missed pulse creates a sample which is "out of range." This is generally easier to handle than with the filter. Digital demodulation techniques create a different problem. Instead of appearing as spikes, the missed samples are "dropped" from the data. In each case of one or more missed pulses, the only sample retained is the last data value before a pulse is finally received. In this technique, the detection of missing data becomes the problem. However, this can be done by synchronizing the computer clock with the reference channel so that the absence of data can be detected and flagged. These concepts are described in greater detail later in the text (see "Digital Demodulation").

**Effect of Residual Record Head Magnetization.** The record amplifier alternately applies large positive and negative currents to the record head in tempo with the applied DPWM signal. If this current is abruptly removed from the record head, the head will be left with a residual magnetism. The direction of the magnetism will correspond to the polarity of the current at the time the signal is removed. If a recorded tape is then passed by this record head in a reproduce attempt (the tape passes by the record head before reaching the reproduce head because of tape deck geometry), the residual magnetism of the record head adversely biases the recorded tape. Tape sections magnetized in the same polarity as the residual record head magnetism are strengthened; those of opposite polarity are weakened. The net effect is a shift in the position of the polarity reversals on the tape. This shift is unpredictable and depends on the polarity and magnitude of the residual magnetism. Good data tapes can be easily destroyed if played back on a deck with a magnetized head.

Provision for avoiding this condition can be provided. Demagnetization of a head is usually accomplished by subjecting the head to a large alternating magnetic field and slowly reducing the field to zero. In this way, the magnetic materials of the head are cycled in an ever-decreasing hysteresis loop which ends at the origin of the B-H curve; i.e., no residual magnetization remains. The same technique can (and should) be employed by slowly reducing the amplitude of the DPWM signal to the head. This slow removal brings the residual magnetism to zero whereas abrupt removal leaves a large residual magnetism.

## Analog Demodulation

Three techniques have been developed for demodulating DPWM signals. Two of these yield the data in analog form, and the third yields the data in a purely digital form.

**Low-Pass Filter.** Any desired type of low-pass filter can be used to extract the data. The particular type is determined by the characteristics of the output data desired (i.e., constant amplitude, linear phase, etc.). For instance, excellent results can be obtained with a five- or six-pole Butterworth filter with a half-power frequency equal to one-fifth of the DPWM carrier frequency. With a five-pole Butterworth, the carrier is attenuated better than 60 dB, thus permitting a good signal-to-noise ratio. The low-pass analog filter is particularly attractive when good amplitude accuracy is desired. As pointed out in Appendix A, when the positive and negative levels of the DPWM signals are equal in magnitude but opposite in sign, the d-c term of the Fourier series (that term which is extracted with a low-pass filter) is zero for 50-percent symmetry. Furthermore, within the limits of the filter, the term is not a function of carrier frequency, and therefore not affected by tape speed, wow, and flutter.

**Differential Staggered Incremental Demodulator (DSID).** The differential staggered incremental demodulator (DSID) was devised to overcome the phase shift experienced with low-pass filters. The DSID consists of two sample and hold circuits, one circuit for each partial cycle of a DPWM sample (hence the term differential staggered). The width of each partial cycle is converted into a proportional amplitude (incremental), and the amplitude levels are recombined into a staircase replica of the original analog signal (demodulator). The simplified schematic of Figure 9 shows the basic DSID operation.

The DPWM signal is separated by the steering diodes  $D_1$  and  $D_2$  into its positive and negative parts so that the positive half is fed only to the positive integrator  $I^+$  and hold amplifier  $H^+$ . Similarly, the negative half DPWM pulse widths are sent only to  $I^-$  and  $H^-$ . Because of the differential nature of DPWM, each of these positive and negative pulses can be handled separately to yield independent samples. Each of these samples begins as a width, is transformed into an amplitude proportional to that width in the integrator, and sent to a hold amplifier. Positive and negative samples are then recombined arithmetically to form a representation of the original data. This recombination automatically cancels the offsets generated by each integrator. The waveforms of the circuit of Figure 9 are shown in Figure 10. The necessary control pulses which are generated by one-shots A and B are not depicted.

Briefly the circuit operation is as follows.  $D_1$  clips the DPWM signal and forms a train of positive pulses with varying widths. These pulses are integrated in  $I^+$  at a constant rate. The result is a voltage proportional to the pulse width as shown in Figure 10e. During the period just following the pulse integration when the output of the  $I^+$  integrator is constant,

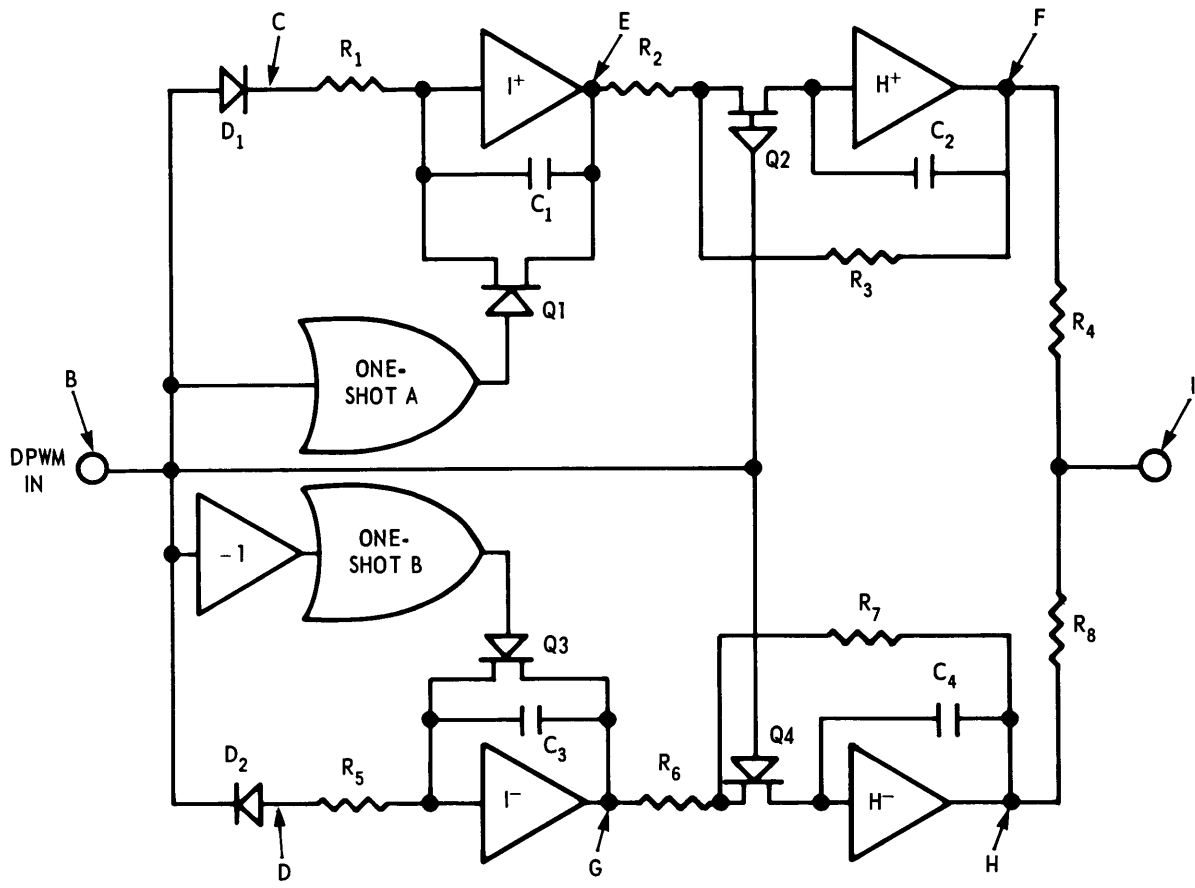

Figure 9 – Basic Operation of the Differential Staggered Incremental Demodulator

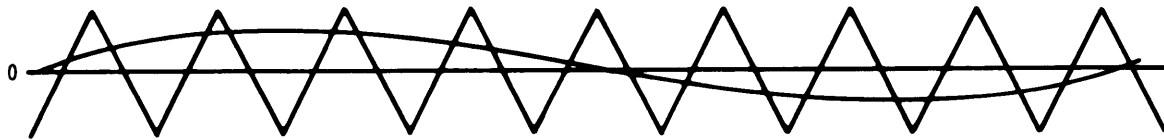

Figure 10a – Data and Triangular Modulator

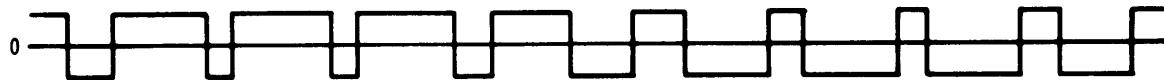

Figure 10b – DPWM Representation



Figure 10c – Positive Half-Samples

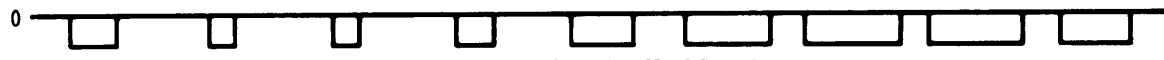

Figure 10d – Negative Half-Samples



Figure 10e – Integration of Positive Pulses (Output of Integrator  $I^+$ )

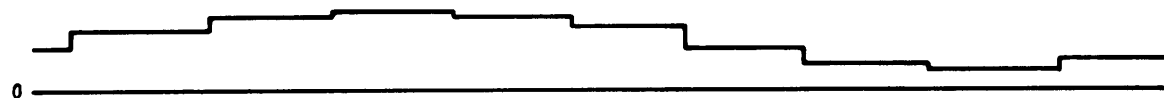

Figure 10f – Output of Positive Hold Amplifier  $H^+$

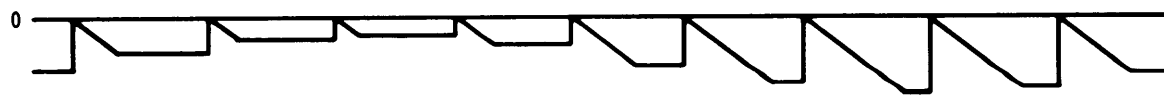

Figure 10g – Integration at Negative Pulses (Output of Integrator  $I^-$ )

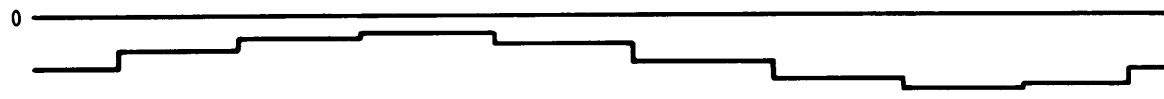

Figure 10h – Output of Negative Hold Amplifier  $H^-$

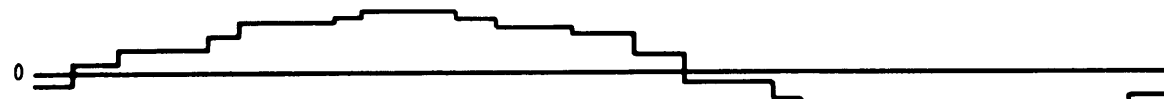

Figure 10i – Resultant Demodulated Output

Figure 10 – Waveforms of the Differential Staggered Incremental Demodulator

the hold amplifier operates as a unity gain amplifier because FET Q2 is turned on. At the end of this period Q2 is turned off, converting  $H^+$  to the hold mode. At the same time, FET Q1 is briefly turned on by a short pulse from one-shot A. This resets the integrating capacitor  $C_1$  to zero, and a new integration cycle begins on the next pulse. A similar process occurs in the other half of the DSID. Here, however, the direction of integration is reversed. This is necessary since for positively increasing data the positive pulses increase and the negative pulses decrease. The positive integrator yields increasingly positive levels, and the negative integrator yields decreasingly negative levels. The result is the same. After the summation through  $R_4$  and  $R_8$  the offsets are cancelled and the result shown in Figure 10 is obtained.

The steps can easily be removed with a low-pass filter. However, this detracts from the major advantage of the DSID. The demodulator delay is limited to a half-cycle of the carrier frequency, and a low-pass filter only adds further delay. Paradoxically, although the steps appear to detract from the waveform, they do in fact contain as much information as does the DPWM signal itself.

### Digital Demodulation

The overwhelming advantage of the Digital Magnetic Tape Recorder and the DPWM format is the capability for direct demodulation in a digital form with high precision. The two related techniques developed to produce this result will be discussed in connection with their use with the prototype recorder (Model 300). Basic to both techniques is the generation of a reference (or "sprocket") frequency which is a large multiple of the DPWM sampling frequency. This reference frequency is then used to measure the widths of the DPWM pulses by gating and counting.

**Phase-Locked Loop (PLL).** Although PLL has been known and understood for many years, the complicated and expensive circuitry involved precluded practical application until recently when integrated circuits became available for fabrication purposes. The PLL is an electronic servo system whose properties can be utilized to multiply a varying frequency by a constant. The circuitry assumes the normal servo system format, beginning with a phase comparator which compares the phase of the system input with a feedback signal which is a facsimile of the output. Any phase error is converted to a voltage and used to control a voltage-controlled oscillator (VCO) which generates the output frequency. If it is desired that this frequency be a multiple of the system input frequency, the output is divided by the multiplication factor and returned to the phase comparator as mentioned above. This closes the loop. The output frequency in such a system is a multiple of the input frequency and "tracks" it.

This principle is used to great advantage in the DMTR. One track of the tape is used to record an unmodulated DPWM carrier. When played back, the frequency of this signal changes in proportion to the combined wow and flutter effects encountered during the

recording and playback processes. The signal is then applied to the input of a PLL with, for example, a multiplication factor of 200. Provided the frequency of the wow and flutter components are significantly lower than the frequency of the DPWM carrier, the multiplied frequency at the output of the PLL also exhibits frequency modulation as a result of wow and flutter. The effect is to generate a fixed number of pulses (in this case, 200) for each DPWM cycle regardless of the record and playback speed or the induced wow and flutter.

By virtue of the fixed tape relationship between the reference track and the data tracks, the signals of reproduced data (in DPWM form) share the same wow and flutter modulation as the reference. Therefore in order to recover the stored data, it is only necessary to gate the multiplied reference ("sprocket") by the datum DPWM sample. Because the total length of a DPWM sample is equivalent to 200 "sprocket" pulses, if the gating signal is made to be the positive half of the datum signal, a pulse with 50-percent symmetry (unmodulated DPWM signal) will yield a pulse burst of 100 pulses. Positive modulation (> 50-percent symmetry) will yield more pulses, and negative modulation (< 50-percent symmetry) will yield fewer. The pulses need simply be counted, say in a computer, to determine the data values. In effect, the system is an electronic variable scale because a ratio of 200 pulses per DPWM cycle is established, wow and flutter and changes in tape speed notwithstanding! This fact permits very inexpensive tape-handling equipment to be used and thus greatly reduces recorder costs. A block diagram of the type of system discussed above is presented in Figure 11.

Notice that one element of the PLL is a filter. Because the other elements of the loop are integrated circuits their transfer functions are usually fixed. The filter is of custom design in order to produce the desired loop response. The filter must reject all of the DPWM carrier frequency yet pass the frequencies of tape flutter. As tape moves past the magnetic heads the vibration generated can often be of high enough frequency to be significantly close to the DPWM frequency. When this is the case, the necessary filter design becomes critical or even impossible. Then a compromise must be made or the PLL abandoned in favor of another technique.

$\frac{A}{A+B}$  **Ratio Correction for Flutter.** The data stored in the DPWM signal are present

as much in the negative portion of the waveform as in the positive portion. It should be obvious then, that the data can be expressed as the ratio of the positive portion to the whole. If the positive portion pulse width is called  $A$  and the negative portion pulse width  $B$ , then the desired ratio is  $\frac{A}{A+B}$ . The ratio holds perfectly if the flutter frequencies are low enough so that pulse widths  $A$  and  $B$  are equally affected. It is much easier to achieve this condition than to design the necessary filter for the PLL. To use the  $\frac{A}{A+B}$  ratio correction both pulse widths  $A$  and  $B$  must be measured. This can be achieved by simply inverting the DPWM signal and repeating the gating process to obtain the value of  $B$ . The necessary computations are then done in the computer as before. For the 200 pulse/cycle example and a DPWM symmetry of 50 percent, the computations might look as follows:

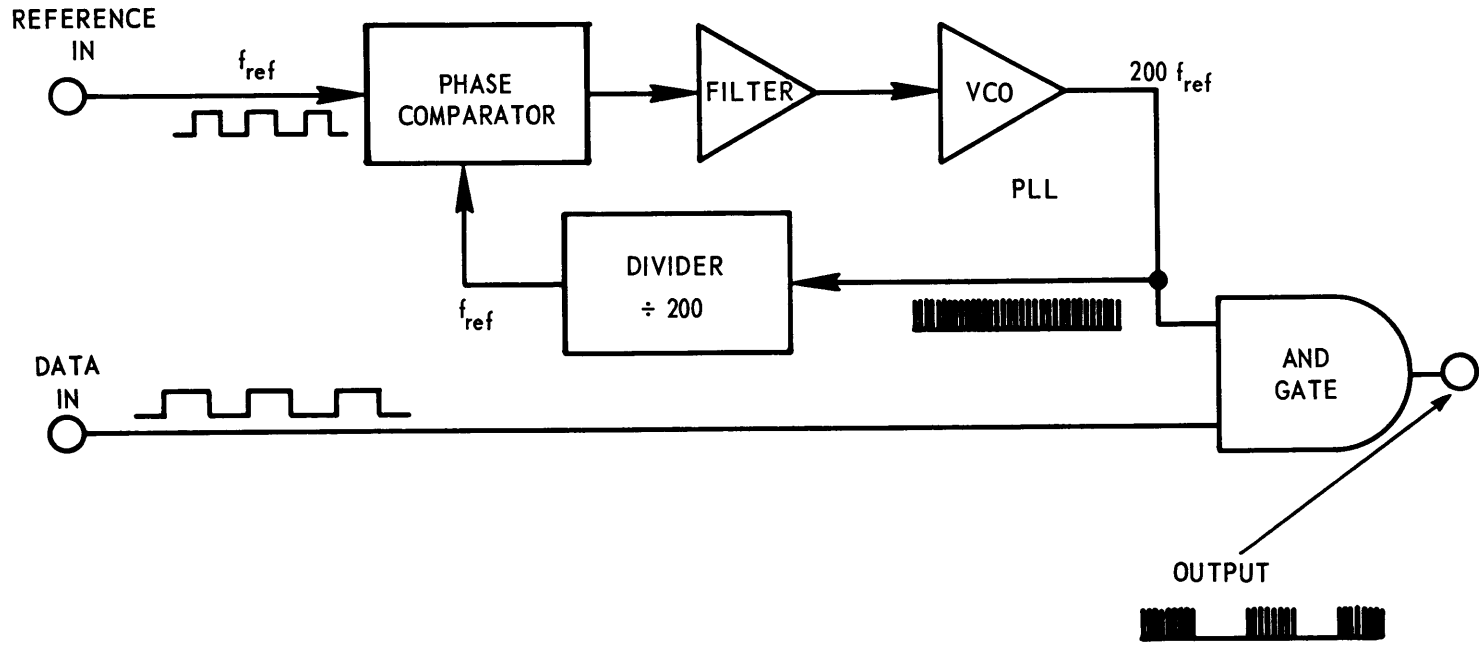

Figure 11 – Typical Digital Demodulation Using a Phase-Locked Loop



$$A = 100$$

$$B = 100$$

$$\frac{A}{A + B} = \frac{100}{100 + 100} = 0.5$$

Suppose now that there is a 10-percent decrease in tape speed that is not corrected by the PLL. Then

$$A = 100 + 0.10 (100) = 110$$

$$B = 100 + 0.10 (100) = 110$$

$$\frac{A}{A + B} = \frac{110}{110 + 110} = 0.5, \text{ the same result.}$$

Scaling can now be applied to return the result to the desired base of 200:

$$200 \frac{A}{A + B} = \frac{(200) (110)}{110 + 110} = 100$$

which is equivalent to a datum value of zero. Zero suppression can also be achieved by subtracting the residual value equivalent to zero, 100. The entire computation is now

$$x = \frac{200 A}{A + B} - 100$$

As a further example, assume a DPWM symmetry of 75 percent equivalent to a datum value of 50. Further assume an uncorrected speed increase of 15 percent between recording and playback (this is an extreme value for uncorrected tape-speed-induced error):

$$A = 150 - 0.15 (150) = 127.5$$

$$B = 50 - 0.15 (50) = 42.5$$

Because half a pulse cannot be counted, these values are rounded off by the counters to  $A = 127$  and  $B = 42$ . The computer computations are now:

$$\begin{aligned} x &= 200 \frac{A}{A + B} - 100 \\ &= \frac{(200) (127)}{127 + 42} - 100 = \frac{25400}{169} - 100 \\ &= 150.3 - 100 \\ x &= 50.3 \end{aligned}$$

The residual error is much less than would be achieved directly with a 15-percent change in tape speed.

**Missing Pulses.** The easiest method of generating the numbers  $A$  and  $B$  is to electronically count the pulses in the gated pulse burst (the OUTPUT of Figure 11). But what happens when on playback a pulse is missed as discussed previously? As noted then, a single pulse can never be missed—only pulse pairs. A tremendous advantage is gained if the multiplication factor of the PLL is set to be a power to two, say 512, and the counter used to count the pulse bursts also has this capacity but no more. If a pulse pair is missed under these conditions the long DPWM cycle which results has minimal effect because after 512 counts, the counter automatically resets to zero (the counter overflows out of capacity). For instance, suppose a negative pulse is missed; as a result, the next positive pulse is ignored. Thus the value for  $A$  is very large, so large in fact that it is the summation of  $A + B$  of the missed cycle plus the  $A$  value of the next cycle, or approximately  $2A + B$ . But  $A + B = 512$  and  $A + B + 1 = 0$ . Therefore, the counter resets after the appropriate elapsed time for  $A + B$  of the missed cycle. The counter continues counting the next  $A$  value which it counts as  $2A + B - (A + B + 1) = A - 1$ . The result is off by only one count in 512 and the sample missed is completely ignored! Of course the result can be extended to more than one missed pulse pair.

**Free-Running Oscillator.** If the user is willing to double his effort and measure the values of both pulse widths  $A$  and  $B$  in order to calculate the ratio  $\frac{A}{A + B}$ , it is not always necessary to use the PLL at all. Provided the changes in tape speed are not too severe the mathematical correction by the computer is quite satisfactory. Accordingly, the sum of the number of pulses counted for  $A$  and  $B$  will be relatively constant and permit sufficient precision and resolution for the measurements to remain consistent. In this situation, the PLL can be replaced by a stable free-running oscillator. Both techniques have been investigated, and the results are documented in the section on Model 300 evaluation.

### Computer Interface Techniques

The ideal method of digitally reducing DMTR data is to have a DMTR reproduce unit as an on-line computer peripheral. For the investigative program which was conducted such elaboration was well beyond the limited scope permitted. However, such a capability should be an ultimate goal in further development programs.

There were two obvious alternative methods. First, playback of the data in analog form with subsequent analog-to-digital conversion on the SDS 910 at NSRDC could have produced the required digital format. However this technique does not utilize nor evaluate the advantages obtained from the aforementioned digital reproduction scheme, and it was rejected on that basis.

The second method was the one adopted, namely, use of an inexpensive, limited-capacity minicomputer to generate a CDC 6700-compatible input tape. This method has the advantage of machine accessibility, low operating and programming costs, and ease of program debugging. The limitations were machine capacities—both in memory size and

operating speed. The speed limitation restricted data translation to one channel at a time; the memory restricted the lengths of the data runs translated. Neither limitation adversely affected the evaluation of the DMTR because it required only short data runs on one channel. The actual transcription was made on an Interdata Model IV minicomputer with 16k of memory. This permitted approximately 4000 successive data points to be transcribed from one of the DMTR channels, and proved satisfactory for the intended evaluation.

## ADVANTAGES AND LIMITATIONS OF THE DMTR CONCEPT

The DMTR provides foremost a low-cost method of collecting data. Savings are realized in the cost of handling and reducing data as well as in the initial capital investment for equipment. This reduction can be as much as 50 percent or more compared to equivalent equipment that use FM formats. The savings are primarily related to the allowable reduction in equipment complexity because heavy tape speed control equipment is not required. This means fewer parts, fewer contacting surfaces, and less critical machining. Moreover, costly speed feedback control systems are not required. In addition the DMTR circuits are much simpler than those used in FM recorders and therefore less costly to manufacture.

A second source of savings relates to the equipment and time required to effect computer reduction of the data. The reproduced signal is already in a digital format and analog-to-digital conversion is not required. Hence savings are realized through reduced equipment usage costs, reduced personnel costs, reduced software costs, and quicker data turnaround times.

Quality performance is not sacrificed to cost. The DMTR performs to high degrees of accuracy and precision. In fact the DMTR will outperform most FM instrumentation tape recorders; the prototype has shown the capability to reproduce data with an accuracy of  $\pm 1$  percent of peak-to-peak full scale with comparable precision!

Another advantage is light weight which results from the lack of heavy precision tape speed control equipment. This, together with the achievable circuit simplicity, yields a machine which is easy to understand, easy to use, and easy to service. Further, because the recorded signals operate in the saturation regions of the oxide coating, rather inexpensive tape can be used compared to that required in FM work. Lastly, data for playback are simultaneously available in digital and analog forms.

The major limitation of the DMTR is the quantity of data which can be stored. Unlike FM formats in which sine waves can be multiplexed, and unlike pure digital formats where compaction techniques can be used, the DMTR requires the full-track bandwidth to record a channel of data. Thus the DMTR is limited to one channel per track. Only the use of high density recording heads (30 to 100 channels per inch) permits simultaneous recording of many channels. Further the DMTR must reproduce the symmetry of the recorded signal as well as the frequency. This requires about five to ten times the channel bandwidth needed to record and reproduce data in the FM format. The reproduced pulses must have as short a rise time as possible;

this requires additional bandwidth, approximately another factor of two. Thus for a given tape speed, the DMTR data bandwidth will be about 1/20 of that obtainable with FM. For example, the prototype built will reproduce 2.5 kHz data at a tape speed of 60 ips compared to the IRIG double-extended bandwidth of 40 kHz. However in view of the DMTR advantages and the low frequency content of most Navy R&D data, a 2.5 kHz bandwidth seems more than enough for most applications.

## DESCRIPTION AND EVALUATION OF MODEL 300

The NSRDC Model 300 Digital Magnetic Tape Recorder pictured in Figure 12 was developed to demonstrate and evaluate the capabilities of a tape recorder that uses DPWM principles. A Teac Model A-7030 tape deck (priced around \$750) was purchased and modified to satisfy the performance requirements for Model 300. These modifications included raising the tape speed to 60 ips, removing the audio electronics and installing the required DPWM electronics and related power supplies. In addition new heads were installed for erase, record, and reproduce. These are high-performance, fast-response digital heads selected specifically to record and reproduce the DPWM pulses. The record and reproduce heads contain seven independent tracks each, and permit the recording of seven independent channels of data. For digital playback, one of the channels was made a reference by grounding the input to that channel. A closeup of a section of DMTR tape (recordings made visible with Magne-See, a magnetic particle emulsion) is reproduced in Figure 13. Note the changing symmetry of the data signals recorded on Tracks 1, 3, 5, and 6.

## SALIENT PARAMETERS AND SPECIFICATIONS

The salient specifications, characteristics, and leading particulars are described in Table 1. These specifications are given for a tape speed of 60 rather than 30 ips although the recorder will operate at either.

Note that the input sensitivity is consistent with that available on most commercial instrumentation recorders. It permits a full-scale input of  $1 V_{rms} (\pm 1.414 V)$ , which is equivalent to a digital output count of  $\pm 141$  counts out of the possible  $\pm 256$  counts. Thus 55 percent of the range is utilized, and the resultant symmetry extends from 22.5 to 77.5 percent. This range avoids pulse cancellation on the tape when flux reversals are close together.

The accuracy specification defines the ability of the DMTR to reproduce the true input. The mean DMTR reproduced output will be within 1 percent (of peak-to-peak full scale) of the recorded input. Full scale is  $\pm 1.414 V$  or  $2.828 V$ ; 1 percent of full scale, then is approximately  $0.028 V$ . Thus for an input of  $+1V$ , for example, the mean reproduced output will be between  $+0.972$  and  $+1.028 V$ .

Precision is the specification which describes how well a measurement can be repeated. It is usually described in statistical terms. Precision is a description of the tightness of the



Figure 12 – Model 300 Digital Magnetic Tape Recorder Prototype

TRACK 1 200 Hz SQUARE WAVE



TRACK 2 UNMODULATED



TRACK 3 1 KHz SINE WAVE



TRACK 4 REFERENCE (UNMODULATED)

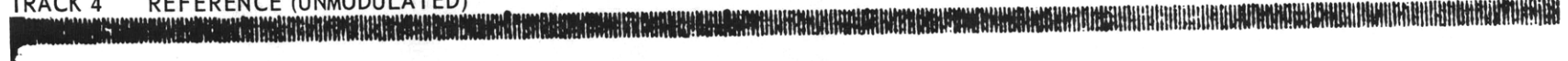

TRACK 5 100 Hz TRIANGULAR WAVE



TRACK 6 200 Hz SINE WAVE



TRACK 7 + VDC

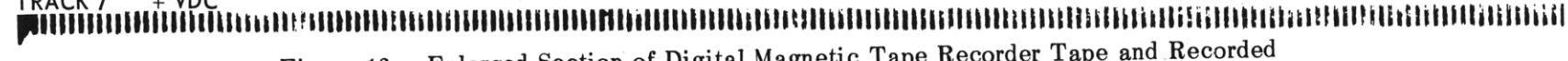

28

Figure 13 – Enlarged Section of Digital Magnetic Tape Recorder Tape and Recorded Differential Pulse Width Modulation Signals

Notice that the reference signal is recorded on track 4. Tracks 1,2,3,5,6, and 7 contain data. The vertical lines are the polarity changes of the DPWM signal.

**TABLE 1 – MODEL 300 DMTR SPECIFICATIONS**

(Specifications are for a tape speed of 60 ips)

<b>Electronics</b>	
Input Sensitivity (full scale)	1 V <sub>rms</sub> ( $\pm 1.414$ V)
Input Impedence	10 M $\Omega$
Accuracy (amplitude-analog and digital)	$\pm 1$ percent of full scale
Precision	$\pm 1$ percent of full scale (3 $\sigma$ level of significance)
Linearity (analog and digital)	$\pm 0.5$ percent full scale
S/N Ratio	48 dB (analog)
Digital Resolution (each datum point)	0.35 percent of full scale
Bandwidth	d-c to 2.5 kHz (-3 dB at 2.5 kHz)
Number of channels (including reference)	7
<b>Tape Deck</b>	
Type	Modified Teac A-7030
Reel Size (maximum)	10 1/2 in. (7200 ft of 1/2-mil tape)
Size	20 7/8 x 17 1/2 x 8 1/4 in.
Weight	Approximately 40 lb
Recording Time (at 60 ips)	24 min for 7200 ft of tape
Power Requirements	115 VAC, 60 Hz
Fast Winding/Rewinding Times	400 sec for 7200 ft of tape
<b>Tape</b>	
Type	3M Type 290
Cost (7200 ft)	Approximately \$9.00
Size	1/4 in. wide x 7200 ft long
Number of tracks (including reference)	7

distribution of measurements about the average value; 99.7 percent of the measurements will vary from the mean by a value no greater than three times the standard deviation ( $\sigma$ ) or  $3\sigma$ . The value of  $3\sigma$ , then, defines precision; for the DMTR, this value is 1 percent of full scale or 0.028V. Thus 99.7 percent of the reproduced samples will be within 0.028V of the average of all of the samples, and this average will be within 0.028V of the true value.

## CIRCUITS OF THE SUBSYSTEMS

The Model 300 circuits operate basically on the principles discussed previously. The schematics for Model 300 were recorded in seven NSRDC drawings that are included as Figures 14 through 20. The contents are tabulated below for quick reference.

Contents	Figure No.	NSRDC Dwg. No.
Block Diagram	14	B-851-1 Rev A
Tape Transport	15	B-851-2
Card Interconnections	16	B-851-3
Triangle Generator	17	B-851-4
Record Card	18	B-851-5 Rev B
Reproduce Card	19	B-851-6 Rev A
Five-Pole Butterworth Filter (analog demodulation)	20	B-851-7

These drawings cover only the circuitry contained physically within the recorder itself. In addition Figure 21 depicts the circuitry for the Differential Staggered Incremental Demodulator (NSRDC Drawing C-403 Rev D) which can be installed in place of the five-pole Butterworth filter if DSID-type analog demodulation is desired. The computer interface circuitry is shown separately in additional figures and will be discussed later.

### Block Diagram (Figure 14)

Figure 14 shows the capabilities of Model 300. Note that all seven channels (time referenced to one triangle generator) are simultaneously recorded and simultaneously reproduced. Recording and reproduction can be performed simultaneously (in other words, read after write); however, the reproduced data are slightly delayed because of the physical spacing of the record and reproduce heads. This spacing is approximately 1.92 in. and causes a 32-msec delay at 60 ips. Any one of the seven channels can be selected by a front panel switch and fed to the internal analog demodulator. Either the record signal or the reproduced signal can be so demodulated, and this choice is also made by a front panel switch. This capability is useful for field checking the recorded data and for setting up the tape recorder.

References given on Figure 14 direct the user to the other figures which pertain to each of the functional blocks of Figure 14.



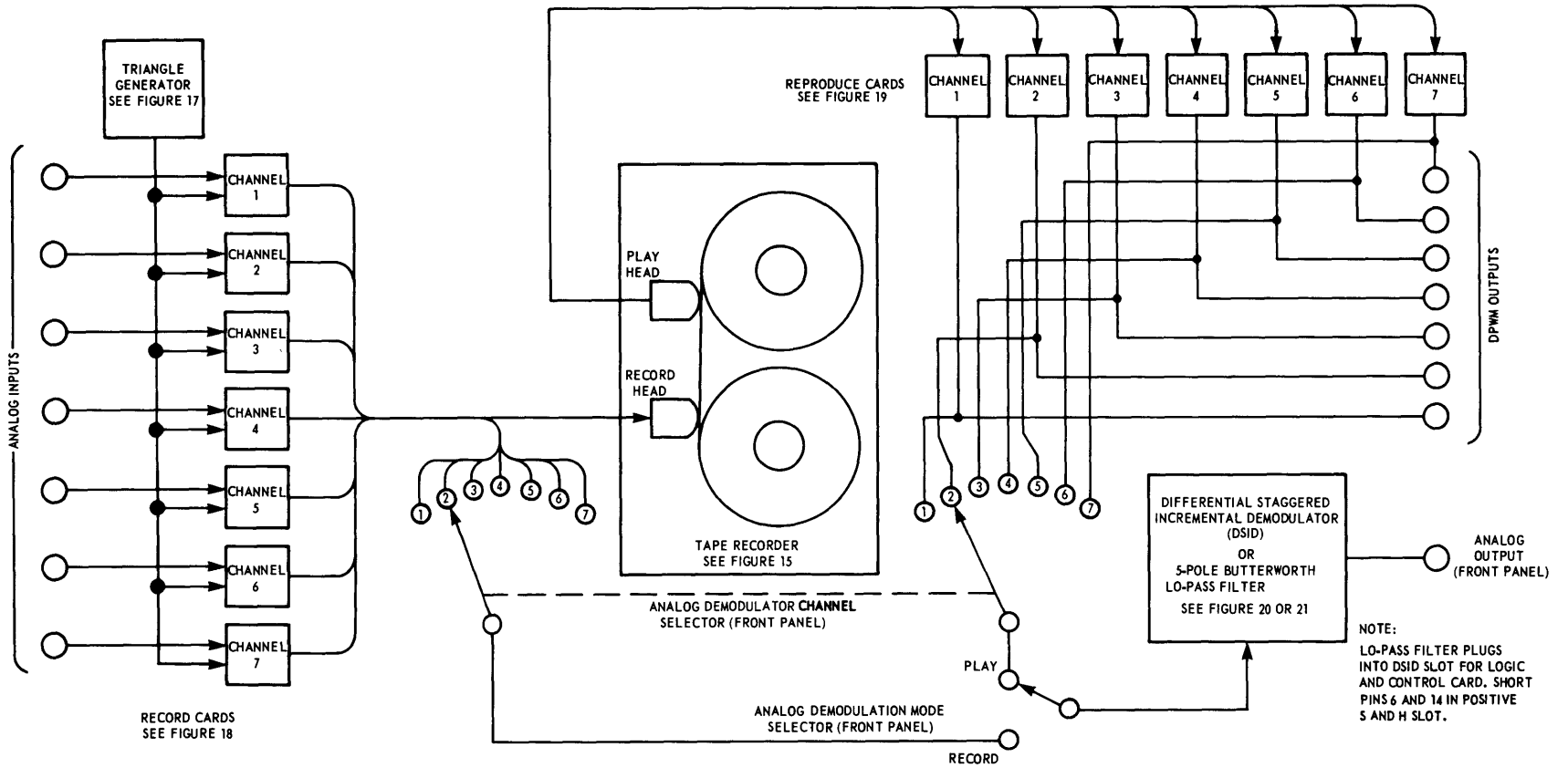

Figure 14 – Model 300 Block Diagram

### **Tape Transport Schematic (Figure 15)**

Figure 15 shows the internal wiring of the tape transport itself. All of the functions necessary to control the motion of the tape are included here together with a schematic of the erase oscillator. The oscillator operates at a frequency of 125 kHz and is used in the record mode to erase all tracks simultaneously before the tape passes the record head. Selective single track erasure is not provided. The erase circuit is functional in the record mode. Because of the high magnetization levels used in the DPWM recording process, it is highly desirable to preprocess tape previously recorded with DPWM signals through a bulk tape eraser. This device can generate an erase flux field whose strength far exceeds the strength that can be generated by the erase head. The bulk tape eraser will ensure the least residual magnetism in DMTR recordings and thus the greatest signal-to-noise ratio.

### **Card Rack Interconnecting Diagram (Figure 16)**

Figure 16 indicates the interconnections for the card rack, the power supply connections, and the external switches and resistors for the analog demodulator. This schematic is self-explanatory.

### **Triangle Generator (Figure 17)**

A self-regenerating triangle generator is used because of its simplicity and stability. The frequency of the triangle generator, and thus the sampling rate of Model 300, is 12.5 kHz. Note from Figure 17 that the circuit consists of only two operational amplifiers and their associated components. A1 operates as a comparator to generate a square wave whose amplitude is controlled by the closely matched zener diodes D1 and D2. This matching is required in order for the rates of positive and negative integration to be the same at integrator A2. And these rates must be the same in order to produce a triangular wave with positive and negative slopes of equal magnitude. The integrating constant of A2, and thus the triangular wave frequency, is controlled by R9.

The triangle output is sampled by R4, and fed back to the comparator to complete the loop. The ratio of square wave (fed back through R6 and R7) to triangular wave feedbacks determines the amplitude of the triangle. That is, the triangle amplitude must overcome the square wave fed back at the positive input to the comparator in order to generate a comparator output change.

To illustrate, assume that the A1 output is in its positive state, say, +10 V. The output of A2 decreases in a ramp-wise fashion because it operates as an inverting integrator. If R7 is at its midpoint such that  $R6 + R7 = 13.5 \text{ k}\Omega$  by superposition the voltage at the positive input to A1 (pin 3) is 4.024 V (due to the +10 V at the output of A1 plus  $0.598 \times$  triangle output voltage). The comparator will not change state until its inputs are at the same potential. Nominally the negative input (pin 2) is at 0 V so the following equation prevails:

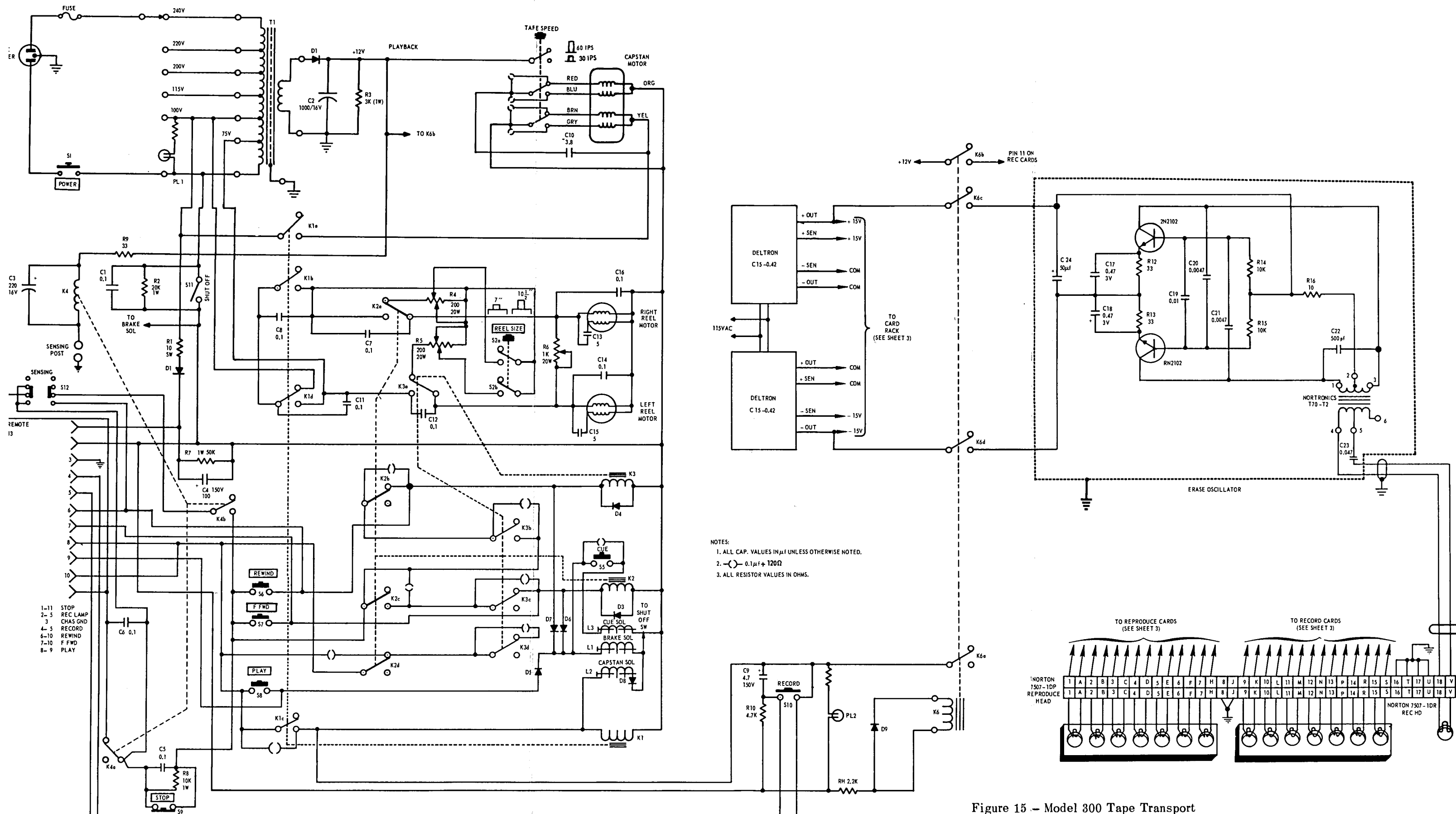
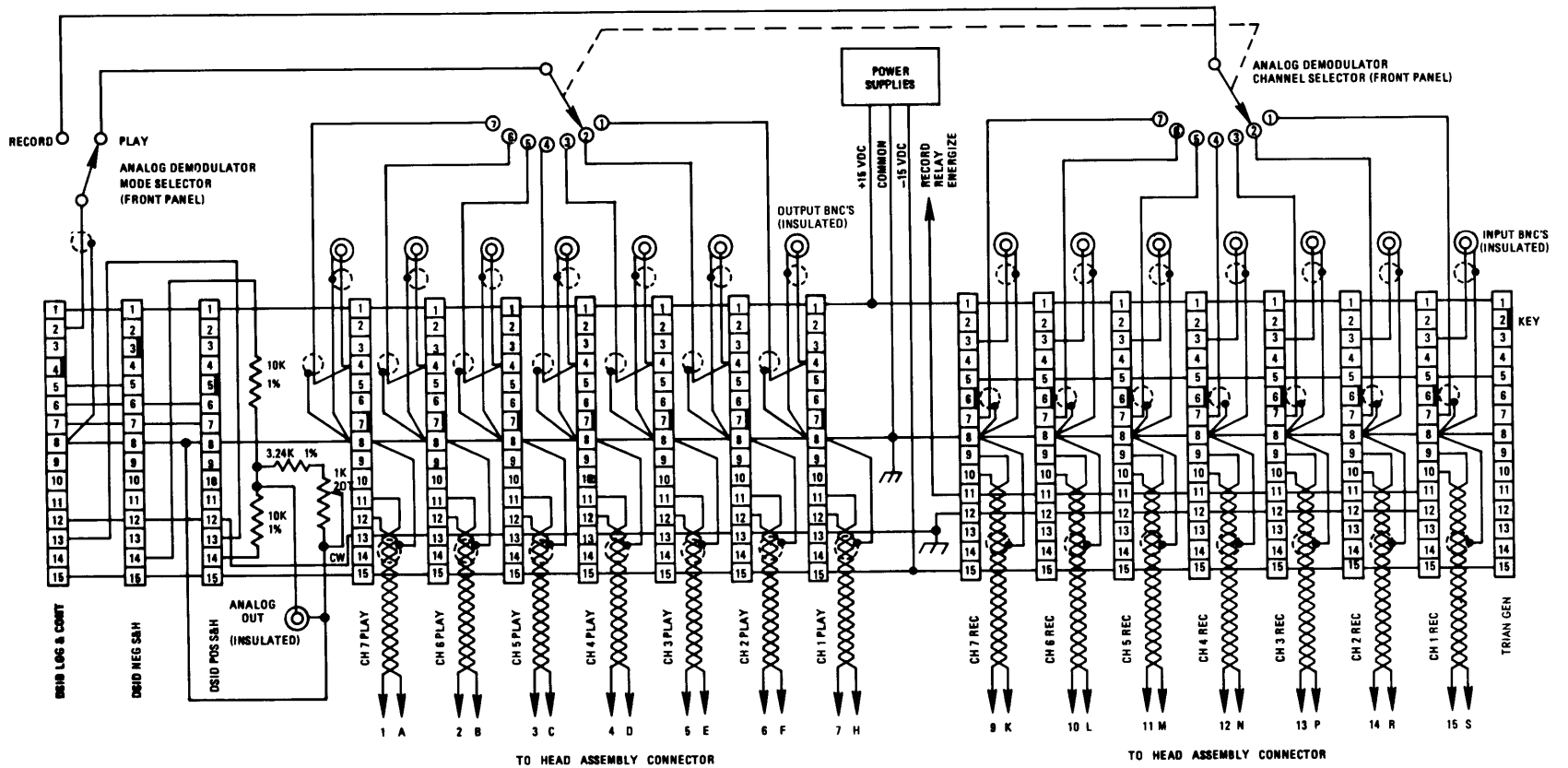

Figure 15 - Model 300 Tape Transport





- NOTES.**
1. CARD RACK SHOWN FACING REAR OF TAPE RECORDER
  2. CARDS ARE INSERTED COMPONENT SIDE FACING TRIANGLE GENERATOR
  3. ALL INTERLEAVED SHIELDS CONNECTED TO CHASSIS, NOT  $\pm 15$  VDC COMMON
  4. ALL SHIELDS FLOATED AT ONE END

Figure 16 – Model 300 Card Rack Interconnections



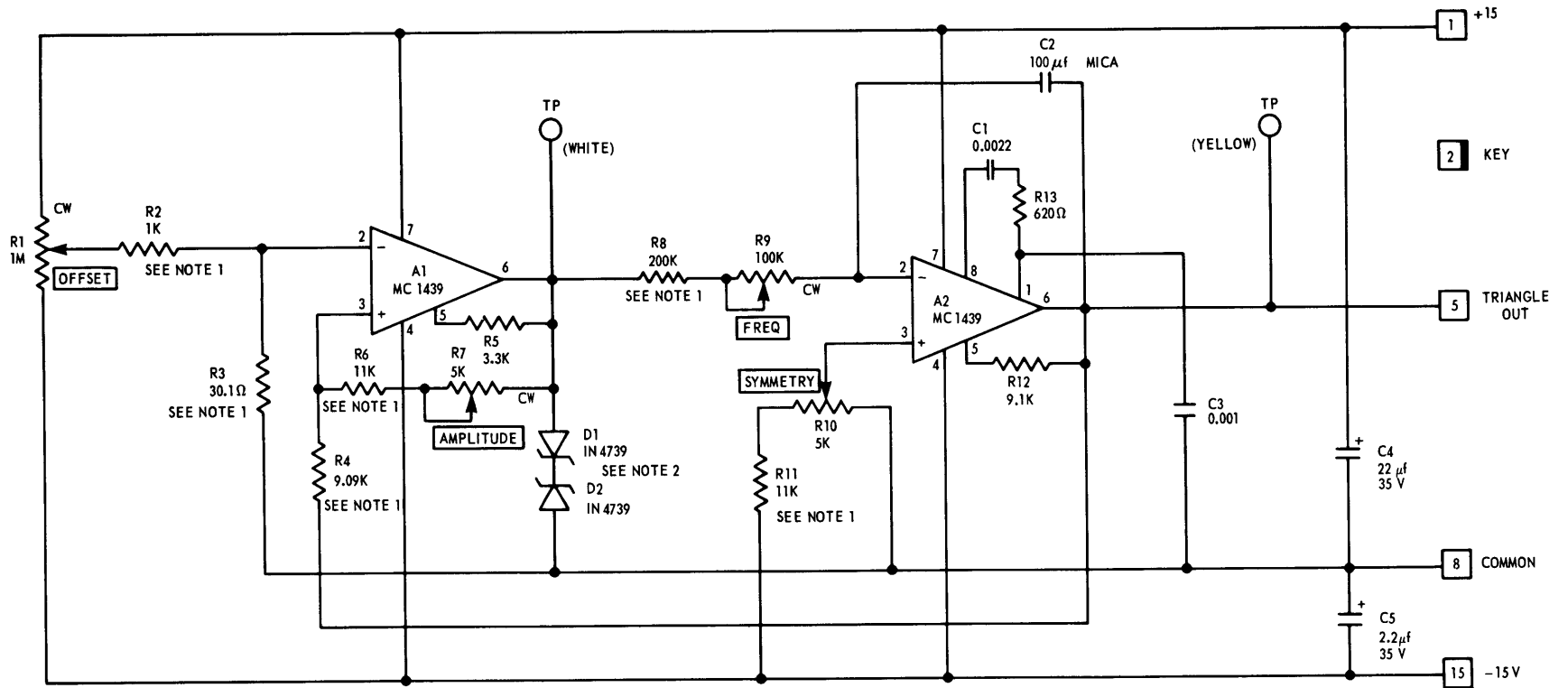

NOTES:

1. RESISTOR IS 1 PERCENT METAL FILM
2. D1 AND D2 MATCHED IN REVERSE DIRECTION (9.1V)

ORDER OF ADJUSTMENT:

1. AMPLITUDE (P-P)
2. SYMMETRY
3. FREQUENCY
4. OFFSET

ONE REQUIRED PER RECORDER

Figure 17 – Model 300 Triangle Generator

$$0.598 \times (\text{triangle output voltage}) + 4.024 V = 0$$

Solving:

$$\text{Triangle output} = - \frac{4.024}{0.598} = - 6.729 V$$

Thus, when the triangular wave amplitude reaches  $-6.729 V$ , a comparison is made by A1 which reverses its output to  $-10 V$ . A2 now begins integration in the positive direction, and the process is repeated continuously.

The offset and symmetry of the triangular wave are controlled by R1 and R10, respectively. R1 adds in a small voltage to adjust the comparison levels, thus adjusting the negative and positive extremities of the triangle up and down together. Similarly R10 supplies whatever small voltage is required to equalize the positive and negative integration rates.

### Record Card (Figure 18)

The record card accepts the datum signal and the triangular wave, produces a corresponding DPWM signal, conditions the signal, and presents it to the record head. FET Q1 provides high signal input impedance. FET Q2 likewise provides large triangular wave input impedance so that the triangle generator can supply many record cards. Sensitivity and offset adjustments are also conveniently provided at this stage.

The DPWM comparisons are made by A1. The resultant signal amplitudes are clipped to the desired level by D1 and D2. This signal is sent to the record current amplifier through resistors R9 and R10. Preemphasis in the form of the DPWM derivative to generate the sharp rise and fall times in the record head is provided by C1 (padded by C5). This sum of the DPWM signal and its derivative is accepted by A2 and sent on to the record head as a current. This same current returning from the head passes through R13, generating the necessary feedback signal. When not recording, R12 ( $1 M\Omega$ ) is inserted in the feedback loop, thus reducing the gain of the amplifier. The desired record current and compensation (preemphasis) to produce the best results can be adjusted by R11 and R10, respectively.

### Reproduce Card (Figure 19)

The reproduce function in the DMTR consists of retrieving the low-amplitude differential pulse position modulation (DPPM) pulses from the tape, amplifying the pulses, and converting them back again to DPWM. C1 in parallel with the reproduce head tunes the input circuit to the best resonance for the reproduced signal. The signal is amplified by A1 which operates with a gain of 1000. The amplified pulses are conveyed to comparator A2 through C4 which blocks any d-c offset which might exist at the output of the amplifier. The comparator with adjustable hysteresis is set to trigger on the pulses and reject the residual noise level. The reconstructed DPWM appears directly at the comparator output. Because of the large signal



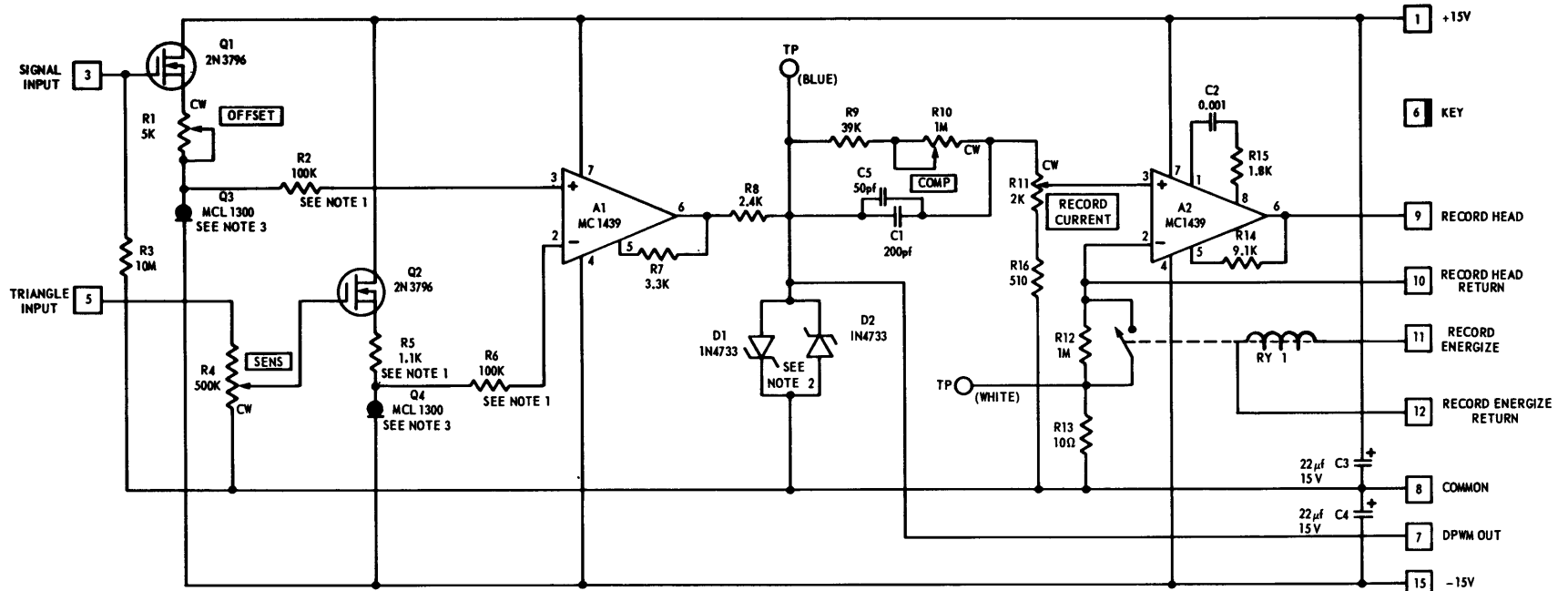

- NOTES:
1. RESISTOR IS 1 PERCENT METAL FILM
  2. D1 AND D2 MATCHED IN FORWARD DIRECTION
  3. Q3 AND Q4 MATCHED  $\pm 20$  PERCENT

SEVEN REQUIRED PER RECORDER

Figure 18 – Model 300 Record Card

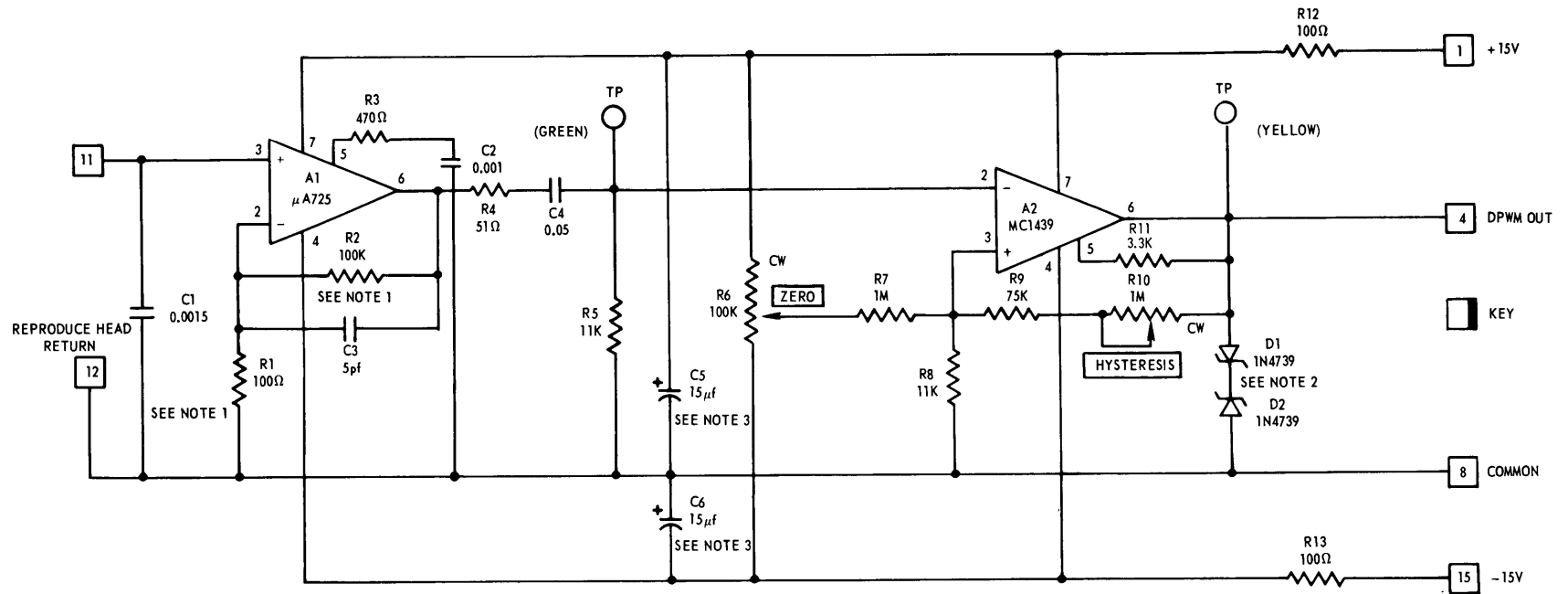

NOTES:

1. RESISTOR IS 1 PERCENT METAL FILM
2. D1 AND D2 MATCHED IN REVERSE DIRECTION (9.1V)
3. LOCATE NEAR P C PINS

Figure 19 – Model 300 Reproduce Card

SEVEN REQUIRED PER RECORDER

at A2 and the small signal at A1, isolation resistors R12 and R13 and decoupling capacitors C5 and C6 are used to minimize effects on and by the power supplies.

### **Five-Pole Butterworth Filter Analog Demodulator (Figure 20)**

A1 of the low-pass filter is simply an operational amplifier operating open loop (gain = 100,000) with 10-V clipping diodes on the output. This permits the circuit to accept and identically demodulate DPWM signals of any amplitude. The resulting normalized DPWM signal is then sent to the two-stage, five-pole active filter consisting of A2, A3, and their associated components. Signal offset control is provided at the input of A2, and overall circuit gain control is provided at the output of A2.

### **Differential Staggered Incremental Demodulator-DSID (Figure 21)**

If desired, the DSID can be installed in place of the low-pass filter. As shown in Figure 21, the DSID operates similarly to the description given previously. As in the filter, a normalized DPWM signal is produced by A2, permitting signals of all amplitudes to be accepted. The complete DSID is contained on three circuit cards. The LOGIC and CONTROL card contains the signal-normalizing amplifier mentioned above, an amplifier which produces an inverted DPWM signal, and the logic modules which generate the reset pulses. The inverted DPWM is called the COMPENSATION signal because it compensates for the charge fed through to the "hold" capacitors, C9 and C18, when the FET switches PQ4 and NO4, change the hold amplifiers from the read mode to the hold mode.

The POSITIVE SAMPLE AND HOLD card performs the functions relating to the positive or "A" half of the DPWM sample. Likewise the NEGATIVE SAMPLE AND HOLD card performs those functions relating to the negative or "B" half. The resulting waveforms are depicted in Figure 10f and 10h, respectively. These signals are summed together through resistors R44 and R45 (also shown in Figure 16) and made available on the tape recorder front panel. The resultant demodulated signal is similar to that of Figure 10i.

### **Digital Interface Electronics (Figure 22)**

The digital evaluation of Model 300 was done on a CDC 6700 digital computer. This computer requires an input tape of certain format which was generated on an Interdata Model IV minicomputer. The digital interface electronics were designed to mate the DMTR with the Model IV. The output format available from the interface can be either binary or BCD. Binary was used with Model IV. A block diagram for the entire interface is presented in Figure 22. The schematics are given on two drawings, Figures 23 and 24.

As indicated on Figure 22, the gating card is used to convert the DPWM signal to micrologic-compatible levels (TTL and DTL types) of 0-5 V. The present prototype allows for the digital conversion of only one channel at a time. The selection of one of the outputs

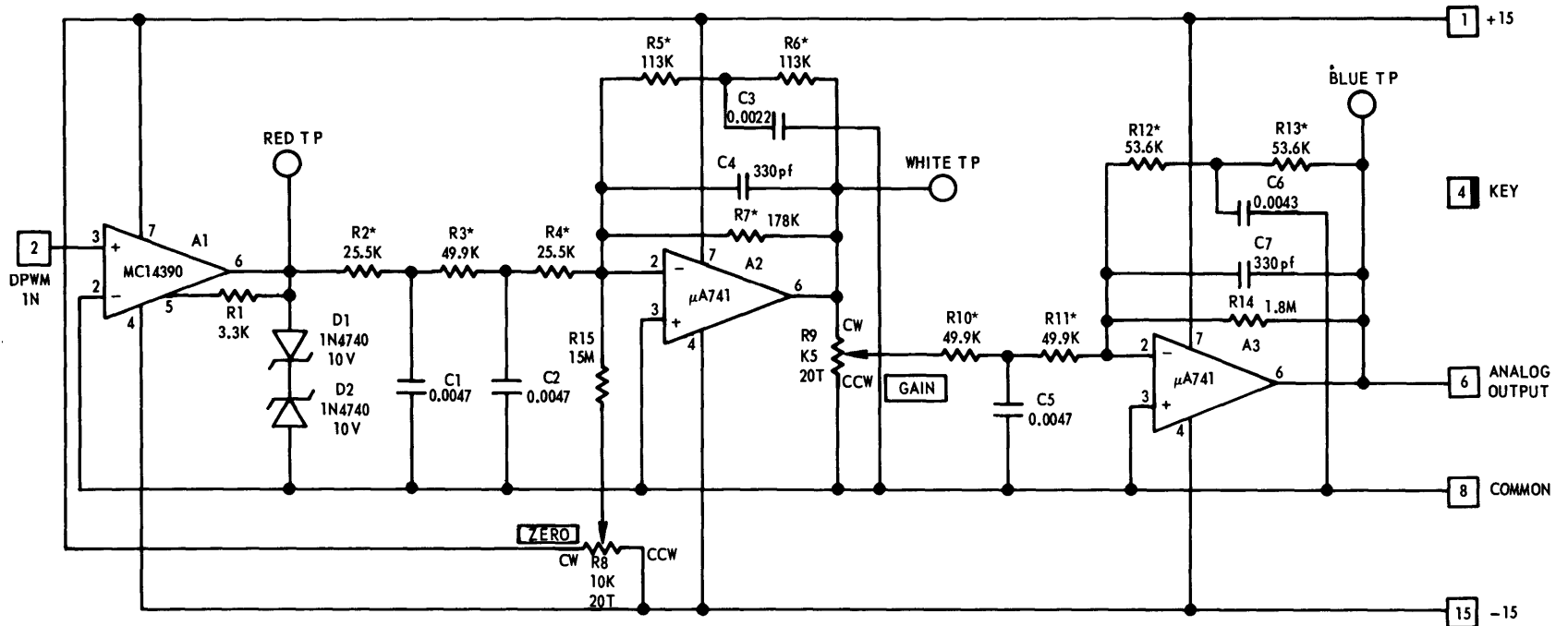

## NOTES:

1. "\*" INDICATES 1 PERCENT METAL FILM RESISTOR.
2. THIS ANALOG DEMODULATOR IS INTENDED FOR USE IN PLACE OF THE DIFFERENTIAL STAGGERED INCREMENTAL DEMODULATOR (NSRDC DWG C-403.) THEY CANNOT BE USED SIMULTANEOUSLY. THE CARD SHOWN REPLACES THE DSID LOGIC AND CONTROL CARD; THE POSITIVE S AND H CARD IS REPLACED BY A CARD WITH PINS 6 AND 14 SHORTED TOGETHER; AND THE NEGATIVE S AND H CARD IS NOT USED.
3. DATA INTELLIGENCE BANDWIDTH IS 2500 Hz (-3dB), AND AT 12.5 KHz (THE CARRIER FREQUENCY) THE OUTPUT IS -76dB.
4. ONE REQUIRED PER RECORDER.

Figure 20 - Model 300 Low-Pass Filter Analog Demodulator

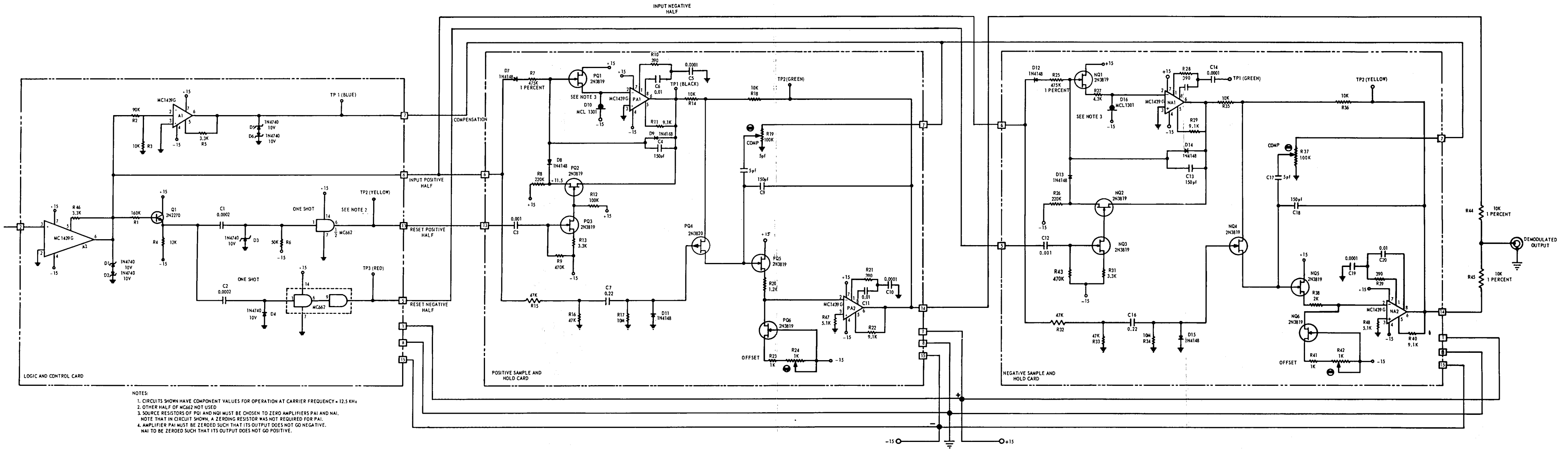

Figure 21 – Model 300 Differential Staggered Incremental Demodulator



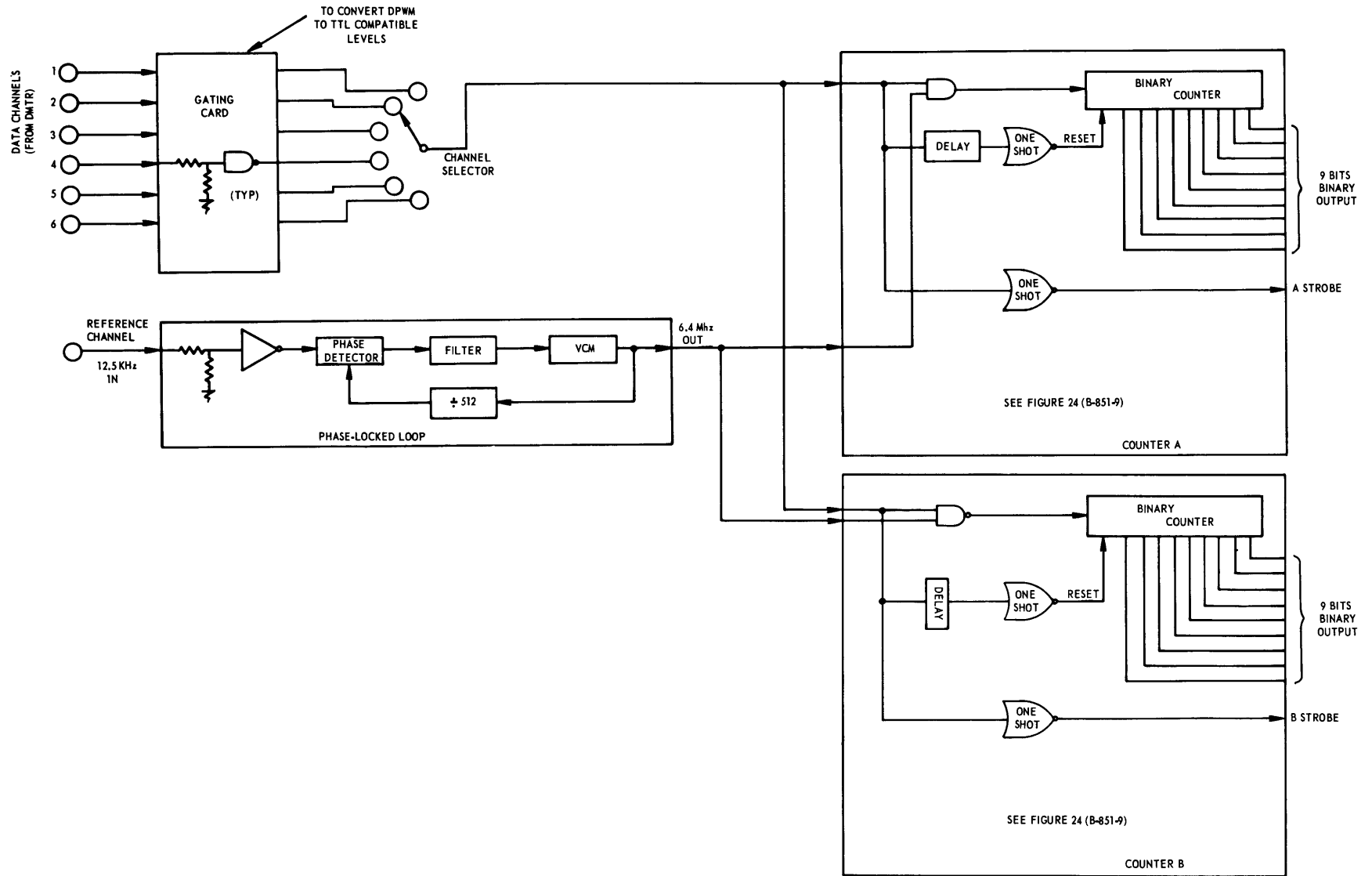

Figure 22 – Digital Interface Electronics General Arrangement





of the gating card can be made with the channel selector. Additional channel demodulation capabilities can be provided by adding counters for each desired channel. Additional PLL's are not required.

The tape track selected as the reference is plugged into the PLL input. This is also buffered by an inverter to provide TTL/DTL levels. The PLL itself is composed of microcircuits with the proper external components to provide a multiplication of 512 (the multiplication factor used with Model 300) and the required filtering. The selected data signal and the output of the PLL are both fed to each of two counter cards. The *A*, or positive, portion of a DPWM sample is used to gate the 6.4 MHz reference into counter *A*. Likewise the *B* portion is used to gate the reference into counter *B*. At the end of each gated burst, the values of *A* and *B* are available at the outputs of the respective counters in 9-bit binary form (BCD is also easily provided by merely changing from hexadecimal to decade counters). The strobe is present between the times the counter is finished counting and the reset pulse appears. The strobe can be used to tell the computer that the data are present and available for reading. *A*'s and *B*'s occur in pairs at a rate of 12,500/sec/channel.

**Gating Modules and PLL (Figure 23).** This circuitry provides the necessary buffering of the DPWM signals from the tape recorder to convert to micrologic-compatible levels. The buffering is provided by the MC 1806 quad AND gate chips.

The circuitry of Figure 23 also contains the PLL. Motorola microcircuits were used. Five chips and an external filter are required. The MC 4044 phase frequency detector receives the reference frequency (12.5 kHz) rectangular wave from the DMTR and the divided-down 6.4 MHz "sprocket" output. The phase difference between these signals is measured and converted by the filter into a d-c voltage (proportional to the phase difference) used to correct the 6.4 MHz VCO. The VCO is changed in such a manner as to eliminate the phase error. The 6.4 MHz is divided by the three MC4016 programmable counters, thus closing the loop.

**Counter for Digital Interface Electronics (Figure 24).** This counter module accepts the DPWM data rectangular wave train and the 6.4 MHz reference signal from either the PLL or a free-running oscillator. The reference is gated by the data signal in the first AND gate of the MC 1806, producing a pulse burst equivalent to the datum value. This pulse burst is counted by the three hexadecimal counters (MC 839's) and gated through the MC 3001 output AND gates. The necessary timing and control signals are generated by the one-shot circuitry made from the MC 858 NAND gates. Typical circuitry waveforms are shown at the designated circuit locations.

## MODEL 300 DMTR EVALUATION

On completion of construction of the Model 300 prototype, evaluation tests were structured to demonstrate its capabilities. Data for both analog and digital playback modes were desired. A single test tape was manufactured to evaluate the recorder. This tape

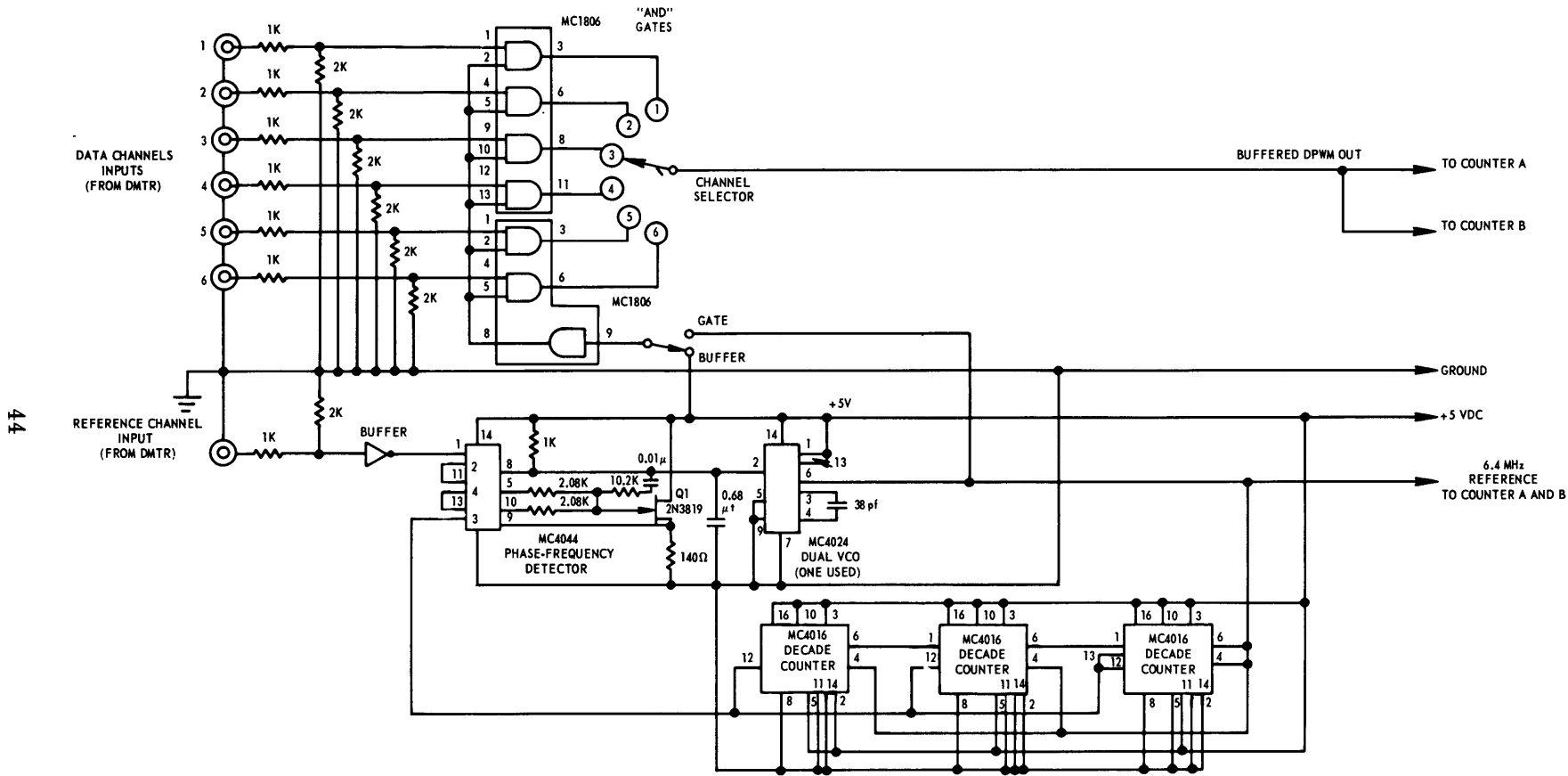

44

Figure 23 – Digital Interface Electronics – Gating Modules and Phase-Locked Loop

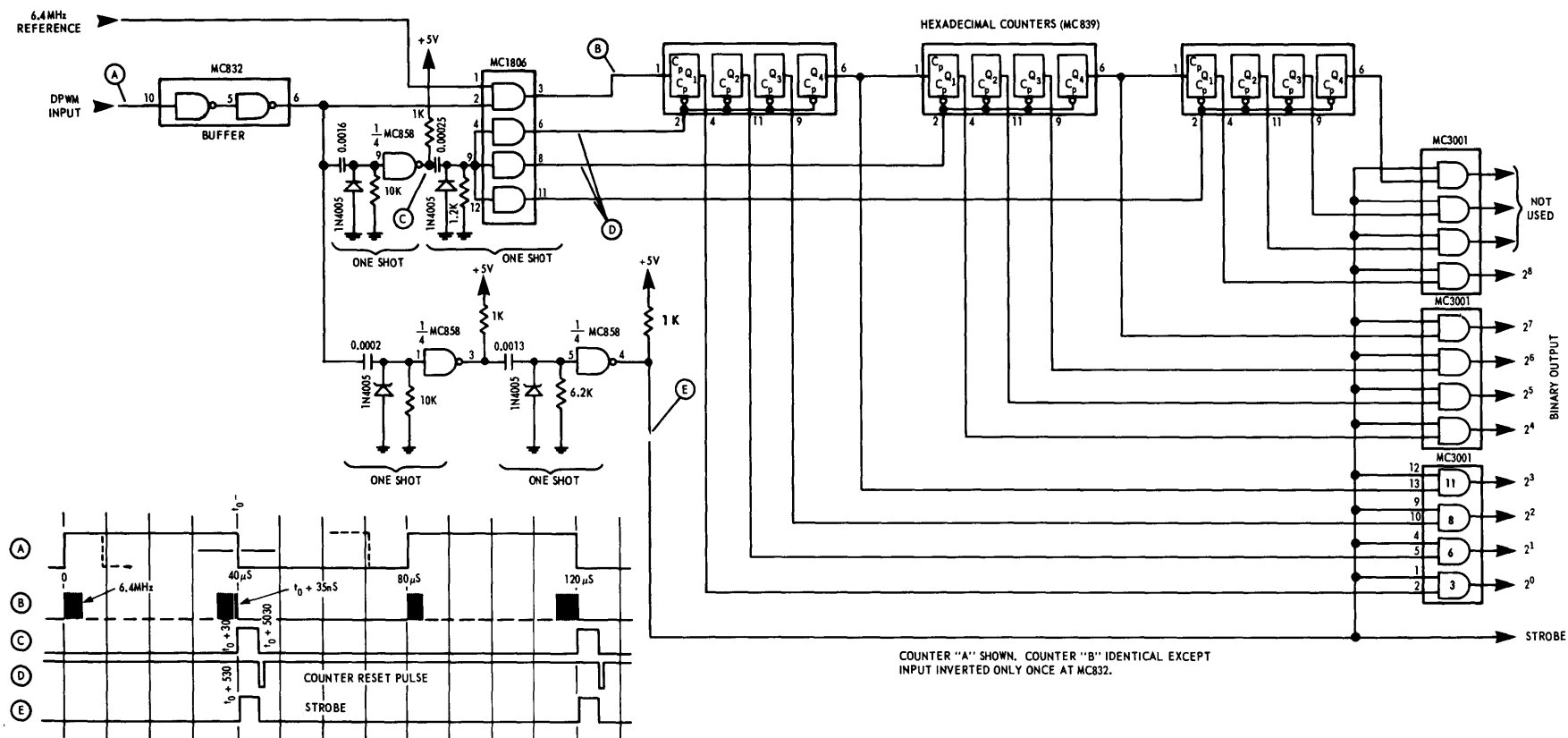

Figure 24 – Digital Interface Electronics Counter

contained 17 static data levels covering the full-scale range ( $\pm 1.414 V$ ) of Model 300. On the same tape were made seven dynamic calibration records which cover the frequency range of the recorder. The tape was labeled TT-1, and its contents are listed in Table 2. In making this tape, channels 2 and 6 were impressed with the data listed in Table 2, and channel 4 was shorted at the input to produce the reference. The static levels were imposed with a General Precision DIAL-A-SOURCE, Model DAS-46. The dynamic signals were applied with a Wavetek Model 142 Oscillator.

Because Model 300 had read after write capability, more extensive analog tests were performed than permitted by test tape TT-1. These were performed by simultaneously recording and playing back while making measurements at the analog output. These tests were performed on channels 2 and 6. The results were discussed in the following section.

### Analog Tests

All tests were conducted with a five-pole Butterworth low-pass filter installed for analog demodulation.

The analog output from test tape TT-1 is given for comparison in the section on digital tests. The data presented here were taken with the DMTR in the record mode with simultaneous playback. These data are more exhaustive than those recorded on TT-1, and are used for that reason. The test setup is shown in Figure 25. From this setup the information of Table 3 and Table 4 was obtained. As indicated in Table 3, the worst deviation from the ideal straight line, and hence the accuracy (only in-range data considered), was 0.39 percent of the  $p - p$  full scale (at an input of  $+1.000 V$ ) for channel 2, and 0.32 percent of full scale (at an input of  $-1.400 V$ ) for channel 6. The worst nonlinearities from the calculated best straight lines were 0.32 and 0.14 percent full scale for channels 2 and 6 respectively. The error curves for the data of Table 3 are shown in Figure 26. The calculated best straight lines are for channel 2:

$$V_{\text{out}} = 0.9955 V_{\text{in}} - 0.00124$$

and for channel 6:

$$V_{\text{out}} = 0.9953 V_{\text{in}} + 0.00076$$

The frequency response characteristics were investigated only for channel 2. First the response characteristics of the filter alone, then the filter plus the system were measured. The results are tabulated in Table 4 and presented graphically in Figure 27.

The output signal-to-noise (S/N) ratio was measured at zero and at positive and negative full scale. In no case was the rms noise level worse than 48 dB below the full-scale rms signal level of  $1V_{\text{rms}}$ .

The playback stability (that is, the stability of the analog demodulator) was checked by repeatedly replaying the same section of tape over a 3-hr period. The drift for the six repetitions made at 30-min intervals (constant ambient temperature  $\pm 2^\circ F$ ) was 0.07 percent

TABLE 2 – CONTENTS OF MODEL 300 EVALUATION  
TAPE TT-1

File	Condition	Start Time (min)	Tape Counter (Start)
1	0.000 V	0:00	0000
2	-1.414 V	0:30	0070
3	-1.200 V	1:00	0140
4	-1.000 V	1:30	0200
5	-0.800 V	2:00	0290
6	-0.600 V	2:30	0375
7	-0.400 V	3:00	0445
8	-0.200 V	3:30	0520
9	0.000 V	4:00	0600
10	0.200 V	4:30	0700
11	0.400 V	5:00	0770
12	0.600 V	5:30	0845
13	0.800 V	6:00	0930
14	1.000 V	6:30	1010
15	1.200 V	7:00	1100
16	1.414 V	7:30	1185
17	0.000 V	8:00	1270
18	10 Hz, 1 V <sub>rms</sub>	8:30	1360
19	100 Hz, 1 V <sub>rms</sub>	9:00	1450
20	500 Hz, 1 V <sub>rms</sub>	9:30	1550
21	1 kHz, 1 V <sub>rms</sub>	10:00	1650
22	2 kHz, 1 V <sub>rms</sub>	10:30	1760
23	2.5 kHz, 1 V <sub>rms</sub>	11:00	1860
24	3 kHz, 1 V <sub>rms</sub>	11:30	1970
		12:00(off)	

47

TABLE 3 – DATA FROM ANALOG EVALUATION  
USING STATIC LEVELS

(The sign of the numbers in the error columns  
indicate direction of error)

	Input (V)	Output (V)		Error (Percent FS)	
		Channel 2	Channel 6	Channel 2	Channel 6
Over Range	-1.600	-1.598	-1.582	0.07	0.64
	-1.500	-1.505	-1.488	-0.18	0.42
	-1.400	-1.404	-1.391	-0.14	0.32
	-1.300	-1.302	-1.292	-0.07	0.28
	-1.200	-1.196	-1.196	0.14	0.14
	-1.000	-0.992	-0.995	0.28	0.18
	-0.800	-0.792	-0.796	0.28	0.14
	-0.600	-0.593	-0.596	0.25	0.14
	-0.400	-0.395	-0.400	0.18	0
	-0.200	-0.197	-0.199	0.11	0.03
	0.000	0.001	-0.001	0.03	-0.03
	0.200	0.198	0.200	-0.07	0
	0.400	0.396	0.402	-0.14	0.07
	0.600	0.593	0.602	-0.25	0.07
0.800	0.792	0.800	-0.28	0	
1.000	0.989	0.996	-0.39	-0.14	
1.200	1.191	1.195	-0.32	-0.18	
1.300	1.294	1.292	-0.22	-0.28	
1.400	1.396	1.392	-0.14	-0.28	
Over Range	1.500	1.501	1.487	0.03	-0.46
	1.600	1.605	1.582	0.18	-0.64

TABLE 4 – FREQUENCY RESPONSE DATA FOR DIGITAL  
MAGNETIC TAPE RECORDER ANALOG EVALUATION  
WITH LOW-PASS FILTER

Frequency (Hz) (Constant Amplitude)	Filter Output (V)	Filter Output (dB)	System Output (V)	System Output (dB)
10	*		0.998	0
20	*		1.000	0
50	1.000	0	1.004	+ 0.34
100	1.000	0	1.006	+ 0.50
200	*		1.004	+ 0.34
300	1.000	0	*	
500	0.998	0	0.994	- 0.06
1000	0.994	- 0.06	0.982	- 0.16
1500	0.996	- 0.04	0.980	- 0.18
2000	0.967	- 0.28	0.952	- 0.43
2300	0.872	- 1.20	*	
2500	0.760	- 2.38	0.751	- 2.48
2700	0.625	- 4.08	*	
3000	0.435	- 7.22	0.435	- 7.22
5000	0.042	-27.54	0.140	-17.08
7000	7.8 mv	-42.16	beginning of aliasing	
10000	1.1 mv	-59.18		
12500	0.3 mv	-70.46		
15000	0.1 mv	-80.00		
20000	0			

\*Data point not taken.

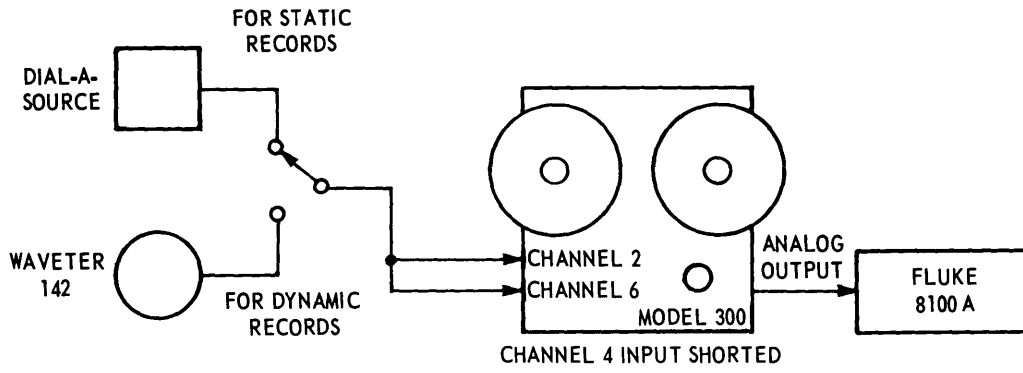

Figure 25 – Analog Evaluation Test Setup

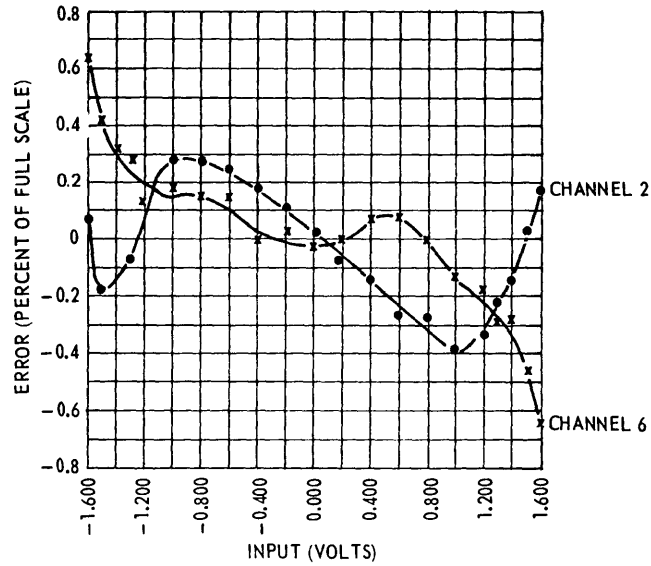

Figure 26 – Error Curves for Channels 2 and 6 (Analog Playback)

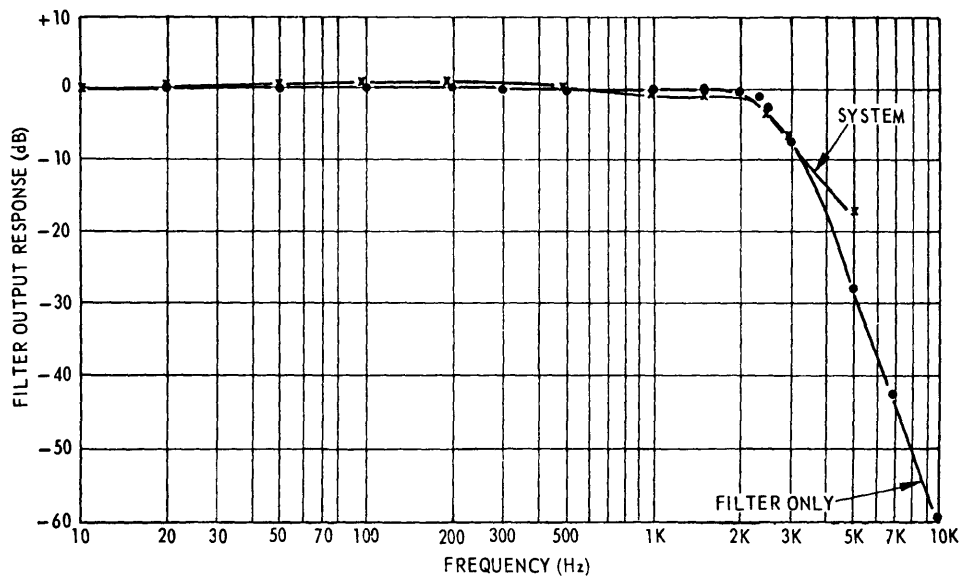

Figure 27 – Analog Frequency Response

of full scale. A further check was made over this same period to determine how faithfully the DMTR could repeat record and reproduce data. This check revealed a drift of 0.3 percent of full scale.

In summary, the following parameters of the DMTR in the analog playback mode were determined from measurement:

Accuracy	= 0.4 percent of full scale
Linearity	= 0.3 percent of full scale
S/N Ratio	≥ 48 dB
Bandwidth	d-c to 2.58 kHz (-3 dB at 2.58 kHz)
Drift (3-hr period)	< 0.1 percent reproduce 0.3 percent record and reproduce

### Digital Tests

All digital evaluation was performed on the data from channel 2 (see also Appendix B). More than one channel would have been used except for the tremendous volume of data that would have been generated. Checks with the analog demodulator indicated that channel 2 was a fair, representative channel.

The final computations were made in a CDC 6700 high-speed digital computer. The DMTR concept lends itself to direct interface of the DMTR with such a computer. If this were done, the recorder would become an on-line peripheral. However, this possibility was ruled out because of the investigative nature of the DMTR effort, and some other input device to the CDC 6700 had to be used. The device chosen was the nine-track tape recorder. The necessary nine-track tape was generated by hard-wire interfacing the DMTR to an Interdata Model IV minicomputer and outputting the Model IV in nine-track format. For the intended purpose, this solution was as good as if not better than interfacing directly to the 6700. Not only was the interfacing technique proven, but the evaluation was less costly and time consuming because of the almost infinitesimal cost of Model IV time compared to 6700 time and the much greater availability of the Model IV.

**Test Configuration and Techniques.** Test tape TT-1 was used exclusively for the digital evaluation (refer to Table 2 for the contents of the 24 files on TT-1). The outputs of channel 2 and channel 4 (the reference channel) were connected to the interface electronics described in Figures 22-24. Each of the two nine-bit outputs (counter A and counter B) were then fed to a nine-bit latch which lengthened the time during which the data were available. Each strobe pulse was fed to an adjustable one-shot. In these ways, the timing of the signals was optimized for Interdata Model IV use.

The Model IV used was equipped with 16,000 eight-bit memory locations; 640 of these locations were required for program storage. Each DMTR counter output consists of nine bits so that two Model IV memory locations were required for each counter output (the remaining seven bits were used for identification). Since both counter outputs were required



for the evaluation, a total of four memory locations was used to store each datum sample. Therefore after removal of the 640 memory locations for the program (leaving 15,360), a total of 3840 datum samples were storable. This represents 307.2 msec of data at the Model 300 rate of 12,500/sec. The lowest frequency on TT-1 (file 18) is 10 Hz, so that even this short sampling yields three complete cycles of data.

On completion of the memory loading, the data were block transferred to a nine-track tape recorder (Kennedy Model 3110) which produced the CDC 6700 compatible tape. Each of the 24 files were sampled, first with a PLL in the digital interface electronics and then with the PLL replaced by a free-running oscillator which operated near the nominal 6.4 MHz frequency required. Thus the resultant nine-track tape, ready for loading onto the CDC 6700, contained a total of 48 files. For surety two such tapes were made (not copies) and are designated DTT-1 and DTT-2.

Digital test tape DTT-2 was then played into the CDC 6700 and the data it contained were analyzed. The following information was provided as output data from the computer for each file:

1. Listing of all  $A$ 's and  $B$ 's in pairs for record purposes
2. Histogram (distribution) of  $A + B$
3. Range of  $A + B$
4. Mean of  $A + B$
5. Standard deviation ( $\sigma$ ) of  $A + B$
6. Listing of all  $V_1$ 's

$$\left( V_1 = \frac{\frac{512 A}{A + B} - 256}{100} \right)$$

7. Listing of all  $V_2$ 's

$$\left( V_2 = \frac{A - 256}{100} \right)$$

8. Means of  $V_1$ 's and  $V_2$ 's
9. Standard deviations of  $V_1$ 's and  $V_2$ 's

In addition the following was obtained for only the dynamic data (files 18–24 and 42–48):

10. Graphical outputs of a few cycles of the data from each file automatically computer plotted. Both  $V_1$  and  $V_2$  were plotted for each dynamic file.
11. Data distributions for each dynamic file.

**Reduced Computer Results.** The data for the static files are summarized in Table 5. Note that the value  $3\sigma$  (three standard deviations) is given for each voltage; 99.7 percent of all the samples for each voltage varied from the mean by no more than  $3\sigma$  value for that voltage. Figure 28 shows the error curves for  $V_1$  with and without a PLL as well as  $3\sigma$  precision bands. The error curves for  $V_2$  using a PLL are shown in Figure 29. Notice the loss of precision at those levels for which a dropout occurred on the reference track. The following conclusions can be drawn from these data.

TABLE 5 – SUMMARY OF DIGITAL EVALUATION RESULTS FOR THE STATIC FILES

	File Number	Input (volts)	A + B		V <sub>1</sub>		V <sub>2</sub>		Analog Output
			Mean	$\sigma$	Mean	$3\sigma_1$	Mean	$3\sigma_2$	
Phase-Locked Loop Reference	1	0.000	512.0	2.213	-0.006	0.025	-0.006	0.041	0.000
	2	-1.414	512.0	2.386	-1.412	0.021	-1.412	0.027	-1.428
	3	-1.200	512.0	2.300	-1.197	0.021	-1.197	0.029	-1.201
	4	-1.000	512.0	2.559	-0.998	0.022	-0.998	0.033	-0.995
	5	-0.800	511.9	3.216	-0.783	0.036	-0.785	0.111	-0.785
	6	-0.600	512.0	2.257	-0.595	0.021	-0.595	0.034	-0.590
	7	-0.400	512.0	3.401	-0.399	0.033	-0.400	0.131	-0.394
	8	-0.200	512.0	2.270	-0.202	0.021	-0.202	0.038	-0.198
	9	0.000	512.0	2.443	-0.005	0.023	-0.005	0.042	-0.001
	10	0.200	512.0	2.406	0.195	0.022	0.195	0.044	0.196
	11	0.400	512.0	2.210	0.394	0.022	0.394	0.043	0.396
	12	0.600	512.0	2.210	0.593	0.022	0.593	0.045	0.595
	13	0.800	512.0	2.293	0.792	0.021	0.793	0.048	0.795
	14	1.000	512.0	2.183	0.992	0.021	0.992	0.049	0.994
	15	1.200	512.0	2.173	1.194	0.021	1.194	0.051	1.196
	16	1.414	512.0	3.271	1.407	0.026	1.405	0.229	1.418
	17	0.000	512.0	2.458	-0.003	0.022	-0.003	0.042	0.001
Free-Running Oscillator Reference	25	0.000	510.3	1.558	-0.001	0.020	-0.010	0.031	-
	26	-1.414	510.4	1.678	-1.411	0.021	-1.414	0.025	-
	27	-1.200	510.5	1.661	-1.194	0.020	-1.198	0.024	-
	28	-1.000	510.5	1.587	-0.993	0.020	-0.998	0.025	-
	29	-0.800	510.4	1.677	-0.780	0.021	-0.785	0.028	-
	30	-0.600	510.5	1.665	-0.591	0.020	-0.596	0.028	-
	31	-0.400	510.6	1.707	-0.395	0.021	-0.401	0.030	-
	32	-0.200	510.6	1.662	-0.198	0.021	-0.205	0.031	-
	33	0.000	510.6	1.708	-0.002	0.021	-0.009	0.033	-
	34	0.200	510.6	1.728	0.198	0.021	0.189	0.035	-
	35	0.400	510.5	1.674	0.397	0.021	0.389	0.035	-
	36	0.600	510.4	1.623	0.596	0.021	0.586	0.035	-
	37	0.800	510.5	1.670	0.796	0.021	0.786	0.038	-
	38	1.000	510.5	1.662	0.994	0.021	0.984	0.039	-
	39	1.200	510.6	1.681	1.196	0.020	1.186	0.041	-
40	1.414	510.6	1.671	1.409	0.020	1.398	0.042	-	
41	0.000	510.8	1.667	0.000	0.021	-0.006	0.033	-	

1. When a PLL was used there was no significant difference between the means of corresponding  $V_1$ 's and  $V_2$ 's. There was an improvement in  $\sigma$  by a factor of 1.5 to 2.5 of  $V_1$  over  $V_2$  ( $\sigma$  improvement seemed to be greater at higher than at lower data values). This reduced precision of  $V_2$  was offset by the reduced computational complexity required to calculate  $V_2$ .

2. The difference in the means of the  $V_1$ 's with and without a PLL was only 0.2 percent of full scale.

3. The distribution of  $A + B$  was tighter *without* the PLL by a factor of about 1.4. Of course the sample was taken over only 307.2 msec so that the effect on  $\sigma$  caused by low frequency or long-term changes in tape speed or by changes of the free-running oscillator frequency are not evaluated. The tighter distribution without the PLL indicates that the PLL design was insufficient to maintain a tight lock on the multiplication factor 512. This supposition was strengthened when anomalies were discovered in files 5, 7, and 16 (indicated by the large standard deviations associated with these files). It was found on analysis that in each case the bad section of data was due to a dropout in the reference channel. After each dropout, the PLL reacted like a servo system (which it is) having a natural frequency of about 1 kHz but with a very low damping constant, requiring nearly 5 msec to settle. It is known that the Model 300 DMTR has a flutter component somewhat higher than 1 kHz. This explains the inability of the PLL to maintain tight lock and thus the higher standard deviations for  $A + B$  when the PLL was used. This same condition explains the slightly increased precision of  $V_1$  when the free-running oscillator was used, an improvement by a factor of about 1.95 except for those files which contained dropouts. There the improvement was less (about 1.5) because of the inability of the free-running oscillator to "drop out". The improvement was also very pronounced in the comparison of  $V_2$ 's where an improvement by a factor of 1.25 in precision using the oscillator over the PLL was calculated except for files with reference dropouts, in which cases the improvement ranged from 4.0 to 7.0.

4. When a free-running oscillator was used the improvement in precision of  $V_1$  over  $V_2$  ranged from a factor of 1.2 to 2.1, again depending on the value of the data (higher levels demonstrated greater improvement).

5. When a free-running oscillator was used, the means of  $V_2$ 's suffered the greatest inaccuracies. This is because the equation for  $V_2$   $\left( V_2 = \frac{A - 256}{100} \right)$  was based on a multiplication of 512 which, as can be seen from the means of  $A + B$ , was not the case. If the term "256" in the equation for  $V_2$  were replaced by one-half the mean of  $A + B$ , the equation would work perfectly. Unfortunately this requires a calculation of the "instantaneous" mean of  $A + B$  to allow for widely varying tape speeds. Such a calculation is very impractical. The approach of using the  $V_2$  equation, then, is unsatisfactory.

6. The best results were obtained by calculating for  $V_1$  and using a free-running oscillator. This also permitted the resolution to be varied by arbitrarily changing the ratio of oscillator frequency to DPWM sampling rate.

7. The effect of dropouts on the reference track has already been discussed. However, dropouts can also occur on a data track. The effect is not noticeable for static levels because the data which should occur in the dropout region are not missed—3840 samples were taken regardless of gaps in the data. Since all samples are the same (static data), the absence of data points cannot be detected. This does not hold for dynamic data where missed data points result in discontinuities (recall that the read strobes which cause the computer to read counters *A* and *B* are generated by the data signal; thus no data signal, no strobes and no samples). Although the values of each datum point in a dropout is lost, it is possible to discover the number of such lost points provided the dropout is not long. Either counter *A* or counter *B* is counting at any given time. When a dropout occurs, pulses are missed in pairs for the duration of the dropout. Therefore the counter that was in operation when the dropout began continues in operation throughout the duration of the dropout. This counter will fill up once and reset for each sample missed. It is a simple matter to add more stages to the counter so that for every sample missed, the counter simply overflows into these stages. The additional stages, then, actually count the number of overflows and hence the number of samples missed. These additional stages can then be read out with the next sample, and the number of missed samples and their locations are automatically recorded.

8. The DMTR techniques were most effective with the equation for  $V_1$  and a free-running oscillator. The curve in Figure 28b shows an inaccuracy (with the exception of the data for  $-0.800 V$ ) no greater than  $\pm 0.33$  percent of full scale. In addition the combined effects of accuracy and precision gave an inaccuracy no greater than  $\pm 1$  percent of full scale, again with the exception of the data of file 29. However, the inaccuracy of file 29 recurred in every test and did not fall in line with any of the other data points. It is therefore thought to be the result of an inaccurate data input level. Even with that file included, the accuracy was  $\pm 0.71$  percent and the combined effects of accuracy and precision were only  $\pm 1.45$  percent.

9. The linearity for  $V_1$ 's as calculated from files 25–41 (free-running oscillator) was  $\pm 0.49$  percent of full-scale deviation from the best straight line. The equation for the best straight line is:

$$V_{out} = 0.994 V_{in} + 0.0015$$

Ignoring file 29, the linearity deviated no more than 0.24 percent of full scale from the best straight line.

10. The full-scale signal-to-noise ratio calculated for the  $V_1$ 's of files 25–41 was 46 dB; for  $V_2$ 's of files 25–41, 40 dB; for  $V_1$ 's of files 1–17, 44 dB; and for  $V_2$ 's of files 1–17, it was 38 dB when dropouts were ignored and 25 dB where they were taken into account.

To summarize the digital evaluation of the static levels (files 1–17 and 25–41), it is concluded that excellent results can be achieved when the voltages are calculated from the samples by the equation for  $V_1$  and when a stable, free-running oscillator is used with the digital electronics. The oscillator should be closely set to the desired multiplication factor ,

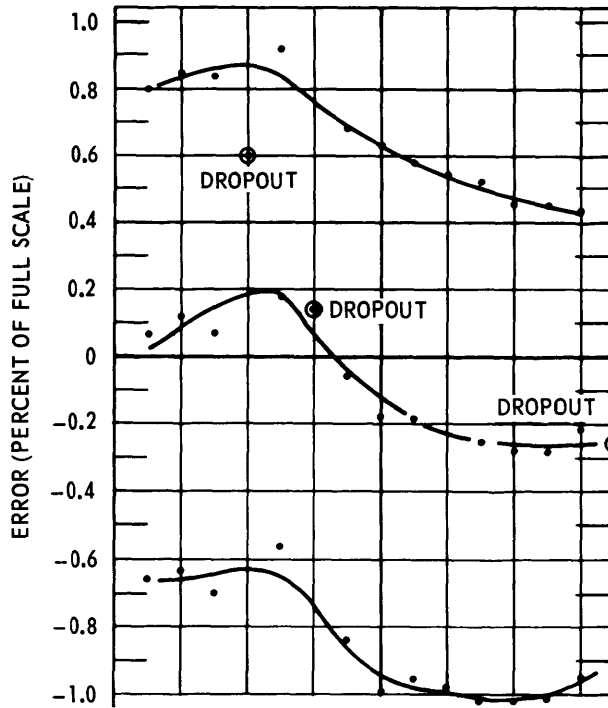

Figure 28a - Files 1-17 (with Phase-Locked Loop)  
 (Points with Dropouts are not Included in Error Band)

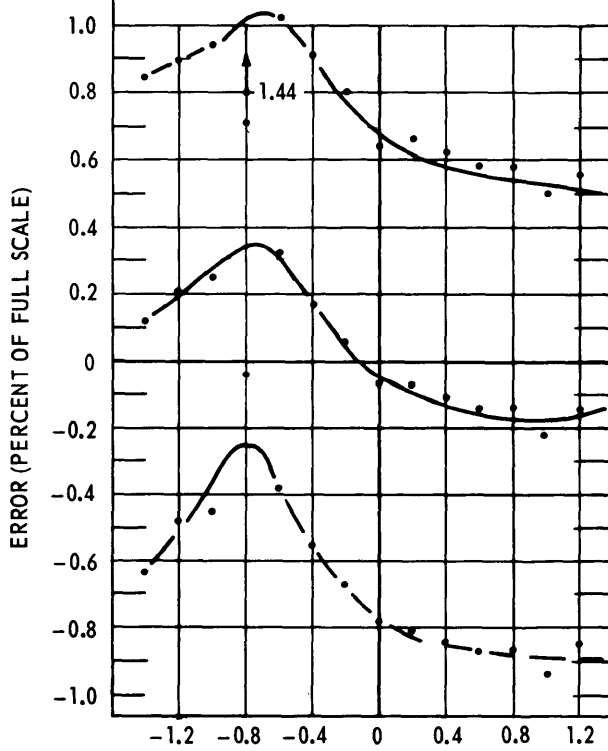

Figure 28b - Files 25-41 (with Free-Running Oscillator)

Figure 28 - Error Curves for  $v_1$  with and without a Phase-Locked Loop

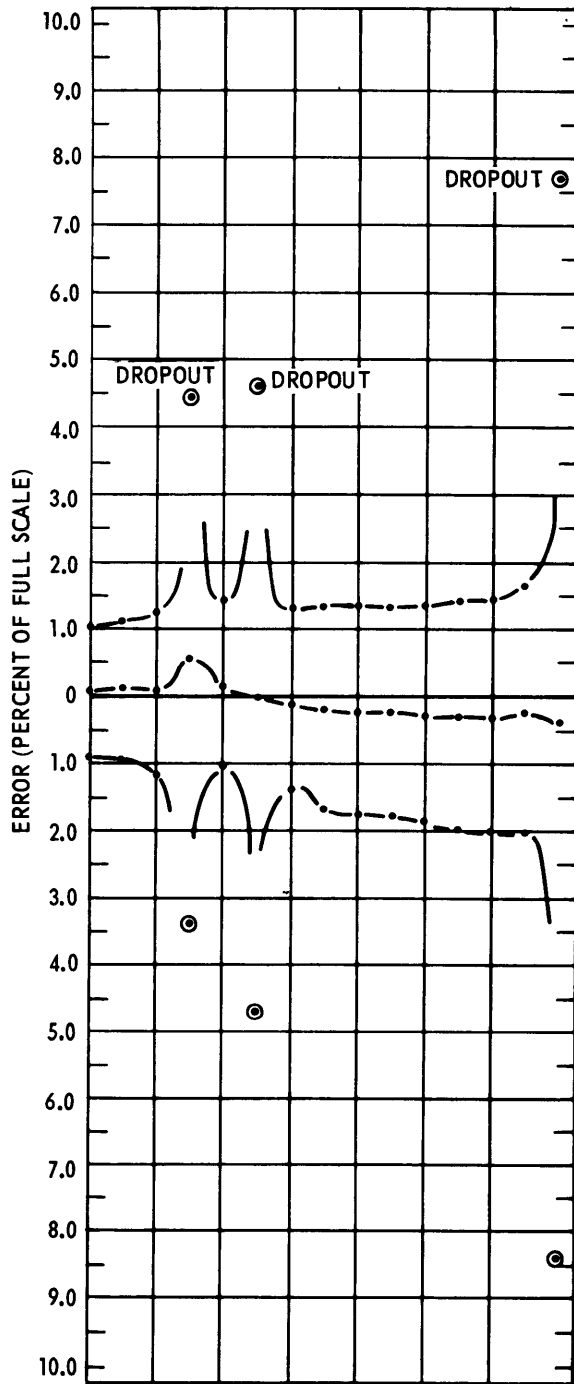

Figure 29 – Error Curve for  $v_2$  Using a Phase-Locked Loop

thus establishing the resolution, The following performance was measured by using data taken under these conditions and a multiplication factor of 512:

Accuracy	$\pm 0.71$ percent of full scale
Linearity	$\pm 0.49$ percent of full scale
Full Scale S/N Ratio	46 dB
Precision	$\pm 0.74$ percent of full scale (3 $\sigma$ significance)

The dynamic data (files 18–24 and 42–48) are a series of single-frequency sine waves. Each file of a group contains a different frequency from each of the others of a group. These frequencies range from 10 Hz at the low frequency end to 3 kHz at the high end. The frequency in each file is:

File Numbers	Content (Hz)
18,42	10
19,43	100
20,44	500
21,45	1000
22,46	2000
23,47	2500
24,48	3000

Little more could be economically learned from the dynamic data over what was learned from the static. However portions of the files were plotted by the CDC 6700. The plots for  $V_1$  and  $V_2$  of files 42 and 43 are presented in Figures 30–33. Note the improvement in  $S/N$  of  $V_2$  over  $V_1$  in each case. In addition, Appendix C tabulates the distributions of the data points of each file for both  $V_1$  and  $V_2$  and gives a few graphically as well. The distributions show the characteristic arcsin shape expected from sampled sinusoids. No unusual anomalies were discovered.

It should be noted that the 50-mV offset present in the sinusoid displays was present in the original signal and was not introduced by the DMTR signal or the evaluation techniques.

## OTHER USES OF THE CONCEPTS

Mention should be made of other uses for the concepts described herein. By far the most utilitarian application thus far devised for DPWM is the DMTR described in this report. This use can be extended to other types of tape recording devices. Small portable devices such as cassette and cartridge recorders are candidates for prime consideration. The large variations in tape speed that accompany battery operation will cause no problem if DPWM techniques are used. The possibility even exists for a “shirt pocket-sized” instrumentation recorder.

Another technique has been developed to allow the multiplexing of two or more PWM signals into a single DPWM signal, thus increasing the channel capacity.

Portions of the circuitry can be used in other applications. For instance, an accurate analog-to-digital converter can easily be developed by using the circuits of the triangle

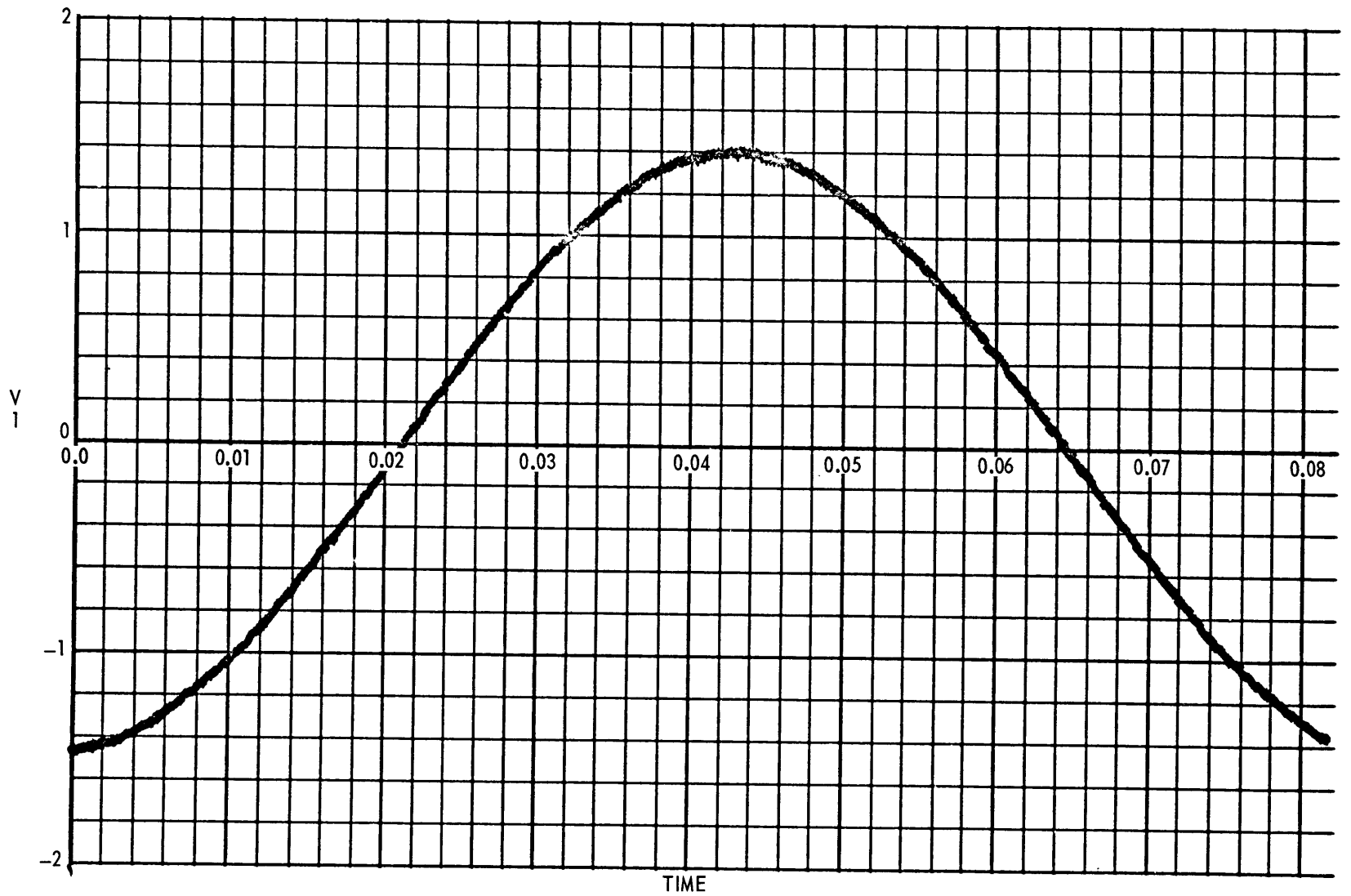

Figure 30 - Partial Computer Plot of File 42 Showing  $v_1$  Points for 10-Hz Sine Wave



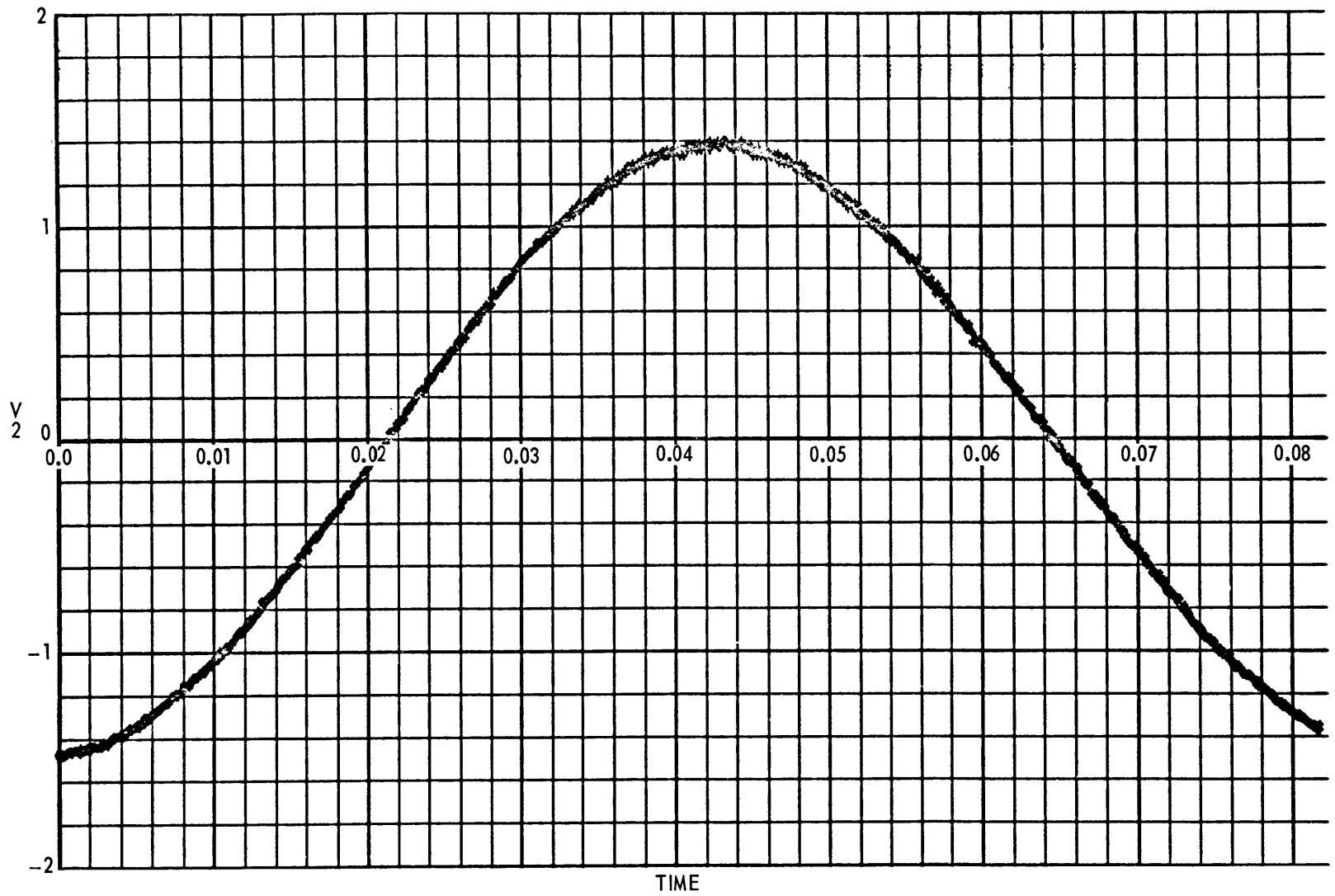

Figure 31 – Partial Computer Plot of File 42 Showing  $v_2$  Points for 10-Hz Sine Wave

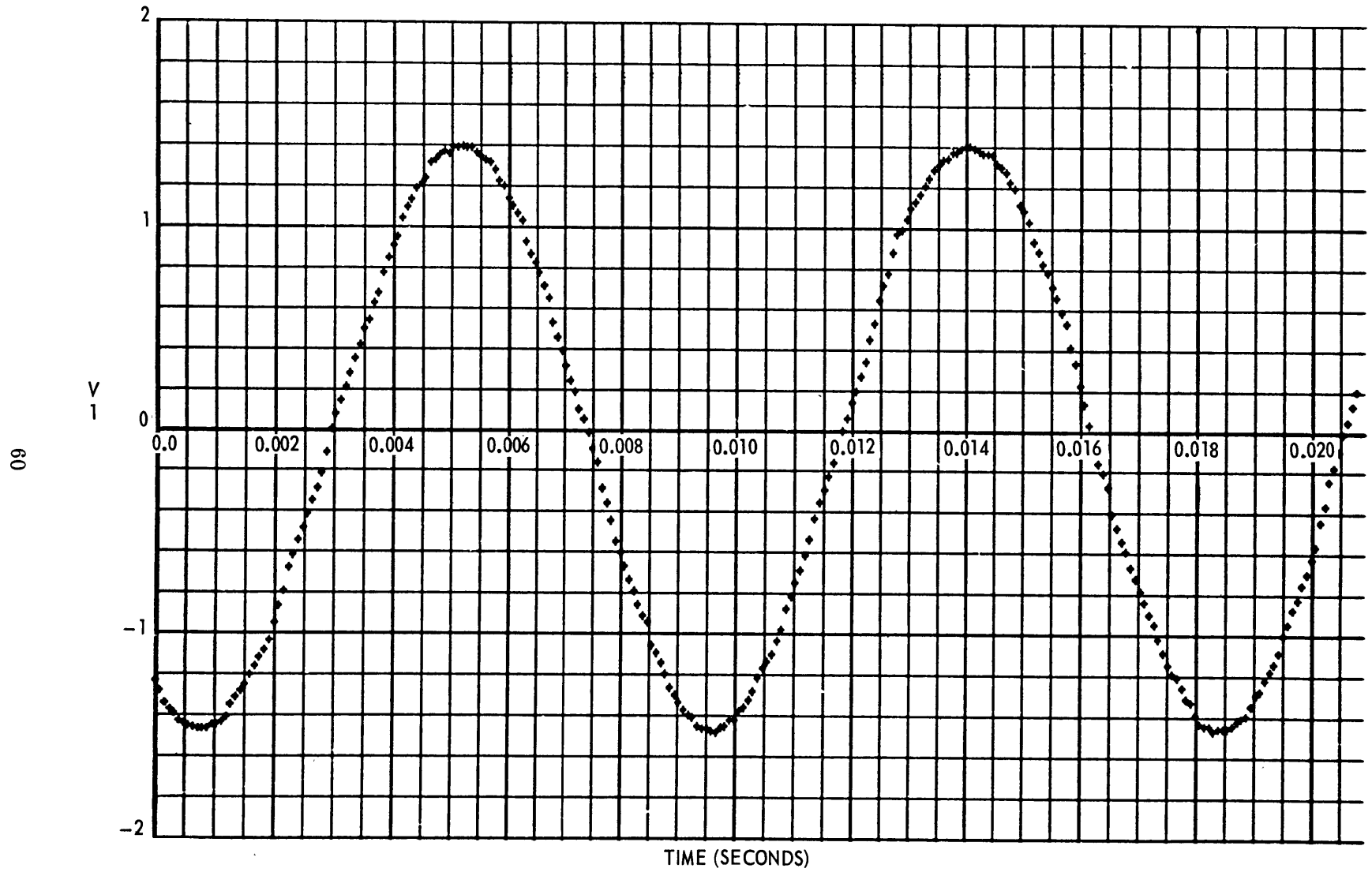

Figure 32 – Partial Computer Plot of File 43 Showing  $v_1$  Points for 100-Hz Sine Wave

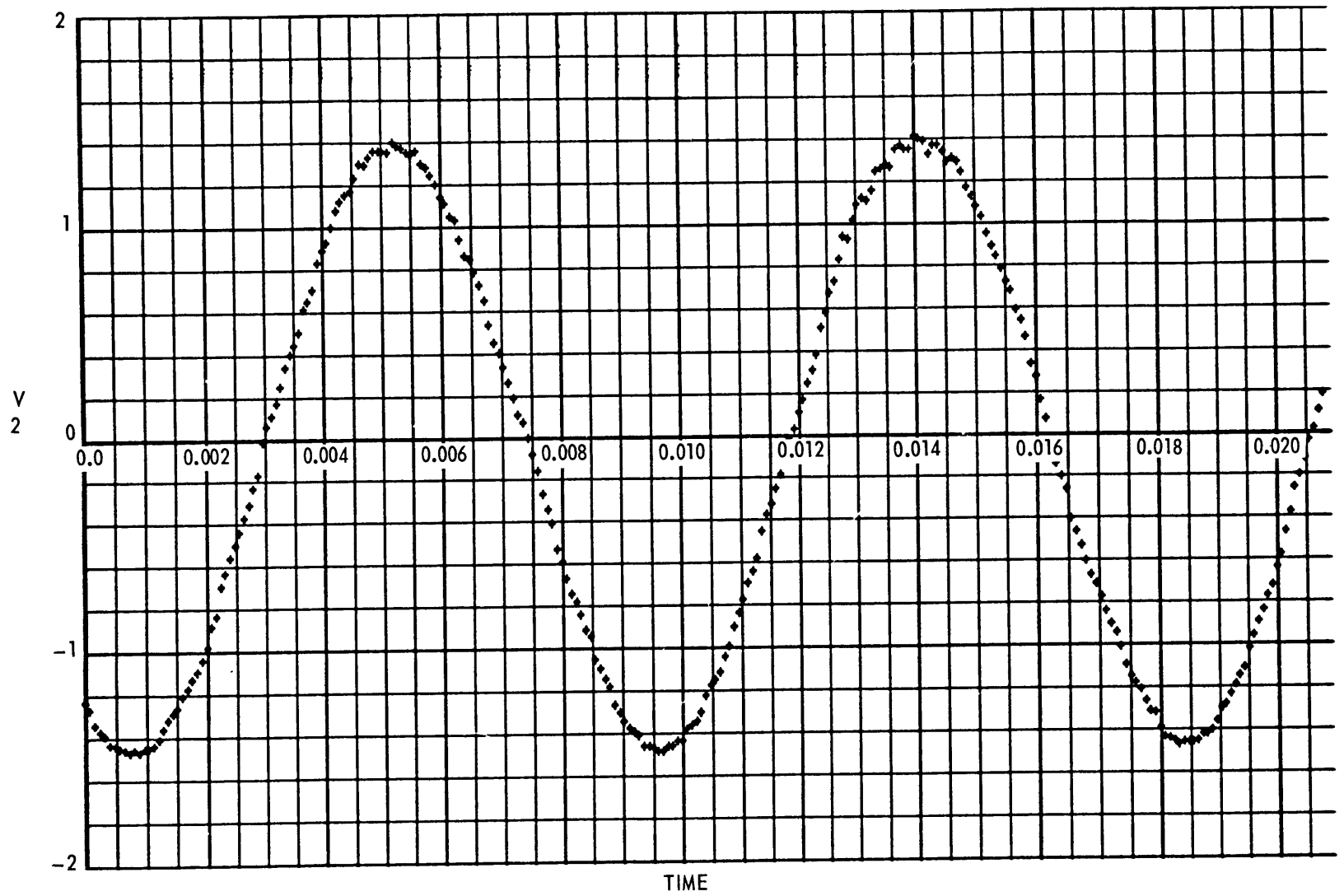

Figure 33 - Partial Computer Plot of File 43 Showing  $v_2$  Points for 100-Hz Sine Wave

generator, record card (comparator and input stages), and the phase-locked loop and counters. As in the tape recorder, sampling rate and precision could easily be changed to meet different needs. The raw DPWM signals rather than their digital equivalents can also be telemetered from remote locations, thus reducing the required bandwidths.

## RECOMMENDATIONS

1. The additional digital bit rate required presently hampers increasing the "digital bandwidth" of the recorder. Therefore techniques should be developed to extend this bandwidth for both analog and digital outputs.
2. Methods for more direct access to high-speed digital computers than that used in this development should be investigated in order to further reduce data reduction time, the amount of equipment involved, and hence the cost.
3. A production development program should be initiated to refine the tape recorder properties (possibly conducted by commercial concerns).

## ACKNOWLEDGMENTS

A mere acknowledgment is insufficient to express the invaluable effort expended on this program by Mr. George Cook. It is he who was initially responsible for the DMTR concept. Until Mr. Cook's retirement in 1969, the author worked in this program under the steady influence of his most capable guidance. Were it not for his innovative nature, his discontent with the "status quo," and his extensive foresight, the continuing development of the tape recorder might never have occurred.

An expression of gratitude is due Mr. Dave Milne of the Central Instrumentation Department for his help in the solution of tricky circuit problems on numerous occasions. Mr. Milne is also primarily responsible for the development of the DSID circuitry.

Finally, the author acknowledges the efforts of Mr. Jack Gordon of the Ship Performance Department who provided and developed the software for the Interdata Model IV minicomputer and those of Messrs. Ralph Johnson and Richard Sigman of the Computation and Mathematics Department who developed the techniques and software for the digital analysis on the CDC 6700 computer.

## APPENDIX A

### CONSIDERATIONS OF DPWM STIMULATED BY STATIC AND DYNAMIC DATA

Differential pulse width modulation (DPWM) is a sampling technique for data conversion. The data to be sampled  $v_m$  are compared (in amplitude) to a triangular voltage  $v_r$ . From this comparison, a rectangular wave  $v_c$  is formed. The data are stored in this rectangular wave as a function of its symmetry. Because the rectangular wave is generated from a comparison of the data with the reference triangular wave, and if the data amplitude is always kept smaller in magnitude and frequency than the triangular wave,

$$|v_m| < |v_r| \quad \text{[A-1]}$$

$$f_m < f_r \quad \text{[A-2]}$$

the resultant DPWM signal will have an average frequency  $f_c$  equal to  $f_r$ . If  $v_m$  is allowed the same amplitude range as  $v_r$ , then the symmetry  $P$  will have the range 0 percent  $< P <$  100 percent. Furthermore if  $v_r$  is symmetrical about the abscissa or time axis (i.e., its positive and negative amplitudes are equal in magnitude), then  $P = 50$  percent for  $v_m = 0$ .

The DPWM signal is shown in Figure A-1. as  $v_m$  changes, the pulse width  $t_y - t_x$  changes proportionally. Also  $t_z$  changes as a result of the pulse width change of the next sample located at  $t = 2\pi$ . If  $v_m$  and  $v_r$  are normalized so that  $-1 \leq v_r \leq 1$  and  $-1 < v_m < 1$ , then a table of values for  $v_m, t_x, t_y, t_z$  can be made:

$v_m$	$t_x$	$t_y$	$t_z$
-1	0	0	$2\pi$
0	$-\pi/2$	$\pi/2$	$3\pi/2$
1	$-\pi$	$\pi$	$\pi$

The following relationships result

$$t_x = -\frac{v_m + 1}{2} \pi \quad \text{[A-3]}$$

$$t_y = \frac{v_m + 1}{2} \pi \quad \text{[A-4]}$$

$$t_z = \frac{3 - v_m}{2} \pi \quad \text{[A-5]}$$

The Fourier series for a DPWM signal resulting from static stimuli can be found from this information. Because even function symmetry exists,  $f(t) = f(-t)$ , the sine coefficients are zero,  $b_n = 0$ . Therefore  $a_0$ , the steady state term, and  $a_n$ , the cosine coefficients are all that are required.<sup>1</sup>

---

<sup>1</sup>Goldman, S. A., "Frequency Analysis, Modulation, and Noise," McGraw-Hill Book Company Inc., New York (1948) Chapters 1,2, and 5.

$$\begin{aligned}
a_o &= \frac{1}{T} \int_0^T f(t) dt \\
&= \frac{1}{2\pi} \int_{t_x}^{t_y} (1) dt + \frac{1}{2\pi} \int_{t_y}^{t_z} (-1) dt \\
&= \frac{1}{2\pi} \int_{-\frac{v_m+1}{2}\pi}^{\frac{v_m+1}{2}\pi} dt - \frac{1}{2\pi} \int_{\frac{v_m+1}{2}\pi}^{\frac{3-v_m}{2}\pi} dt
\end{aligned}$$

$$a_o = v_m$$

[A-6]

$$a_n = \frac{2}{T} \int_0^T f(t) \cos n\omega_c t dt \quad \left[ \omega_c = 2\pi/T = 1 \right]$$

$$= \frac{1}{\pi} \int_{t_x}^{t_z} f(t) \cos nt dt$$

$$= \frac{1}{\pi} \int_{-\frac{v_m+1}{2}\pi}^{\frac{v_m+1}{2}\pi} \cos nt dt - \frac{1}{\pi} \int_{\frac{v_m+1}{2}\pi}^{\frac{3-v_m}{2}\pi} \cos nt dt$$

$$= \frac{1}{\pi} \left[ \frac{\sin n \left( \frac{v_m+1}{2} \pi \right)}{n} - \frac{\sin n \left( -\frac{v_m+1}{2} \pi \right)}{n} - \frac{\sin n \left( \frac{3-v_m}{2} \pi \right)}{n} + \frac{\sin n \left( \frac{v_m+1}{2} \pi \right)}{n} \right]$$

$$= \frac{4}{n\pi} \left[ \sin n \left( \frac{v_m+1}{2} \pi \right) \right]$$

$$= \frac{4}{n\pi} \left[ \sin \frac{nv_m}{2} \pi \cos \frac{n\pi}{2} + \cos \frac{nv_m}{2} \pi \sin \frac{n\pi}{2} \right]$$

$$a_n = \begin{cases} \frac{4}{n\pi} (-1)^{\frac{n}{2}} \sin \left( \frac{nv_m}{2} \pi \right) & \text{for } n \text{ even} \\ \frac{4}{n\pi} (-1)^{\frac{n-1}{2}} \cos \left( \frac{nv_m}{2} \pi \right) & \text{for } n \text{ odd} \end{cases}$$

[A-7]

By translating angles and combining the two terms of the coefficient the complete series is found to be:

$$f(t) = v_m + \frac{4}{n\pi} \sin n \left( \frac{v_m+1}{2} \right) \pi \cos nt \quad \text{[A-8]}$$

which can be expanded to

$$f(t) = v_m + \frac{4}{\pi} \cos \frac{v_m}{2} \pi \cos t - \frac{2}{\pi} \sin v_m \pi \cos 2t - \frac{4}{3\pi} \cos \frac{3v_m}{2} \pi \cos 3t + \dots$$

Clearly the data  $v_m$  can be simply retrieved with a low-pass filter whose cutoff frequency lies below the normalized fundamental frequency  $\omega_c = 1$ .

The situation is modified somewhat if  $v_m$  is dynamic in nature. Again assume that  $-1 < v_m < 1$ . For any data source  $v_m(t)$ , the pulse width is assumed to have the form

$$\Delta t = \frac{T}{2} + \frac{T}{2} v_m(t) = \frac{T}{2} [1 + v_m(t)] \quad [\text{A-9}]$$

where  $T$  (the sampling period)  $\leq \frac{1}{5f_m}$ . A mathematical expression for the sampling function  $f_s(t)$  can be derived as follows from Figure A-2:

$$c_n = \int_{t_1}^{t_2} e^{-jn\omega_o t} dt = \frac{1}{n\omega_o} \left( \frac{e^{-jn\omega_o t_2} - e^{-jn\omega_o t_1}}{-j} \right)$$

Substituting  $t_2 = t_1 + \Delta t$

$$c_n = \frac{1}{n\omega_o} e^{-jn\omega_o t_1} \left[ \frac{e^{-jn\omega_o \Delta t} - 1}{-j} \right] \quad [\text{A-10}]$$

By factoring out of the bracket the term

$$\begin{aligned} & e^{-jn\omega_o \frac{\Delta t}{2}} \\ c_n &= \frac{1}{n\omega_o} e^{-jn\omega_o t_1} e^{-jn\omega_o \frac{\Delta t}{2}} \left[ \frac{e^{-jn\omega_o \frac{\Delta t}{2}} - e^{jn\omega_o \frac{\Delta t}{2}}}{-j} \right] \\ &= \frac{2}{n\omega_o} e^{-jn\omega_o \left( t_1 + \frac{\Delta t}{2} \right)} \left[ \frac{e^{jn\omega_o \frac{\Delta t}{2}} - e^{-jn\omega_o \frac{\Delta t}{2}}}{2j} \right] \end{aligned}$$

Recognizing that  $t_1 + \frac{\Delta t}{2} = 0$  and that

$$\begin{aligned} & \frac{e^{jn\omega_o \frac{\Delta t}{2}} - e^{-jn\omega_o \frac{\Delta t}{2}}}{2j} = \sin n\omega_o \frac{\Delta t}{2} \\ c_n &= \frac{2}{n\omega_o} \sin n\omega_o \frac{\Delta t}{2} = \Delta t \frac{\sin n\omega_o \frac{\Delta t}{2}}{n\omega_o \frac{\Delta t}{2}} \quad [\text{A-11}] \end{aligned}$$

From the exponential form of the Fourier series

$$f_s(t) = \frac{1}{T} \sum_{n=-\infty}^{\infty} c_n e^{jn\omega_o t}$$

$$f_s(t) = \frac{\Delta t}{T} \sum_{n=-\infty}^{\infty} \frac{\sin n\omega_o \frac{\Delta t}{2}}{n\omega_o \frac{\Delta t}{2}} e^{jn\omega_o t} \quad [\text{A-12}]$$

By extracting the term for  $n = 0$  and combining terms for positive and negative  $n$ , the following is obtained:

$$f_s(t) = \frac{\Delta t}{T} + \frac{\Delta t}{T} \sum_{n=1}^{\infty} \left[ \frac{\sin n\omega_o \frac{\Delta t}{2}}{n\omega_o \frac{\Delta t}{2}} e^{jn\omega_o t} - \frac{\sin -n\omega_o \frac{\Delta t}{2}}{n\omega_o \frac{\Delta t}{2}} e^{-jn\omega_o t} \right]$$

$$= \frac{\Delta t}{T} + \frac{\Delta t}{T} \sum_{n=1}^{\infty} \frac{2 \sin n\omega_o \frac{\Delta t}{2}}{n\omega_o \frac{\Delta t}{2}} \left( \frac{e^{jn\omega_o t} + e^{-jn\omega_o t}}{2} \right)$$

$$= \frac{\Delta t}{T} + 2 \sum_{n=1}^{\infty} \frac{\Delta t}{T} \frac{\sin n\omega_o \frac{\Delta t}{2}}{n\omega_o \frac{\Delta t}{2}} \cos n\omega_o t \quad [\text{A-13}]$$

Substituting from Equation [A-9] for  $\Delta t$  the expression for the DPWM signal  $v_c(t)$ , results:

$$v_c(t) = \frac{\frac{T}{2} [1 + v_m(t)]}{T} + 2 \sum_{n=1}^{\infty} \frac{\Delta t}{T} \frac{\sin n\omega_o \frac{\Delta t}{2}}{n\omega_o \frac{\Delta t}{2}} \cos n\omega_o t$$

$$v_c(t) = \frac{1}{2} + \frac{v_m(t)}{2} + 2 \sum_{n=1}^{\infty} \frac{\Delta t}{T} \frac{\sin n\omega_o \frac{\Delta t}{2}}{n\omega_o \frac{\Delta t}{2}} \cos n\omega_o t \quad [\text{A-14}]$$

The first term of Equation [A-14], a d-c level, is a consequence of the amplitude nonsymmetry of  $f_s(t)$ . The second term contains the data and has a bandwidth equal to the data. The third term represents frequency components about  $n\omega_o$  and will thus be rejected by a low-pass filter having a bandwidth equal to that of  $v_m(t)$ .<sup>2</sup> Therefore, the data can be recovered with a low-pass filter.

<sup>2</sup>Hancock, F. C., "Introduction to The Principles of Communication Theory," McGraw-Hill Book Company, Inc., New York (1961) Chapters 1 and 2.



The foregoing described a method of reducing the DPWM to the original analog form of the modulating signal. Because of the nature of the DPWM, the contained information can also be extracted digitally by one of several suitable methods. Basically, each process measures the pulse width or symmetry of each DPWM sample in some manner.

The digitizing process, however, implies that a single value accurately represents each sample. This is not the case for sampled dynamic data. The sample lacks derivation (or rate) information and is therefore of less value than an analog sample taken at the same time. The analog techniques yield the necessary derivative information for the data during the time  $\Delta t$ . Furthermore a value obtained digitally implies that a sample was taken in zero time which is clearly not the case. Thus the digital process spreads the zero-time sample out over the sample period  $\Delta t$ . This is the same as converting an impulse into a pulse of width  $\Delta t$ . A network which performs that conversion has a  $\frac{\sin x}{x}$  transfer function. The digital process has the same effect as passing the original data signal through a low-pass filter with a  $\frac{\sin x}{x}$  characteristic. The first zero would occur at  $1/\Delta t$ . Thus in the DPWM for small  $\Delta t$  (low data voltage) the bandwidth is large whereas for large  $\Delta t$ , the first zero occurs at lower frequency.

A simple example should further clarify the effect. Let the data take the form of a ramp

$$v_m = m_m t + v_o \quad [\text{A-15}]$$

where  $v_o$  is the ordinate intercept. Figure A-3 shows this function as it intersects the carrier signal  $v_c$ .

The carrier function is defined as

$$v_c^- = -m_c t - A, \quad -\pi \leq t \leq 0 \quad [\text{A-16}]$$

$$v_c^+ = m_c t - A, \quad 0 < t \leq \pi$$

The intersection of  $v_m$  with  $v_c^-$  is

$$t^- = -\frac{(v_o + A)}{m_m + m_c} \quad [\text{A-17}]$$

and the intersection of  $v_m$  with  $v_c^+$  is

$$t^+ = -\frac{(v_o + A)}{m_m - m_c} \quad [\text{A-18}]$$

The center of the resultant DPWM pulse  $t_{p.c.}$  is

$$t_{p.c.} = \frac{t^+ + t^-}{2} = \frac{m_m (v_o + A)}{m_c^2 - m_m^2}$$

This represents the time error; i.e., the pulse is actually centered at  $t = t_{p.c.}$ , not  $t = 0$ .

This is equivalent to

$$v_m|_{t_{p.c.}} = \frac{m_m^2 (v_o + A)}{m_c^2 - m_m^2} + v_o$$

or an error  $\epsilon$  equal to  $v_m|_{t_{p.c.}} - v_o$ :

$$\epsilon = \frac{m_m^2 (v_o + A)}{m_c^2 - m_m^2} \quad [\text{A-19}]$$

Thus the error is zero when either  $m_m = 0$  or  $v_o = -A$ . Also, the greater the number of samples taken per cycle of data, the greater will be the denominator  $m_c^2 - m_m^2$  and the smaller the

error. Under the restriction  $m_m \leq \frac{m_c}{5}$ , the maximum possible error is ( $v_o = A$ ):

$$\epsilon_{\max} = \frac{m_c^2/25 (2A)}{m_c^2 - m_c^2/25} = \frac{m_c^2 (2A)}{24m_c^2}$$

$$\epsilon_{\max} = \frac{A}{12} \quad [\text{A-20}]$$

The above error is extreme, however, because  $m_m = m_c/5$  and  $v_o = A$  cannot occur simultaneously. When this is taken into consideration, a recalculation shows that the actual maximum error is  $\frac{A}{15}$ . This represents approximately a 3.3-percent error at the upper frequencies. Further restrictions are usually made to limit the amplitude of  $v_m$  to  $A/2$ . This further reduces the maximum uncorrected error to about 2.3 percent.

Error can be further reduced mathematically in the digital computer to about 1 percent. Refer to the computer program of Appendix B. Thus the DPWM can be digitally reduced with a fixed time base to an amplitude accuracy on the order of 1 percent. This makes the DPWM digital demodulation scheme ideally suited for real-time data spectrum analysis.

It should be kept in mind that as with any sampling system, the input data for DPWM must be band limited to prevent aliases of higher frequencies from appearing. This is also important in order to prevent higher order spectra signals from being folded into the original spectrum.

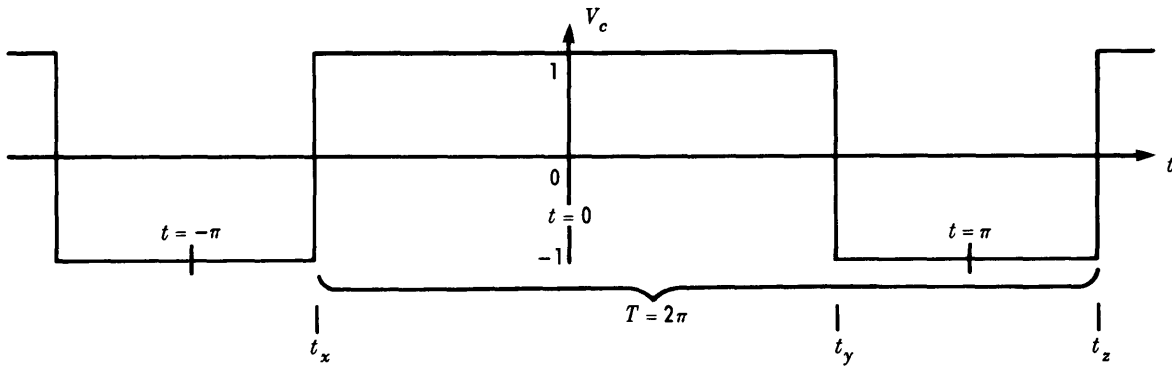

Figure A1 – Normalized Differential Pulse Width Modulation Sample

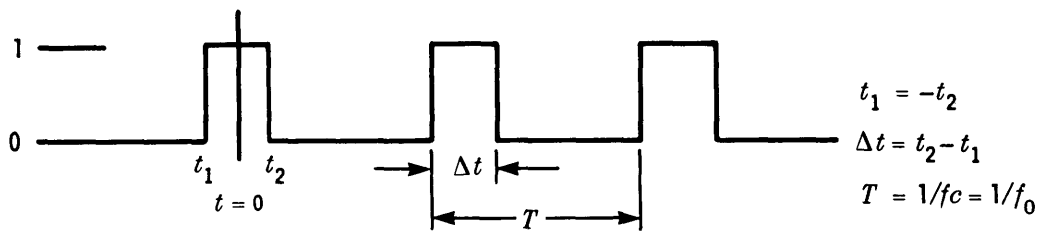

Figure A2 – The Sampling Function

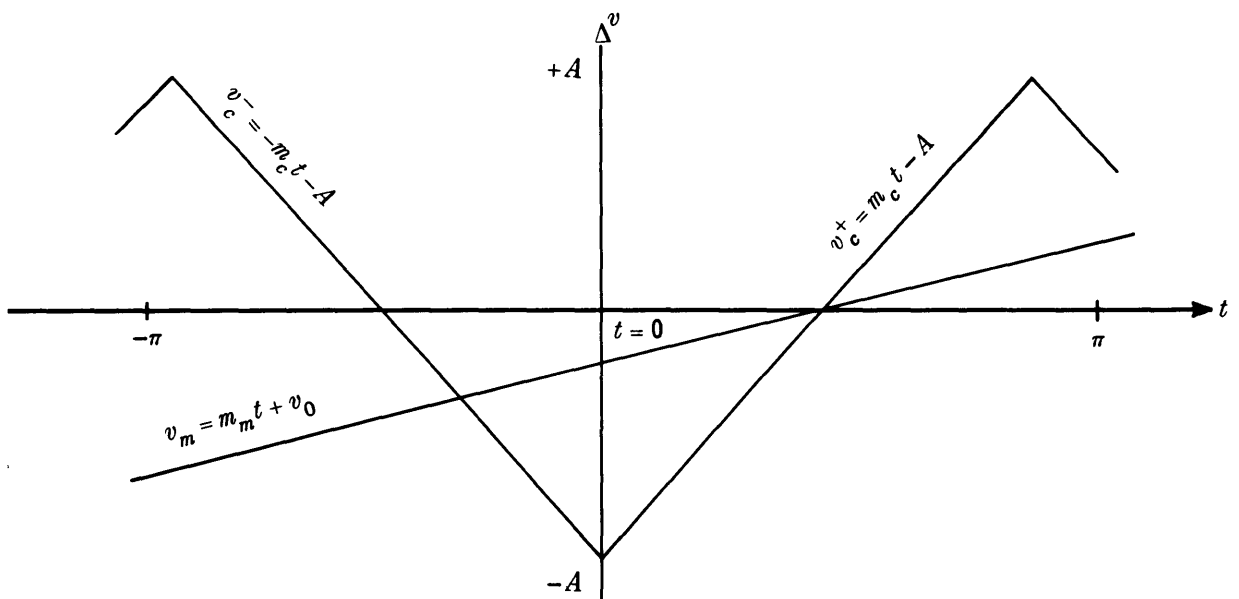

Figure A3 – Intersection of a Ramp with Differential Pulse Width Modulation Triangular Carrier



## APPENDIX B

### DIGITAL INTERFACING TECHNIQUES (HARDWARE AND SOFTWARE) USED WITH THE DMTR MODEL 300

Two digital computers were used in the digital evaluation of Model 300. The initial manipulation was performed on an Interdata Model IV minicomputer. The Model 300 DMTR output was wired to the Interdata input, thus enabling direct data transfer. The Interdata Model IV coded and reformatted the data into a configuration suitable for use in the CDC 6700 general purpose computer. The reformed data were then put on nine-track magnetic tape. This tape was used to provide input to the CDC 6700, which actually performed the data analysis.

#### INTERDATA MODEL IV

The configuration consisted of an Interdata Model IV computer with 16K of memory, one half-word I/O module, one Kennedy I/O module, and one Kennedy Model 3110 nine-track tape deck. Because the data samples from the Model 300 consisted of two nine-bit words (*A* and *B*), a modification was required to the half-word I/O module which normally accepts 16 bits of data in two eight-bit groups. The READ BLOCK instruction was used which provides the high transfer rate required (150 kHz). Eighteen bits make up a DMTR SAMPLE (two nine-bit words), and a 24-bit input capability was established by the I/O module modification. The surplus bits were filled with a code which enabled the CDC 6700 to recombine the eight-bit words received from the nine-track tape in the proper order. A complete sample has the following format:

#### BIT POSITION

1	2	3	4	5	6	7	8	
$2^8$	$2^7$	$2^6$	$2^5$	$2^4$	$2^3$	$2^2$	$2^1$	- $A_1$
0	0	0	0	0	0	$2^0$	1	- $A_2$
$2^8$	$2^7$	$2^6$	$2^5$	$2^4$	$2^3$	$2^2$	$2^1$	- $B_1$
0	0	0	0	0	0	$2^0$	0	- $B_2$

Each *A* and *B* was broken into two halves:  $A_1$  and  $A_2$ ,  $B_1$  and  $B_2$ . Data bits were loaded into all locations of  $A_1$  as shown and the least significant *A* bit into location 7 of  $A_2$ . The zeros of locations 1 through 6 of  $A_2$  and  $B_2$  are used to indicate the subscript 2 since data of such a low value cannot occur. Location 8 of the same lines which contain the zeros reveals whether the datum is an *A* or *B* value. Thus each pair of eight-bit words is identifiable and decodable.

Each sample requires four memory locations. Thus (after some memory is set aside for program storage) 3840 samples of data were stored at a time. These 3840 samples, constituting a file, were then read onto the nine-track tape in four equal records of 960 samples. All files were generated identically.

### CDC 6700 COMPUTER

The nine-track tape containing 48 files was loaded on the CDC 6700 general purpose computer. Each file was unpacked into 60-bit CDC 6700 words. Thus each 60-bit word consisted of 7 1/2 eight-bit bytes (one track of the nine-track tape was reserved for parity, leaving eight data bits). After unpacking, the coding included with the data was searched to establish the proper starting point. That is, data must be read in order starting with  $A_1$ , then  $A_2, B_1, B_2$ , and so forth. After the entire file had been unpacked, a listing of all  $A$ 's and all  $B$ 's in a file, and a histogram (distribution) of  $A + B$  were printed for record purposes. For each  $A, B$  pair voltages  $v_1$  and  $v_2$  were calculated as follows:

$$v_1 = \frac{\frac{512 A}{A + B} - 256}{100}$$

$$v_2 = \frac{A - 256}{100}$$

These voltages (3840 each) were then printed out. Each file was similarly unpacked and printed. During execution of the program, certain statistics are calculated for each file: the number of  $A, B$  pairs  $n_{A + B}$ ,  $\overline{A + B}$ ,  $\sigma_{A + B}$ ,  $\overline{v_1}$ ,  $\sigma_1$ ,  $3\sigma_1$ ,  $\overline{v_2}$ ,  $\sigma_2$ , and  $3\sigma_2$ . These statistics are also printed with the file voltage listings.

The following are printed for each record of data processed: (1) a message disclosing whether all, part, or none of the record was used in the voltage calculations and (2) the first eight 60-bit words of unpacked data. For each file processed, the printed output includes: (1) tabular listing of the  $A$ 's and  $B$ 's, (2) histogram of  $A + B$ , (3) mean and standard deviation of  $A + B$ , (4) tabular listing of  $v_1$ 's and  $v_2$ 's, and (5) means, standard deviations, and three standard deviations of  $v_1$  and  $v_2$ . These data are summarized on the last printed page.

## APPENDIX C

### DISTRIBUTIONS OF DYNAMIC DATA POINTS FROM DIGITAL EVALUATION BY CDC 6700 COMPUTER

Distributions of dynamic data points from digital evaluation of files 18–24 and 42–48 by the CDC 6700 computer are shown on the following graphs. The distribution graphs are plotted from the TOTAL columns of the computer printout sheets. The slight distribution irregularity which can be noticed in many of the plots near  $-0.6 V$  correlates with the error curves of Figure 29.

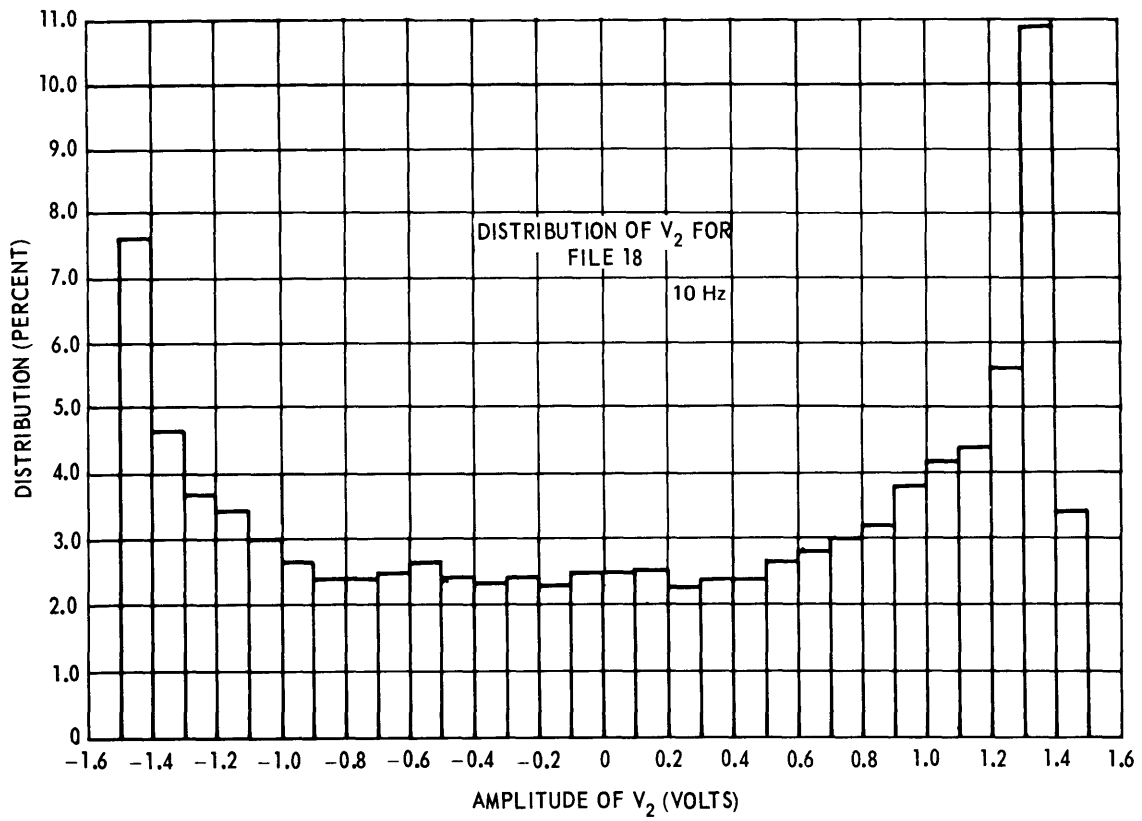
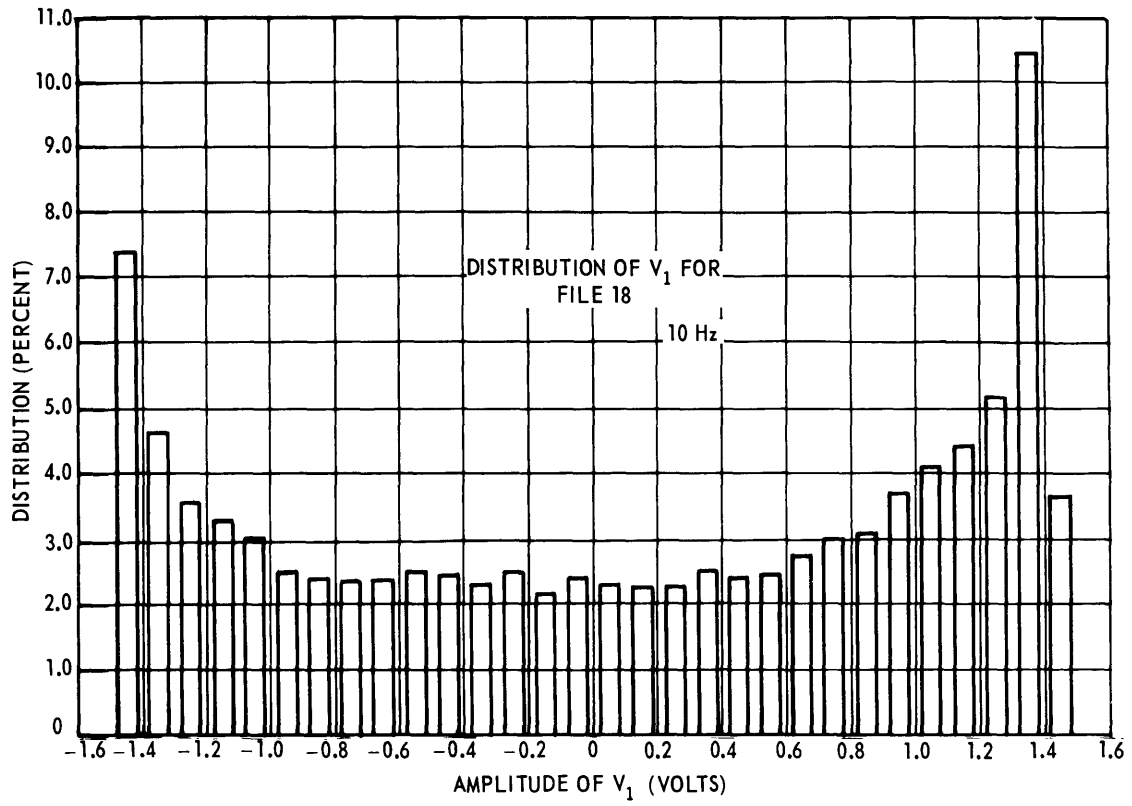



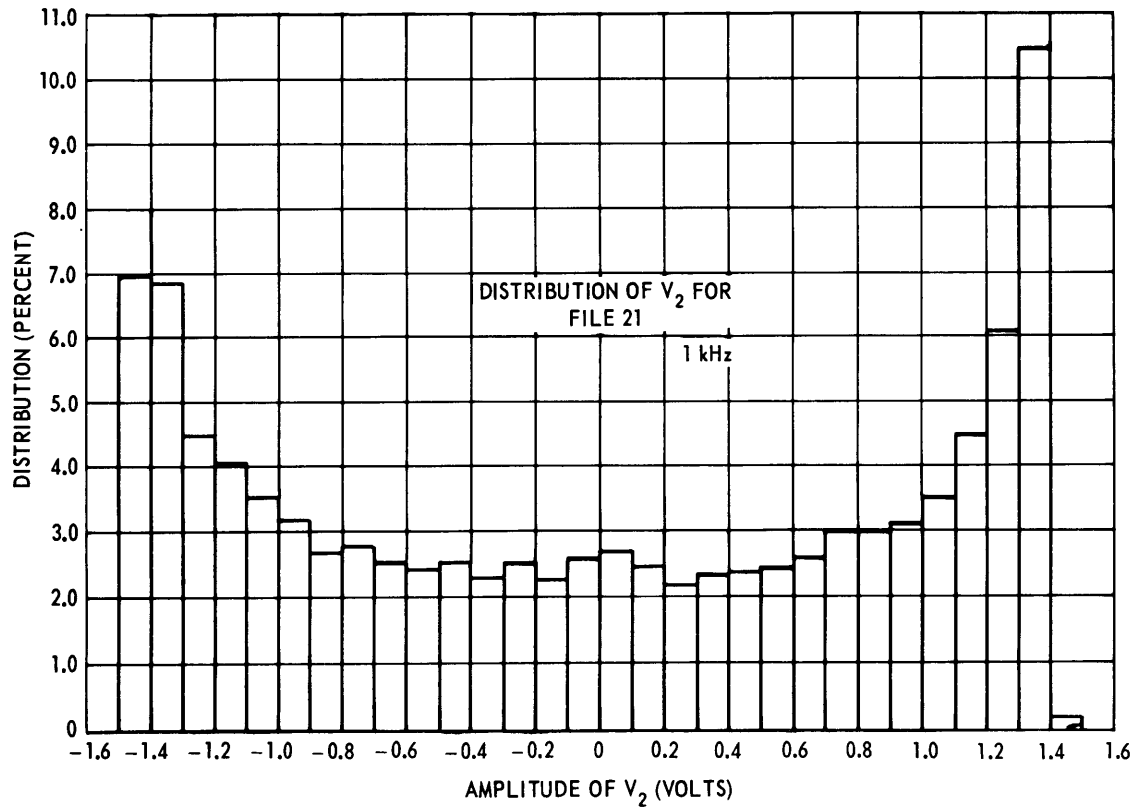
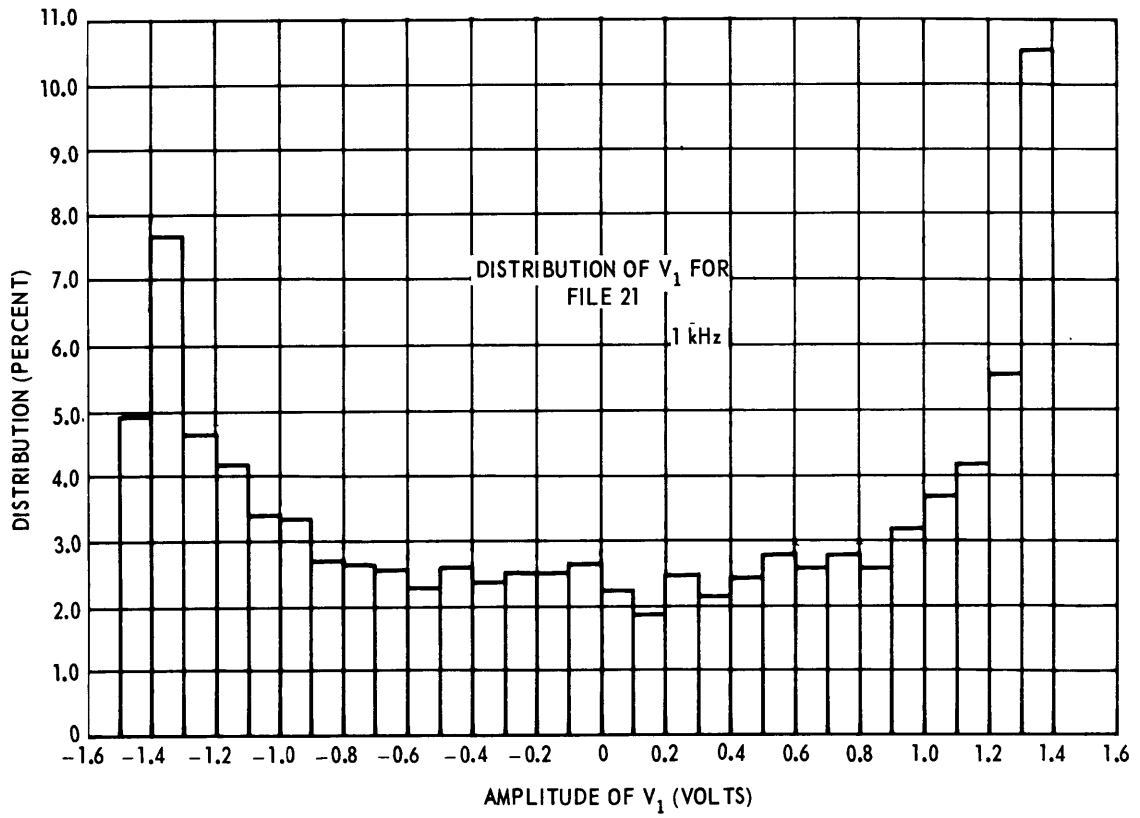

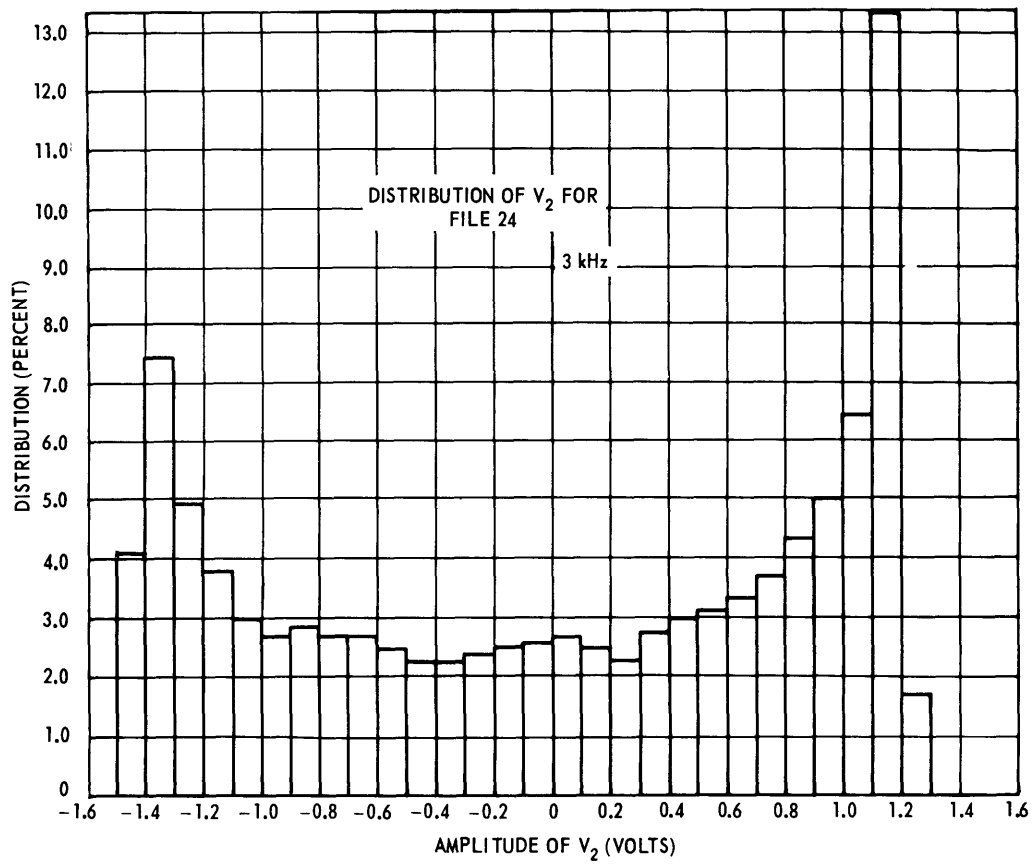
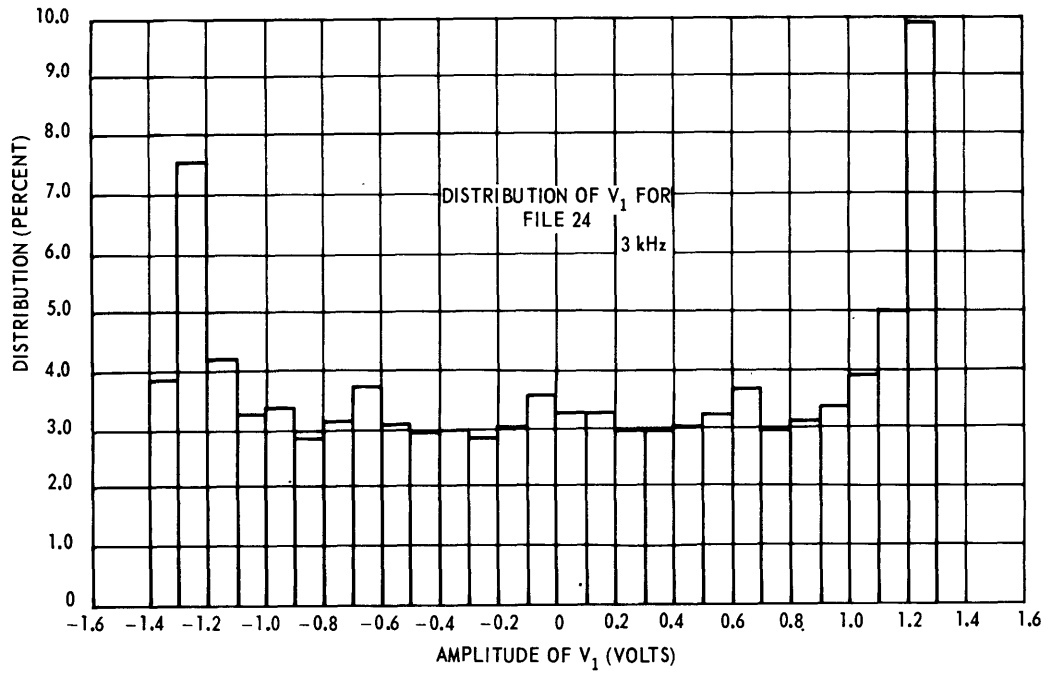

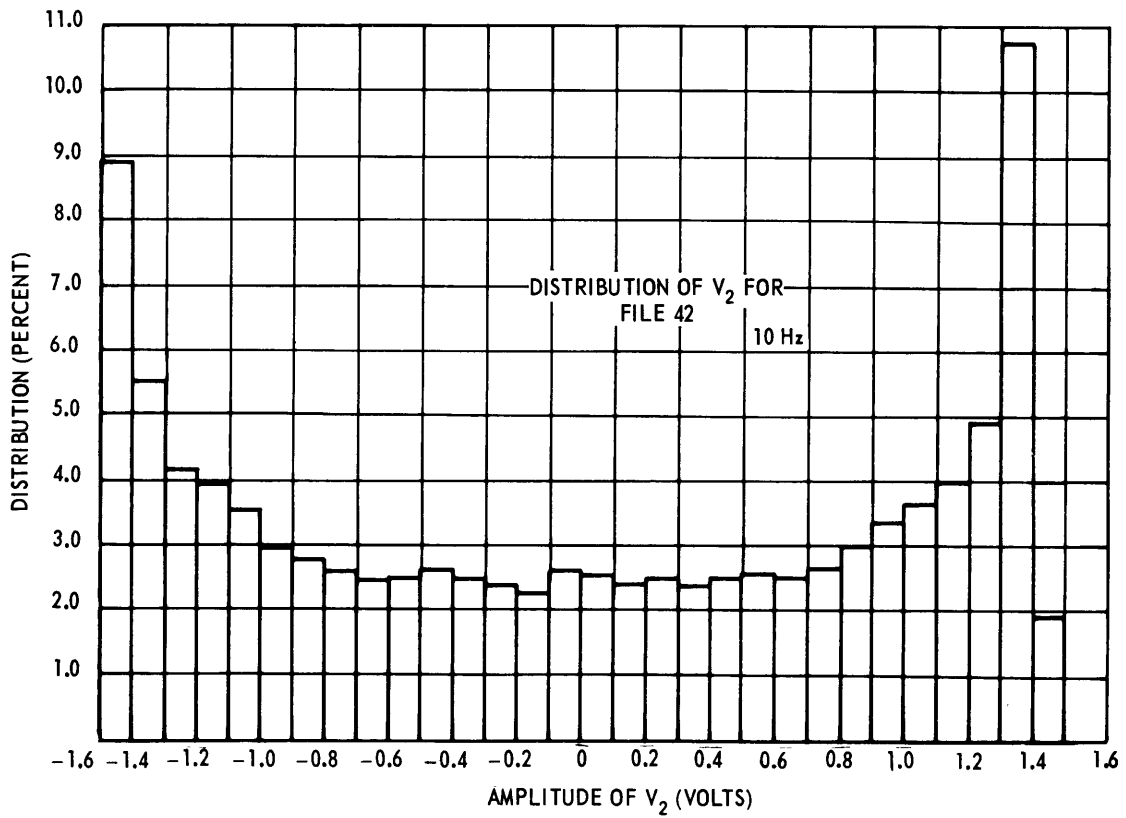
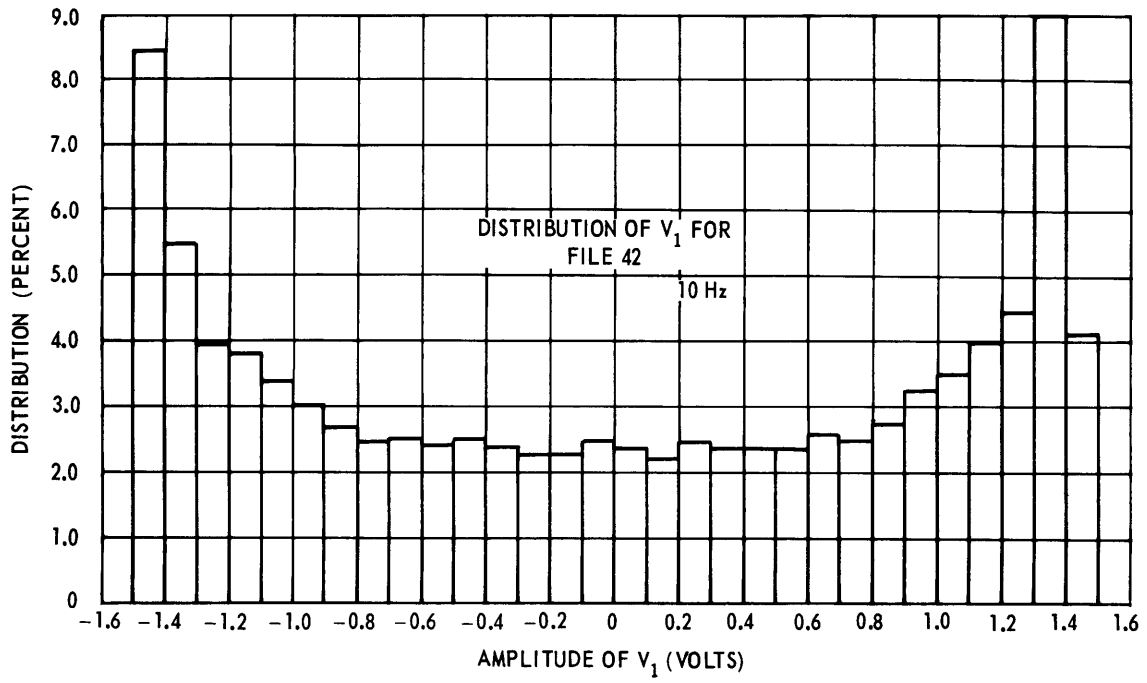

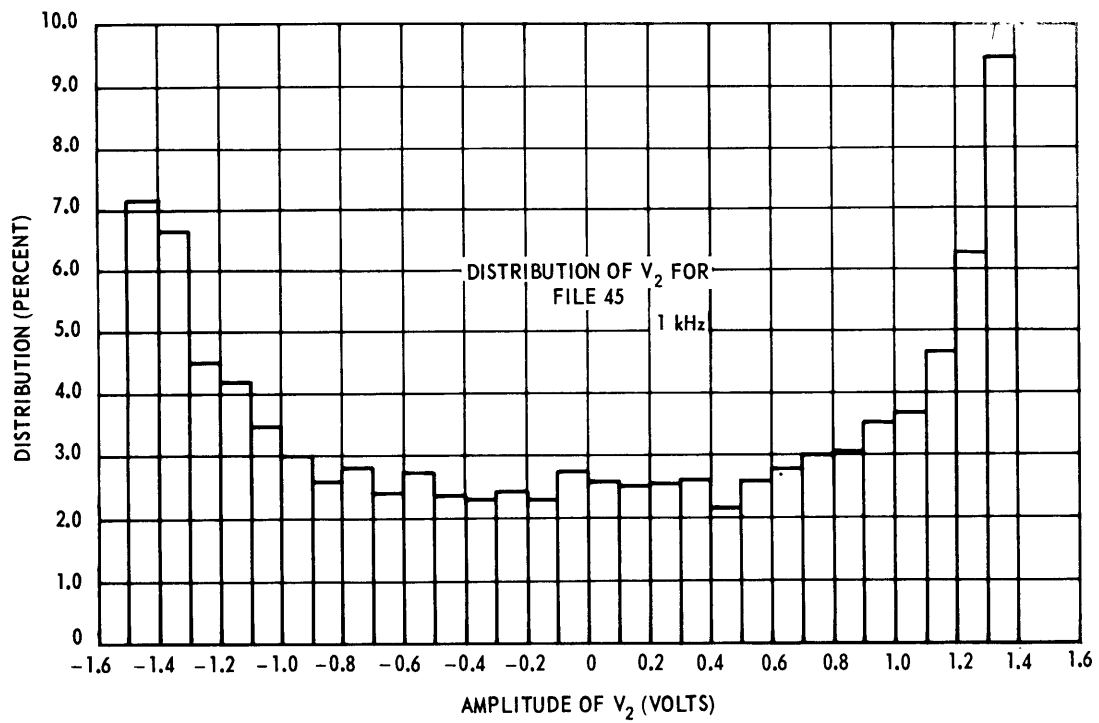
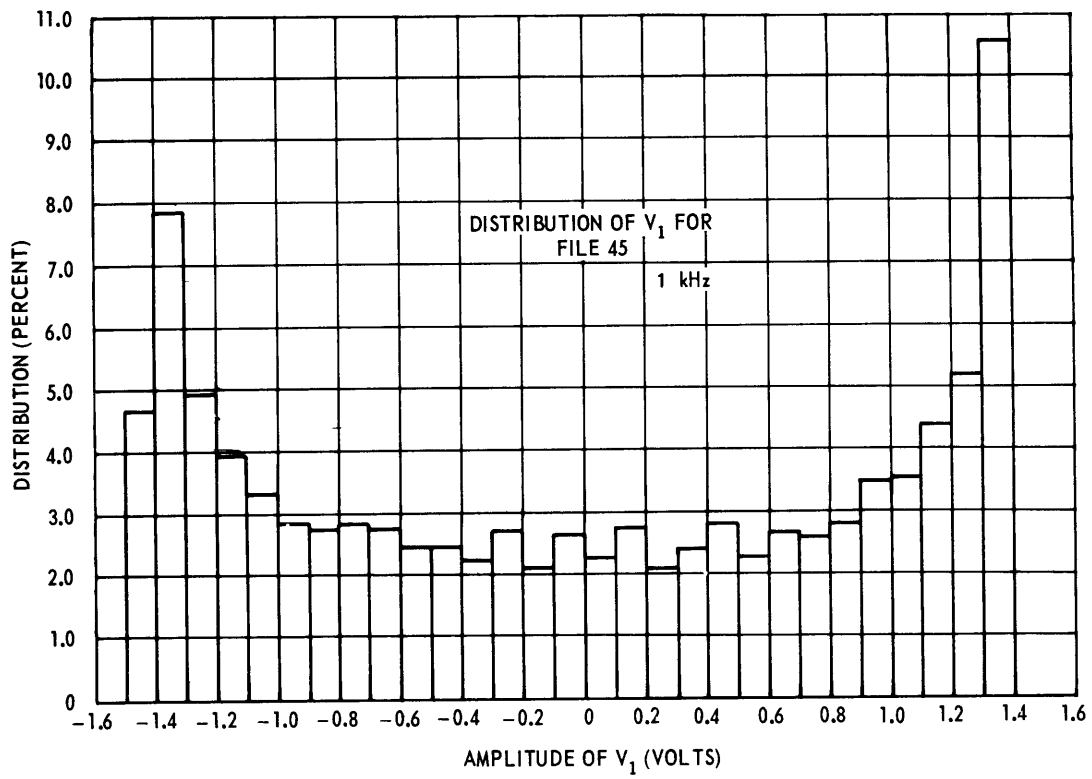

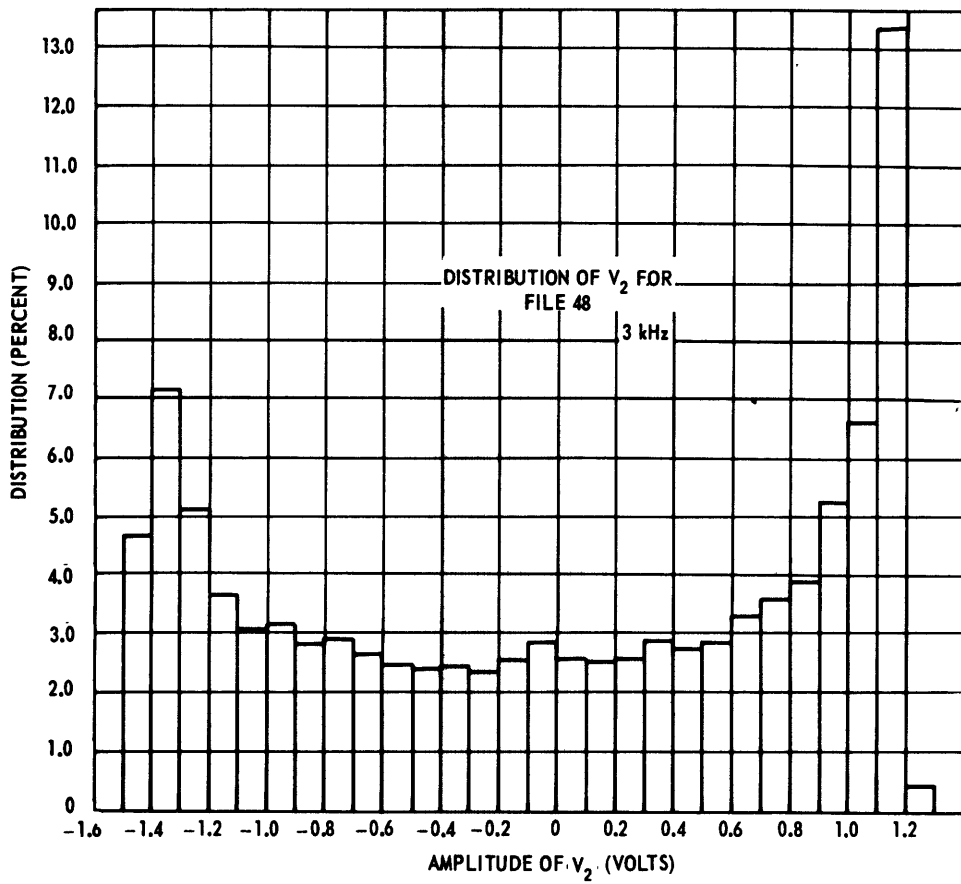
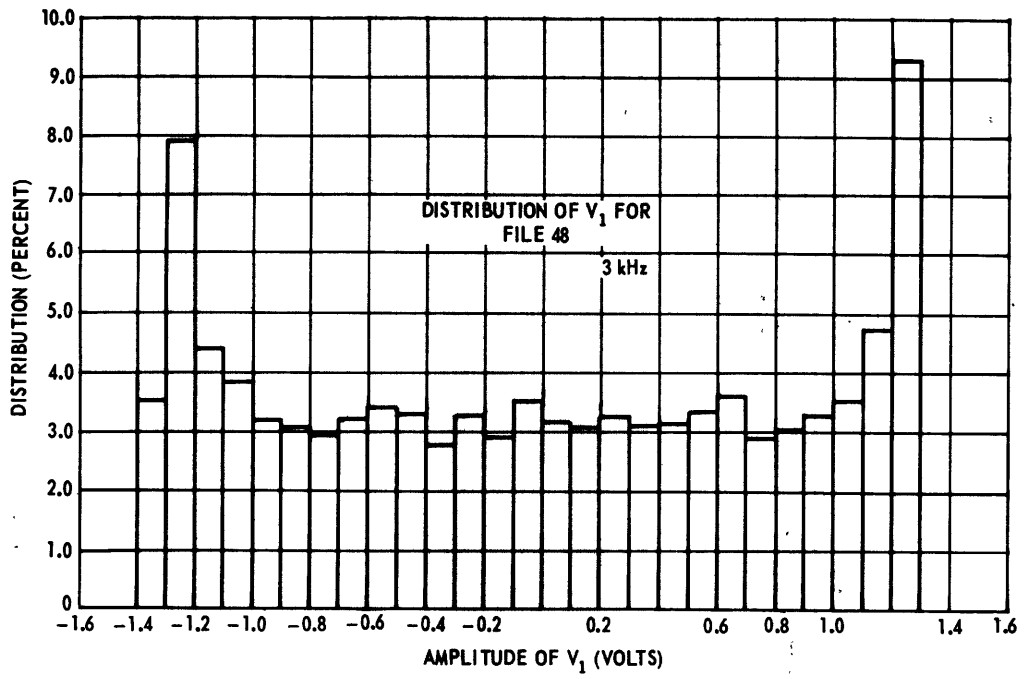

V1 FILE 18 TAPE DTT-2  
 PERCENTAGES OF TIME WITHIN VOLTAGE INTERVALS

INTERVAL MIOPOINTS	.09	.08	.07	.06	.05	.04	.03	.02	.01	.00	TOTAL
-1.4 /	0.00000	0.00000	.10417	.00729	1.64062	1.40625	1.09375	.00729	.75521	.75521	7.36979
-1.3 /	.57292	.70312	.52083	.31250	.41667	.59896	.52083	.26042	.46875	.23437	4.60937
-1.2 /	.36458	.39063	.33854	.49479	.31250	.26042	.44271	.39063	.26042	.31250	3.56771
-1.1 /	.36458	.33854	.28646	.41667	.20833	.39063	.28646	.26042	.39063	.31250	3.25521
-1.0 /	.33854	.28646	.33854	.31250	.28646	.20833	.41667	.18229	.23437	.41667	3.02083
-.9 /	.26042	.26042	.23437	.36458	.20833	.20833	.26042	.23437	.26042	.18229	2.47396
-.8 /	.26042	.28646	.18229	.26042	.15625	.28646	.13021	.20833	.23437	.36458	2.36979
-.7 /	.15625	.18229	.20833	.31250	.26042	.13021	.23437	.28646	.15625	.41667	2.34375
-.6 /	.18229	.26042	.20833	.23437	.36458	.20833	.10417	.33854	.23437	.23437	2.36979
-.5 /	.26042	.36458	.20833	.26042	.15625	.31250	.26042	.20833	.26042	.18229	2.47396
-.4 /	.28646	.26042	.13021	.28646	.28646	.28646	.10417	.28646	.26042	.26042	2.44792
-.3 /	.18229	.26042	.20833	.28646	.23437	.28646	.13021	.18229	.28646	.23437	2.29167
-.2 /	.28646	.20833	.26042	.26042	.15625	.26042	.26042	.13021	.23437	.39063	2.44792
-.1 /	.07812	.26042	.20833	.26042	.15625	.23437	.28646	.13021	.31250	.20833	2.13542
-0.0 /	.26042	.20833	.28646	.20833	.18229	.23437	.18229	.26042	.15625	.41667	2.39583
0.0 /		.31250	.15625	.28646	.31250	.13021	.26042	.20833	.20833	.26042	2.13542
.1 /	.15625	.28646	.23437	.13021	.28646	.23437	.36458	.15625	.15625	.23437	2.23958
.2 /	.20833	.26042	.23437	.26042	.23437	.20833	.20833	.36458	.23437	.07812	2.29167
.3 /	.31250	.23437	.15625	.26042	.20833	.36458	.10417	.26042	.26042	.31250	2.47396
.4 /	.23437	.20833	.18229	.31250	.18229	.28646	.20833	.28646	.20833	.28646	2.39583
.5 /	.20833	.10417	.33854	.26042	.36458	.10417	.31250	.26042	.23437	.23437	2.42187
.6 /	.28646	.23437	.33854	.31250	.23437	.18229	.39063	.18229	.33854	.28646	2.78646
.7 /	.31250	.28646	.33854	.26042	.26042	.26042	.39063	.18229	.44271	.26042	2.99479
.8 /	.26042	.26042	.31250	.46875	.20833	.39063	.33854	.33854	.18229	.33854	3.09856
.9 /	.54687	.28646	.26042	.28646	.49479	.23437	.44271	.52083	.31250	.33854	3.72396
1.0 /	.36458	.49479	.36458	.28646	.49479	.49479	.26042	.52083	.39063	.41667	4.08854
1.1 /	.39063	.44271	.41667	.54687	.49479	.41667	.44271	.33854	.49479	.41667	4.40104
1.2 /	.49479	.49479	.54687	.36458	.59896	.54687	.52083	.46875	.59896	.54687	5.18229
1.3 /	.62500	.84729	.72917	.78125	.83333	1.04167	1.22396	1.25000	1.51042	1.69271	10.49479
1.4 /	2.31771	1.30208	.07812	0.00000	0.00000	0.00000	0.00000	0.00000	0.00000	0.00000	3.69792

TOTAL DATA POINTS = 3840

V2 FILE 18 TAPE DTT-2  
 PERCENTAGES OF TIME WITHIN VOLTAGE INTERVALS

INTERVAL  
 MIDPOINTS

	.09	.08	.07	.06	.05	.04	.03	.02	.01	.00	TOTAL
-1.4 /	0.00000	0.00000	.26313	.67206	1.68335	1.26058	1.20036	.98456	.61863	.93113	7.61380
-1.3 /	.56179	.61727	.58648	.34668	.37543	.64060	.53440	.29324	.42887	.24048	4.62524
-1.2 /	.47824	.37476	.47757	.35143	.37272	.29324	.35007	.42684	.29324	.24291	3.66062
-1.1 /	.34804	.37340	.52829	.21918	.23980	.37476	.31996	.42345	.21851	.37272	3.41810
-1.0 /	.32132	.31996	.32132	.32064	.34600	.29188	.24523	.16100	.39673	.27127	2.99933
-.9 /	.42345	.26720	.18840	.26991	.23980	.29188	.29324	.21444	.21512	.23912	2.64255
-.8 /	.29324	.24183	.19704	.16313	.34261	.18975	.21172	.16168	.31860	.26991	2.37942
-.7 /	.23844	.17891	.29188	.24251	.24116	.28985	.18840	.18975	.31657	.29731	2.40479
-.6 /	.26516	.21512	.23980	.29256	.21783	.26584	.18500	.34736	.21444	.24048	2.48359
-.5 /	.21512	.42616	.21376	.21512	.29053	.24251	.24116	.16168	.29324	.34329	2.64255
-.4 /	.18975	.24116	.13360	.29392	.26788	.29392	.23709	.21579	.21512	.31928	2.40750
-.3 /	.26516	.21512	.18772	.24183	.29256	.13767	.28985	.23912	.21579	.26692	2.35135
-.2 /	.31996	.16168	.26720	.26720	.21240	.18917	.18907	.28985	.26652	.27859	2.43354
-.1 /	.18433	.13699	.23980	.26720	.29053	.29256	.21579	.18568	.13835	.31793	2.26915
0.0 /	.21512	.26584	.21579	.26584	.18704	.26652	.18704	.26720	.16032	.45356	2.48427
	.00	.01	.02	.03	.04	.05	.06	.07	.08	.09	TOTAL
0.0 /		.19043	.21240	.37204	.24251	.26381	.16303	.21376	.18772	.21512	2.06082
.1 /	.23844	.31996	.16235	.28985	.29392	.18840	.24387	.29053	.16032	.34455	2.53228
.2 /	.10959	.18917	.13631	.29324	.29256	.31793	.23980	.19179	.18840	.31453	2.27322
.3 /	.16439	.29256	.23844	.29324	.13563	.26991	.39334	.16303	.24116	.21647	2.48818
.4 /	.29256	.21376	.23912	.21647	.26516	.24183	.29188	.23980	.26788	.13767	2.48614
.5 /	.23980	.34125	.26923	.21512	.24387	.28917	.16439	.29324	.34465	.26852	2.66724
.6 /	.21579	.29256	.37340	.26855	.16235	.29121	.27059	.39537	.26923	.26788	2.80694
.7 /	.21647	.42413	.29527	.24116	.31928	.26720	.24455	.36933	.45424	.21512	3.04674
.8 /	.24116	.39741	.26155	.35075	.37001	.40080	.29527	.29527	.29121	.29527	3.20570
.9 /	.35279	.39888	.39741	.39808	.29934	.47485	.40215	.40419	.26855	.42548	3.82894
1.0 /	.47824	.29934	.42616	.37204	.48164	.45559	.44949	.30002	.58309	.36939	4.19501
1.1 /	.40080	.40215	.50564	.50933	.55976	.34939	.37611	.63382	.29934	.32335	4.35948
1.2 /	.58588	.66393	.56112	.29595	.51039	.71737	.53440	.53304	.69268	.58716	5.68183
1.3 /	.64128	.64602	.64399	.95785	.72483	1.09484	1.25583	1.56901	1.57579	1.78887	10.89830
1.4 /	1.49265	.99745	.60099	.26042	.05208	.02604	0.00000	0.00000	0.00000	0.00000	3.42963

TOTAL DATA POINTS = 3840

V1 FILE 19 TAPE DTT-2  
 PERCENTAGES OF TIME WITHIN VOLTAGE INTERVALS

INTERVAL  
 MIDPOINTS

	.09	.08	.07	.06	.05	.04	.03	.02	.01	.00	TOTAL
-1.4 /	0.00000	0.00000	.02604	.08729	1.61458	1.87500	1.32812	1.25000	.78125	.83333	8.51562
-1.3 /	.72917	.78125	.44271	.80729	.52083	.46875	.57292	.49479	.46875	.59896	5.88542
-1.2 /	.31250	.39863	.33854	.52083	.36458	.39063	.39063	.52083	.33854	.46875	4.03646
-1.1 /	.31250	.54687	.36458	.39063	.46875	.36458	.31250	.33854	.39063	.33854	3.82812
-1.0 /	.44271	.36458	.36458	.26042	.44271	.33854	.31250	.33854	.33854	.39063	3.59375
-.9 /	.20833	.33854	.31250	.28646	.39063	.36458	.23437	.28646	.20833	.39063	3.02083
-.8 /	.18229	.26042	.33854	.18229	.31250	.23437	.18229	.31250	.39863	.26042	2.65625
-.7 /	.18229	.20833	.44271	.18229	.20833	.28646	.23437	.28646	.20833	.10417	2.36979
-.6 /	.31250	.23437	.31250	.23437	.26042	.13021	.36458	.23437	.18229	.31250	2.57812
-.5 /	.18229	.28646	.31250	.28646	.20833	.23437	.28646	.28646	.20833	.20833	2.44792
-.4 /	.28646	.36458	.20833	.20833	.20833	.31250	.20833	.23437	.20833	.31250	2.55208
-.3 /	.28646	.10417	.28646	.18229	.26042	.28646	.28646	.18229	.20833	.18229	2.26562
-.2 /	.13021	.31250	.20833	.26042	.18229	.28646	.23437	.18229	.26042	.15625	2.21354
-.1 /	.23437	.23437	.28646	.26042	.31250	.13021	.26042	.23437	.20833	.15625	2.31771
0.0 /	.23646	.18229	.28646	.13021	.33854	.15625	.20833	.28646	.31250	.44271	2.63021

	.08	.01	.02	.03	.04	.05	.06	.07	.08	.09	TOTAL
0.0 /		.23437	.20833	.18229	.18229	.39063	.13021	.15625	.26042	.20833	1.95312
.1 /	.31250	.28646	.15625	.13021	.13021	.33854	.23437	.15625	.23437	.26042	2.23958
.2 /	.23437	.13021	.33854	.28646	.20833	.18229	.28646	.23437	.33854	.20833	2.44792
.3 /	.18229	.18229	.20833	.28646	.20833	.31250	.23437	.20833	.15625	.28646	2.26562
.4 /	.28646	.31250	.15625	.28646	.18229	.39063	.23437	.15625	.23437	.15625	2.39583
.5 /	.18229	.26042	.28646	.23437	.28646	.23437	.15625	.39063	.20833	.20833	2.44792
.6 /	.15625	.36458	.31250	.31250	.23437	.13021	.23437	.28646	.23437	.26042	2.52604
.7 /	.13021	.41667	.15625	.15625	.28646	.33854	.26042	.15625	.52083	.23437	2.65625
.8 /	.20833	.33854	.15625	.23437	.28646	.31250	.33854	.23437	.36458	.26042	2.73437
.9 /	.26042	.31250	.31250	.31250	.41667	.33854	.15625	.33854	.23437	.41667	3.09896
1.0 /	.31250	.36458	.26042	.41667	.39063	.52083	.26042	.36458	.36458	.31250	3.56771
1.1 /	.39063	.33854	.28646	.57292	.36458	.39063	.44271	.26042	.44271	.28646	3.77604
1.2 /	.44271	.49479	.41667	.36458	.41667	.46875	.28646	.78125	.46875	.41667	4.55729
1.3 /	.59896	.70312	.49479	.59896	.85937	.65104	1.09375	1.38021	1.17188	1.53646	9.08854
1.4 /	1.71875	1.27604	.33854	0.00000	0.00000	0.00000	0.00000	0.00000	0.00000	0.00000	3.33333

TOTAL DATA POINTS = 3840



V2 FILE 19 TAPE OTT-2  
 PERCENTAGES OF TIME WITHIN VOLTAGE INTERVALS

INTERVAL  
 MIDPOINTS

	.09	.08	.07	.06	.05	.04	.03	.02	.01	.00	TOTAL
-1.4 /	0.00003	0.00000	.20901	.64602	1.76080	1.68945	1.59709	1.25651	.80160	.88295	8.76343
-1.3 /	.85232	.51514	.63653	.77623	.50836	.50700	.58784	.53372	.42887	.58851	5.93452
-1.2 /	.39876	.50496	.37340	.32606	.40012	.55705	.40080	.32606	.39944	.48886	4.16762
-1.1 /	.58293	.32674	.53033	.43080	.37679	.37408	.39876	.37340	.29663	.52965	4.11811
-1.0 /	.37611	.32199	.45220	.29324	.37611	.26923	.45085	.29527	.37340	.19246	3.40088
-.9 /	.29183	.34736	.42480	.24183	.47892	.32199	.26652	.34600	.31793	.21851	3.25575
-.8 /	.31725	.26720	.19111	.23912	.29460	.26652	.23912	.16439	.47892	.31928	2.77751
-.7 /	.16100	.34397	.16778	.18704	.39605	.24183	.31860	.16235	.26788	.21105	2.45755
-.6 /	.19043	.29256	.26955	.21444	.42345	.18568	.21783	.21444	.26516	.24251	2.51506
-.5 /	.34329	.21579	.32164	.39808	.10959	.21444	.29256	.18975	.16168	.37001	2.61583
-.4 /	.31996	.34804	.16168	.26584	.29188	.16439	.10959	.37069	.39605	.16439	2.59250
-.3 /	.18975	.18503	.16371	.29121	.18917	.21579	.18975	.39537	.23980	.34329	2.40275
-.2 /	.15964	.24251	.21376	.21512	.31725	.16371	.16235	.36933	.13699	.29053	2.27119
-.1 /	.16235	.13631	.42413	.18907	.29460	.18568	.26720	.13631	.23980	.29053	2.32590
-0.0 /	.16371	.21308	.29392	.31589	.19111	.29053	.23980	.31996	.16439	.32403	2.51641
.....											
	.00	.01	.02	.03	.04	.05	.06	.07	.08	.09	TOTAL
0.0 /		.44881	.16168	.34329	.26100	.16642	.21172	.21240	.21512	.13563	2.05607
.1 /	.26955	.18975	.16032	.31589	.28985	.11298	.18840	.26449	.18840	.26720	2.24582
.2 /	.26652	.44610	.19111	.11163	.23980	.26516	.37204	.29256	.24319	.18772	2.61583
.3 /	.26516	.23912	.23980	.24183	.23980	.21647	.31860	.23980	.10824	.34600	2.45483
.4 /	.21579	.21647	.13428	.24183	.31725	.42684	.18840	.21240	.29256	.16032	2.48614
.5 /	.18704	.21512	.26788	.29256	.24183	.29256	.34261	.14038	.18772	.29188	2.45958
.6 /	.29353	.40012	.21647	.32064	.21444	.23777	.16235	.29352	.16235	.21512	2.51378
.7 /	.28985	.16710	.31657	.21240	.26788	.32132	.24116	.34261	.30302	.34465	2.80355
.8 /	.21376	.29527	.21240	.34465	.18975	.34668	.37340	.29256	.34604	.29324	2.90975
.9 /	.18907	.32064	.37272	.29460	.37543	.26923	.23844	.29527	.31860	.37543	3.04945
1.0 /	.34668	.26991	.37137	.42752	.53101	.22190	.34532	.55637	.34804	.24251	3.66062
1.1 /	.42684	.39944	.31996	.40554	.42616	.55705	.42820	.37137	.27195	.42413	4.03063
1.2 /	.37611	.27330	.42752	.45220	.42752	.58512	.55433	.43701	.71533	.45356	4.78201
1.3 /	.56247	.64331	.68997	.74476	.80363	.52841	1.25244	.81719	1.59302	1.49835	9.53356
1.4 /	.95622	1.15302	.37340	.46875	.07812	0.00000	.02604	0.00000	0.00000	0.00000	3.05556

TOTAL DATA POINTS = 3840

V1 FILE 20 TAPE OTT-2  
 PERCENTAGES OF TIME WITHIN VOLTAGE INTERVALS

INTERVAL  
 MIDPOINTS

	.09	.08	.07	.06	.05	.04	.03	.02	.01	.00	TOTAL
-1.4 /	0.00000	0.00000	0.00000	0.00000	.10417	1.45833	1.43229	1.77083	1.48437	.98958	7.23958
-1.3 /	.88542	.49479	.83333	.62500	.65104	.46875	.70312	.33854	.65104	.49479	6.14583
-1.2 /	.46875	.46875	.33854	.62500	.36458	.39063	.44271	.39063	.28646	.54687	4.32292
-1.1 /	.39063	.44271	.33854	.39063	.44271	.46875	.41667	.57292	.20833	.36458	4.83846
-1.0 /	.28646	.41667	.36458	.31250	.26042	.49479	.33854	.28646	.39063	.39063	3.54167
-.9 /	.26042	.26042	.13021	.39063	.26042	.28646	.41667	.28646	.23437	.28646	2.73437
-.8 /	.39063	.31250	.23437	.20833	.33854	.28646	.36458	.36458	.13021	.15625	2.78646
-.7 /	.28646	.44271	.23437	.10417	.39063	.33854	.20833	.13021	.23437	.26042	2.63021
-.6 /	.33854	.13021	.20833	.28646	.23437	.20833	.26042	.31250	.23437	.33854	2.55208
-.5 /	.18229	.28646	.23437	.33854	.23437	.20833	.18229	.31250	.33854	.20833	2.63021
-.4 /	.07812	.18229	.31250	.41667	.18229	.23437	.13021	.36458	.18229	.13021	2.21354
-.3 /	.20833	.36458	.23437	.13021	.13021	.39063	.36458	.23437	.18229	.20833	2.44792
-.2 /	.20833	.46875	.23437	.20833	.26042	.18229	.13021	.18229	.31250	.39063	2.57812
-.1 /	.15625	.18229	.10417	.28646	.33854	.15625	.15625	.23437	.13021	.20833	1.95312
-0.0 /	.26042	.15625	.28646	.33854	.18229	.26042	.15625	.18229	.23437	.44271	2.50000
	.00	.01	.02	.03	.04	.05	.06	.07	.08	.09	TOTAL
0.0 /		.23437	.28646	.13021	.18229	.28646	.31250	.23437	.18229	.28646	2.13542
.1 /	.36458	.15625	.20833	.18229	.28646	.15625	.26042	.23437	.26042	.23437	2.34375
.2 /	.31250	.05208	.23437	.33854	.23437	.20833	.15625	.20833	.41667	.20833	2.36979
.3 /	.23437	.13021	.28646	.23437	.23437	.28646	.15625	.20833	.28646	.28646	2.34375
.4 /	.15625	.23437	.20833	.15625	.26042	.31250	.31250	.20833	.28646	.28646	2.13542
.5 /	.39063	.28646	.36458	.26042	.20833	.20833	.31250	.26042	.26042	.23437	2.78646
.6 /	.26042	.20833	.18229	.20833	.41667	.28646	.18229	.23437	.18229	.41667	2.57812
.7 /	.28646	.15625	.15625	.20833	.31250	.28646	.33854	.13021	.28646	.28646	2.44792
.8 /	.33854	.39063	.13021	.23437	.20833	.39063	.49479	.20833	.33854	.41667	3.15104
.9 /	.20833	.15625	.31250	.46875	.23437	.33854	.49479	.28646	.39063	.20833	3.6458
1.0 /	.33854	.26042	.49479	.28646	.26042	.33854	.41667	.26042	.41667	.36458	3.43750
1.1 /	.33854	.44271	.46875	.31250	.28646	.44271	.49479	.26042	.54687	.44271	4.03646
1.2 /	.26042	.31250	.54687	.44271	.54687	.41667	.54687	.57292	.52083	.54687	4.71354
1.3 /	.57292	.67708	.71312	.91146	.88542	.85937	.91146	1.27604	1.82292	1.82292	10.44271
1.4 /	1.40625	.20833	.02604	0.00000	0.00000	0.00000	0.00000	0.00000	0.00000	0.00000	1.64062

84

TOTAL DATA POINTS = 3840

V2 FILE 20 TAPE DTT-2  
 PERCENTAGES OF TIME WITHIN VOLTAGE INTERVALS

INTERVAL  
 MIDPOINTS

	.09	.08	.07	.06	.05	.04	.03	.02	.01	.00	TOTAL
-1.4 /	0.00000	0.00000	0.00000	.10417	.78396	1.41819	1.44355	1.92112	1.21053	.93723	7.81874
-1.3 /	.96056	.66393	.59462	.64128	.48570	.55908	.59123	.58173	.48570	.48144	6.04546
-1.2 /	.40283	.50700	.34736	.53711	.34814	.42684	.50632	.48080	.45017	.37882	4.50528
-1.1 /	.53101	.35007	.34736	.50496	.55840	.24658	.40148	.32742	.47418	.98912	4.14157
-1.0 /	.31996	.37543	.40012	.37272	.34532	.45559	.24319	.42413	.32267	.32267	3.58181
-.9 /	.26720	.42345	.42006	.45288	.16303	.29392	.24523	.31996	.31860	.21376	3.11008
-.8 /	.27059	.26855	.31860	.29184	.21715	.26788	.24387	.24387	.42006	.18636	2.72881
-.7 /	.37284	.32413	.16235	.10688	.27059	.39944	.29188	.02943	.31860	.31928	2.59454
-.6 /	.26923	.31589	.23981	.16371	.39673	.26584	.29324	.24251	.42277	.21715	2.82588
-.5 /	.23912	.26788	.26652	.21715	.21240	.16642	.18704	.29460	.29527	.18772	2.33412
-.4 /	.26245	.26516	.21647	.21918	.26516	.34465	.05547	.24387	.23912	.42006	2.53160
-.3 /	.34397	.16574	.21444	.15964	.36797	.27059	.26991	.29256	.26516	.16168	2.51166
-.2 /	.16168	.29867	.34465	.16168	.05887	.23912	.31589	.08287	.42480	.14038	2.22860
-.1 /	.18636	.23912	.23709	.21579	.21715	.36865	.26449	.24048	.15964	.13563	2.26440
-0.0 /	.11195	.34261	.37204	.13902	.21308	.08491	.23844	.31725	.18840	.58445	2.59115
0.0 /		.24048	.24183	.10756	.26516	.21579	.34668	.18840	.23912	.29392	2.13894
.1 /	.29595	.16132	.11959	.23912	.34600	.23844	.18907	.21444	.29324	.31860	2.48479
.2 /	.21647	.13156	.21444	.24319	.34465	.21376	.18636	.18772	.21918	.39605	2.35338
.3 /	.18840	.15964	.24183	.26652	.21444	.29392	.21240	.34397	.26788	.37204	2.56184
.4 /	.21240	.13631	.31793	.23844	.18917	.26855	.21647	.37001	.18772	.18433	2.32123
.5 /	.29663	.21579	.29595	.08491	.39635	.29188	.24251	.13699	.34532	.21444	2.52848
.6 /	.18907	.31793	.34329	.37001	.11502	.21579	.31725	.24048	.21308	.32335	2.64526
.7 /	.18975	.18636	.26449	.23980	.37272	.29392	.21715	.34193	.34600	.18975	2.64187
.8 /	.26923	.29663	.15964	.50090	.29188	.37476	.16914	.39605	.21715	.37543	3.05081
.9 /	.39635	.34261	.16439	.32471	.52694	.27330	.26788	.14038	.37001	.40012	3.20638
1.0 /	.45152	.37137	.48164	.26788	.29324	.45152	.37543	.26720	.40148	.45220	3.81348
1.1 /	.37341	.45424	.45492	.26855	.34600	.32403	.29934	.42345	.53507	.48215	3.88116
1.2 /	.44949	.45085	.58716	.42820	.48299	.43148	.76945	.43159	.66461	.45695	5.12275
1.3 /	.74409	.72076	.77352	.67478	.88243	1.06405	1.40394	1.28323	1.37560	1.47976	10.40215
1.4 /	1.02620	.65647	.18297	.05208	0.00000	0.00000	0.00000	0.00000	0.00000	0.00000	1.91772

88

TOTAL DATA POINTS = 3840

V1 FILE 21 TAPE OTT-2  
 PERCENTAGES OF TIME WITHIN VOLTAGE INTERVALS

INTERVAL  
 MIDPOINTS

	.09	.08	.07	.06	.05	.04	.03	.02	.01	.00	TOTAL
-1.4 /	0.00000	0.00100	0.00000	0.00000	0.00000	0.00000	.13021	1.40625	2.29167	1.09375	4.92107
-1.3 /	1.14583	.65104	.93750	.85937	.75521	.78125	.83333	.65104	.41667	.65104	7.68229
-1.2 /	.46875	.49479	.52083	.46875	.54687	.44271	.52083	.44271	.28646	.44271	4.63542
-1.1 /	.59896	.49479	.39063	.13021	.65104	.41667	.33854	.41667	.59896	.15625	4.19271
-1.0 /	.13021	.39063	.36458	.44271	.46875	.26042	.39063	.33854	.33854	.26042	3.38542
-.9 /	.41667	.26042	.33854	.33854	.28646	.31250	.31250	.36458	.31250	.41667	3.35937
-.8 /	.39063	.18229	.49479	.13021	.41667	.31250	.78125	.31250	.26042	.13021	2.78833
-.7 /	.33854	.26042	.28646	.28646	.15625	.39063	.26042	.15625	.15625	.36458	2.65625
-.6 /	.20433	.18229	.23437	.36458	.23437	.28646	.28646	.18229	.33854	.20833	2.52684
-.5 /	.15625	.31250	.36458	.20833	.28646	.15625	.28646	.15625	.15625	.23437	2.31771
-.4 /	.31250	.23437	.28646	.15625	.28646	.23437	.13021	.23437	.39063	.31250	2.57812
-.3 /	.15625	.26042	.20833	.18229	.36458	.33854	.15625	.23437	.13021	.36458	2.39583
-.2 /	.20833	.26042	.15625	.23437	.20833	.28646	.23437	.33854	.20833	.36458	2.50000
-.1 /	.18229	.33854	.28646	.13021	.23437	.26042	.33854	.18229	.28646	.26042	2.50000
-0.0 /	.28646	.10417	.26042	.31250	.20833	.26042	.13021	.20833	.31250	.57292	2.65625
0.0 /											
.1 /	.18229	.18229	.26042	.26042	.20833	.13021	.18229	.20833	.15625	.13021	1.90104
.2 /	.23437	.28646	.15625	.23437	.23437	.28646	.33854	.18229	.23437	.28646	2.47396
.3 /	.26042	.20833	.23437	.13021	.18229	.20833	.28646	.18417	.31250	.23437	2.16146
.4 /	.28646	.10417	.20833	.31250	.28646	.26042	.28646	.23437	.20833	.26042	2.44792
.5 /	.39063	.28646	.31250	.28646	.31250	.28646	.28646	.23437	.23437	.15625	2.78646
.6 /	.41667	.15625	.26042	.20833	.20833	.26042	.28646	.31250	.18229	.31250	2.60417
.7 /	.13021	.39063	.20833	.28646	.41667	.28646	.18229	.39063	.28646	.20833	2.78646
.8 /	.26042	.18229	.33854	.33854	.28646	.20833	.28646	.18229	.28646	.23437	2.60417
.9 /	.26042	.44271	.20433	.41667	.46875	.20833	.26042	.33854	.33854	.23437	3.17708
1.0 /	.26042	.36458	.49479	.33854	.49479	.23437	.31250	.39063	.49479	.31250	3.69792
1.1 /	.49479	.31250	.39063	.31250	.49479	.33854	.52083	.36458	.52083	.44271	4.19271
1.2 /	.41667	.49479	.44271	.65104	.57292	.57292	.52083	.44271	.72917	.70312	5.54687
1.3 /	.65104	1.04167	.70312	.75521	.91146	1.38021	1.22396	2.03125	1.45833	.36458	10.52083
1.4 /	.02604	0.00000	0.00000	0.00000	0.00000	0.00000	0.00000	0.00000	0.00000	0.00000	.02604

TOTAL DATA POINTS = 3840

88

V2 FILE 21 TAPE DTT-2  
PERCENTAGES OF TIME WITHIN VOLTAGE INTERVALS

INTERVAL MIDPOINTS	.09	.08	.07	.06	.05	.04	.03	.02	.01	.00	TOTAL
-1.4 /	0.00000	0.00000	0.00000	0.00000	.10417	.46875	2.86060	1.78141	1.25760	1.27040	6.95109
-1.3 /	1.01942	.64195	.75350	.77759	.90508	.38493	.72403	.45966	.71398	.40578	6.86673
-1.2 /	.29867	.48164	.66461	.40283	.40487	.61049	.40419	.58445	.34600	.27195	4.46967
-1.1 /	.32810	.35143	.45288	.28985	.38154	.60981	.55569	.16710	.35414	.57699	4.06752
-1.0 /	.31589	.29663	.42616	.37611	.37679	.24116	.32267	.42540	.39944	.34532	3.52566
-.9 /	.42752	.24116	.32132	.34736	.37204	.32064	.21547	.34804	.24251	.34939	3.18644
-.8 /	.27059	.23912	.27330	.26381	.16710	.37272	.36662	.34668	.29324	.18756	2.78874
-.7 /	.24319	.37137	.39808	.21579	.21240	.19246	.26720	.26449	.29053	.32199	2.77751
-.6 /	.37001	.21308	.18840	.26991	.31860	.26788	.16371	.26516	.24319	.23980	2.53374
-.5 /	.13429	.34668	.19179	.23980	.31996	.34261	.18975	.18636	.23844	.26652	2.45619
-.4 /	.24251	.18840	.39808	.16032	.24193	.21444	.31509	.26652	.24455	.26055	2.54110
-.3 /	.18636	.26720	.16168	.31725	.26991	.32132	.18636	.24048	.18568	.19179	2.32802
-.2 /	.37001	.26720	.21240	.18840	.31793	.37204	.21444	.19111	.23980	.19179	2.56510
-.1 /	.26516	.21715	.29392	.21172	.18840	.19907	.21715	.26516	.18975	.26720	2.30469
-0.0 /	.39808	.15896	.21512	.16439	.23980	.21512	.42006	.26504	.08026	.43159	2.59521
	.00	.01	.02	.03	.04	.05	.06	.07	.08	.09	TOTAL
0.0 /		.26381	.34660	.26652	.21240	.26855	.11230	.34193	.21512	.24048	2.26712
.1 /	.23912	.23912	.26720	.21512	.18772	.26381	.39537	.21376	.31657	.13360	2.47138
.2 /	.16235	.13767	.42074	.24048	.11027	.16371	.37340	.08227	.29256	.21579	2.19984
.3 /	.16303	.23990	.11860	.26381	.21308	.18772	.21579	.18500	.34668	.21444	2.34795
.4 /	.18975	.31521	.16168	.21647	.26788	.24116	.34600	.16235	.21376	.29324	2.40750
.5 /	.27059	.24183	.21647	.31996	.08626	.21579	.18975	.37069	.39673	.13428	2.44236
.6 /	.37543	.08219	.21512	.31793	.26584	.21512	.18975	.32064	.26516	.37272	2.61990
.7 /	.26381	.42684	.21376	.29392	.24523	.34600	.23912	.37476	.24103	.34397	2.98923
.8 /	.31928	.26516	.19111	.24319	.26788	.29188	.39808	.34329	.39808	.31860	3.03657
.9 /	.24116	.35007	.34397	.21918	.40283	.29188	.31928	.26923	.32132	.37069	3.12961
1.0 /	.34532	.34804	.42955	.26923	.40351	.31860	.19043	.32267	.45559	.39876	3.48172
1.1 /	.37747	.37272	.53151	.42480	.45559	.45152	.45627	.45220	.48231	.48828	4.48419
1.2 /	.53164	.63789	.42820	.53779	.53575	.50971	.89898	.68861	.61795	.74748	6.13403
1.3 /	.64195	.65213	1.00789	1.45196	1.32582	1.41615	1.29375	1.61540	.74110	.45220	10.58836
1.4 /	.13089	.07612	0.00000	0.00000	0.00000	0.00000	0.00000	0.00000	0.00000	0.00000	.20901

TOTAL DATA POINTS = 3840

V1 FILE 22 TAPE DTT-2  
 PERCENTAGES OF TIME WITHIN VOLTAGE INTERVALS

INTERVAL MIDPOINTS	.09	.08	.07	.06	.05	.04	.03	.02	.01	.00	TOTAL
-1.4 /	0.00000	0.00000	0.00000	0.00000	0.00000	0.00000	0.00000	0.00000	0.00000	.10417	.10417
-1.3 /	.62500	1.71875	1.95313	1.35417	.93750	.72917	.80729	.65104	.52083	.59896	9.89583
-1.2 /	.57292	.57292	.39063	.44271	.49479	.39063	.44271	.36458	.41667	.46875	4.55729
-1.1 /	.39063	.46875	.46875	.59896	.36458	.36458	.46875	.46875	.36458	.36458	4.32292
-1.0 /	.31250	.57292	.33854	.46875	.52083	.28646	.31250	.57292	.28833	.28646	3.88821
-.9 /	.36458	.18229	.39063	.36458	.23437	.28646	.41667	.33854	.28646	.41667	3.28125
-.8 /	.26042	.26042	.33854	.26042	.44271	.33854	.26042	.33854	.23437	.31250	3.04687
-.7 /	.36458	.31250	.15625	.39063	.28646	.20833	.28646	.39063	.33854	.33854	3.07292
-.6 /	.36458	.33854	.17417	.23437	.33854	.39063	.23437	.26042	.18229	.23437	2.68229
-.5 /	.33854	.15625	.31250	.15625	.33854	.31250	.13021	.36458	.26042	.28833	2.57812
-.4 /	.39063	.23437	.26042	.28646	.26042	.28646	.18229	.15625	.23437	.31250	2.68417
-.3 /	.49479	.18229	.26042	.28646	.20833	.18229	.28646	.26042	.26042	.31250	2.73437
-.2 /	.26042	.15625	.23437	.26042	.26042	.39063	.31250	.23437	.18229	.26042	2.55208
-.1 /	.31250	.31250	.23437	.20833	.15625	.36458	.23437	.33854	.05208	.31250	2.52604
-0.0 /	.31250	.23437	.18229	.18229	.31250	.67812	.23437	.23437	.28646	.44271	2.50000
.....											
	.00	.01	.02	.03	.04	.05	.06	.07	.08	.09	TOTAL
0.0 /		.39063	.23437	.20833	.41667	.18229	.26042	.23437	.31250	.20833	2.44792
.1 /	.26042	.26042	.36458	.20833	.23437	.23437	.13021	.31250	.31250	.20833	2.52604
.2 /	.23437	.20833	.18229	.26042	.26042	.18229	.26042	.33854	.39063	.26042	2.57812
.3 /	.23437	.23437	.39063	.39063	.26042	.15625	.31250	.18229	.13821	.15625	2.44792
.4 /	.18229	.28646	.31250	.31250	.31250	.26042	.20833	.33854	.18229	.26042	2.65625
.5 /	.18229	.15625	.33854	.31250	.33854	.15625	.15625	.28646	.10417	.31250	2.36375
.6 /	.20833	.36458	.23437	.18229	.36458	.23437	.18229	.33854	.31250	.23437	2.65625
.7 /	.18229	.36458	.26042	.23437	.33854	.28646	.23437	.23437	.33854	.20833	2.68229
.8 /	.41667	.26042	.36458	.20833	.33854	.52083	.23437	.33854	.31250	.41667	3.41146
.9 /	.23437	.31250	.23437	.36458	.41667	.26042	.46875	.36458	.36458	.26042	3.28125
1.0 /	.65104	.18229	.44271	.36458	.28646	.49479	.49479	.23437	.57292	.41667	4.14862
1.1 /	.62500	.36458	.52083	.59896	.54687	.49479	.41667	.39063	.49479	.54687	5.88800
1.2 /	.52083	.54687	.31250	.57292	.52083	.52083	.65104	.78125	.80729	.80729	6.04167
1.3 /	.80729	.78125	1.22396	1.77083	2.08333	.67708	.10417	0.00000	0.00000	0.00000	7.44792
1.4 /	0.00000	0.00000	0.00000	0.00000	0.00000	0.00000	0.00000	0.00000	0.00000	0.00000	0.00000

TOTAL DATA POINTS = 3640

V2 FILE 22 TAPE DTT-2  
 PERCENTAGES OF TIME WITHIN VOLTAGE INTERVALS

INTERVAL  
 MIDPOINTS

	.09	.08	.07	.06	.05	.04	.03	.02	.01	.00	TOTAL
-1.4 /	0.00000	0.00000	0.00000	0.00000	.05208	.10417	1.17188	2.18750	1.61458	1.07842	6.28863
-1.3 /	.84961	.90413	1.04045	.45193	.54525	.77420	.69811	.38154	.32686	.71872	6.69000
-1.2 /	.43159	.56179	.60913	.42820	.40351	.42684	.48028	.29595	.42752	.58812	4.64993
-1.1 /	.37476	.58512	.42887	.27601	.42616	.29595	.35075	.27262	.40012	.48812	3.81849
-1.0 /	.32064	.41554	.37340	.27262	.48231	.29392	.39876	.30138	.37001	.31986	3.53855
-.9 /	.34874	.36933	.29663	.37408	.18840	.39888	.21918	.37340	.21579	.29731	3.08824
-.8 /	.31923	.31928	.29527	.31928	.21986	.24319	.31928	.26923	.31863	.29468	2.91789
-.7 /	.29595	.24251	.23844	.32267	.31996	.26584	.08558	.27359	.34736	.19111	2.50082
-.6 /	.24387	.32132	.31521	.29256	.24319	.32267	.18840	.29324	.26516	.18840	2.67402
-.5 /	.26923	.16032	.19043	.23844	.39944	.19043	.31589	.21783	.18907	.29188	2.46297
-.4 /	.32267	.26652	.21512	.16371	.29324	.21579	.31725	.18636	.24348	.13835	2.35948
-.3 /	.24726	.29121	.16303	.26788	.31793	.23912	.16371	.34532	.16303	.26855	2.46704
-.2 /	.24116	.23844	.16235	.31928	.34532	.37476	.24251	.18840	.21308	.26720	2.59253
-.1 /	.16439	.24251	.18840	.29188	.16032	.26991	.34465	.19111	.26177	.21647	2.33141
-0.0 /	.19043	.31864	.18704	.26516	.24251	.18433	.18840	.24048	.24183	.66257	2.72135
0.0 /		.14038	.37069	.21376	.21918	.18704	.24116	.13631	.21647	.16168	1.88666
.1 /	.26720	.31928	.32199	.23980	.24048	.26652	.18568	.29460	.19043	.18772	2.51373
.2 /	.18840	.23980	.18704	.31928	.18917	.18704	.29324	.16507	.27059	.26720	2.30672
.3 /	.24348	.13631	.27059	.16642	.24116	.18636	.29460	.29121	.23777	.31657	2.38146
.4 /	.13496	.21579	.24251	.21647	.21647	.24116	.03147	.39944	.26516	.29324	2.25667
.5 /	.31725	.29053	.32132	.24251	.29527	.29053	.31657	.13767	.34125	.32064	2.87354
.6 /	.26584	.29595	.26652	.18704	.24387	.47485	.31725	.34736	.24251	.26652	2.90771
.7 /	.29121	.24347	.39741	.29256	.37340	.34600	.34465	.26652	.29527	.44813	3.29982
.8 /	.29731	.31928	.29595	.23980	.42548	.37815	.34465	.29527	.34668	.42752	3.37809
.9 /	.21444	.42480	.31863	.37408	.32335	.34532	.50700	.29595	.29595	.37137	3.47087
1.0 /	.22529	.57766	.24590	.37408	.45017	.53372	.37747	.34465	.43159	.45356	4.01408
1.1 /	.43294	.45220	.58648	.38018	.53507	.53372	.45356	.63517	.71601	.63924	5.36458
1.2 /	.79481	.53507	.84147	.71804	1.02919	.74273	1.24091	1.00993	1.21894	1.66165	9.79275
1.3 /	1.58352	1.66197	1.39958	.43674	.13238	.14784	.02875	0.00000	0.00000	0.00000	5.08979
1.4 /	0.00000	0.00000	0.00000	0.00000	0.00000	0.00000	0.00000	0.00000	0.00000	0.00000	0.00000

TOTAL DATA POINTS = 3840

V1 FILE 23 TAPE OTT-2  
 PERCENTAGES OF TIME WITHIN VOLTAGE INTERVALS

INTERVAL  
 MIDPOINTS

	.09	.08	.07	.06	.05	.04	.03	.02	.01	.00	TOTAL
-1.4 /	0.00000	0.00000	0.00000	0.00000	0.00000	0.00000	0.00000	0.00000	0.00000	0.00000	0.00000
-1.3 /	0.00000	0.00000	.32604	.10417	.96354	1.84896	1.51042	1.06771	1.11979	.75521	7.39503
-1.2 /	.65104	.78125	.54687	.67708	.70312	.36458	.54687	.70312	.54687	.39063	5.91146
-1.1 /	.20833	.49479	.49479	.39063	.39063	.49479	.31250	.41667	.36458	.44271	4.01042
-1.0 /	.23437	.36458	.39063	.33854	.41667	.44271	.18229	.28646	.41667	.31250	3.30842
-.9 /	.23437	.20833	.44271	.33854	.44271	.39063	.57292	.26042	.31250	.46875	3.67187
-.8 /	.36458	.36458	.28646	.44271	.33854	.44271	.44271	.41667	.36458	.41667	3.80021
-.7 /	.26042	.20833	.36458	.39063	.26042	.33854	.18229	.20833	.20833	.33437	2.69625
-.6 /	.36458	.31250	.20833	.44271	.33854	.31250	.15625	.23437	.33854	.20833	2.91667
-.5 /	.26042	.33854	.23437	.39063	.20833	.15625	.28646	.28646	.33854	.33854	2.83854
-.4 /	.31250	.15625	.23437	.33854	.44271	.15625	.31250	.23437	.23437	.36458	2.78646
-.3 /	.10417	.18229	.36458	.41667	.23437	.39063	.26042	.31250	.20833	.39063	2.86458
-.2 /	.26042	.20833	.28646	.44271	.26042	.23437	.15625	.28646	.26042	.33854	2.73437
-.1 /	.33854	.31250	.28646	.31250	.23437	.23437	.31250	.28646	.18229	.33854	2.83854
-0.0 /	.20833	.18229	.31250	.15625	.46875	.18229	.26042	.39063	.28646	.54687	2.99479
.....											
	.00	.01	.02	.03	.04	.05	.06	.07	.08	.09	TOTAL
0.0 /		.18229	.26042	.39063	.10417	.28646	.28646	.26042	.23437	.33854	2.34375
.1 /	.20833	.18229	.20833	.39063	.20833	.20833	.39063	.28646	.28646	.28646	2.65625
.2 /	.28646	.23437	.28646	.28646	.33854	.20833	.15625	.36458	.33854	.31250	2.81250
.3 /	.20833	.23437	.20833	.26042	.23437	.36458	.18229	.49479	.20833	.26042	2.65625
.4 /	.33854	.33854	.44271	.13021	.28646	.23437	.26042	.26042	.36458	.28646	2.94271
.5 /	.23437	.33854	.18229	.26042	.28646	.41667	.31250	.23437	.31250	.36458	2.94271
.6 /	.23437	.13021	.41667	.26042	.26042	.23437	.39063	.31250	.31250	.31250	2.86458
.7 /	.31250	.28646	.31250	.23437	.28646	.54687	.31250	.41667	.15625	.15625	3.02083
.8 /	.39063	.23437	.39063	.54687	.44271	.39063	.26042	.41667	.46875	.28646	3.82012
.9 /	.44271	.18229	.57292	.41667	.46875	.26042	.28646	.28646	.36458	.26042	3.54167
1.0 /	.44271	.31250	.18229	.49479	.31250	.33854	.41667	.46875	.46875	.20833	3.64583
1.1 /	.44271	.54687	.44271	.31250	.57292	.70312	.36458	.44271	.49479	.54687	4.86979
1.2 /	.39063	.44271	.85937	.52083	.57292	.57292	.98958	1.01562	.83333	1.51042	7.70033
1.3 /	1.77183	1.22396	.20833	.07812	0.00000	0.00000	0.00000	0.00000	0.00000	0.00000	3.28125
1.4 /	0.00000	0.00000	0.00000	0.00000	0.00000	0.00000	0.00000	0.00000	0.00000	0.00000	0.00000

TOTAL DATA PCINTS = 3840



V2 FILE 23 TAPE OTT-2  
 PERCENTAGES OF TIME WITHIN VOLTAGE INTERVALS

INTERVAL  
 MIDPOINTS

	.09	.08	.07	.06	.05	.04	.03	.02	.01	.00	TOTAL
-1.4 /	.02607	.02607	0.00000	0.00000	.02607	0.00000	.36496	1.45905	1.90302	1.66040	5.47445
-1.3 /	1.01668	.75600	.73061	.75871	.78291	.75206	.48254	.52314	.65484	.56713	6.94463
-1.2 /	.59049	.38533	.56170	.64330	.48757	.45267	.37922	.67005	.37922	.50949	5.05504
-1.1 /	.42253	.32572	.24752	.42728	.37515	.37786	.42525	.37583	.27019	.45071	3.70204
-1.0 /	.29287	.19199	.42728	.34772	.34976	.29830	.31758	.34636	.21941	.42625	3.21651
- .9 /	.24073	.13791	.45471	.37379	.22009	.24480	.48417	.29355	.32097	.29898	3.11970
- .8 /	.37447	.21805	.24209	.32437	.21738	.29830	.29830	.21941	.19199	.32369	2.78003
- .7 /	.34568	.42253	.29626	.24480	.21534	.21738	.34365	.16184	.18791	.34500	2.78040
- .6 /	.27019	.37311	.24005	.37650	.32165	.26883	.18656	.31894	.19131	.24005	2.78719
- .5 /	.34568	.24344	.21466	.21873	.34433	.26476	.24209	.21602	.16524	.26951	2.52447
- .4 /	.19063	.26476	.24073	.32165	.29830	.05621	.21670	.24073	.29287	.32233	2.44490
- .3 /	.18520	.23937	.11378	.24548	.29287	.14053	.21534	.19083	.16184	.16660	1.95163
- .2 /	.21534	.34433	.32029	.24616	.29355	.24073	.23869	.24209	.37175	.16524	2.67816
- .1 /	.16524	.37311	.18995	.13849	.24073	.31894	.24277	.21602	.31758	.34772	2.55854
-0.0 /	.29219	.21330	.26883	.13442	.19470	.26544	.21534	.24480	.26816	.53963	2.63282
	.00	.01	.02	.03	.04	.05	.06	.07	.08	.09	TOTAL
0.0 /		.26544	.29355	.16660	.31554	.26816	.26816	.18927	.34500	.21738	2.32909
.1 /	.10971	.23937	.31826	.21873	.24005	.18791	.24480	.08567	.26816	.37243	2.28810
.2 /	.24209	.11039	.24209	.32029	.29558	.18791	.16049	.24412	.26951	.16456	2.23703
.3 /	.34433	.21466	.13578	.29355	.37107	.29626	.18723	.11717	.29219	.18927	2.44151
.4 /	.37379	.26951	.32437	.18588	.32029	.37107	.24141	.21534	.29826	.26816	2.86688
.5 /	.16252	.39986	.34365	.29355	.21602	.32369	.24277	.37107	.29490	.21805	2.86688
.6 /	.39714	.29015	.24548	.37175	.34568	.34500	.34908	.21670	.42525	.32097	3.38721
.7 /	.26883	.42457	.34704	.34560	.24209	.45743	.37311	.27155	.42117	.47331	3.62411
.8 /	.21873	.29287	.34908	.32708	.32437	.53156	.21534	.34976	.37718	.42457	3.41854
.9 /	.27223	.36972	.37990	.45403	.35111	.60637	.18995	.34636	.37447	.52817	3.87231
1.0 /	.68933	.45132	.50006	.53428	.47739	.42593	.63651	.37718	.50753	.52681	5.12633
1.1 /	.68933	.63991	.74147	.45132	.51024	.80039	.81764	1.02822	1.02958	.97880	7.68691
1.2 /	1.23542	1.28891	1.76901	1.78626	1.57906	1.03162	.52110	.46965	.89993	.03937	9.82834
1.3 /	.04616	.05798	.00543	.02811	0.00000	0.00000	0.00000	0.00000	0.00000	0.00000	.13760
1.4 /	0.00000	0.00000	0.00000	0.00000	0.00000	0.00000	.02607	0.00000	0.00000	0.00000	.02607

TOTAL DATA POINTS = 3836

V1 FILE 24 TAPE DTT-2  
 PERCENTAGES OF TIME WITHIN VOLTAGE INTERVALS

INTERVAL  
 MIDPOINTS

	.09	.08	.07	.06	.05	.04	.03	.02	.01	.00	TOTAL
-1.4 /	0.00000	0.00000	0.00000	0.00000	0.00000	0.00000	0.00000	0.00000	0.00000	0.00000	0.00000
-1.3 /	0.00000	0.00000	0.00000	0.00000	0.00000	0.00000	0.00000	0.00000	0.00000	0.00000	0.00000
-1.2 /	1.11979	1.09375	.62500	.78125	.70312	.88542	.52083	.57292	.52083	.67788	7.50860
-1.1 /	.44271	.39063	.52083	.39063	.44271	.39063	.52083	.36458	.36458	.33854	4.16667
-1.0 /	.44271	.26042	.26042	.44271	.33854	.33854	.23437	.33854	.28646	.28646	3.22917
-.9 /	.44271	.39063	.41667	.23437	.23437	.33854	.36458	.31250	.31250	.26042	3.38729
-.8 /	.41667	.28646	.28646	.18229	.20833	.41667	.18229	.20833	.26042	.41667	2.86458
-.7 /	.23437	.33854	.31250	.20833	.33854	.41667	.28646	.39063	.36458	.23437	3.12500
-.6 /	.54687	.41667	.28646	.33854	.26042	.31250	.33854	.41667	.23437	.54687	3.69792
-.5 /	.26042	.18229	.31250	.44271	.39063	.44271	.33854	.46875	.28646	.13821	3.82083
-.4 /	.18229	.26042	.28646	.31250	.36458	.36458	.36458	.26042	.26042	.28646	2.94271
-.3 /	.33854	.36458	.26042	.28646	.26042	.28646	.36458	.26042	.23437	.33854	2.99479
-.2 /	.23437	.28646	.26042	.39063	.31250	.13821	.46875	.18229	.31250	.20833	2.78646
-.1 /	.33854	.26042	.23437	.33854	.31250	.28646	.39063	.36458	.33854	.18229	3.84687
-0.0 /	.31250	.39063	.31250	.33854	.28646	.31250	.26042	.39063	.41667	.54687	3.56771
	.00	.01	.02	.03	.04	.05	.06	.07	.08	.09	TOTAL
0.0 /		.23437	.36458	.18229	.33854	.39063	.23437	.28646	.41667	.26042	2.78833
.1 /	.36458	.23437	.39063	.31250	.36458	.31250	.23437	.36458	.39063	.26042	3.22917
.2 /	.13821	.33854	.52083	.23437	.31250	.20833	.33854	.28646	.28646	.28646	2.94271
.3 /	.44271	.18229	.33854	.33854	.28646	.15625	.20833	.28646	.52083	.15625	2.91667
.4 /	.39063	.28646	.23437	.41667	.39063	.26042	.33854	.18229	.28646	.20833	2.99479
.5 /	.39063	.20833	.39063	.20833	.31250	.39063	.31250	.46875	.28646	.28646	3.25821
.6 /	.33854	.33854	.52083	.28646	.36458	.28646	.39063	.33854	.28646	.49479	3.64583
.7 /	.23437	.39063	.23437	.28646	.20833	.23437	.41667	.33854	.33854	.26042	2.94271
.8 /	.46875	.26042	.31250	.28646	.31250	.31250	.33854	.33854	.26042	.23437	3.12500
.9 /	.36458	.39063	.49479	.23437	.26042	.33854	.28646	.28646	.39063	.31250	3.35937
1.0 /	.33854	.41667	.31250	.39063	.49479	.36458	.36458	.36458	.39063	.46875	3.90625
1.1 /	.33854	.41667	.54687	.36458	.54687	.62500	.33854	.52083	.67700	.59896	4.97396
1.2 /	.44271	.83333	.85937	.85937	1.04167	1.11979	1.64062	2.83125	.93750	.15625	9.92187
1.3 /	0.00000	0.00000	0.00000	0.00000	0.00000	0.00000	0.00000	0.00000	0.00000	0.00000	0.00000
1.4 /	0.00000	0.00000	0.00000	0.00000	0.00000	0.00000	0.00000	0.00000	0.00000	0.00000	0.00000

TOTAL DATA POINTS = 3840

V2 FILE 24 TAPE DT1-2  
 PERCENTAGES OF TIME WITHIN VOLTAGE INTERVALS

INTERVAL MIDPOINTS	.09	.08	.07	.06	.05	.04	.03	.02	.01	.00	TOTAL
-1.4 /	0.00000	0.00000	0.00000	0.00000	.02604	0.00000	.07812	.57292	1.79687	1.64862	4.11458
-1.3 /	1.38021	1.04167	.91146	.57292	.72917	.57292	.54823	.53168	.61835	.53884	7.44344
-1.2 /	.78437	.54932	.51107	.43781	.43498	.49181	.32606	.40554	.43023	.53847	4.98885
-1.1 /	.45424	.50496	.45627	.27059	.35037	.29663	.45627	.40012	.26991	.34736	3.88642
-1.0 /	.21986	.24116	.34532	.35007	.32132	.26923	.29256	.26923	.16371	.50225	2.97472
-.9 /	.27195	.27059	.27127	.18843	.21444	.42548	.24387	.24251	.19043	.39741	2.71634
-.8 /	.27127	.26788	.37204	.39537	.21376	.37543	.23912	.18772	.16303	.37543	2.86186
-.7 /	.29256	.26923	.34663	.13563	.42548	.16710	.26788	.27059	.32199	.21444	2.71159
-.6 /	.19653	.42752	.18975	.34736	.21512	.26855	.29527	.19314	.16235	.40487	2.70047
-.5 /	.21512	.21308	.13835	.32403	.32267	.32132	.31793	.29867	.11163	.23777	2.50054
-.4 /	.23912	.21512	.26788	.21647	.24387	.13970	.13970	.29324	.26720	.24183	2.26413
-.3 /	.24319	.16574	.26720	.26788	.26720	.16371	.26991	.13699	.21444	.24319	2.23945
-.2 /	.26652	.24183	.16333	.16642	.32064	.21172	.32471	.26516	.16439	.29188	2.41631
-.1 /	.29527	.26720	.26652	.24319	.24251	.21579	.19246	.26991	.21715	.31725	2.52726
-0.0 /	.19343	.19246	.24251	.24319	.18975	.16439	.44949	.34871	.16710	.37882	2.56687
.00 /	.29256	.26991	.21308	.24319	.21851	.26652	.39888	.29731	.11095	.231811	2.31811
.1 /	.24387	.16235	.34871	.26855	.13970	.29460	.34465	.29595	.11434	.29324	2.50597
.2 /	.23777	.29527	.14377	.31863	.21647	.21376	.21715	.18975	.26788	.21579	2.31822
.3 /	.32403	.42141	.21715	.21715	.16371	.49886	.31793	.18975	.30002	.13428	2.78429
.4 /	.21851	.42413	.26652	.24523	.37476	.31928	.45152	.23912	.13767	.29188	2.96861
.5 /	.40080	.23980	.27059	.39605	.21647	.29663	.29460	.45492	.18975	.37284	3.13165
.6 /	.32132	.32132	.37815	.18975	.45220	.31996	.29663	.45152	.37204	.22122	3.32411
.7 /	.39673	.34871	.50090	.24183	.57834	.03215	.50564	.34736	.37343	.37137	3.69642
.8 /	.35075	.39741	.39876	.60642	.45085	.55501	.39944	.50381	.29324	.39673	4.35221
.9 /	.34804	.42684	.48164	.50090	.52762	.55173	.45017	.45017	.60913	.60710	4.98332
1.0 /	.37340	.55773	.58105	.45288	.66393	.68658	.76470	.84283	.84351	.68929	6.45689
1.1 /	.65986	1.02648	1.00382	1.07720	1.47257	1.39648	1.93590	1.81044	1.66617	1.34272	13.33266
1.2 /	.89695	.43837	.13050	.07446	.02713	.02916	.04272	.05298	.02441	.08487	1.69867
1.3 /	0.00000	0.00000	0.00000	0.00000	0.00000	0.00000	0.00000	0.00000	0.00000	0.00000	0.00000
1.4 /	0.00000	0.00000	0.00000	0.00000	0.00000	0.00000	0.00000	0.00000	0.00000	0.00000	0.00000

TOTAL DATA POINTS = 3840

V1 FILE 42 TAPE DTT-2  
 PERCENTAGES OF TIME WITHIN VOLTAGE INTERVALS

INTERVAL  
 MIDPOINTS

	.09	.08	.07	.06	.05	.04	.03	.02	.01	.00	TOTAL
-1.4 /	0.00000	0.00000	.05208	.54687	1.27604	2.16146	1.22396	1.04167	1.01962	1.11979	8.43750
-1.3 /	.46875	.70312	.59896	.62500	.49479	.67708	.49479	.59896	.28646	.52083	5.46875
-1.2 /	.41667	.52083	.31250	.26042	.39063	.41667	.41667	.46875	.33854	.39063	3.93229
-1.1 /	.39163	.39163	.41667	.39063	.39063	.33854	.33854	.44271	.36458	.33854	3.80200
-1.0 /	.39063	.31250	.31250	.28646	.49479	.39063	.20833	.41667	.28646	.31250	3.41146
-.9 /	.41667	.31250	.28646	.26042	.33854	.26042	.28646	.36458	.26042	.23437	3.02883
-.8 /	.26042	.33854	.23437	.23437	.26042	.33854	.28646	.18229	.26042	.23437	2.68229
-.7 /	.28646	.15625	.26042	.20833	.15625	.41667	.15625	.33854	.28646	.28646	2.46792
-.6 /	.33854	.19229	.28646	.20833	.31250	.13021	.31250	.20833	.26042	.28646	2.52604
-.5 /	.20833	.31250	.20833	.20833	.28646	.20833	.28646	.18229	.23437	.26042	2.39883
-.4 /	.28646	.20833	.28646	.15625	.26042	.26042	.26042	.23437	.33854	.18229	2.47396
-.3 /	.28646	.18229	.18229	.31250	.23437	.23437	.18229	.20833	.36458	.20833	2.39883
-.2 /	.15625	.31250	.23437	.23437	.23437	.23437	.18229	.20833	.15625	.15625	2.26562
-.1 /	.20833	.28646	.20833	.20833	.18229	.28646	.15625	.23437	.26042	.23437	2.26562
-0.0 /	.26042	.18229	.20833	.26042	.23437	.20833	.26042	.13021	.28646	.44271	2.47396
0.0 /											
.1 /	.18229	.15625	.23437	.20833	.15625	.28646	.18229	.20833	.23437	.28646	1.95312
.2 /	.41667	.07812	.26042	.20833	.31250	.18229	.28646	.20833	.18229	.23437	2.21354
.3 /	.23437	.20833	.28646	.20833	.20833	.33854	.18229	.18229	.26042	.26042	2.47396
.4 /	.26342	.20833	.23437	.31250	.13021	.26042	.33854	.26042	.20833	.20833	2.36979
.5 /	.28646	.10417	.31250	.26042	.28646	.20833	.13021	.39063	.23437	.20833	2.42187
.6 /	.23437	.36458	.18229	.23437	.28646	.26042	.20833	.28646	.18229	.33854	2.57812
.7 /	.20833	.28646	.20833	.23437	.20833	.31250	.36458	.15625	.23437	.28646	2.50000
.8 /	.26342	.33854	.28646	.18229	.28646	.33854	.26042	.31250	.20833	.28646	2.76842
.9 /	.31250	.28646	.41667	.36458	.31250	.33854	.18229	.44271	.31250	.31250	3.28125
1.0 /	.33854	.36458	.36458	.33854	.33854	.31250	.33854	.39063	.41667	.28646	3.48958
1.1 /	.36458	.36458	.44271	.44271	.28646	.36458	.39063	.52083	.33854	.46875	3.98437
1.2 /	.26342	.46875	.59896	.49479	.39063	.41667	.36458	.52083	.49479	.44271	4.45312
1.3 /	.54687	.62500	.75521	.54687	.67708	.80729	1.09375	1.06771	1.19792	1.66667	8.98437
1.4 /	2.13542	1.66667	.31250	0.00000	0.00000	0.00000	0.00000	0.00000	0.00000	0.00000	4.11458

TOTAL DATA PCINTS = 3840

V2 FILE 42 TAPE DTT-2  
 PERCENTAGES OF TIME WITHIN VOLTAGE INTERVALS

INTERVAL  
 MIDPCINTS

	.09	.08	.07	.06	.05	.04	.03	.02	.01	.00	TOTAL
-1.4 /	0.00000	0.00000	.20969	.87362	1.62177	1.98337	1.02146	1.19900	.91187	1.07003	8.09160
-1.3 /	.53304	.56519	.69268	.53711	.66393	.59055	.58580	.48435	.26788	.58848	5.58708
-1.2 /	.50564	.50836	.26855	.39741	.27059	.55773	.40148	.45492	.34738	.45288	4.16493
-1.1 /	.34871	.37476	.45356	.42684	.34871	.37340	.42548	.39307	.34804	.47757	3.92714
-1.0 /	.27059	.26855	.37272	.42413	.35143	.37476	.37001	.34939	.29392	.45085	3.52636
-.9 /	.34939	.24251	.34600	.26721	.21715	.31928	.34600	.34804	.29324	.21444	2.94325
-.8 /	.29324	.29527	.24048	.29256	.34532	.24319	.24183	.21308	.37137	.21579	2.75214
-.7 /	.24183	.26449	.18907	.18772	.21240	.42752	.18636	.34736	.26788	.29121	2.61583
-.6 /	.21715	.23912	.18975	.29188	.29460	.18568	.26855	.26584	.31928	.16371	2.43557
-.5 /	.34397	.24251	.29188	.13563	.29392	.29188	.21579	.21308	.24048	.21512	2.48427
-.4 /	.39808	.21376	.21579	.18636	.34532	.16303	.26720	.31860	.21715	.26516	2.59047
-.3 /	.29392	.21308	.16100	.29460	.21444	.24048	.18704	.31753	.29595	.23980	2.45822
-.2 /	.29053	.16439	.18840	.29256	.18840	.39673	.21647	.08219	.21240	.34465	2.37671
-.1 /	.21376	.18975	.21984	.26584	.13496	.26788	.18636	.26652	.24116	.26652	2.27254
0.0 /	.21512	.21308	.21376	.26720	.31860	.16168	.16303	.28985	.16371	.58445	2.59047

	.00	.01	.02	.03	.04	.05	.06	.07	.08	.09	TOTAL
0.0 /		.18636	.21444	.16168	.26449	.21579	.26516	.18772	.21444	.26788	1.97795
.1 /	.29121	.24048	.29324	.18423	.23912	.37204	.13563	.26584	.36933	.11027	2.48139
.2 /	.19314	.26245	.24116	.23980	.21647	.34329	.21579	.23980	.21512	.31928	2.48630
.3 /	.24944	.23980	.16371	.26584	.26584	.13902	.31725	.23912	.26788	.24048	2.37942
.4 /	.13699	.39605	.16235	.32064	.26381	.21512	.32132	.26720	.23980	.18772	2.51899
.5 /	.24183	.21105	.26855	.31928	.13767	.23980	.31589	.32267	.18840	.31793	2.56347
.6 /	.29256	.26991	.13496	.26652	.31936	.31928	.10959	.34600	.23912	.21715	2.51506
.7 /	.29188	.21579	.23980	.31860	.26584	.26855	.32199	.21240	.21444	.29392	2.64323
.8 /	.34532	.29527	.21579	.18704	.29392	.39944	.24116	.32064	.29188	.39888	2.98855
.9 /	.26855	.31996	.42752	.34804	.19043	.37340	.44746	.24590	.26855	.47689	3.36678
1.0 /	.21715	.40012	.47824	.34736	.19111	.42480	.39944	.42684	.37543	.39888	3.65858
1.1 /	.32199	.37408	.45424	.29799	.52829	.40012	.40080	.35211	.58173	.29867	4.01801
1.2 /	.47553	.42887	.48435	.50768	.45288	.32335	.58241	.45627	.53372	.68861	4.93368
1.3 /	.66528	.58919	.74883	.71737	1.13742	.90644	1.30452	1.51218	1.59370	1.55382	10.72876
1.4 /	1.09728	.69444	.08626	.02604	0.00000	0.00000	0.00000	0.00000	0.00000	0.00000	1.90403

TOTAL DATA POINTS = 3843

V1 FILE 43 TAPE DTT-2  
 PERCENTAGES OF TIME WITHIN VOLTAGE INTERVALS

INTERVAL  
 MICROPOINTS

	.09	.08	.07	.06	.05	.04	.03	.02	.01	.00	TOTAL
-1.4 /	0.00000	0.00000	.05208	.52083	1.61458	2.18750	1.19792	1.27604	.75521	.88542	8.48958
-1.3 /	.75521	.72917	.67708	.62500	.62500	.46875	.52083	.44271	.46875	.57292	5.88542
-1.2 /	.41667	.26042	.41667	.52083	.36458	.31250	.65104	.44271	.33854	.33854	4.06250
-1.1 /	.31250	.52083	.36458	.36458	.23437	.44271	.36458	.36458	.39063	.33854	3.69792
-1.0 /	.20833	.44271	.33854	.36458	.33854	.36458	.26042	.31250	.39063	.41667	3.43750
-.9 /	.18229	.31250	.33854	.33854	.28646	.41667	.26042	.28646	.26042	.31250	2.99479
-.8 /	.20833	.36458	.31250	.33854	.28646	.20833	.23437	.23437	.41667	.18229	2.78646
-.7 /	.23437	.20833	.28646	.20833	.26042	.33854	.28646	.20833	.31250	.18229	2.52604
-.6 /	.20833	.26042	.33854	.31250	.15625	.33854	.10417	.18229	.44271	.15625	2.50000
-.5 /	.36458	.26042	.15625	.18229	.26042	.18229	.23437	.33854	.18229	.10417	2.26562
-.4 /	.23437	.23437	.20833	.28646	.31250	.31250	.20833	.20833	.18229	.23437	2.42187
-.3 /	.26042	.20833	.26042	.31250	.15625	.28646	.20833	.20833	.31250	.23437	2.44792
-.2 /	.23437	.23437	.23437	.20833	.23437	.13021	.23437	.26042	.20833	.33854	2.31771
-.1 /	.18229	.13021	.31250	.15625	.26042	.26042	.28646	.15625	.07812	.28646	2.10937
-0.0 /	.28646	.28646	.10417	.28646	.28646	.18229	.18229	.10417	.20833	.52083	2.44792
	.00	.01	.02	.03	.04	.05	.06	.07	.08	.09	TOTAL
0.0 /		.18229	.36458	.05208	.31250	.31250	.13021	.23437	.15625	.28646	2.03125
.1 /	.28646	.28646	.15625	.28646	.20833	.28646	.20833	.26042	.13021	.28646	2.39583
.2 /	.28646	.20833	.23437	.26042	.23437	.33854	.26042	.10417	.23437	.31250	2.55260
.3 /	.18229	.28646	.23437	.15625	.15625	.33854	.33854	.23437	.20833	.18229	2.31771
.4 /	.23437	.23437	.26042	.18229	.41667	.10417	.28646	.31250	.20833	.13021	2.36979
.5 /	.31250	.23437	.15625	.39063	.28646	.15625	.28646	.15625	.20833	.23437	2.42187
.6 /	.26042	.23437	.18229	.26042	.26042	.18229	.36458	.15625	.36458	.18229	2.44792
.7 /	.23437	.20833	.44271	.18229	.39063	.18229	.20833	.18229	.39063	.44271	2.73437
.8 /	.20833	.15625	.23437	.23437	.28646	.31250	.28646	.28646	.36458	.31250	2.68229
.9 /	.26042	.33854	.23437	.36458	.33854	.26042	.31250	.39063	.33854	.33854	3.17708
1.0 /	.31250	.33854	.26042	.26042	.41667	.36458	.31250	.31250	.41667	.41667	3.41146
1.1 /	.54687	.28646	.23437	.49479	.28646	.52083	.52083	.28646	.33854	.36458	3.88021
1.2 /	.49479	.44271	.41667	.28646	.46875	.52083	.44271	.33854	.54687	.65104	4.60937
1.3 /	.49479	.72917	.52083	.80729	.54687	.80729	.91146	1.38021	1.11979	1.53646	8.85417
1.4 /	1.71875	1.64062	.33854	.02604	0.00000	0.00000	0.00000	0.00000	0.00000	0.00000	3.72396

TOTAL DATA PCINTS = 3840

V2 FILE 43 TAPE DTT-2  
 PERCENTAGES OF TIME WITHIN VOLTAGE INTERVALS

INTERVAL MIDPOINTS	.09	.08	.07	.06	.05	.04	.03	.02	.01	.00	TOTAL
-1.4 /	0.0000	0.0000	.23573	.58648	2.46392	1.59342	1.22911	1.12698	.95717	.88243	9.07525
-1.3 /	.69675	.77420	.61659	.61523	.61523	.53304	.40419	.55840	.24658	.79617	5.85639
-1.2 /	.34939	.42345	.45356	.40419	.47824	.42480	.43362	.50632	.37340	.32132	4.16829
-1.1 /	.32064	.43023	.45220	.40012	.29256	.37611	.42616	.45220	.32267	.32132	3.79422
-1.0 /	.29184	.24590	.47757	.32199	.34736	.26991	.44949	.37272	.34871	.34939	3.47493
-.9 /	.31725	.26855	.26923	.39944	.34600	.37543	.18907	.26788	.24116	.37272	3.04674
-.8 /	.31793	.29595	.52897	.26923	.18975	.23900	.16235	.37069	.37543	.18704	2.93715
-.7 /	.21444	.21376	.31996	.21376	.31996	.39741	.13902	.18975	.39605	.21647	2.61787
-.6 /	.18772	.31928	.26923	.08626	.36865	.34736	.18500	.31725	.37611	.13428	2.59115
-.5 /	.26991	.21512	.31657	.21308	.24116	.13496	.24048	.16507	.23912	.21105	2.24650
-.4 /	.18840	.31860	.13563	.37204	.26855	.29460	.21376	.23980	.18704	.31860	2.53703
-.3 /	.29324	.26584	.16303	.34668	.16032	.31996	.21376	.23980	.24251	.26652	2.51166
-.2 /	.31860	.08423	.21444	.16168	.26652	.21172	.34465	.21512	.34397	.19111	2.35202
-.1 /	.23912	.10756	.24251	.31657	.13699	.24116	.29392	.29053	.10620	.11163	2.08618
0.0 /	.29392	.26788	.26313	.11163	.34600	.26516	.23912	.15896	.13563	.40419	2.48562
	.00	.01	.02	.03	.04	.05	.06	.07	.08	.09	TOTAL
0.0 /		.31725	.34804	.20969	.24251	.19043	.18568	.29256	.18636	.18975	2.16227
.1 /	.31996	.26788	.31657	.21579	.29188	.11163	.16168	.31928	.21172	.29392	2.51031
.2 /	.24183	.26584	.29256	.29324	.21444	.26923	.18907	.23709	.24251	.34668	2.59290
.3 /	.34329	.13767	.34465	.10824	.18636	.34736	.24319	.18840	.31793	.29121	2.50827
.4 /	.24048	.24148	.13699	.23912	.21918	.34125	.37204	.21647	.18772	.34377	2.43150
.5 /	.34668	.26652	.18636	.21851	.18975	.34261	.29392	.21240	.10959	.31860	2.48494
.6 /	.34532	.13631	.16100	.42345	.21512	.31725	.24387	.13428	.37408	.21308	2.56375
.7 /	.25652	.42209	.14174	.23912	.11434	.29121	.29188	.23912	.31928	.35007	2.67537
.8 /	.26584	.21240	.18840	.21444	.37204	.45085	.18975	.37204	.21783	.29460	2.77810
.9 /	.42345	.34736	.24048	.40012	.29527	.26720	.21647	.40080	.37340	.26923	3.23378
1.0 /	.32064	.39944	.37137	.26720	.58377	.37408	.42480	.32064	.27127	.34939	3.68259
1.1 /	.27466	.50225	.37069	.35143	.55433	.40419	.40419	.39808	.42548	.47824	4.16355
1.2 /	.40351	.53236	.37543	.37204	.55908	.43023	.50632	.45152	.63924	.53779	4.88754
1.3 /	.61184	.72211	.76877	.90644	.84757	1.16688	1.09144	1.18178	1.40937	1.91981	10.62120
1.4 /	.85205	.66772	.06090	.12672	0.00000	0.00000	0.00000	0.00000	0.00000	0.00000	1.66739

TOTAL DATA POINTS = 3840

V1 FILE 44 TAPE DTT-2  
 PERCENTAGES OF TIME WITHIN VOLTAGE INTERVALS

INTERVAL  
 MIDPOINTS

	.09	.08	.07	.06	.05	.04	.03	.02	.01	.00	TOTAL
-1.4 /	0.00000	0.00000	0.00000	0.00000	.10417	1.01562	1.79687	1.64062	1.53646	.83333	6.92708
-1.3 /	.65104	.93750	.78125	.70312	.44271	.73312	.65104	.41667	.49479	.57292	6.35417
-1.2 /	.41667	.54687	.33854	.52083	.49479	.33854	.41667	.49479	.36458	.28646	4.21875
-1.1 /	.57292	.39063	.39063	.39063	.39063	.31250	.39063	.46875	.31250	.44271	4.06250
-1.0 /	.31250	.28646	.44271	.23437	.46875	.23437	.31250	.46875	.28646	.33854	3.38542
-.9 /	.41667	.28646	.21833	.15625	.39063	.44271	.31250	.18229	.26042	.20833	2.86458
-.8 /	.31250	.46875	.18229	.28646	.33854	.23437	.33854	.39063	.36458	.18229	3.09096
-.7 /	.13021	.39063	.28646	.23437	.23437	.23437	.33854	.41667	.18229	.20833	2.65625
-.6 /	.15625	.15625	.23437	.41667	.18229	.23437	.36458	.89208	.33854	.26042	2.39583
-.5 /	.23437	.26042	.15625	.18229	.13021	.46875	.33854	.20833	.33854	.26042	2.57312
-.4 /	.18229	.28833	.26042	.23437	.33854	.26042	.26042	.13021	.36458	.18229	2.42187
-.3 /	.31250	.28646	.23437	.20833	.28646	.26042	.36458	.33854	.26042	.05208	2.63417
-.2 /	.28833	.20833	.33854	.28833	.23437	.21833	.15625	.20833	.26042	.15625	2.18750
-.1 /	.36458	.13417	.10417	.31250	.18229	.26042	.28646	.18229	.13021	.15625	2.08333
0.0 /	.28833	.23437	.26042	.31250	.13021	.20833	.20833	.26042	.18229	.62500	2.63821
0.0 /	.00	.01	.02	.03	.04	.05	.06	.07	.08	.09	TOTAL
0.0 /		.13021	.26042	.20833	.20833	.33854	.23437	.23437	.23437	.21833	2.85729
.1 /	.23437	.20833	.31250	.18229	.18229	.26042	.18229	.28646	.26042	.26042	2.36979
.2 /	.13417	.28646	.18229	.18229	.36458	.23437	.23437	.10417	.33854	.13021	2.16146
.3 /	.26042	.28646	.25042	.23437	.26042	.26042	.20833	.26042	.26042	.31250	2.60417
.4 /	.13021	.20833	.18229	.20833	.18229	.20833	.33854	.26042	.15625	.23437	2.18937
.5 /	.18229	.15625	.28646	.31250	.13021	.23437	.28646	.23437	.26042	.18229	2.26562
.6 /	.26042	.18229	.26042	.36458	.33854	.18229	.36458	.20833	.15625	.44271	2.76042
.7 /	.26042	.23437	.39063	.13021	.13021	.28646	.28646	.46875	.23437	.28646	2.70833
.8 /	.15625	.26042	.41667	.20833	.20833	.31250	.28646	.18229	.41667	.23437	2.68229
.9 /	.26042	.31250	.41667	.33854	.18229	.36458	.46875	.44271	.23437	.33854	3.35937
1.0 /	.36458	.57292	.23437	.28646	.26042	.44271	.33854	.39063	.41667	.41667	3.72396
1.1 /	.39063	.28646	.31250	.46875	.46875	.39063	.33854	.39063	.49479	.46875	4.01042
1.2 /	.39063	.54687	.31250	.39063	.70312	.46875	.33854	.62500	.54687	.59896	4.92187
1.3 /	.62500	.59896	.70312	.75521	.78125	.78125	.98958	1.25000	1.25000	2.21354	9.94792
1.4 /	1.45833	.39063	0.00000	0.00000	0.00000	0.00000	0.00000	0.00000	0.00000	0.00000	1.84896

TOTAL DATA POINTS = 3840



V2 FILE 44 TAPE OTT-2  
 PERCENTAGES OF TIME WITHIN VOLTAGE INTERVALS

INTERVAL  
 MIDPOINTS

	.09	.08	.07	.06	.05	.04	.03	.02	.01	.00	TOTAL
-1.4 /	0.00000	0.00000	.32604	.07812	.88813	1.66707	1.68742	1.47502	1.08168	.93316	7.83664
-1.3 /	.98050	.64941	.59326	.74748	.55843	.48706	.45966	.71398	.37747	.58784	6.15506
-1.2 /	.58377	.35278	.47757	.37815	.35143	.50361	.47960	.48164	.45220	.26788	4.32861
-1.1 /	.43159	.32267	.50496	.47892	.37476	.21647	.60913	.24658	.37272	.42820	3.98650
-1.0 /	.34668	.39808	.35007	.37069	.45492	.29256	.42480	.27262	.16371	.37340	3.44754
- .9 /	.37543	.26788	.39605	.13428	.45288	.32403	.16439	.39537	.34532	.29188	3.14752
- .8 /	.29460	.19450	.21308	.37204	.24319	.34465	.26923	.34871	.24387	.31725	2.84112
- .7 /	.23777	.45288	.24183	.34465	.21444	.26652	.26923	.34939	.18704	.34397	2.90771
- .6 /	.23844	.26449	.29256	.16711	.21308	.31860	.29595	.26177	.21715	.24116	2.51031
- .5 /	.21444	.31928	.26449	.29121	.28985	.14242	.29527	.29188	.19111	.29324	2.59318
- .4 /	.18704	.29188	.16303	.34465	.34736	.18907	.18907	.39402	.24387	.10891	2.45890
- .3 /	.26855	.34600	.29256	.16168	.29392	.21512	.19179	.29527	.21512	.18365	2.46365
- .2 /	.23981	.31793	.16507	.21376	.39673	.13563	.26449	.26584	.24116	.23844	2.47884
- .1 /	.19179	.26313	.13292	.16439	.26516	.24116	.16371	.26516	.18568	.26449	2.13759
-0.0 /	.18772	.24048	.26720	.29460	.18568	.10959	.21376	.24116	.29121	.53711	2.56850
	.00	.01	.02	.03	.04	.05	.06	.07	.08	.09	TOTAL
0.0 /		.15964	.39741	.13563	.26584	.24319	.24048	.24048	.21444	.18772	2.08483
.1 /	.26652	.21376	.26855	.29121	.21308	.29324	.23912	.31996	.29324	.18907	2.58775
.2 /	.13292	.18975	.26516	.23912	.24387	.24048	.21444	.28917	.21715	.23777	2.26983
.3 /	.21512	.11163	.31928	.18844	.31928	.18907	.34397	.21512	.21512	.29460	2.41157
.4 /	.15964	.26584	.23912	.29188	.13496	.29188	.32132	.31928	.29053	.18840	2.50285
.5 /	.05683	.23844	.29392	.29460	.28985	.26652	.29392	.21444	.29324	.21308	2.45483
.6 /	.18907	.36933	.21512	.21783	.19111	.31725	.26991	.31793	.26449	.24590	2.59793
.7 /	.21512	.21444	.19246	.44611	.15964	.37204	.11163	.40283	.24048	.29392	2.64865
.8 /	.23844	.50157	.27127	.26584	.26584	.21647	.37204	.31725	.24523	.39673	3.09068
.9 /	.29324	.29460	.24523	.42548	.26516	.50429	.29867	.32403	.39673	.24319	3.29061
1.0 /	.40012	.30138	.42277	.31996	.50157	.48028	.37340	.47892	.27127	.24523	3.79489
1.1 /	.50496	.52829	.37272	.50700	.27262	.37476	.45152	.45288	.48164	.37679	4.32319
1.2 /	.37476	.50903	.58105	.37476	.53914	.63721	.45152	.61523	.58716	.56247	5.23234
1.3 /	.77148	.77081	1.00789	.80092	.85368	1.32243	1.32785	1.69922	1.43880	.94306	10.93614
1.4 /	.32444	.14038	.35208	0.00000	0.00000	0.00000	0.00000	0.00000	0.00000	0.00000	.51690

66

TOTAL DATA POINTS = 3840

V1 FILE 45 TAPE OTT-2  
 PERCENTAGES OF TIME WITHIN VOLTAGE INTERVALS

INTERVAL MIDPOINTS	.09	.08	.07	.06	.05	.04	.03	.02	.01	.00	TOTAL
-1.4 /	0.00000	0.00000	0.00000	0.00000	0.00000	0.00000	0.39063	.83333	2.05729	1.35417	4.63542
-1.3 /	.98958	.98958	.93750	.78125	.85937	.75521	.62500	.62500	.65104	.62500	7.83854
-1.2 /	.44271	.49479	.70112	.44271	.57292	.39063	.39063	.70312	.39063	.39063	4.92187
-1.1 /	.52083	.33854	.44271	.41667	.46875	.36458	.41667	.31250	.33854	.31250	3.93229
-1.0 /	.41667	.41667	.36458	.41667	.28646	.26042	.39063	.26042	.31250	.20833	3.33333
-.9 /	.31250	.28646	.31250	.28646	.31250	.18229	.20833	.36458	.41667	.15625	2.83854
-.8 /	.26042	.26042	.33854	.36458	.15625	.23437	.31250	.31250	.23437	.28646	2.76042
-.7 /	.31250	.13021	.36458	.28646	.13021	.41667	.36458	.13021	.26042	.41667	2.81250
-.6 /	.20833	.28646	.26042	.20833	.31250	.33854	.15625	.36458	.31250	.28646	2.73437
-.5 /	.26042	.18229	.26042	.13021	.33854	.28646	.18229	.33854	.18229	.26042	2.42187
-.4 /	.31250	.26042	.13021	.28646	.18229	.10417	.23437	.49479	.15625	.28646	2.44792
-.3 /	.33954	.15625	.15625	.20833	.26042	.28646	.20833	.15625	.31250	.18229	2.26562
-.2 /	.28646	.23437	.26042	.28646	.23437	.33854	.28646	.23437	.26042	.28646	2.70833
-.1 /	.23437	.26042	.20833	.23437	.28646	.26042	.18229	.20833	.15625	.10417	2.13542
0.0 /	.31250	.20833	.23437	.23437	.33854	.26042	.23437	.18229	.23437	.41667	2.65625
0.0 /	.00	.01	.02	.03	.04	.05	.06	.07	.08	.09	TOTAL
0.0 /		.20833	.07812	.36458	.15625	.10417	.23437	.20833	.23437	.26042	1.84896
.1 /	.28646	.13021	.13021	.39063	.41667	.23437	.18229	.31250	.33854	.33854	2.76042
.2 /	.18229	.13021	.20833	.23437	.23437	.18229	.20833	.20833	.26042	.26042	2.18937
.3 /	.20833	.23437	.23437	.20833	.36458	.33854	.13021	.23437	.18229	.28646	2.42187
.4 /	.31250	.13021	.33854	.36458	.26042	.20833	.26042	.36458	.26042	.31250	2.81250
.5 /	.26042	.20833	.10417	.33854	.31250	.33854	.13021	.15625	.23437	.20833	2.29187
.6 /	.44271	.23437	.20833	.23437	.20833	.31250	.26042	.15625	.31250	.28646	2.65625
.7 /	.13021	.26042	.28646	.39063	.23437	.39063	.36458	.20833	.13021	.20833	2.60417
.8 /	.31250	.31250	.31250	.31250	.23437	.23437	.49479	.13021	.23437	.26042	2.83854
.9 /	.28646	.36458	.39063	.46875	.26042	.31250	.49479	.13021	.39063	.39063	3.48958
1.0 /	.41667	.36458	.39063	.13021	.36458	.44271	.28646	.44271	.33854	.36458	3.54167
1.1 /	.41667	.59896	.36458	.44271	.39063	.41667	.41667	.49479	.49479	.36458	4.40104
1.2 /	.59896	.33854	.49479	.33854	.44271	.57292	.52083	.75521	.75521	.39063	5.20833
1.3 /	.88542	.96354	.91146	.85937	1.06771	.75521	1.48437	1.22396	1.90104	.52083	10.57292
1.4 /	0.00000	0.00000	0.00000	0.00000	0.00000	0.00000	0.00000	0.00000	0.00000	0.00000	0.00000

100

TOTAL DATA POINTS = 3640

V2 FILE 45 TAPE OTT-2  
 PERCENTAGES OF TIME WITHIN VOLTAGE INTERVALS

INTERVAL MIDPOINTS	.09	.08	.07	.06	.05	.04	.03	.02	.01	.00	TOTAL
-1.4 /	0.00000	0.00000	0.00000	0.00000	.26042	.62500	1.83309	1.84462	1.56399	1.02465	7.15196
-1.3 /	1.09348	.75494	.67546	.74951	.69946	.48842	.45898	.71940	.38154	.64128	6.66246
-1.2 /	.58445	.45559	.35685	.55840	.56179	.40680	.47892	.53914	.29663	.27859	4.50317
-1.1 /	.50836	.52965	.35007	.42752	.50700	.21783	.53168	.29460	.39944	.42488	4.18895
-1.0 /	.37543	.27127	.40012	.34939	.37204	.37137	.34871	.24116	.39876	.34397	3.47222
-.9 /	.34668	.21579	.32064	.21579	.34668	.18704	.21376	.34804	.42752	.34261	2.96455
-.8 /	.24116	.18907	.34736	.16574	.29053	.34465	.19043	.29460	.24048	.26788	2.57189
-.7 /	.37272	.28985	.21743	.16371	.23777	.32335	.26991	.34193	.26720	.29731	2.78158
-.6 /	.26584	.21579	.21512	.18772	.13835	.42548	.34261	.19179	.21647	.18975	2.38392
-.5 /	.31924	.21308	.37137	.23777	.29527	.29392	.39537	.13902	.21308	.24116	2.71932
-.4 /	.21647	.26720	.21172	.18975	.13496	.23709	.26652	.14309	.26449	.39808	2.32937
-.3 /	.13902	.34261	.13428	.31793	.24116	.24183	.26584	.16032	.24251	.21308	2.29858
-.2 /	.26788	.21444	.21512	.24193	.16235	.32132	.21579	.21444	.21512	.34600	2.41420
-.1 /	.21444	.18907	.18772	.29256	.21579	.29324	.21308	.18772	.18636	.31521	2.29519
0.0 /	.24251	.31793	.21444	.21444	.13902	.29324	.39673	.23912	.29256	.40148	2.75146
	.00	.01	.02	.03	.04	.05	.06	.07	.08	.09	TOTAL
0.0 /		.31793	.23641	.24387	.21240	.18500	.31860	.29188	.26652	.38491	2.15752
.1 /	.21579	.28985	.18568	.40080	.19314	.21444	.36933	.11230	.32132	.18907	2.46772
.2 /	.29121	.26381	.18772	.31860	.16235	.31725	.23980	.26584	.26720	.24116	2.55493
.3 /	.18772	.31860	.29256	.29188	.26991	.21715	.21172	.37069	.29121	.16371	2.61515
.4 /	.21647	.18756	.29527	.24387	.21512	.16168	.37137	.21783	.16303	.16439	2.15658
.5 /	.24116	.31793	.21105	.26923	.19043	.37340	.26381	.34261	.13631	.26584	2.61176
.6 /	.14174	.26652	.47418	.21444	.26584	.29460	.21512	.34261	.29460	.29392	2.80355
.7 /	.23777	.29324	.21579	.37476	.31860	.29663	.21783	.34397	.39402	.29188	2.98448
.8 /	.21647	.24251	.37272	.45085	.24348	.24048	.35143	.23777	.39673	.31928	3.06871
.9 /	.31996	.37408	.32267	.29867	.31928	.45085	.32539	.34193	.53101	.27059	3.55442
1.0 /	.27127	.34804	.24455	.42006	.45220	.37611	.34600	.42820	.37340	.42616	3.68990
1.1 /	.53168	.39206	.53033	.35007	.45288	.50564	.58377	.42955	.45559	.53033	4.67190
1.2 /	.51039	.58173	.55976	.79007	.84486	.48367	.56044	.61863	.72279	.68913	6.28147
1.3 /	.56993	.98863	.96124	1.50675	1.66843	1.55613	1.28866	.63883	.25784	.83961	9.46804
1.4 /	.02604	0.00000	0.00000	0.00000	0.00000	0.00000	0.00000	0.00000	0.00000	0.00000	.02604

TOTAL DATA POINTS = 3840

V1 FILE 46 TAPE DTT-2  
PERCENTAGES OF TIME WITHIN VOLTAGE INTERVALS

INTERVAL MIDPOINTS	.09	.08	.07	.06	.05	.04	.03	.02	.01	.00	TOTAL
-1.4 /	0.00000	0.00000	0.00000	0.00000	0.00000	0.00000	0.00000	0.00000	0.00000	.02604	.02604
-1.3 /	.33854	1.45833	2.05729	1.32812	1.06771	.57292	.80729	.65104	.62500	.52003	9.42708
-1.2 /	.59896	.54687	.52083	.52083	.41667	.49479	.44271	.36458	.39063	.44271	4.73958
-1.1 /	.49479	.59896	.49479	.36458	.65104	.65104	.39063	.46875	.28646	.41667	4.81771
-1.0 /	.59896	.26042	.28646	.33854	.33854	.52083	.33854	.31250	.46875	.33854	3.80208
-.9 /	.18229	.39063	.36458	.28646	.33854	.33854	.46875	.44271	.31250	.15625	3.20125
-.8 /	.23437	.33854	.41667	.31250	.36458	.26042	.28646	.33854	.36458	.26042	3.17708
-.7 /	.18229	.20833	.36458	.28646	.18229	.31250	.26042	.28646	.18229	.28646	2.55208
-.6 /	.20833	.39063	.36458	.20833	.41667	.15625	.28646	.23437	.26042	.31250	2.83854
-.5 /	.39063	.36458	.18229	.23437	.31250	.36458	.23437	.26042	.31250	.31250	2.94271
-.4 /	.20833	.29646	.23437	.31250	.28646	.28646	.26042	.20833	.23437	.20833	2.50800
-.3 /	.31250	.33854	.23437	.20833	.23437	.31250	.23437	.33854	.15625	.31250	2.68229
-.2 /	.20833	.18229	.46875	.26042	.23437	.15625	.26042	.23437	.33854	.18229	2.52604
-.1 /	.26042	.39063	.15625	.31250	.26042	.33854	.07812	.20833	.23437	.28646	2.52604
-0.0 /	.13021	.18229	.20833	.28646	.23437	.18229	.36458	.23437	.23437	.52003	2.50800
	.00	.01	.02	.03	.04	.05	.06	.07	.08	.09	TOTAL
0.0 /		.23437	.18229	.28646	.31250	.31250	.13021	.13021	.33854	.23437	2.16146
.1 /	.26042	.26042	.28646	.31250	.20833	.20833	.28646	.26042	.13021	.31250	2.52604
.2 /	.31250	.26042	.26042	.26042	.23437	.23437	.39063	.18229	.23437	.20833	2.57812
.3 /	.23437	.28646	.13021	.26042	.41667	.20833	.18229	.36458	.23437	.18229	2.50800
.4 /	.26042	.33854	.33854	.67812	.15625	.33854	.23437	.31250	.23437	.18229	2.47396
.5 /	.33854	.26042	.44271	.26042	.28646	.26042	.31250	.26042	.18229	.23437	2.83854
.6 /	.33854	.13021	.31250	.44271	.18229	.26042	.20833	.36458	.33854	.18229	2.76842
.7 /	.28646	.26042	.26042	.33854	.28646	.28646	.28646	.39063	.44271	.33854	3.17708
.8 /	.13021	.36458	.20833	.31250	.41667	.33854	.31250	.18229	.23437	.33854	2.83854
.9 /	.46875	.31250	.31250	.28646	.52083	.23437	.33854	.41667	.20833	.41667	3.51562
1.0 /	.26042	.39063	.41667	.44271	.41667	.39063	.36458	.41667	.33854	.44271	3.80021
1.1 /	.52083	.33854	.44271	.52083	.91146	.36458	.41667	.36458	.59896	.39063	4.86979
1.2 /	.49479	.44271	.57292	.44271	.54687	.62500	.59896	.59896	.65104	.62500	5.59896
1.3 /	.75521	1.01562	.91146	1.97917	1.97917	1.14583	.15625	0.00000	0.00000	0.00000	7.94271
1.4 /	0.00000	0.00000	0.00000	0.00000	0.00000	0.00000	0.00000	0.00000	0.00000	0.00000	0.00000

TOTAL DATA POINTS = 3840

V2 FILE 46 TAPE DTJ-2  
 PERCENTAGES OF TIME WITHIN VOLTAGE INTERVALS

INTERVAL MIDPOINTS	.09	.08	.07	.06	.05	.04	.03	.02	.01	.00	TOTAL
-1.4 /	0.00100	0.00000	0.00000	0.00000	.02604	.05208	1.19792	2.31771	1.14503	1.38276	6.04234
-1.3 /	1.07652	.76714	.93899	.73771	.44447	.66596	.59394	.58927	.51107	.43823	6.75591
-1.2 /	.61456	.43091	.37815	.71669	.45356	.35143	.32403	.53033	.27059	.53236	4.68259
-1.1 /	.37747	.32810	.35143	.47824	.43362	.53779	.24455	.27262	.24183	.42752	3.69317
-1.0 /	.43622	.47553	.39808	.21715	.29527	.32606	.50361	.42480	.37679	.24319	3.66672
-.9 /	.18764	.32267	.29595	.34600	.37340	.29527	.29867	.27195	.24251	.21240	2.84587
-.8 /	.29256	.24319	.45356	.29460	.24387	.39741	.26788	.21715	.21783	.52762	3.15565
-.7 /	.18704	.29188	.19179	.34600	.31725	.37272	.13699	.37204	.26516	.18975	2.67363
-.6 /	.29188	.42634	.26991	.21376	.27127	.26449	.16371	.26652	.29324	.32064	2.78225
-.5 /	.19246	.34854	.34329	.29256	.16439	.21783	.16168	.24116	.29460	.34668	2.60267
-.4 /	.23990	.24183	.21376	.21647	.34600	.21579	.18907	.31793	.24048	.31793	2.53906
-.3 /	.11230	.29527	.31860	.18772	.16235	.24251	.24048	.19111	.18636	.29460	2.23131
-.2 /	.29183	.23912	.32471	.21512	.26652	.26449	.13699	.26652	.26923	.21308	2.48766
-.1 /	.26721	.24455	.27844	.16439	.16303	.26923	.26245	.26584	.29256	.18975	2.35745
-0.0 /	.11756	.31725	.23980	.26584	.18840	.31725	.21783	.26652	.13631	.56844	2.61719

	.00	.01	.02	.03	.04	.05	.06	.07	.08	.09	TOTAL
0.0 /		.18840	.29121	.34600	.26855	.21647	.18568	.21172	.21715	.16235	2.08754
.1 /	.39741	.08491	.26788	.32064	.23980	.26584	.21579	.11095	.34193	.21647	2.46162
.2 /	.32064	.13699	.16303	.29324	.29256	.21444	.34871	.23912	.31860	.18772	2.51506
.3 /	.24048	.24183	.23777	.16303	.42752	.18772	.44746	.26991	.26652	.05683	2.53906
.4 /	.34532	.19111	.26923	.36662	.18636	.39944	.24048	.21647	.29256	.26516	2.77276
.5 /	.32132	.16303	.27195	.55366	.16371	.21512	.29460	.16303	.34329	.31860	2.88830
.6 /	.26923	.39402	.24251	.24594	.26516	.34532	.16168	.32199	.32132	.29121	2.85834
.7 /	.13767	.42345	.26721	.34736	.42413	.31996	.16371	.32267	.35007	.26923	3.02544
.8 /	.21172	.32199	.34397	.29460	.34939	.34736	.39876	.31725	.26652	.34736	3.19852
.9 /	.37679	.32064	.32064	.29392	.35211	.34465	.29527	.45356	.39605	.37543	3.52905
1.0 /	.31928	.53101	.50564	.45424	.24523	.40080	.40012	.59773	.50361	.42820	4.34584
1.1 /	.53441	.58173	.50632	.61252	.46644	.60845	.47960	.50429	.79685	.68121	5.75182
1.2 /	.74235	.84486	.87429	.71465	1.21216	1.08398	.92706	1.31768	1.63154	1.69690	11.00518
1.3 /	1.39988	.75562	.20603	.20779	.05154	.02984	.00407	0.00000	0.00000	0.00000	2.65476
1.4 /	0.00000	0.00000	0.00000	0.00000	0.00000	0.00000	0.00000	0.00000	0.00000	0.00000	0.00000

TOTAL DATA POINTS = 3840

V1 FILE 47 TAPE DTT-2  
 PERCENTAGES OF TIME WITHIN VOLTAGE INTERVALS

INTERVAL  
 MIDPOINTS

	.09	.08	.07	.06	.05	.04	.03	.02	.01	.00	TOTAL
-1.4 /	0.00000	0.00000	0.00000	0.00000	0.00000	0.00000	0.00000	0.00000	0.00000	0.00000	0.00000
-1.3 /	0.00000	0.00000	0.00000	.10417	.76312	2.26562	1.22396	1.17188	1.30208	.78125	7.55208
-1.2 /	.59996	.70312	.62500	.62500	.57292	.44271	.57292	.65104	.28646	.41667	5.49479
-1.1 /	.41667	.23437	.49479	.31250	.54687	.23437	.31250	.44271	.46875	.46875	3.93229
-1.0 /	.26042	.33854	.36458	.26042	.46875	.23437	.39063	.39063	.26042	.33854	3.38729
-.9 /	.26042	.28646	.31250	.59896	.52083	.33854	.33854	.52083	.36458	.59896	4.14862
-.8 /	.33854	.28646	.15625	.36458	.39063	.33854	.46875	.36458	.39063	.39063	3.48958
-.7 /	.26042	.20833	.44271	.33854	.31250	.20833	.46875	.33854	.20833	.28646	3.07292
-.6 /	.23437	.36458	.31250	.20833	.36458	.41667	.31250	.41667	.26842	.37812	2.96675
-.5 /	.31250	.26042	.20833	.20833	.26042	.33854	.28646	.39063	.20833	.41667	2.89162
-.4 /	.20833	.20833	.15625	.26042	.31250	.18229	.31250	.20833	.20833	.26042	2.31771
-.3 /	.41667	.13021	.28646	.52083	.18229	.36458	.31250	.26042	.15625	.54687	3.17708
-.2 /	.18229	.15625	.15625	.28646	.39063	.44271	.28646	.23437	.18229	.39063	2.70033
-.1 /	.33854	.18229	.23437	.23437	.28646	.31250	.33854	.15625	.13021	.20833	2.42187
-0.0 /	.13021	.31250	.31250	.20833	.41667	.23437	.20833	.28646	.20833	.46875	2.78646
.....											
	.00	.01	.02	.03	.04	.05	.06	.07	.08	.09	TOTAL
0.0 /		.33854	.26042	.39063	.13021	.31250	.36458	.18229	.33854	.39063	2.70033
.1 /	.18229	.26042	.26042	.10417	.36458	.36458	.23437	.15625	.46875	.07812	2.47396
.2 /	.33854	.31250	.28646	.20833	.28646	.23437	.26042	.28646	.26042	.18229	2.65625
.3 /	.28646	.23437	.39063	.18229	.20833	.41667	.20833	.23437	.31250	.26042	2.73437
.4 /	.33854	.39063	.39063	.10417	.18229	.28646	.28646	.23437	.44271	.36458	3.02083
.5 /	.33854	.39063	.23437	.20833	.20833	.26042	.33854	.39063	.33854	.28646	2.99479
.6 /	.33854	.33854	.20833	.28646	.28646	.36458	.28646	.36458	.41667	.23437	3.12500
.7 /	.36458	.15625	.31250	.44271	.31250	.31250	.18229	.49479	.36458	.31250	3.25521
.8 /	.28646	.36458	.31250	.28646	.39063	.28646	.54687	.39063	.41667	.28646	3.56771
.9 /	.52083	.39063	.44271	.18229	.33854	.28646	.28646	.44271	.41667	.28646	3.59375
1.0 /	.52043	.23437	.39063	.26042	.39063	.23437	.49479	.36458	.33854	.33854	3.56771
1.1 /	.39063	.33854	.46875	.26042	.41667	.75521	.44271	.26042	.46875	.31250	4.11458
1.2 /	.70312	.54687	.65104	.52083	.75521	.85937	.93750	.75521	.83333	1.32812	7.89062
1.3 /	1.97917	1.66667	.39063	0.00000	0.00000	0.00000	0.00000	0.00000	0.00000	0.00000	4.03646
1.4 /	0.00000	0.00000	0.00000	0.00000	0.00000	0.00000	0.00000	0.00000	0.00000	0.00000	0.00000

TOTAL DATA POINTS = 3840

V2 FILE 47 TAPE OTT-2  
 PERCENTAGES OF TIME WITHIN VOLTAGE INTERVALS

INTERVAL MIDPOINTS	.09	.08	.07	.06	.05	.04	.03	.02	.01	.00	TOTAL
-1.4 /	0.00000	0.00000	0.00000	0.00000	0.00000	0.00000	.46875	1.48625	2.18750	1.56250	9.62500
-1.3 /	1.14583	.75521	.65104	.62771	.87769	.73608	.63083	.49927	.47662	.56722	6.96750
-1.2 /	.61456	.56519	.61523	.48503	.40554	.40215	.45763	.56383	.50225	.29731	4.90672
-1.1 /	.42752	.37069	.42955	.29460	.43491	.31860	.21647	.35007	.55908	.27262	3.67811
-1.0 /	.26720	.34736	.34804	.37137	.42887	.16235	.34871	.37476	.16303	.45152	3.26321
-.9 /	.29324	.34600	.32064	.27601	.16981	.34736	.39944	.22190	.26991	.40622	3.05054
-.8 /	.21715	.29392	.26449	.24387	.46080	.26923	.22054	.24387	.24455	.40888	2.79921
-.7 /	.18907	.39605	.24590	.24319	.32064	.23900	.24658	.21715	.18772	.18975	2.47586
-.6 /	.26652	.19179	.24251	.52626	.29595	.14106	.26855	.27127	.29324	.31453	2.81169
-.5 /	.21647	.18907	.26584	.26584	.13699	.21715	.47621	.19246	.21376	.27127	2.44537
-.4 /	.26584	.26584	.26449	.24116	.13835	.26516	.16439	.21576	.37001	.26720	2.45619
-.3 /	.29731	.21172	.24183	.27398	.26516	.21783	.11230	.24116	.29053	.17049	2.32232
-.2 /	.13495	.31657	.29053	.26788	.24455	.16778	.13767	.21444	.31725	.21851	2.31811
-.1 /	.21715	.13496	.34465	.21444	.18975	.26855	.26923	.16332	.28985	.21376	2.30265
0.0 /	.23777	.08626	.24251	.29188	.11532	.29256	.34397	.18975	.37001	.37679	2.54652
.....											
	.00	.01	.02	.03	.04	.05	.06	.07	.08	.09	TOTAL
0.0 /		.16507	.29324	.14038	.21172	.19043	.34804	.23912	.21715	.21851	2.02365
.1 /	.29121	.13699	.39741	.21105	.19179	.37408	.16235	.18636	.24658	.23641	2.43422
.2 /	.26923	.26855	.13767	.23900	.37204	.29256	.29324	.13767	.31928	.34329	2.67334
.3 /	.13767	.18840	.29663	.16100	.34397	.37543	.21376	.37369	.13835	.31928	2.54517
.4 /	.42548	.08830	.29663	.21105	.44746	.24183	.26788	.31860	.32433	.37408	2.99533
.5 /	.19111	.29663	.42277	.18772	.23988	.47553	.26923	.32267	.34736	.26788	3.02030
.6 /	.34736	.26923	.34397	.26788	.13767	.45220	.31996	.37408	.34939	.26652	3.12026
.7 /	.32199	.26449	.32064	.29799	.37272	.26855	.44746	.42955	.32199	.39876	3.44415
.8 /	.21579	.32199	.26855	.34600	.47892	.29392	.37882	.45288	.63585	.26788	3.66862
.9 /	.24794	.34871	.50632	.31725	.55569	.52829	.31996	.37611	.45356	.39888	4.05192
1.0 /	.50836	.52694	.40680	.63178	.42684	.65715	.37747	.71262	.47757	.73288	9.45749
1.1 /	.58309	.39944	.79346	1.07449	.68793	1.03529	1.10528	1.10353	.87158	1.07585	8.72694
1.2 /	1.50269	1.81112	1.79779	1.52398	1.00925	.51717	.12858	.04571	.02170	.03459	8.38257
1.3 /	.05154	.04340	.31017	0.00000	0.00000	0.00000	0.00000	0.00000	0.00000	0.00000	.10512
1.4 /	0.00000	0.00000	0.00000	0.00000	0.00000	0.00000	0.00000	0.00000	0.00000	0.00000	0.00000

TOTAL DATA POINTS = 3840

V1 FILE 48 TAPE DTT-2  
PERCENTAGES OF TIME WITHIN VOLTAGE INTERVALS

INTERVAL MIDPOINTS	.09	.08	.07	.06	.05	.04	.03	.02	.01	.00	TOTAL
-1.4 /	0.00000	0.00000	0.00000	0.00000	0.00000	0.00000	0.00000	0.00000	0.00000	0.00000	0.00000
-1.3 /	0.00000	0.00000	0.00000	0.00000	0.00000	0.00000	.07812	.49479	1.40625	1.53646	3.51562
-1.2 /	1.38021	1.11979	.72917	.85937	.80729	.70312	.72917	.57292	.36458	.65104	7.91667
-1.1 /	.41667	.52083	.39063	.46875	.52083	.26042	.46875	.52083	.52083	.28646	4.37500
-1.0 /	.33854	.41667	.39063	.23437	.46875	.39063	.39063	.31250	.70312	.18229	3.82812
-.9 /	.23437	.44271	.18229	.54687	.39063	.18229	.15625	.46875	.39063	.15625	3.15104
-.8 /	.20833	.31250	.26042	.46875	.20833	.28646	.44271	.28646	.20833	.33854	3.02083
-.7 /	.23437	.26042	.26042	.26042	.33854	.39063	.41667	.23437	.23437	.26042	2.89062
-.6 /	.44271	.49479	.15625	.44271	.28646	.31250	.31250	.33854	.28646	.13021	3.20312
-.5 /	.49479	.39063	.46875	.20833	.23437	.31250	.33854	.26042	.20833	.46875	3.38542
-.4 /	.33854	.39063	.33854	.26042	.33854	.36458	.18229	.41667	.26646	.36458	3.28125
-.3 /	.23437	.23437	.41667	.28646	.15625	.20833	.44271	.23437	.28646	.23437	2.73437
-.2 /	.31250	.39063	.33854	.31250	.44271	.18229	.23437	.36458	.39063	.28646	3.25521
-.1 /	.36458	.31250	.23437	.28646	.26042	.20833	.33854	.20833	.33854	.36458	2.91667
0.0 /	.44271	.15625	.46875	.26042	.23437	.46875	.23437	.18229	.41667	.62500	3.48958
0.0 /	.00	.01	.02	.03	.04	.05	.06	.07	.08	.09	TOTAL
0.0 /		.26042	.36458	.31250	.31250	.39063	.23437	.23437	.23437	.18229	2.52604
.1 /	.33854	.26042	.33854	.28646	.31250	.39063	.28646	.44271	.10417	.31250	3.07292
.2 /	.36458	.41667	.31250	.23437	.33854	.36458	.33854	.26042	.26042	.36458	3.25521
.3 /	.23437	.26042	.33854	.31250	.36458	.33854	.39063	.28646	.15625	.44271	3.12500
.4 /	.28646	.31250	.33854	.28646	.44271	.28646	.39063	.20833	.20833	.39063	3.15104
.5 /	.36458	.36458	.36458	.23437	.26042	.41667	.39063	.28646	.33854	.33854	3.35937
.6 /	.31250	.20833	.39063	.31250	.44271	.36458	.20833	.46875	.39063	.52083	3.61979
.7 /	.41667	.44271	.23437	.31250	.26042	.36458	.23437	.20833	.18229	.23437	2.89062
.8 /	.26042	.44271	.20833	.39063	.18229	.31250	.36458	.36458	.18229	.33854	3.04687
.9 /	.28646	.20833	.36458	.13021	.31250	.36458	.33854	.46875	.36458	.46875	3.30729
1.0 /	.26042	.33854	.20833	.46875	.33854	.31250	.41667	.39063	.33854	.46875	3.54167
1.1 /	.46875	.44271	.49479	.52083	.39063	.46875	.52083	.54687	.31250	.59896	4.76562
1.2 /	.70312	.59896	.65104	.62500	.93750	1.09375	1.45833	1.95313	1.01562	.28646	9.32292
1.3 /	.05208	0.00000	0.00000	0.00000	0.00000	0.00000	0.00000	0.00000	0.00000	0.00000	.05208
1.4 /	0.00000	0.00000	0.00000	0.00000	0.00000	0.00000	0.00000	0.00000	0.00000	0.00000	0.00000

TOTAL DATA POINTS = 3840



V2 FILE 48 TAPE DTT-2  
 PERCENTAGES OF TIME WITHIN VOLTAGE INTERVALS

INTERVAL MIDPOINTS	.09	.08	.07	.06	.05	.04	.03	.02	.01	.00	TOTAL
-1.4 /	0.0000	0.0000	0.0000	0.0000	0.0000	0.0000	0.0000	0.0000	0.0000	0.0000	0.0000
-1.3 /	1.1979	91146	67700	62503	78125	52003	75724	48164	2.23950	1.61450	4.66146
-1.2 /	45261	62812	51378	62134	43769	40706	43566	48159	66162	63897	7.17489
-1.1 /	42752	48231	21851	37679	53440	34532	27262	14377	60419	82413	5.82884
-1.0 /	39944	42752	29663	26652	19450	32267	27059	34668	33081	21300	3.68044
-0.9 /	39673	44215	31725	30071	19246	36933	42074	32471	21851	18636	3.82893
-0.8 /	26584	29460	29324	37679	50222	18975	08965	29352	21376	26923	3.78700
-0.7 /	37069	34532	24116	28319	24116	40080	27127	26652	21444	31928	2.91302
-0.6 /	27195	19518	31657	27195	16371	40251	24251	34736	34600	28985	2.68750
-0.5 /	27330	24455	19450	26584	37069	29460	19111	21512	18772	22054	2.57755
-0.4 /	32132	24455	26923	18917	29527	26991	29121	11502	24183	19179	2.82920
-0.3 /	34465	26652	21918	21979	23044	23980	19382	26652	29392	18840	2.46704
-0.2 /	24251	19246	50361	19043	11570	18704	24048	21783	32267	16371	2.37644
-0.1 /	24387	26855	31860	34600	16313	23980	34736	21376	21715	19179	2.56991
-0.0 /	32493	23844	16846	29324	26652	32471	31660	16100	54939	40690	2.85129
0.0 /	0.0000	0.0000	0.0000	0.0000	0.0000	0.0000	0.0000	0.0000	0.0000	0.0000	0.0000
0.1 /	26923	26720	21783	28251	34660	19246	18840	13631	37069	18704	2.84912
0.2 /	32199	24523	19111	29392	32064	14038	26788	35307	28917	13835	2.52794
0.3 /	37469	29324	32132	21647	29527	34804	26923	24116	24116	16574	2.61081
0.4 /	42413	21647	19111	18975	16574	26923	29663	31996	21844	80215	2.80348
0.5 /	34804	29595	42616	18975	14174	31996	21851	37001	34397	34871	2.76435
0.6 /	42480	18772	32267	11027	44949	34939	24455	18975	19111	26923	2.87384
0.7 /	47960	32403	18840	34668	42820	26991	34397	22054	50496	27398	3.32343
0.8 /	37137	45424	34397	29663	47553	29595	24048	42209	49954	34465	3.59050
0.9 /	42413	52330	58429	46610	39876	58105	50429	21793	39537	39944	3.88143
1.0 /	44949	52965	68251	79346	59569	71126	68590	61117	50429	63721	5.26842
1.1 /	50700	1.05320	1.15872	1.23752	1.59871	1.67887	2.22711	1.83716	1.31022	1.872	13.32723
1.2 /	26060	1.1560	0.1695	0.1628	0.2441	0.2448	0.3798	0.0586	0.02645	0.0746	0.2530
1.3 /	0.0136	0.0300	0.0000	0.0000	0.0000	0.0000	0.0000	0.0000	0.0000	0.0000	0.0000
1.4 /	0.0000	0.0000	0.0000	0.0000	0.0000	0.0000	0.0000	0.0000	0.0000	0.0000	0.0000

TOTAL DATA POINTS = 3840

## INITIAL DISTRIBUTION

Copies		Copies	Code
1	Commandant of Marine Corps Library		
1	DNL	1	01
1	NRL	1	011
1	NUSNA	1	012
1	USNA	1	15
1	USN PGSCOL	1	1524
1	USN ROTC AND NAVADMIN, MIT		J. Gordon
1	Naval War College	1	16
1	Naval War College	1	17
1	NAVELECSYSCOM Library	1	18
1	NAVELECSYSCOM Library	1	1842
7	NAVSHIPSYSYSCOM		R. Johnson
1	SHIPS 09C	1	19
3	SHIPS 205	1	27
1	SHIPS 2052 Library	1	28
2	SHIPS 03	1	28
1	NAVAIRSYSYSCOM Library	1	29
1	NAVAIRSYSYSCOM Library		F. Kendall
1	Naval Observatory Library	5	296
1	Naval Observatory Library	1	56
1	NADC	1	93
1	NELC		
1	NUC		
1	NWC		
1	NCEL		
1	NCSL		
1	NOL		
1	NWL		
1	NUSC		
1	NAVOCEANO		
12	DDC		

UNCLASSIFIED

Security Classification

DOCUMENT CONTROL DATA - R & D		
<i>(Security classification of title, body of abstract and indexing annotation must be entered when the overall report is classified)</i>		
1. ORIGINATING ACTIVITY (Corporate author) Naval Ship Research and Development Center Bethesda, Maryland 20034		2a. REPORT SECURITY CLASSIFICATION <b>UNCLASSIFIED</b>
		2b. GROUP
3. REPORT TITLE <b>LOW COST, HIGH ACCURACY INSTRUMENTATION TAPE RECORDER</b>		
4. DESCRIPTIVE NOTES (Type of report and inclusive dates) <b>Final Report</b>		
5. AUTHOR(S) (First name, middle initial, last name) <b>Robert G. Stilwell</b>		
6. REPORT DATE <b>December 1972</b>	7a. TOTAL NO. OF PAGES <b>116</b>	7b. NO. OF REFS <b>2</b>
8a. CONTRACT OR GRANT NO.	9a. ORIGINATOR'S REPORT NUMBER(S) <b>Report 3875</b>	
b. PROJECT NO. <b>FXX 412</b>		
c. <b>Task No. ZFXX 412001</b>	9b. OTHER REPORT NO(S) (Any other numbers that may be assigned this report) <b>AD757 011</b>	
d. <b>Work Unit No. 632-016</b>		
10. DISTRIBUTION STATEMENT <b>Approved for public release: distribution unlimited.</b>		
11. SUPPLEMENTARY NOTES	12. SPONSORING MILITARY ACTIVITY <b>Naval Ship Research &amp; Development Center Bethesda, Maryland 20034</b>	
13. ABSTRACT <p>This report describes a new magnetic tape recording system for general instrumentation use. The system uses a new type of modulation format and offers excellent performance at low cost. The system concepts are explored from a subsystem or "block diagram" viewpoint, and extensions of these concepts are hypothesized. An actual prototype is described, its specifications and performance parameters given, and the results of its evaluation program presented. The history of the system from 1967 to 1971 is also included for completeness. The differential pulse width modulation (DPWM) concept is considered to represent a truly significant advance in modulation techniques.</p>		

UNCLASSIFIED

Security Classification

14. KEY WORDS	LINK A		LINK B		LINK C	
	ROLE	WT	ROLE	WT	ROLE	WT
Magnetic tape recorder Digital magnetic tape recorder Low-cost tape recorder Portable tape recorder Computer studies Tape recorder Instrumentation tape recorder						



1

2

