

MIT LIBRARIES



3 9080 02486 5641

















Digitized by the Internet Archive  
in 2011 with funding from  
MIT Libraries









621.3051

MASS. INSTITUTE  
OF  
TECHNOLOGY  
FEB 28 1891  
LIBRARY.

# The Street Railway Gazette.

FIFTH VOLUME

*January to December, 1890.*

THE GAZETTE COMPANY.

CHICAGO.

CHICAGO



TF.  
E-8  
V. 5  
1970

Humanities  
MASS. INST. TECH.  
AUG 26 1974  
LIBRARIES

# INDEX TO LEADING ARTICLES, ETC.

<p>Abolition of duty on copper ..... 37</p> <p>Acknowledgments ..... 50, 205</p> <p>A fraudulent advertising scheme ..... 163</p> <p>A great work finished ..... 152</p> <p>All copper rail bond ..... 133</p> <p>American Institute Electrical Engineers ..... 89</p> <p>American Street Railway Association ..... 70</p> <p>Among the exhibitors ..... 51, 52</p> <p>An electric railway association ..... 162</p> <p>An electric street railway motor, by John W. McNameara ..... 168</p> <p>Another victory for the overhead system ..... 24</p> <p>Announcements ..... 62, 162, 163</p> <p>Annual convention ..... 181, 189, 191, 203</p> <p>Another Richmond in the field ..... 57, 223</p> <p>A scenic road operated ..... 133</p> <p>Associations, officers of, etc. .... 23, 97, 117, 172</p> <p>Atkinson overhead switch ..... 22</p> <p>Automatic Alarm for cable railways ..... 184</p> <p>Automatic high speed engine ..... 56</p> <p>ANNUAL MEETINGS (official reports)</p> <p>  A. S. R. A. .... 181-189, 191-203</p> <p>  Association of Edison Illuminating Companies 174</p> <p>  N. E. L. A. (Cape May Convention) ..... 153-166</p> <p>  N. E. L. A. (Kansas City Convention) ..... 36-47</p> <p>  New York Street Railway Association (Rochester Convention) ..... 168-172</p> <p>  Ohio State Tramway Association ..... 205-207, 218-223</p> <p>  West End Street Railway Co., Boston ..... 235-236</p> <p>Banquet to retiring officers ..... 19</p> <p>Belleville Cable Road, Paris ..... 215</p> <p>Bewitching attractiveness ..... 114</p> <p>BIOGRAPHICAL:</p> <p>  Robinson, J. C. .... 1</p> <p>  Watson Henry M. .... 181</p> <p>Bond offerings ..... 16, 31, 51</p> <p>Book reviews ..... 15, 144, 174</p> <p>Brennan Wire Connector ..... 208</p> <p>Brush Co. (Storage Battery decision) ..... 61</p> <p>Business notes ..... 15, 30, 71, 72, xix, 104, 124</p> <p>Cable railways, their defects and remedies ..... 82, 97, 111, 112, 133, 134, 135</p> <p>Cabling 3d avenue ..... 114</p> <p>Cantilever motor truck ..... 19</p> <p>Cape May convention ..... 134, 153-166</p> <p>Carettes in Chicago ..... 113</p> <p>Car heating ..... 74, 75, 211</p> <p>Cars for electric traction work ..... 141</p> <p>Car starter and brake ..... 57</p> <p>Caught at Cape May ..... 166</p> <p>Centre curve insulator ..... 7</p> <p>Census and electricity ..... 134</p> <p>Chancellor Gibson's Knoxville decision ..... 78, 79</p> <p>City and South London electric railway ..... 212</p> <p>Coincidence "A Remarkable" ..... 134, 135</p> <p>Combined heater and filter ..... 208</p> <p>Compound engine for electric service ..... 60</p> <p>Compound high speed engine ..... 53</p> <p>Conduits, interior ..... 130, 131, 151</p> <p>Constitution, new (N. E. L. A.) ..... 165</p> <p>Conduit system, Harding's ..... 210</p> <p>Conduits, underground, by Fred Degenhardt ..... 209</p> <p>Consolidation of parallel lines ..... 216</p> <p>Construction of central stations, by C. J. H. Woodbury ..... 93, 94</p> <p>Convention exhibits ..... 51, 52, 166, 167, 201</p> <p>Convention notes ..... 223</p> <p>Copper tariff ..... 155</p> <p>Curious accident to a cable car ..... 30</p> <p>Curve insulator, new ..... 149</p> <p>Czar horse shoe cushion ..... 152</p> <p>Decision by Judge Bundy, in interference suit ..... 23</p> <p>Decision, Judge Langdon's ..... 115</p> <p>Decisions, Legal (courts last appeal) see following pages</p> <p>Decision, the Brush ..... 62</p> <p>Decision, State railway commissioners' ..... 137</p> <p>Does current between wheel and rail increase traction, by C. T. Crosby ..... 76, 77</p> <p>Double fusible safety box ..... 150</p> <p>Double motor truck ..... 60</p> <p>Duquesne traction wins ..... 136, 137</p> <p>Edco storage battery car, by D. H. Bates ..... 193</p> <p>Edison system, by E. E. Higgins ..... 195</p> <p>Effect of the McKinley bill upon the street railway industry ..... 238</p> <p>Elections ..... 12, 28, 29, 30, 49, 69, 84, 103, 103, 123, 139, 140, 178, 206, 243</p> <p>Electric car heating ..... 211</p> <p>Electric cars in a snow storm ..... 55</p> <p>Electric current as a traction increaser, by E. E. Ries ..... 106</p> <p>Electric headlight ..... 4</p> <p>Electric hoist for car houses ..... 21</p> <p>Electricity supplants steam ..... 94</p> <p>Electric locomotives for mining tramways ..... 3</p> <p>"Electric motive power technically considered," by Dr. W. L. Allen ..... 187, 188, 189</p> <p>Electric motors in general railway work, by Dr. Louis Bell ..... 94, 107-8-9</p> <p>Electric motors vs. steam locomotives, by John C. Henry ..... 110</p> <p>Electric railways as investments ..... 42</p> <p>Electric railway census ..... 131-2</p> <p>Electric Railway Association ..... 24, 160</p> <p>Electric railway at Pittsburg, Kan. .... 95</p> <p>Electric railway power house ..... 105</p> <p>Electric Railways, by Theo. P. Bailey ..... 213</p> <p>Electric railways (discussion) ..... 232-3-4-5</p> <p>Electric railways in North America, list of ..... 16, 31, 51, 88, 104, xxii, 116, 143, 130, 204, 228, 248</p> <p>Electric railways (River and Rail system) ..... 145-6-7</p> <p>Electric railway specialties ..... 113</p> <p>Electric snow plow ..... 34</p> <p>Electric stationary motor for railway circuits ..... 35</p> <p>Expiring patents ..... 14, 87, 103, 123, 142, 179</p> <p>Extensions 12, 30, 50, 70, 84, 102, 123, 140, 178, 226, 243</p>	<p>Feed water heater and purifier ..... 93</p> <p>Findlay (O.) street railway ..... 60</p> <p>Fishkill-Corliss engine ..... 125-6-7</p> <p>Foreign tramways, news from ..... 12, 13, 14, 77, 78, 85, 86, 87, 140, 141</p> <p>"For this occasion only" ..... 153</p> <p>Friction clutch device for constant speed motors ..... 112</p> <p>From the Argentine ..... 77-8, 241</p> <p>"Gazette's Special," the ..... 222</p> <p>Gearing with wooden teeth for electric railways ..... 129, 130</p> <p>Generator, Rac's ..... 78-9</p> <p>Grinding mill, the scientific ..... 7</p> <p>Harmonizing insurance and electric light interests ..... 157</p> <p>"Hit him, he has no friends" ..... 135-6</p> <p>Ho, for Niagara ..... 200</p> <p>Horse releasing device ..... 95</p> <p>"How our paths may be paths of peace" ..... 39</p> <p>ILLUSTRATED ARTICLES—</p> <p>  An all copper rail bond ..... 133</p> <p>  Atkinson overhead switch ..... 22</p> <p>  Automatic alarm for cable railways ..... 184</p> <p>  Automatic engine (Rice's) ..... 5</p> <p>  Automatic high speed engine ..... 56</p> <p>  Belleville cable road, Paris, France ..... 215</p> <p>  Brake lever, ratchet ..... 151</p> <p>  Brennan wire connector ..... 208</p> <p>  Cantilever motor truck ..... 19</p> <p>  Car heating ..... 74, 75</p> <p>  Car starter and brake ..... 57</p> <p>  Carettes in Chicago ..... 113</p> <p>  Centre curve insulator ..... 7</p> <p>  City and South London electric railway ..... 212-231</p> <p>  Combined heater and filter ..... 208</p> <p>  Compound engine for electric service ..... 60</p> <p>  Compound high speed engine ..... 53</p> <p>  Conduits, interior ..... 130, 131</p> <p>  Conduit system, Harding's ..... 210</p> <p>  Conduits, underground ..... 209</p> <p>  Czar horse shoe cushion ..... 152</p> <p>  Double fusible safety box ..... 150</p> <p>  Double motor truck ..... 60</p> <p>  Eighty horse power generator ..... 73</p> <p>  Electric cars in a snowstorm ..... 55</p> <p>  Electric car heating ..... 211</p> <p>  Electric headlight ..... 4</p> <p>  Electric hoist for car houses ..... 21</p> <p>  Electric lighting, Sperry system ..... 129</p> <p>  Electricity supplants steam (Dallas, Tex.) ..... 94</p> <p>  Electric locomotives for mining tramways ..... 3</p> <p>  Electric railway in Pittsburgh ..... 148-149</p> <p>  Electric railway power house ..... 105</p> <p>  Electric Railways (River and Rail system) ..... 145, 146, 147</p> <p>  Electric railway specialties ..... 113</p> <p>  Electric snow plow ..... 34</p> <p>  Electric stationary motor for railway circuits ..... 35</p> <p>  Electric traction, by E. P. Roberts ..... 6</p> <p>  Electric truck, Tripp's ..... 184</p> <p>  Feed water heater and purifier ..... 93</p> <p>  Felt, fire ..... 152</p> <p>  Fishkill-Corliss engine ..... 125, 126, 127</p> <p>  Friction clutch, device for constant speed motors ..... 112</p> <p>  Gearing with wooden teeth for electric railways ..... 129, 130</p> <p>  Generator, Rac's ..... 78, 79</p> <p>  Hoist, electric ..... 20</p> <p>  Horse shoe cushion ..... 152</p> <p>  Grinding mill, the scientific ..... 7</p> <p>  Incandescent lamp for electric cars ..... 31</p> <p>  Interior conduits ..... 130, 131</p> <p>  Intermediate speed regulator ..... 208</p> <p>  Lattice-work pole for overhead wires ..... 56</p> <p>  Leather covered pulley ..... 19</p> <p>  London's subterranean electric railway ..... 212, 231</p> <p>  Mill tramway at Lawrence, Mass. .... 57</p> <p>  Motor for electric railway power houses ..... 35</p> <p>  New curve insulator ..... 149</p> <p>  New designs in poles ..... 76</p> <p>  New electric coal cutter ..... 21</p> <p>  New motor-dynamo ..... 89</p> <p>  New pivotal truck ..... 184</p> <p>  New railway truck ..... 185</p> <p>  Neversink Mountain electric railway ..... 54</p> <p>  New style in poles ..... 56</p> <p>  Patent fire felt ..... 152</p> <p>  Patton motor, the ..... 77</p> <p>  Perret low speed electric motors ..... 128, 129</p> <p>  Pingree switch, the ..... 56</p> <p>  Pole ratchet ..... 30</p> <p>  Pole, lattice-work ..... 56</p> <p>  Poles, new designs ..... 76</p> <p>  Pulley, leather covered ..... 19</p> <p>  Rac generator ..... 78, 79</p> <p>  Ratchet brake lever ..... 151</p> <p>  Rice automatic engine ..... 5</p> <p>  Robinson J. C. portrait of, etc ..... 1</p> <p>  Small electric hoist ..... 20</p> <p>  Snow plow ..... 34</p> <p>  South Broadway line, St. Louis ..... 4</p> <p>  Special engine for electric railway work ..... 33</p> <p>  Speed Regulator ..... 208</p> <p>  Sperry system of electric lighting ..... 129</p> <p>  Stationary motor for distributing power ..... 17</p> <p>  Stationary motor for Ry. circuits ..... 35</p> <p>  Stationary motor for power houses ..... 34</p> <p>  Stewart John N. portrait, etc ..... 205</p> <p>  Tramway sprinkler ..... 35</p> <p>  Tripp electric truck ..... 184</p> <p>  Trolley wire insulator ..... 19</p> <p>  Truck, new pivotal ..... 184</p> <p>  Underground conduits, by Fred Degenhardt ..... 209</p> <p>  Water tube steam boiler ..... 150</p> <p>  Watson Col. H. M. portrait, etc ..... 181</p> <p>  Westinghouse compound engine and alternator ..... 17</p> <p>  Westinghouse motors in Greensburg, Pa. .... 185</p> <p>  Incandescent lamp for electric cars ..... 21</p>	<p>Increasing locomotive traction by use of electricity, by C. Seiden ..... 111</p> <p>Insulation, liquid ..... 155</p> <p>Insulator, new curve ..... 149</p> <p>Interest in electricity ..... 152</p> <p>Interior conduits ..... 130, 131, 151, 195</p> <p>Intermediate speed regulator ..... 208</p> <p>Inter-mural transit ..... 30</p> <p>In union there is strength ..... 96</p> <p>"Key streets" ..... 134</p> <p>Kirchner's cable system ..... 22</p> <p>Knight W. B., deceased ..... 238</p> <p>Kryger snow shovel for electric railways ..... 7</p> <p>Large electric traveling crane ..... 113</p> <p>Large mileage ..... 36</p> <p>Lattice work pole for overhead wires ..... 56</p> <p>Leather covered pulley ..... 19</p> <p>Legal decisions—courts of last appeal (see following pages)</p> <p>  Limitation of steam and electricity in transportation—O. T. Crosby ..... 89-92</p> <p>  Liquid insulation ..... 155</p> <p>  Literary notes ..... 124</p> <p>  Low speed electric motors ..... 128, 129, 229</p> <p>  London's subterranean electric railway ..... 212-231</p> <p>  Low speed multipolar dynamos and motors—Frank A. Perret ..... 229</p> <p>  "Makein' of the motor"—C. Emery ..... 78</p> <p>MARRIAGES:</p> <p>  Bowie—Bennett ..... 246</p> <p>  Leonard—Tromanhauser ..... 246</p> <p>  McKinlock—Rappleye ..... 246</p> <p>  Woodbridge—Foster ..... 143</p> <p>McKinley bill ..... 237-8</p> <p>Met on the road ..... 30, xix.</p> <p>Mileage, large ..... 36</p> <p>Mill tramway at Lawrence, Mass. .... 57</p> <p>Missed at the convention ..... 223</p> <p>Modern cable railway ..... 237</p> <p>More cable service ..... 132-3</p> <p>Motor for electric railway power houses ..... 35</p> <p>Motor, stationary, for power houses ..... 34</p> <p>N. E. L. A.—Kansas City convention ..... 20 and 36 to 47</p> <p>  Cape May convention ..... 153, 166</p> <p>  Neversink Mountain electric railway ..... 54</p> <p>  New curve insulator ..... 149</p> <p>  New designs in poles ..... 75</p> <p>  New electric coal cutter ..... 21</p> <p>  New electric railway in the South ..... 53</p> <p>  New enterprises—11, 12, 27, 28, 49, 67, 84, 101, 102, 121, 122, 123, 139, 177, 225, 244</p> <p>  New motor dynamo (Forec Bain's) ..... 89</p> <p>  New pivotal truck (Brill's) ..... 184</p> <p>  New railway truck (Aenebacher's) ..... 185</p> <p>  New Star lamp burner ..... 22</p> <p>  New York State St. Ry. Assn.—Rochester convention ..... 158 to 172</p> <p>  No danger in the trolley wire ..... 8</p> <p>  No time like the present ..... 8</p> <p>  Novel application of an electric motor ..... 34</p> <p>  Novel schemes for the development of street railways, by B. F. Owen ..... 189, 191</p> <p>OBITUARY—W. G. Brownlee, 15; Albert Eames, 15; H. A. Glasier, 72; W. B. Knight, 246; Rufus Martin, 15; H. B. Wilson, 30.</p> <p>Ohio State Tramway Association—Columbus convention ..... 205, 223</p> <p>Okonite ..... 148</p> <p>Parallel lines, consolidation of ..... 215</p> <p>Patent fire felt ..... 152</p> <p>Patents, expired and expiring—14, 87, 103, 123, 142, 179, 246, 247</p> <p>Patents, street railway—14, 87, 103, 123, 142, 179, 246, 247</p> <p>Perfect street railway horse, by Chas. Odell ..... 180</p> <p>Patton motor, the ..... 77</p> <p>Perret low speed electric motor ..... 128, 129, 229</p> <p>Personals ..... 14, xix., 203</p> <p>Pingree switch ..... 56</p> <p>Pivotal truck, new ..... 184</p> <p>Pole, patent ..... 143</p> <p>Pole ratchet ..... 30</p> <p>Poor construction ..... 8</p> <p>Power station, Wilmington (Del.) City Ry. Co. .... 113</p> <p>Practical points in electric car service, by O. T. Crosby ..... 18</p> <p>Pulley, leather covered ..... 19</p> <p>Quick work ..... 7</p> <p>Rac generator ..... 78, 79</p> <p>Railway Commissioners' decision, state ..... 137</p> <p>Ratchet brake lever ..... 151</p> <p>Ratchet, pole ..... 30</p> <p>Recent Edison central stations and results obtained, by C. J. Field ..... 39</p> <p>Regulator, intermediate speed ..... 208</p> <p>Remarkable coincidence ..... 134, 135</p> <p>Reprehensible journalism ..... 8</p> <p>Rhomberg's J. A. big scheme ..... 6</p> <p>Rice automatic engine ..... 5</p> <p>Richmond road controversy ..... 8</p> <p>Richmond road, that ..... 2</p> <p>Roberts E. P. on electric traction ..... 6</p> <p>Rochester railway ..... 73</p> <p>Ruling passion strong in death ..... 152</p> <p>Safety device for overhead conductors ..... 232</p> <p>Sense and logic ..... 114</p> <p>Single and double trolley wire systems, by George W. Mansfield ..... 96-7-8</p> <p>Social side of the electric railway, by T. C. Martin ..... 57</p> <p>South Broadway line, St. Louis ..... 4</p> <p>Souvenirs of Buffalo Convention ..... 223</p> <p>Sperry system of electric lighting ..... 129</p> <p>Sprague motor in the Land of the Dakotas ..... 147</p> <p>Special engine for electric railway work ..... 33</p> <p>Special notices ..... 179</p> <p>Sprague Co., winter business of ..... 34</p>
---	--	--







Taylor v. Brooklyn Elevated Ry. Co. 23 N. E. Rep. 1106. Court of Appeals of New York	120	Third Ave. Railway Co., Mayor, etc., of New York, v. 22 N. E. Rep. 754. Court of Appeals of New York	9	Watson v. St. Paul City Railway Co., 43 N. E. Rep. 904. Sup. Court of Minnesota	9
Tallman v. Metropolitan Elevated Ry. Co., 23 N. E. Rep. 1134. Court of Appeals of New York	98	Trenton Horse Ry. Co., City of Trenton v. 19 At. Rep. 262. Court of Chancery of New Jersey	137	Wilcox, Chicago City Railway Co. v. 24 N. E. Rep. 49. Sup. Court of Illinois	239
Taggart v. Newport Street Railway Co. 19 At. Rep. 326. Sup. Court of Rhode Island	81	Uransby v. Dry Dock E. B. & B. Ry. Co., 23 N. E. 451. Court of Appeals of New York	119	Weil v. Dry Dock E. B. & B. Railway Co., 23 N. E. Rep. 486. Court of Appeals of New York	65
Third Ave. Railway Co. In re. 24 N. E. Rep. 951. Court of Appeals of New York	241	Union Street Railway Co., Howland v. 22 N. E. Rep. 434. Sup. Judicial Court of Massachusetts	9	Winters v. Kansas City Cable Railway Co., 12 S. W. Rep. 652. Sup. Court of Missouri	119
Thomas, Citizens' Passenger Railway Co. v. 19 At. Rep. 286. Sup. Court of Pennsylvania	98	West End Street Railway Co., Magee v. 23 N. E. Rep. 1102. Sup. Judicial Court of Massachusetts	117	Williams v. City Electric Street Railway Co., 41 Fed. Rep. 556. Circuit Court of the United States, Eastern District of Kansas	118
Trenton Horse Railway Co., Breese v. 19 At. Rep. 204. Sup. Court of New Jersey	80				

TABLE OF CASES CITED.

Astor v. Railroad Co., 113 N. Y. 93; 20 N. E. Rep., 594. In Re Third Ave. Ry. Co.	10	Kunze v. City of Troy, 104 N. Y. 344; 10 N. E. Rep., 442. Weil v. Drydock E. B. & B. Ry. Co.	65	Railroad Co., Green v. 12 Abb. N. C. 124; Tallman v. Metropolitan Elevated Ry. Co.	98
Bovee v. Danville, 53 Vt. 190; Augusta & S. Ry. Co. v. Randall	217	Klingler v. Bickel, 117 Pa. St. 326; 11 At. Rep., 555. Appeal of Easton S. E. & W. P. Ry. Co.	117	Railroad Co., Gumb v. 114 N. Y. 411; 21 N. E. Rep., 993. Uransby v. Dry Dock E. B. & B. Ry. Co.	119
Bingham Railroad Co. v. 87 Tenn. 522; 11 South W. Rep., 705. East End St. Ry. Co. v. Doyle	9	Kerr, People v. 27 N. Y. 201; Williams v. Electric St. Ry. Co.	118	Railroad Co., Darwin v., 23 S. C. 531. Donahue v. Enterprise Ry. Co.	118
Buck Railroad Co. v. 95 Ind. 346; Richmond City Ry. Co. v. Scott	8	Kane, Railroad Co. v. 69 Md. 23; 13 At. Rep., 387. Baltimore & Y. Turnpike Road v. Cason	4	Railroad Co., Dorlan v., 46 Pa. St. 520. Tallman v. Metropolitan Elevated Ry. Co.	98
Barrett v. Railroad Co., 45 N. Y. 628; Richmond City Ry. Co. v. Scott	8	Kelly Lehman v. 68 Ala. 129; Birmingham Union Ry. Co. v. Hale	217	Robinson v. Cone, 22 Vermont 213. Winters v. Kansas City Cable Ry. Co.	119
Briggs v. Railroad Co., 79 Me. 363; 10 At. Rep., 47. Williams v. City Electric St. Ry. Co.	118	Lissner U. S., v. 12 Fed. Rep., 840; Morgan v. Jersey City & Bergen Ry. Co.	25	Railroad Co., Carter v., 19 S. C. 20. Donahue v. Enterprise Ry. Co.	118
Boland v. Railroad Co., 36 Mo. 485; Winters v. Kansas City Cable Ry. Co.	119	Lee v. Railroad Co., 13 Barb. 169. In re. Utica R. Co., 56 Barb. 456. In re. Prospect Park & C. I. R. Co., 13 Hun. 345. In re. New York C. & H. R. R. Co., 15 Hun. 63. In re. New York L. & W. R. Co., 29 Hun. 1. Id. 2 N. Y. Supp. 478. Newman v. Metropolitan Elevated Ry. Co.	120	Railroad Co., Cronch v., 21 S. C. 495. Donahue v. Enterprise Ry. Co.	118
Birkett v. Ice Co. 110 N. Y. 506; 18 N. E. Rep., 108. Weil v. Drydock, E. B. & B. Ry. Co.	65	Lawless v. Railroad Co., 136 Mass. 1, 5; Magee v. West End St. Ry. Co.	117	Railroad Co., Briggs v., 79 Me. 363; 10 At. Rep., 47. Williams v. City Electric St. Ry. Co.	118
Brown Slack v. 13 Wend. 390; Taylor v. Brooklyn Elevated Ry. Co.	120	Lehman v. Kelly, 68 Ala. 129; Birmingham Union Ry. Co. v. Hale	217	Railroad Co., Boland v., 36 Mo. 485; Winters v. Kansas City Cable Ry. Co.	119
Bickel Klingler, v. 117 Pa. St. 326; 11 At. Rep., 555; Appeal of Easton S. E. & W. E. P. Ry. Co.	117	Mayor, e'c, Elhrgott, v. 96 N. Y. 275; Uransby v. Dry Dock E. B. & B. Ry. Co.	119	Railroad Co., Barrett v., 45 N. Y. 628. Richmond City Ry. Co. v. Scott	8
Bernheimer, Traction Co., v. 125 Pa. St. 615; 17 At. Rep., 477. Steiner v. Philadelphia Traction Co.	118	Miles, Railroad Co. v. 6 South Rep., 696; North Birmingham St. Ry. Co. v. Calderwood	98	Railroad Co. v. Buck, 96 Ind. 346. Richmond City Ry. Co. v. Scott	8
Bernheimer, Traction Co., v. 17 At. Rep., 477; Citizens' Passenger Ry. Co. v. Thomas	98	Mitchell v. Railway Co., 51 Mich. 236; 16 N. W. Rep., 388. North Birmingham St. Ry. Co. v. Calderwood	98	Ry. Co., Dietrich v., 58 Md. 350. Baltimore & Y. Turnpike Road v. Cason	4
City of Troy Kunze, v. 104 N. Y. 344; 10 N. E. Rep., 442. Weil v. Drydock E. B. & B. Ry. Co.	65	McClain's Appeal, 18 At. Rep. 1066. Appeal of Easton S. E. & W. E. P. Ry. Co.	117	Railroad Co. v. Prinnell, 3 S. E. Rep., 95. Richmond City Ry. Co. v. Scott	8
Cobrick v. Swinburne, 105 N. Y. 503; 12 N. E. Rep., 427. Tallman v. Metropolitan Elevated Ry. Co.	98	McCoy v. Nelson, 121 U. S. 484; 7 Sup. Court Rep., 1,000. American Cable Ry. Co. v. Mayor, etc., of the city of New York	175	Railroad Co. v. Hickey, 14 Allen 432. Baltimore & Y. Turnpike Road v. Cason	4
Clark v. Wooster, 119 U. S. 322; 7 Sup. Court, 217. American Ry. Co. v. Chicago City Ry. Co.	110	Munford, Railway Co. v. 3 Amer. & Eng. Co. 312-315; Birmingham Union Ry. Co. v. Smith	6	Railroad Co., Hill v., 10 N. Y. 329; 16 N. E. Rep., 61. Richmond City Ry. Co. v. Scott	8
Cone, Robinson, v. 22 Vermont 213; Winters v. Kansas City Cable Ry. Co.	119	Napheys, Railroad Co. v. 90 Pa. St. 135. 2 Wood Ry. Law, 1096, Note. 1 Whart Ev. Sec. 359. Birmingham Union Ry. Co. v. Hale	217	Reigle, Farrish v., 11 Grat. 697. Richmond City Ry. Co. v. Scott	8
Crouch v. Railway Co., 21 S. C. 495; Donahue v. Enterprise Ry. Co.	118	New Orleans v. Sugar Shed Co., 35 La. Ann. 548; City of New Orleans v. Crescent City Ry. Co.	9	Railroad Co., Cartwright v., 52 Mich. 606; 18 N. W. Rep., 380, Cooley, C. J. Richmond City Ry. Co. v. Scott	8
Carter v. Railroad Co., 19 S. C. 20; Donahue v. Enterprise Ry. Co.	118	Noonan, Wheelock v. 108 N. Y. 179; 15 N. E. Rep., 67. Tallman v. Metropolitan Elevated Ry. Co.	98	Railroad Co. v. Bingham, 87 Tenn. 522; 11 S. W. Rep., 705. East End St. Ry. Co. v. Doyle	9
City of Salem, VanHook v. 70 Ala. 361; Town of Oxanna v. Allen	5	New Orleans v. Water Works Co., 36 La. Ann. 432; City of New Orleans v. Crescent City Ry. Co.	9	Railway Co. v. Calderwood, 7 South Rep., 360. Birmingham Union Ry. Co. v. Smith	6
Cooper's Adm'r Railroad Co., 9 S. E. Rep., 321; Richmond City Ry. Co. v. Scott	8	New Orleans v. Railway Co., 28 La. Ann. 497; City of New Orleans v. Crescent City Ry. Co.	9	Railroad Co. v. Twiname, 11 Ind. 590; 13 N. E. Rep. 55. Richmond City Ry. Co. v. Scott	8
Calderwood, Railroad Co. v. 7 S.outh Rep., 350; Birmingham Union Ry. Co. v. Smith	6	Newell v. Railway Co., 27 N. W. Rep., 839; Williams v. City Electric St. Ry. Co.	118	Railroad Co. v. Cooper's Adm'r, 9 S. E. Rep., 321; Richmond City Ry. Co. v. Scott	8
Cartwright v. Railway Co., 52 Mich. 606; 18 N. W. Rep., 380, Cooley, C. J. Richmond City Ry. Co. v. Scott	8	Nelson, McCoy, v. 121 U. S. 484; 7 Sup. Court Rep., 1000. Nichols v. Railway Co. 38 N. Y. 131	64	Railroad Co. v. Munford, 3 Amer. & Eng. Ry. Cas. 312-315; Birmingham Union Ry. Co. v. Smith	6
Darwin v. Railway Co., 23 S. C. 531; Donahue v. Enterprise Ry. Co.	118	American Cable Ry. Co. v. Mayor, etc., of New York City	175	Railway Co., Poulin v., 61 N. Y. 621; Birmingham Union Ry. Co. v. Smith	6
Dakin v. Dunning, 7 Hill 33; Taylor v. Brooklyn Elevated Ry. Co.	120	Osborne v. Railroad Co., 35 Fed. Rep., 84; 37 Fed. Rep., 830. Williams v. City Electric St. Ry. Co.	118	Railroad Co. v. Findley, 76 Ga. 311; Richmond City Ry. Co. v. Smith	8
Dunning, Dakin v., 7 Hill 30; Taylor v. Brooklyn Elevated Ry. Co.	120	Prinnell, Railroad Co. v. 3 S. E. Rep., 95; Richmond City Ry. Co. v. Scott	8	Railroad Co. v. Taylor, 104 Pa. St. 306; Peoples Passenger Ry. Co. v. Hazel	118
Dietrich v. Ry. Co., 58 Md. 359; Baltimore & Y. Turnpike Road v. Cason	4	People v. Kerr, 27 N. Y. 204; Williams v. Electric St. Ry. Co.	118	Railway Co. v. Hughes, 87 Ala. 610; 6 South Rep., 413. Birmingham Union Ry. Co. v. Hale	217
Danville, Bovee v. 53 Vt. 190; Augusta & S. Ry. Co. v. Randall	217	Piolett v. Simmers; 105 Pa. St. 95; Peoples Passenger Railway Co. v. Hazel	118	Railway Co. v. Wilkinson, 30 Md. 232; Baltimore & Y. Turnpike Road v. Cason	4
Dorlan v. Railroad Co., 46 Pa. St. 520; Tallman v. Metropolitan Elevated Ry. Co.	98	Parsons v. Railroad Co., 113 N. Y. 355; 21 N. E. Rep., 145. Silberstein v. Houston, West St. & Pavia Ferry Ry. Co.	137	Railroad Co. v. Zebe, 33 Pa. St. 318; Baltimore & Y. Turnpike Road v. Cason	4
Doran Wilson, v. 110 N. Y. 101; 17 N. E. Rep., 688. Taylor v. Brooklyn Elevated Ry. Co.	120	Poulin v. Railway Co. 61 N. Y. 621; Birmingham Union Ry. Co. v. Smith	6	Railroad Co. v. Shearer, 58 Ala. 672; North Birmingham St. Ry. Co. v. Calderwood	98
Downer, Transportation Co. v. 11 Wall 129, by Field J. Birmingham Union Ry. Co. v. Hale	217	Railroad Co., Miles v. 6 South Rep., 696; North Birmingham St. Ry. Co. v. Calderwood	98	Railroad Co., Osborne, v., 35 Fed. Rep., 84; 37 Fed. Rep., 830. Williams v. City Electric St. Ry. Co.	118
Elhrgott v. Mayor, etc., 96 N. Y. 275; Uransby v. Dry Dock E. B. & B. Ry. Co.	119	Railroad Co., Parsons v. 113 N. Y. 355; 21 N. E. Rep. 145. Silberstein v. Houston, West St. & Pavia Ferry Ry. Co.	137	Railroad Co., Johnson v., 33 Fed. Rep., 499. Johnson v. Brooklyn & C. Ry. Co.	80
Ford, Vanderverter v. 60 Ala. 610; Birmingham Union Ry. Co. v. Hale	217	Railway Co., New Orleans v. 28 La. Ann. 497; City of New Orleans v. Crescent City Ry. Co.	9	Railway Company, Railway Company v., 28 Amer. La. Reg. 765; Canal & Carondelet St. Ry. Co. v. Crescent City Ry. Co.	25
Farish v. Reigle, 11 Grat. 697; Richmond City Ry. Co. v. Scott	8	Railway Co., Newell v. 27 N. W. Rep. 839; Williams v. City Electric St. Ry. Co.	118	Railroad Co., Smith v., 32 Minn. 1; 18 N. W. Rep., 827. Watson v. St. Paul City Ry. Co.	9
Findley Railroad Co., v. 76 Ga. 311; Richmond City Ry. Co. v. Scott	8	Railway Co., Mitchell v. 51 Mich. 236; 16 N. W. Rep., 388. North Birmingham St. Ry. Co. v. Calderwood	98	Reed v. Railway, 34 Minn. 557; 27 N. W. Rep., 77. Miller v. St. Paul City Ry. Co.	119
Gumb v. Railroad Co., 114 N. Y. 411; 21 N. E. Rep., 993. Uransby v. Dry Dock E. B. & B. Ry. Co.	119	Railroad Co., Root v., 105 U. S. 189; American Cable Ry. Co. v. Chicago City Ry. Co.	119	Railway, Reed v., 34 Minn. 557; 27 N. W. Rep., 77. Miller v. St. Paul City Ry. Co.	119
Green v. Railroad Co., 12 Abb. N. C. 124; Tallman v. Metropolitan Elevated Ry. Co.	98	Railroad Co., Snow v., 8 Allen 441, 448, 450; Magee v. West End St. Ry. Co.	117	Railroad Co. v. Stackens v., 79 N. Y. 464; Weil v. Dry Dock E. B. & B. Ry. Co.	65
Godfrey, Railroad Co. v. 71 Ill. 500; Chicago West Div. Ry. Co. v. Ryan	65	Railroad Co., v. Kane, 69 Md. 23; 13 At. Rep., 387. Baltimore & Y. Turnpike Road v. Cason	4	Railroad v. Sperean, 47 Pa. St. 300; Chicago West Div. Ry. Co. v. Ryan	65
Hartfield v. Raper, 21 Wend. 615; Winters v. Kansas City Cable Ry. Co.	119	Railroad Co., Johnson v. 33 Fed. Rep., 499. Johnson v. Brooklyn & C. Ry. Co.	80	Railroad Co., Snow v., 8 Allen 441, 448, 450; Magee v. West End St. Ry. Co.	117
Hickey v. Railroad Co., 14 Allen 432; Baltimore & Y. Turnpike Road v. Cason	4	Raper, Hartfield v. 21 Wend. 615; Winters v. Kansas City Cable Ry. Co.	119	Railroad Co. v. Miles, 6 South Rep., 696; North Birmingham St. Ry. Co. v. Calderwood	98
Hartel v. Holland, 19 Wkly. Dig. 312; Uransby v. Dry Dock E. B. & B. Ry. Co.	119	Railroad Co., Henderson v. 78, v. N. Y. 423; Newman v. Metropolitan Elevated Ry. Co.	120	Railway Co., Root v., 105 U. S. 189; American Cable Ry. Co. v. Chicago City Ry. Co.	119
Holland, Hartel v. 19 Wkly. Dig. 312; Uransby v. Dry Dock E. B. & B. Ry. Co.	119	Railroad Co., Hatfield v. 33 N. J. Law 251; Tallman v. Metropolitan Elevated Ry. Co.	98	Railway v. Sistunk, 85 Ala. 352; 5 South Rep., 79. North Birmingham St. Ry. Co. v. Calderwood	98
Huges, Railway Co. v. 87 Ala. 610; 6 South Rep., 413. Birmingham Union Ry. Co. v. Hale	217	Railroad Co., Hatfield v. 33 N. J. Law 251; Tallman v. Metropolitan Elevated Ry. Co.	98	Root v. Railway Co., 105 U. S. 189; American Cable Ry. Co. v. Chicago City Ry. Co.	119
Hill v. Railroad Co., 10 N. Y. 239; 16 N. E. Rep., 61. Richmond City Ry. Co. v. Scott	8	Railroad Co., Hatfield v. 33 N. J. Law 251; Tallman v. Metropolitan Elevated Ry. Co.	98	Railroad Co., Astor v., 113 N. Y. 93; 20 N. E. Rep., 594. In re Third Ave. Ry. Co.	10
Higgs, Railroad Co. v. 38 Kans. 375; 16 Pac. Rep., 667. Richmond City Ry. Co. v. Scott	8	Railroad Co., Hatfield v. 33 N. J. Law 251; Tallman v. Metropolitan Elevated Ry. Co.	98	Railway Co., Nichols v., 38 N. Y. 131; Birmingham Union Ry. Co. v. Smith	6
Hatfield v. Railroad Co., 33 N. J. Law 251; Tallman v. Metropolitan Elevated Ry. Co.	98	Railroad Co., Hatfield v. 33 N. J. Law 251; Tallman v. Metropolitan Elevated Ry. Co.	98	Railroad Co., Smith v., 87 Tenn. 626; 11 S. W. Rep., 709. East End St. Ry. v. Doyle	9
Henderson v. Railroad Co., 78 N. Y. 423; Newman v. Metropolitan Elevated Ry. Co.	120	Railroad Co., Hatfield v. 33 N. J. Law 251; Tallman v. Metropolitan Elevated Ry. Co.	98	Railroad Co., Sweeney v., 10 Allen 368. Baltimore & Y. Turnpike Road v. Cason	4
Ice Co., Birkett v. 110 N. Y. 506; 18 N. E. Rep., 108. Weil v. Dry Dock E. B. & B. Ry. Co.	65	Railroad Co., Hatfield v. 33 N. J. Law 251; Tallman v. Metropolitan Elevated Ry. Co.	98	Railroad Co. v. Whitefield, 44 Miss. 466. Richmond City Ry. Co. v. Scott	8
Johnson v. Railroad Co., 33 Fed. Rep., 499. Johnson v. Brooklyn & C. Ry. Co.	80	Railroad Co., Hatfield v. 33 N. J. Law 251; Tallman v. Metropolitan Elevated Ry. Co.	98	Railroad Co., Smith v., 32 Minn., 18 N. W. Rep. 827. Richmond City Ry. Co. v. Scott	8
		Railroad Co., Hatfield v. 33 N. J. Law 251; Tallman v. Metropolitan Elevated Ry. Co.	98	Railway Co. v. Higgs, 36 Kan. 375; 16 Pac. Rep. 667. Richmond City Ry. Co. v. Scott	8



Rich, Telegraph Co. v., 19 Kan. 517. Taggart v. Newport St. Ry. Co. ....	81	Spearen, Railroad Co. v., 47 Pa. St. 300. Chicago West Div. Ry. Co. v. Ryan. ....	65	U. S. v. Lissener, 12 Fed. Rep. 840. Morgan v. Jersey City and Bergen R. Co. ....	25
Railroad Co. v. Napheys, 90 Pa. St. 135; 2 Wood. Ry. Law, 1096, Note. 1 Whart. Ev. Sec. 359. Birmingham Union Ry. Co. v. Hale. ....	217	Smith v. Railroad Co., 87 Tenn. 626; 11 S. W. Rep. 709. East End St. Ry. Co. v. Doyle. ....	9	Vau Hook v. City of Salem, 70 Ala. 361. Town of Oxanna v. Allen. ....	5
Railroad Co. Saffer v., 5 N. Y. Supp. 700. Uransby v. Dry Dock E. B. & B. Ry. Co. ....	119	Stackens v. Railroad Company, 79 N. Y. 464. Weil v. Dry Dock, E. B. & B. Ry. Co. ....	65	Vanderverter v. Ford, 60 Ala. 610. Birmingham Union Ry. Co. v. Hale. ....	217
Railway Co., Werner v., 81 Mo. 368. Chicago West Div. Ry. Co. v. Ryan. ....	65	Smith v. Railway Co., 32 Minn.; 18 N. W. Rep. 827. Richmond City Ry. Co. v. Scott. ....	8	Wilkinson v. Searcy, 76 Ala. 176. Birmingham Union Ry. Co. v. Hale. ....	217
Smith v. Railroad Co., 32 Minn. 1; 18 N. W. Rep. 827. Watson v. St. Paul City Ry. ....	9	Sistrunk, Railway v., 85 Ala. 351; 5 South Rep. 79. North Birmingham St. Ry. Co. v. Calderwood. ....	98	Wooster, Clark v., 119 U. S. 322; 7 Sup. Court, 217. American Ry. Co. v. Chicago City Ry. Co. ....	119
Slack v. Brown, 13 Wend. 390, Taylor v. Brooklyn Elevated Ry. Co. ....	120	Snow v. Railroad Co. 8 Allen 441, 448, 450. Magee v. West End St. Ry. Co. ....	117	Wilson v. Doran, 110 N. Y. 101; 17 N. E. Rep. 688. Taylor v. Brooklyn Elevated Ry. Co. ....	120
Swinburne, Colrick v., 105 N. Y. 503; 12 N. E. Rep. 427. Tallman v. Metropolitan Elevated Ry. Co. ....	98	Twiname, Railroad Co. v., 111 Ind. 590; 13 N. E. Rep. 55. Richmond City Ry. Co. v. Scott. ....	8	Wheelock v. Noonan, 108 N. Y. 179; 15 N. E. Rep. 67. Tallman v. Metropolitan Elevated Ry. Co. ....	98
Shearer, Railroad Co. v., 58 Ala. 672. North Birmingham St. Ry. Co. v. Calderwood. ....	98	Traction Co. v. Bernheimer, 125 Pa. St. 615; 17 At. Rep. 477. Steiner v. Philadelphia Traction Co. ....	118	Water Works Co., New Orleans v., 36 La. Ann. 432. City of New Orleans v. Crescent City Ry. Co. ....	9
Sugar-Shed Co., New Orleans v., 35 La. Ann. 548. City of New Orleans v. Crescent City Ry. Co. ....	9	Traction Co. v. Bernheimer, 17 At. Rep. 477. Citizen's Passenger Ry. Co. v. Thomas. ....	98	Werner v. Railway Co., 81 Mo. 368. Chicago West Div. Ry. Co. v. Ryan. ....	65
Simmers, Piolett v., 105 Pa. St. 95. Peoples' Passenger Railway Co. v. Hazel. ....	118	Taylor, Railway Co. v., 104 Pa. St. 306. Peoples' Passenger Co. v. Hazel. ....	118	Whitefield, Railroad Co., 44 Miss. 466. Richmond City Ry. Co. v. Scott. ....	8
Sweeney v. Railroad Co., 10 Allen 368. Baltimore & Y. Turnpike Road v. Cason. ....	4	Transportation Co. v. Downer, 11 Wall 129, by Field, J. Birmingham Union Ry. Co. v. Hale. ....	217	Zebe, Railroad Co. v., 33 Pa. St. 318. Baltimore & Y. Turnpike Road v. Cason. ....	4
Saffer v. Railroad Co., 5 N. Y. Supp. 700. Uransby v. Dry Dock, E. B. & B. Ry. Co. ....	119	Telegraph Co. v. Rich, 19 Kan. 517. Taggart v. Newport St. Ry. Co. ....	81	Wilkinson, Railway Co. v., 30 Md. 232. Baltimore & Y. Turnpike Road v. Cason. ....	4



# The Street Railway Gazette.

(Copyrighted, 1890.)

VOL. V.

JANUARY, 1890.

No. 1

## BIOGRAPHICAL.

### James Clifton Robinson.

VICE-PRESIDENT AND SUPERINTENDENT LOS ANGELES (CAL.) CABLE RAILWAY.

Mr. James Clifton Robinson, the subject of this sketch, was born in Birkenhead, England, just 41 years ago. It was there that the now famous George Francis Train first obtained permission to lay down one of his primitive "step-rail" lines. One of the first disciples of this eccentric genius was Mr. James C. Robinson, and it is highly probable that the latter named gentlemen imbibed from his master that alertness which, coupled with his own natural ability, has now brought him up to the first rank of his profession.

Late in the '60's Mr. Robinson first visited America, where a too close application to work at his chosen profession undermined his health, and in '70 he had to return to his native country. Mr. Robinson was then in his 22d year, and he spent the next two or three years in acquiring experience in the construction, operation and management of street railways in London, Liverpool, Dublin and Cork.

In the summer of '75 Mr. Robinson was appointed general manager of the Bristol system of street railways—tramways, as they are called abroad—and, in a comparatively short time, he developed the then small system into a very extensive one, and did not quit that field of labor until he had served therein for nearly seven years.

Early in '83 Mr. Robinson was elected secretary and general manager of the Edinburgh Street Tramway Co., and there, by good management, he succeeded in reducing the operating expenses of the system from 79 per cent. down to 64 per cent., besides improving the service in every particular.

Not long after he had been connected with the Edinburgh Co., Mr. Robinson received an offer of the position of general manager of the Cable Corporation in London, into the service of which he entered in the beginning of May. Upon leaving Edinburgh, a handsome testimonial was presented to him by the directors.

His first task upon his arrival in London was to complete the construction and equipment of the Highgate Hill Cable Tramway, which line was formally opened by the Lord Mayor with a great ceremonial on the 29th of April, '84.

This was the first cable road ever operated in Europe, and its construction and workings were admirably described in a neat little pamphlet issued by Mr. Robinson at the time.

Shortly after the opening of this line, Col. Robinson became a consulting and organizing manager of street railways in general, in which

capacity he was frequently called upon to give evidence regarding new schemes before committees of both Houses of Parliament. The construction, management, organization and re-organization of these lines occupied his time until, having secured some valuable patent rights in the United States, he returned to this country after an absence of eighteen years. When in Chicago he was invited by Mr. Holmes to assume charge of the Los Angeles Cable Ry., which is now one of the finest systems of cable railway in the world.

Mr. Robinson was the first president of the

work he had so well carried out. Among the gentlemen present were the following: S. M. White, Henry T. Hazard, W. H. Workman, E. W. Jones, W. J. Broderick, F. Q. Story, Dan McFarland, Z. D. Mathews, Charles Forrester, Stern and Loeb, C. F. Heinzeman, Fred Harkness, Baron Rogniat, W. T. English, C. F. Fisher, M. A. Foster, James B. Lankershim, W. H. Clark, A. B. Hotchkiss, W. H. Gucher, John W. Green, W. C. Furrey, A. C. Pomeroy, Hervey Lindley, S. M. Perry, I. H. Polk, J. Cross, Geo. J. Ainsworth, R. H. F. Variel, George W. Kimball, E. H. Sanderson, William Lacy, William Pridham, Robert S. Baker, W. H. Perry, Len J. Thompson, John M. C. Marble, Walter S. Moore, Charles Silent, H. T. Lee, F. K. Ainsworth, G. J. Griffith, George J. Denis, J. H. Davison, Sutherland Hutton, H. Siegel, H. J. Woollacott, G. A. Dobinson, Mr. Crowley, Southern Pacific Railroad, S. B. Hines, R. S. C. Chapman, Colonel Ayers, M. R. Higgins, J. W. Green, J. A. Muir, Judge S. A. McKinley, George Gebhart, J. E. Playter, W. A. C. Moore, Wm. Burr and Boyle Workman, representing the engineering and operating departments of the cable system, Judge S. C. Hubbell and J. J. Aiken representing the local directors of the road, and a representative of the STREET RAILWAY GAZETTE (Chicago).

Among the speakers were Ex-Mayor H. T. Hazard and S. M. White, who responded to the toast, "What has the Cable System done for Los Angeles?" Mr. White said that the cable system had brought together into a concentrated whole, and brought centre and suburbs into close relationship. He also stated that it had started a boom in the city, or, rather, resurrected the old one.

"Los Angeles' Progress" was responded to by Major E. W. Jones, while "Our Honored Guest" was ably taken care of by Judge S. C. Hobwell, who drew a sketch of Col. Robinson's life and stated what a good thing it was for Los Angeles that Mr. Robinson had taken up his residence there.

Col. Ayers made an excellent response to "The Press," while Hon. R. H. F. Variel made a humorous address on "Street Railroads, Past and Present." Judge W. H. Clark of the Supreme Court responded to the toast, "The Ladies," and his words were a concentration of sense, wit and genius.

Col. W. R. Moore, who is conceded to be the Chauncy Depew of Los Angeles, made a very amusing speech in response to a toast, "The Men," by which he kept the audience in a continual uproar of laughter and applause.

Col. J. C. Robinson of course acknowledged his appreciation of the compliment paid him, in a graceful, straight-forward manner, modestly giving credit to everybody else except himself, for the achievement of the great work.



*J. C. Robinson.*

Tramway Institute of Great Britain. He is an active, aggressive and vigilant street railway man, and in his management of the affairs of the Los Angeles Cable Ry. Co. he has shown executive ability of no mean order.

BANQUETTED.

A banquet was given to Col. J. C. Robinson, Vice-President of the Los Angeles Cable Co., on the night of December 17th. It was tendered at the instance of a number of prominent citizens of Los Angeles, who took that opportunity of showing Col. Robinson their appreciation of the



## ELECTRIC RAILWAYS.

## That Richmond Road.

[We are in constant receipt of letters as to why the Richmond road was a failure (we never held it to be a failure), and in justice to those gentlemen to whose pluck, enterprise and nerve the equipping of the road with electricity was largely due, we feel it to be only a matter of justice to publish the following explanation recently received from them].—ED.

In the early part of 1887, Mr. Maurice B. Flynn of New York visited Richmond, Virginia; obtained a franchise for this Richmond Union Passenger Railway; and at once made with it, on behalf of his own firm of Guy C. Hotchkiss, Field & Company, a "construction contract."

It was a profitable franchise and earned large revenues, but they were diverted from the day it began operations, and large sums from its income which have been represented as chargeable to its running expenses were withdrawn by Flynn, on vouchers which are not now among its papers.

Mr. Flynn further formed an electric company principally owned by himself, and to that company he leased all the power-plant of the Union Passenger road at a very low figure, and then made a contract with his electric company to supply the railroad with power from its own plant at \$50 a day.

When Mr. Flynn obtained his construction contract, he made sub-contracts to carry out the same as follows:

For the construction of the road-bed he gave the contract to a business associate at a very large price, part of which was paid in cash and part in bonds.

The road-bed and track were built in the most perfunctory manner. The work was badly done, the rails were of inferior quality; and the whole contract was so wretchedly performed that the condition of the road-bed and track to-day is one of the most serious of all the troubles with the Richmond Passenger Railway Company.

The road-bed was not properly ballasted; the curves were abrupt and unbound; and although the track has been laid but two years, the condition of the rails to-day is so wretched as to necessitate a large expenditure, amounting to upwards of \$12,000, in order to replace the iron already worn out and to make the track fit for any method of propulsion.

The following is an extract from the report of Chief Engineer Greene, under date of October 2, 1889, as to the present condition of the track:

"The road was very poorly built originally, even supposing that horse cars were to be used on the line. Stringers were placed from four to eight feet apart, instead of being three feet apart as they should have been. There was no attempt at ballasting the road, and in consequence the track is very much out of level in places. During the winter of 1887 and 1888, the railroad company was forced to pave some of its curves on the unpaved streets in order to keep the rails from spreading and the cars getting off the track. On the eastern portion of the road it also put in about one hundred loads of cinders from the gas house, as it was utterly impossible otherwise to keep the track in sight. On the main line, comprising the double track portion, the Churchill loop and the 17th street line, the rail is a 45 pound tram-rail, laid on stringers and cross-ties in the usual way, except that the ties are placed every five feet instead of three feet. From the end of Clay street west to a certain point on Ashland street, a distance of about 10,300 feet, also on the 5th street branch, a 30 pound tram rail is used which is entirely too light for ANY electric street car service. Beyond this point, and to the terminus of the road a 40 pound 'T' rail is used, which is in fairly good condition. I estimate that the following work should be done on the track at once in order to make it even reasonably good to run on. On the Churchill loop to 21st street and Franklin street, about 20 per cent of the rails are badly worn, and should be relaid. This would require about 35 tons of new rail, and the cost would be about \$2,000 for relaying. From 21st and Franklin to 12th and Franklin, a distance of about 7,000 feet, about 25 per cent of the rails should be relaid. This means about 25 tons; estimated cost of about \$1,500. From 12th and Franklin to Hancock and Clay, a distance of about 13,200 feet of track, about 33 per cent of the rails require relaying; that is about 80 tons of new rails, estimated cost about \$4,700. The 30 pound tram-rail on the main line from Hancock to Clay west, a distance of about 11,800 feet should be entirely relaid, as this track is in very bad condition, and is entirely too light for the work to which it is subjected. Most of the distance the track is outside of the city limits, and 'T' rails should be used. I am informed that even within the city limits 'T' rails can be used. On this section about 150 tons of iron will be needed, and its weight should not be less than 40 pounds to the yard; estimated cost of relaying about \$8,000. This brings the total cost of re-constructing the track to about \$16,200, which makes a liberal allowance for

labor and material, besides giving a margin for some necessary ballasting with gravel on the western section. The old rails can be sold probably for \$15 a ton, and the total realized from the sale of old iron would amount probably to about \$3,700. This would leave as the net outlay on the track about \$12,500."

With this branch of the building of that road the Sprague company has never had any connection, and that so much of the track has to be relaid after less than two years' use conveys to the minds of railway men its own moral.

Mr. Flynn and his associates made the contract for the power house and plant, and the electrical equipment of said road.

At a time when the Sprague company was anxious to obtain a contract for equipping a street railway. The Richmond road afforded the desired opportunity, and was then the largest undertaking of its kind in the world. The advantages to be obtained from its successful performance have since been abundantly demonstrated, and need no amplification.

The contract was awarded to this company before the route had been actually located. It entered upon the performance of that contract with a full knowledge that the conditions of road-bed, track, curves and grades would severely test all the features of its system; and it very soon learned, that as to the road-bed, track and car house facilities, it was subjected to unfair and very trying drawbacks in excess of the representation made to it by the contracting parties.

From the outset it became apparent that Mr. Flynn, while exacting the letter of this company's contract, had no purpose to spend a dollar, or use any exertion to aid it. The contract under which the work was undertaken contained conditions very exacting, and forfeitures for not completing at the time named. Serious delays occurred from the condition of the road-bed and track, from extraordinary weather and other causes. Mr. Flynn then made most exaggerated claims for abatements and diminutions by reason of these delays.

The road was completed about March 1, 1888. Whatever may be said by the present management, the work of the road, as delivered, was satisfactory, and the earnings large, as is evidenced by the following letter which was sent to this company signed by the whole committee of construction, of which Maurice B. Flynn was a member:

"We take pleasure in notifying you of our acceptance of the electrical equipment of the Richmond Union Passenger Railway. The road which you have equipped under most trying conditions has been one of the most difficult if not the most difficult, which could be met with in street railway work.

"The excessive and continuous grades, the numerous and sharp curves, the gradients in these curves, the weight of the cars and the heavy loads which they have been required to carry, together with the extent of the system and the number of cars in operation, constitute an enterprise the largest and most difficult yet inaugurated in any part of the world.

"We must confess that we have sometimes shared the doubts that others have been so free to express as to the possibility of the successful completion of this work; and hence it is with the greatest pleasure that we acknowledge the successful fulfillment of all the terms and conditions of the contract, and compliment you upon having achieved so signal a success.

"The immediate financial success of the road has been unquestionably due in a large measure to the economy developed in the operation of your system as compared with that of any other method of street car propulsion."

This strong statement of the efficiency of the equipment was given after ample tests of the equipment under proper management; the cars had been as heavily laden and the equipment as severely strained during that period as they have ever been since. This would seem to answer the complaint now made that the equipment is too light for the service to which it is assigned, although we confess that experience has shown that they ought to have a heavier outfit, and the work is much heavier than was contemplated. The fact is that the present condition of the Richmond Union Passenger Railway company is not primarily attributable to the Sprague company, but is largely due to the wretched bad management of that road in its every department and to the bankrupt independence with which it has been conducted.

From time to time after Mr. Flynn and his associates accepted the equipment, this company furnished the material required in the ordinary operation of the road, on their order. The bills for such material were presented, but never paid.

They gradually amounted to a considerable sum; and this company, finding that it could get no money from the Union Passenger Railway, refused to furnish any more material until its old bills were paid.

The bulk of our bill was made in 1888. The company never having paid a dollar on this account, the Sprague company refused to give it further credit. The management then undertook to make its own replacements and repairs, and for many months the Sprague company had practically no communication with the road.

This company always insisted when it was upon the most friendly relations with Mr. Flynn and his management that the Richmond Union Passenger Railway company should have a skilled mechanic in charge of its outfit; and the Union Passenger Railway management pertinaciously neglected that demand.

As to the present condition of its equipment, we deny the responsibility of this company. We aver that any candid person looking at the present outfit of the road can discover neglect in every detail. Take for example its cars. They were handsome, neat, attractive cars purchased from J. G. Brill & Company. To-day they are shabby, weather-worn, filthy and neglected; so much so that any visitor to Richmond is struck by their untidy and neglected appearance. Mr. Greene's report as to the cars was as follows:

"We now come to the last and most important item of the equipment, and that which shows most clearly the lack of proper management that the road has received.

Our original contract called for the equipment of 40 cars—30 closed cars and 10 open cars, all made by the Brill Car company. These cars were new two years ago, yet in spite of this fact they look to-day as though they might be 15 or 20 years old. The outside of the cars are scarred and scratched and the paint rubbed off, and the inside of the cars are battered and dirty. I counted no less than 15 dashboards which had large holes knocked into them where one car had evidently run into another. On several cars long scars or grooves were cut on the sides, showing where cars had collided with each other, probably at turnouts. The wheels on all of the cars are in very bad condition, the flanges on many of them being worn nearly entirely away. Three of the new cars which were intended for the City road have been robbed of their wheels and axles to put under the Union Line's cars, and yet, in spite of this fact, there is hardly a car on the line of the Union road that has wheels which are fit for them to run on; in fact some of them are absolutely unsafe.

"The car bodies indicate plainly by their appearance that the cars have been very roughly and badly handled, and that they have received little or no attention as to cleaning. In addition to this, the cars have for nearly a year stood out in the street at night, there being no shelter for them. This naturally did not tend to improve their condition or appearance."

As to the portion of the equipment furnished by this company, an inspection of it will at once demonstrate who is responsible for its present condition. Whether it is good or bad, there is a certain sort of care of this class of machinery which is necessary, and the utter lack of which is palpable upon sight of this machinery. It has been allowed to become loose, rickety and neglected. A car as run under the present management rattles and bangs along the streets of Richmond like a load of wagon tires.

Such repairs as have been placed upon them have been made in the most unskillful and awkward way, and many of the machines, as they have been patched up, look more like the work of an ignorant blacksmith than that of a skilled mechanic.

"A penny wise and pound foolish" economy has marked the care of this machinery, and the failure to expend small amounts necessary to prevent great losses has caused general deterioration of the Richmond Passenger Railway in this as in every other department.

We state this as a fact, without meaning to blame anyone, and if asked why the fact existed, our answer would be that the enterprise has been first crippled and deprived of its legitimate revenues, and then kept alive by living from hand to mouth.

The following is Mr. Greene's report of the condition in which he found the machinery on September 30th, 1889:

"The motors themselves are in a deplorable condition. The management seems to have given up even a pretense at cleaning and inspecting the machines even at night, and the machines are covered with dust, oil and dirt, to a depth in some places of three-fourths of an inch. What would become of a railway locomotive thus treated?

"Since we have refused to furnish supplies to the railway company, they have been getting parts of the machines made in Richmond, such as gears, bearings, etc. The cheapest material was used and the gears lasted a remark-



ably short time, although they were used until the teeth were perfectly knife edged. I also found that they had recently attempted the construction of commutators in Richmond with the natural result that every one that they put on armatures gave out within a few hours after it had been put in service. I found that armatures after having been repaired, and while the shellac was yet green on them, would be put into a motor and slapped on to a car and started out to climb a 10 per cent grade, within an hour after it had been finished. The inevitable result was, of course, the disabling of the armatures.

"The above will give you some idea of the utter want of knowledge, judgment, or even common sense, shown in the care of handling and repairing of the machines.

"From the way in which the repairs are done and the utter lack of inspection and cleaning of the machines, it is a wonder to me that there are any cars left to run on the road at all."

Mr. Greene is most surely sustained in his general view by the condition of the horse-car railway in Richmond, which is under the same management. Its condition is the best evidence as to where the responsibility rests. Flynn bought the horse-car line about a year ago. As to that, there can be no pretense of a failure of electricity or failure of the Sprague company. Yet the management of the horse-car railroad has deteriorated since his purchase as seriously as that of the electric road.

The following extract from an editorial of the *Richmond State*, one of the leading newspapers of Richmond, under date of Sept. 26, 1889, shows this:

**NO EXCUSE FOR INSUFFICIENT SERVICE.**

The Union Passenger Railway company—the electric line—is to be reorganized. The stockholders state that they are desirous of improving the service, and they estimate that they will do so at a very early day. The city granted the Union Passenger company privileges which were considered exceptionally liberal, and the service on its line should be reasonably satisfactory. Making due allowance for the experimental stage through which the electric system was passing, there has been little excuse for the miserable service

worse, until to-day it is such as would disgrace a town of 5,000.

From this local and certainly impartial testimony, it is evident that the radical trouble is not with the electrical equipment. The following extract from a letter of October 2d, 1889, from

proper schedules for running cars, I believe the service would be greatly improved by having larger, neater and better constructed cars, using two tug horses on heavy grades instead of one, as now, with the small cars. Conductors should be employed, not only for the convenience of passengers, but to leave the drivers free to watch for signals from persons on the side streets when hailing the cars. I believe the drivers would be more on the alert if they had fewer hours of work, say in two reliefs of nine hours each.

Very respectfully,  
W. E. CUTSHAW,  
*City Engineer.*

This company, convinced that its reputation could no longer be left to the mercy of such management, united with the majority of the bondholders, with whom it is in perfect accord, to put the road in the hands of a receiver.

The board of directors of the Union Passenger Railway met in Richmond, October 10th, 1889, and the result of their meeting was the election of a new executive committee of which the president of this company was made a member, and it is their intention to put the Sprague equipment at Richmond in thoroughly effective condition.

**SPRAGUE ELECTRIC RAILWAY MOTOR CO.**

EDWARD H. JOHNSON, Pres.

**Electric Locomotive for Mining Tramways.**

The accompanying illustration shows the 10 H. P. new electric mining locomotive as built by the Sprague company, and for symmetry, compactness, and all the requirements of haulage in mines, will recommend itself to mining operators. This locomotive is a modification of the Sprague street railway motor, which is connected by a series of gears with the axle. It is very simple in construction, and all the requirements of com-

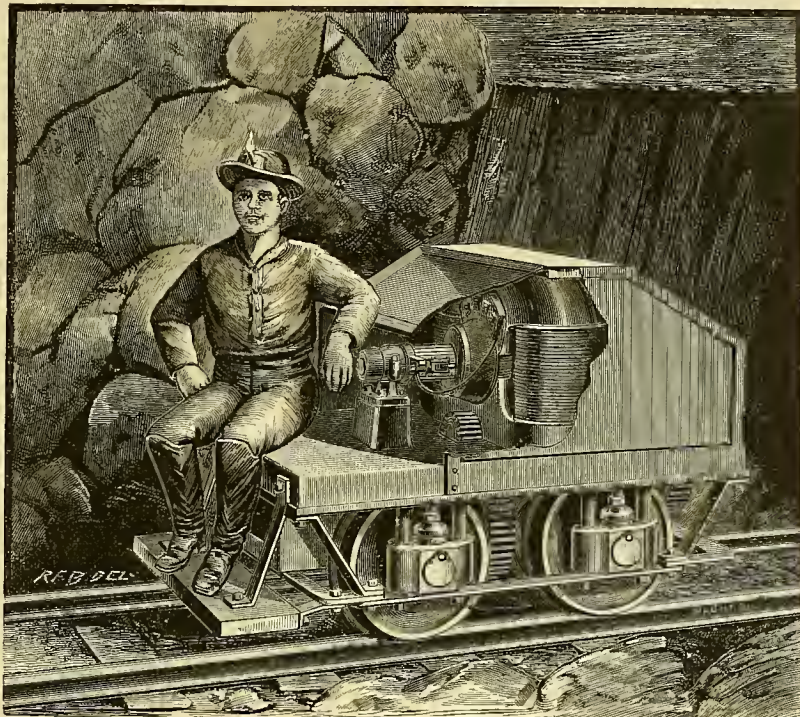

ELECTRIC LOCOMOTIVE FOR MINING TRAMWAYS.

the City Engineer shows that the horse-car line is causing more complaint and giving as little satisfaction as the electric line:

CITY ENGINEER'S OFFICE, }  
RICHMOND VA., October 2, 1889. }

Hon. J. Taylor Ellyson, Mayor,

DEAR SIR: \* \* \* \* With the present number of



SOUTH BROADWAY LINE, ST. LOUIS. (Short System.)

which has been offered the public during the past six months.

But if the public was asked to be patient with the Union Passenger company's management, there was never any reason why the public should be asked to tolerate an inferior service on Main and Broad streets. The City Railway company had been giving the public an excellent service up to the time of the sale of its property to the Union Passenger syndicate. The Main and Broad street lines were paying, but from the day the ownership changed the equipment began to deteriorate; the service grew worse and

cars (20), and equipment of the City Railway, there is no difficulty in arranging a schedule by which cars can be run each way continuously from 6 a. m. to 12 p. m., at intervals of ten minutes over both the Main street line from our sheds at West Main to Fulton, and over the Broad street line from near Hollywood to Libby Hill; and adding ten more cars to the service, the intervals can be shortened to five minutes on those portions of both lines between Monroe Park and Libby Hill.

The inclosed map and time tables will show how these schedules or better ones can be arranged. In addition to

binning energy in a limited space have been thoroughly considered in this machine. It is now offered to mining operators as a decided improvement on the older methods of trail ropes, mules, etc. The outside dimensions of the 10 H. P. for an 18-inch gauge, are 30 inches in width, 30 inches in height, 62 inches in length, the total weight is from 3,000 to 4,000 lbs., and is very easy and simple in operation,



### South Broadway Line, St. Louis, Mo.

The South Broadway Line has received its new equipment from the Short company and began operation again the middle of December. During the trial of the road in May and June the surprising increase in business demonstrated the fact that the equipment was too light. Arrangements were at once made for a heavier outfit and the present road will be equal to any demands that can reasonably be expected in ten years.

New track has been laid throughout with 80 lb. Johnson girder rails. The engine house—cut of which we are promised for our next issue—is a model of its kind, having every appliance and device for the control and protection of the electrical equipment known to the electrician and engineer.

The expense of operating a car a day during the trial was \$2 59½. It is confidently expected that the present equipment will be more economical as well as more efficient. The road is watched with great interest by street railway officials, as it is owned and controlled by the most pronounced cable men in the country.

### New Electric Headlight.\*

In this headlight, the connecting cable of the lamp is passed through and fastened to the bottom of the headlight; the cable is about two feet long, on the end of which is a plug, which, when in position, is inserted in a socket fitted on to the car frame immediately underneath the dash board. When it becomes necessary to remove the lamp from one end of the car to the other, the plug is pulled out and left hanging to the headlight, which is lifted off the dash board without any chance of a short circuit, the electrical contact being entirely broken.

The headlights have an eight or ten-inch reflector, and are fitted out complete with a sixteen candle power incandescent lamp, which lights the track brilliantly for over two hundred feet ahead.

### Storage Battery Plates.

E. R. KNOWLES.

In addition to the question of the density of the active material in storage battery plates, as discussed in a former article, there are other points which arise, such as the best shape to

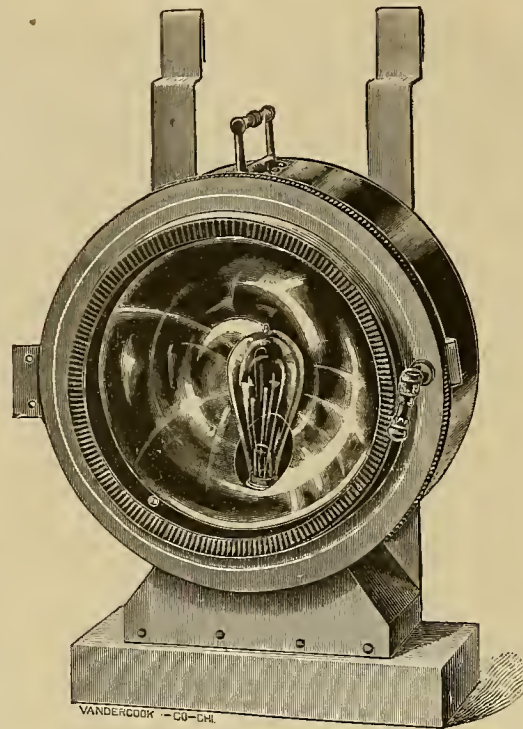

NEW ELECTRIC HEADLIGHT.

make the plate, its best dimensions, the shape of the perforations in the plates, the metal from which the plates are made, the method of connecting the plates together, and the character of the active material employed to fill the perforations in the plates. On all these points there is wide diversity of opinion, and it is the writer's

urged to a deep plate is that immersing in the electrolyte, which has a tendency to become more dense at the bottom of the plate than at the top, subjects the plate to different degrees of chemical action at different parts of its surface, and a long rectangular plate has been urged by some to be a better form. This style of plate takes up unnecessary room, and, being long and narrow, its tendency will be, unless well supported, to warp out of shape much more easily than the square form. The square plate seems to be the one most generally in use. As to the thickness of the plate there is also a diversity of opinion, some claiming that the plates should be as thin as possible, and a large number of plates to the cell, so as to expose as large a surface of active material as possible; while others prefer to have a few quite thick plates with a limited amount of surface of active material exposed, but with a large mass of active material. There is a proper mean between these extremes. Very thin plates are difficult to keep flat and true under the usage to which they are subjected in actual practice. They will warp and curl, no matter how many separators are placed between them. The plates should be thick enough to be rigid and able to withstand any tendency to bending or warping which may exist, exposing a reasonable amount of surface of active material, and yet containing enough active material in as dense a condition as is practicable to be able to give a maximum current discharge for a given period of time.

The shape of the perforations or cavities in the plates into which the active material is placed also plays a very important part in the proper proportioning of the plate. Every conceivable shape of hole has been used. Three general types cover most of them; those in which the hole is larger at the surface of the plate than it is at its center, those in which the hole is of the same diameter all the way through the plate, and those in which the hole is larger at its center than at the surface of the plate. Besides these there are plates which have cavities made in their surfaces which do not extend through the



SOUTH BROADWAY LINE, ST. LOUIS. (SHORT SYSTEM.)

They can be used with the ordinary five lamps in a car by the use of a three-way switch on each platform, thus leaving either four lamps inside or three inside, and one on the rear platform, the fifth one being within the headlight frame.

\*Sprague Electric Equipment Co., Chicago.

purpose to state such results as are the outcome of his own personal experience. In the first place, as to the plate itself, its shape and dimensions. Almost every conceivable shape has been devised and tried; but it seems to be generally conceded that a rectangular shape, approximately square, is the best shape. One objection that may be

body of the plate, and plates which are practically hollow, having one large cavity, whose walls are perforated and in which cavity the active material is placed. We have a regular evolution of the idea of a perforated plate, beginning with the smooth plate used by Plante, then the plate with the roughened surface, the



small cavities so made getting gradually larger and deeper until their extremities come together and extend clear through the plate, when we have the perforations larger at the surface of the plate than they are at its center. The central diameter of these holes gradually enlarges until we have them of uniform diameter throughout, giving the second type of perforation. The central diameter is then enlarged, and we have the third type of perforation, in which the diameter at the surfaces of the plate is smaller than the central diameter. Finally, we have the hollow plate, in which all the holes are merged into one large cavity, with perforated walls, the latest form of plate. The worst form of all is the one in which the perforation is largest at the surface of the plate and smallest at the center. It is mechanically incorrect, for no matter how carefully the active material is placed in it, the slightest change in the bulk of the active material ultimately results in the plug splitting apart at its center; loosening and being forced out of the plate. The straight hole, the one with the same diameter throughout its length, is much better and is largely in use. The best of these three forms is the one in which the central diameter is larger than at the surfaces of the plate, changes of bulk of the active material tending to make the plug fit more tightly. All plates made with perforations which extend clear through the plate are objectionable on account of the large amount of inactive metal that has to be left in the plate to the exclusion of active material. A form of plate which obviates in a great degree this difficulty is one which is practically hollow, consisting of two plates of thin, perforated metal with the active material placed in the cavity between them, the whole being fastened together in some suitable way. It would therefore seem that a square plate of reasonable thickness, which is practically hollow and filled with the active material, its walls being perforated, would

makers of secondary batteries use nothing but lead for the metal from which their plates are made. This is unsatisfactory, as every time the cell is charged and discharged a certain portion of the metal composing the positive plate is changed into active material, causing the plate to swell or grow and ultimately become entirely disintegrated and useless. It is also very soft and flexible, and will warp and curl easily under the various strains to which they are subjected.

one connection, along the tops of the plates, leaving the other portion of the plates practically free, would be the best. The plates should also be separated by elastic separators, which, while keeping the plates apart, still allow them to come and go as occasion may acquire. In other words, the whole cell, while it is properly connected electrically, should still be elastic in its character, so as to readily conform to all the varying forces to which it may be subjected. The

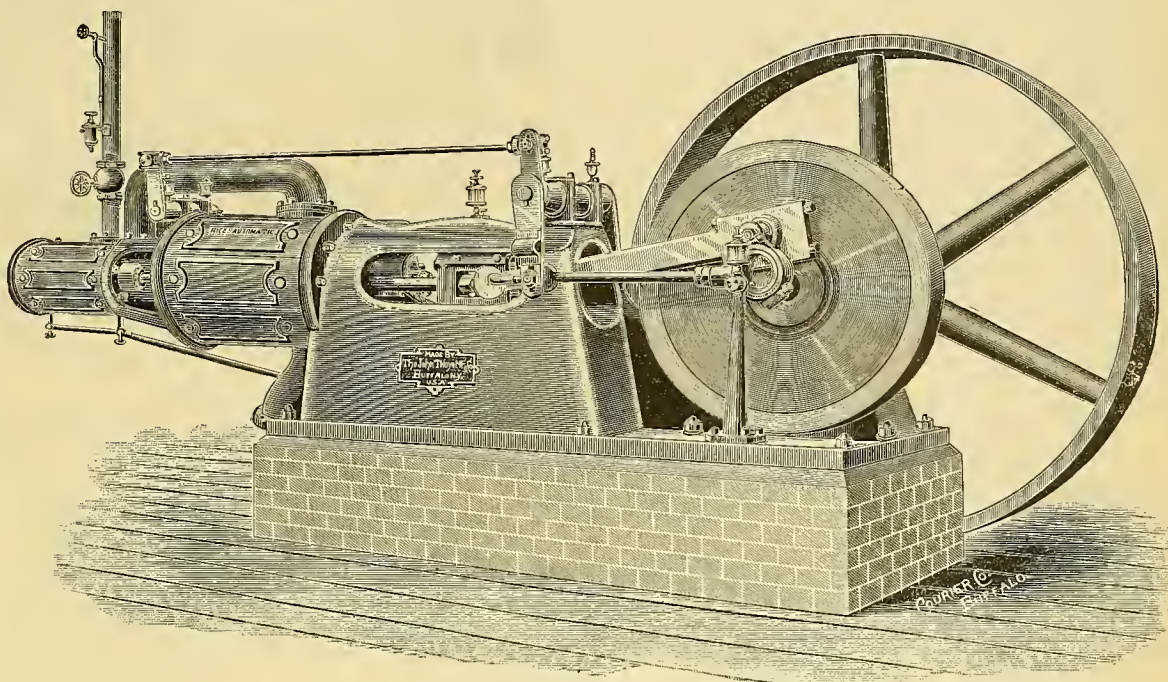

RICE AUTOMATIC TANDEM COMPOUND CONDENSING ENGINE. FIG. 1.—SIDE ELEVATION.—CRANK SIDE. See Page 6.

An alloy of lead with other metals, which is not attacked by the chemical reactions which take place in the cell, is far preferable, being stiff and rigid, and permitting the plates to be made much lighter in weight than if made solely from lead, no allowance being needed for the constant corrosion which would take place with a lead plate. Whatever metal the plate is made from should be practically unattackable when in the electrolyte. In connecting a number of plates

falling out of the active material from a plate, is in the main due to the character of the material employed, whether it changes its bulk to any degree under the varying chemical combination through which it passes in active use. For instance, the different oxides of lead each occupy more space than the actual mass of the lead from which they are made; also, if one oxide is changed to another its mass increases or diminishes, as the case may be. The same holds good

when the oxides are changed to a sulphate — it occupies a larger space than the oxide from which it is made. Now, if a plate is filled with an oxide, which in the process of formation is raised to a higher oxide, or is sulphated, the new form of material will increase in bulk and tend to occupy a larger space than it did before formation. There will not be room enough in the plate for it, and something has ultimately got to give. Either the plate will warp or curl, or the active material will be forced out of the plate, or both results may take place.

It is sufficient to say that the active material must be put into the plate in such a form that these evils may not occur. This can be done, and done successfully, as the writer has amply demonstrated, and thereby nearly, if not all of the tendency to warp and buckle, and the active material to fall or to be forced out of the plate, be obviated. To sum up, then, a plate of an inoxidable alloy of square or nearly square shape, of a proper thickness, approximately hollow, with its walls perforated

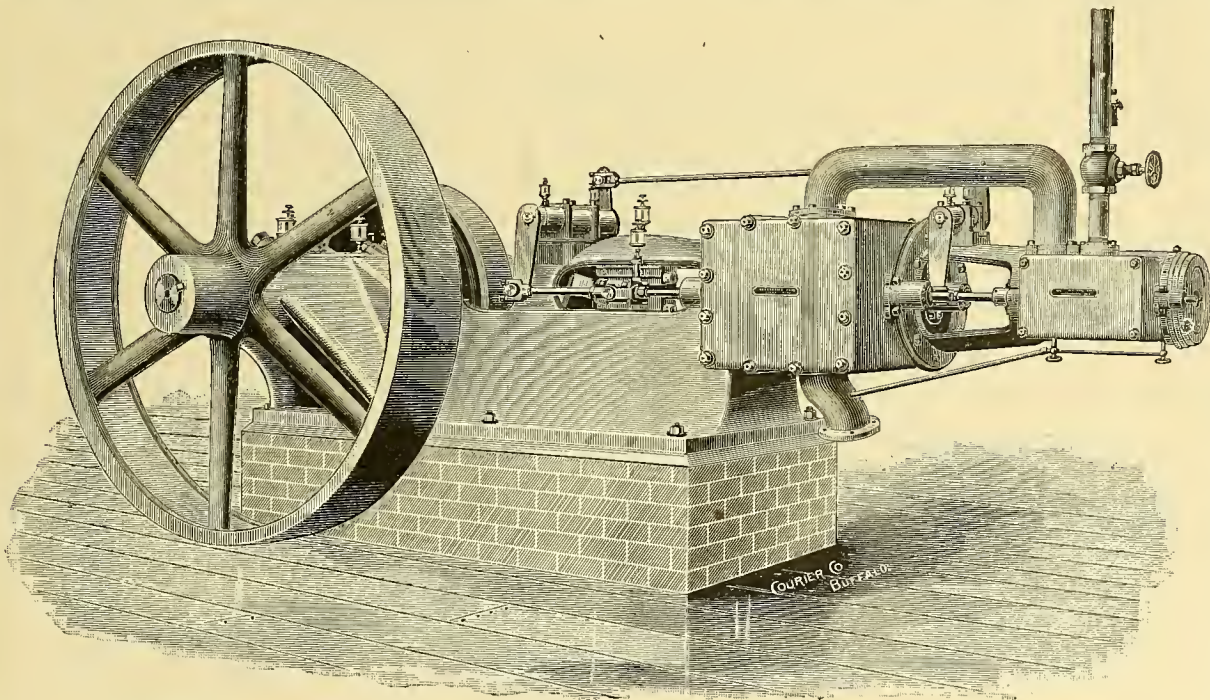

RICE AUTOMATIC TANDEM COMPOUND CONDENSING ENGINE. FIG. 2.—SIDE ELEVATION. VALVE SIDE. See Page 6.

be the best for practical purposes, it not being likely to warp or bend under ordinary conditions, nor to allow the active material to fall out, and offering a maximum of active material with a minimum of inactive metal.

The character of the metal from which the plate is made is another important consideration. It should be of a character not altered by the chemical action which takes place in the cell during charge and discharge. A great many

together to form a cell, care should be taken not to connect them so rigidly that they will not be free to move, if necessary, under the varying conditions to which they may be subjected. Plates will expand and contract more or less when in use, and this must be allowed for in connecting them together. Some makers connect a set of plates rigidly together at more than one point. If any tendency to buckle exists, this only increases the difficulty. It would seem that

and the active material of a proper kind and density placed in its interior, so arranged as to have a maximum of active material with a minimum of inactive metal, would seem by present experience to be the best form of plate, and a cell which, while connected so as to give sufficient conduction to electric currents, is yet elastic enough to accommodate itself to such variations as it may be subjected to, the best arrangement of cell.



### Rice Automatic Tandem Compound Condensing Engine.

The accompanying illustrations\* relate to the newest and most economical type of compound tandem engines.

The frame is of the same form as that used for standard Rice engines and can be made self-contained or with an outside bearing to suit special local requirements.

The governor is inside the crank-disk; both high and low pressure valves are operated automatically by the governor.

A good idea of the connections in the valve motion may be got on reference to Fig. 3. Either valve can be set independently of the other, while the engine is in motion. The valve itself is an ordinary four-port or gridiron valve. It is perfectly balanced from all pressure higher than the exhaust. To illustrate, it is stated that, with a full head of steam on, both valves can be moved by the pressure of two fingers on the valve stem. The valves take steam from the inside, so that they can be operated with the chest cover off if it is desired to ascertain whether they are tight.

The pressure plate shown in the engraving in

ground at the station, and also sometimes by short wires to each other, and also the negative terminal of the dynamo. The motors are represented at 1, 2 and 3. If any one of the distributing wires breaks, the cars are not stopped, unless a good ground connection is made by the broken wire, in which case the dynamo is short circuited; that is, it has a path of practically no resistance made for the current, and the dynamo will, therefore, generate an abnormal amount of current. When this occurs an automatic device opens the circuit and the dynamo no longer supplies current to the line. If the trolley wire breaks and falls on the track a similar short circuit occurs. If it should not happen to make a ground, no interruption takes place until a car reaches the break, and then it must evidently stop.

ation of the system can follow. If a trolley wire breaks the car stops when it reaches the break. If a telephone wire falls across one wire, and the conductors of the railroad are well insulated,

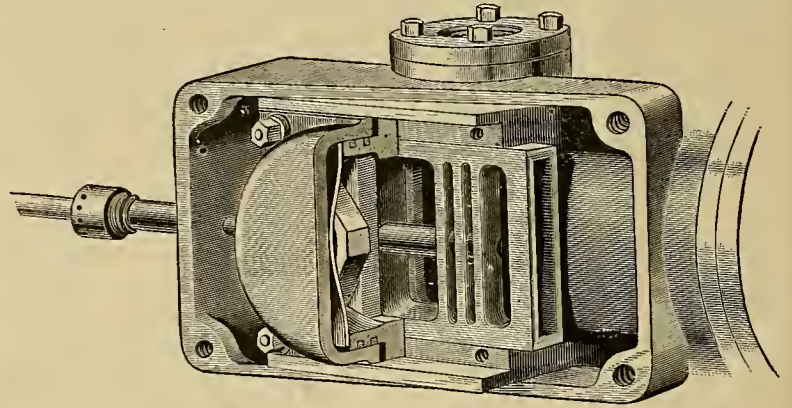

RICE AUTOMATIC TANDEM COMPOUND CONDENSING ENGINE. FIG. 3.

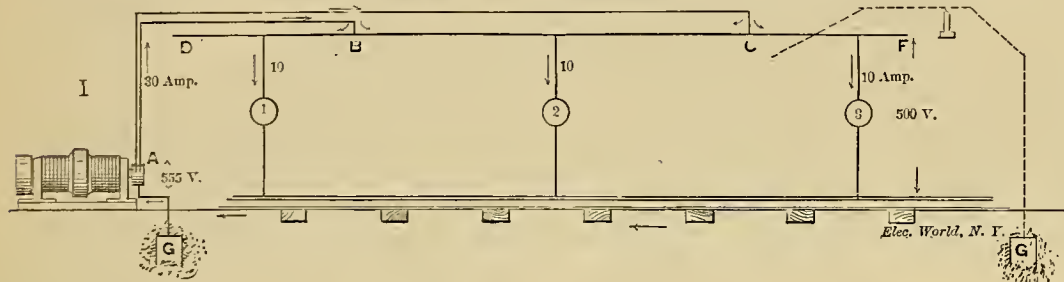

Fig. 3 forms a valve for the escape of water and for relieving over-pressure in the cylinders. It does not rest on the valve, but is supported by the two scraping shoulders on each side of the valve.

The lubrication of this engine has been made as nearly perfect as possible. Every oil cup is stationary, with slight feed and adjustable cut-off.

An independent pump and condenser, or a power condenser connecting direct with the engine shaft, can be used if required.

The compactness, smooth running and thorough economy of this engine should commend it to the attention of electric railway and lighting companies. Being of few and simple parts, it is durable and easily managed. Hitherto it has been used almost wholly for electric light plants, the demand in that field being so great, but its points of superiority make it also highly desirable for general use in electric railway power houses, etc.

If a telephone, or other wire, with a ground circuit, comes in contact with any portion of the overhead conductor, current will flow from the power circuit through the telephone circuit in amount depending upon the resistance of such wire between the point of contact and its earth

there is no effect. If the wire falls across the two railroad wires, the dynamo is short circuited, and either such intruding wire is burned apart or the safety device of the dynamo opens the circuit.

Fig. 4 shows the series system. If any live wire, that is, any wire through which current is passing, or is in electrical connection with the dynamo, breaks, the dynamo line is opened, and the dynamo ceases to generate current. If a telephone wire drops on one wire, nothing results; if on two adjacent wires, nothing occurs until a car reaches such section; then the motor is short circuited, and, being robbed of its current, stops until the obstruction is removed. If two grounds, such as at X and Y, occur, no effect is produced, with the exception that the telephone subscribers would be connected without permission of the telephone company, until a car reached one of the sections between such grounds as at Z X, and then a difference of potential would exist between the telephone or

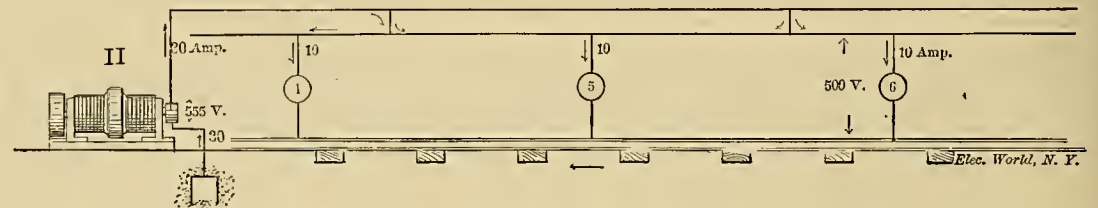

connection. If a telephone be in such circuit it will be burned unless a safety device be arranged to protect the same.

In Fig. 2 we see a modification of the above system. A main wire is erected parallel to the trolley wire, and into this main a number of

other wires, in amount depending upon the work being done by the motors between the same. They might, or might not, be burned, depending upon the difference of potential thus set up and the sum of the resistances of the intruding wires.

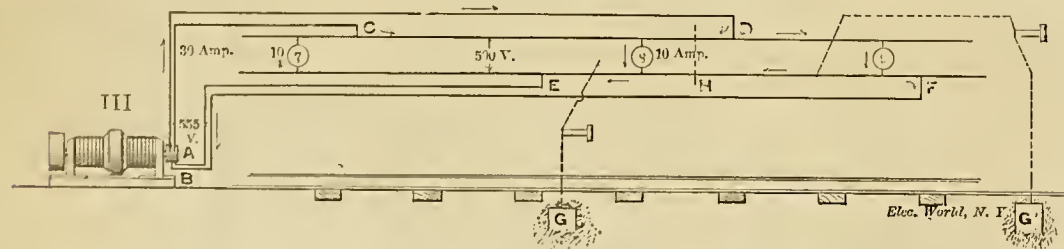

These engines are built 50, 75 and 100 horse power. For larger sizes a different form of bed is used—a bed that is lower and heavier, while the governor is placed in a separate case outside the disk.

### E. P. Roberts on Electric Traction.†

In an excellent paper on the above subject, read by Mr. E. P. Roberts before the Altoona Mechanics' Institute, the author gave a number of valuable details on the operation of the general types of electric railways now in use. Referring to the methods adapted for feeding the line, the author described several plans which have been adopted, as follows:

In Fig. 1 we see a diagrammatic representation of an overhead single conductor D F with wires A B and A C connecting the same with the dynamo. In this case the rails are all connected to a large copper wire leading back to a good

feeders supply current at different points in order that all parts of the system shall have, as nearly as possible, the same electrical pressure. The main wire is connected to the trolley wire at a number of points. The same observations as

### J. A. Rhomberg's Big Scheme.

Mr. J. A. Rhomberg, president of the Dubuque Street Ry. Co., was in Chicago last week. He has a mammoth scheme on his hands: He recently bought what is known as Thompson's Mill on the Maquoketa River, together with six or seven hundred acres of land lying northwest of the mill. The land which Mr. Rhomberg has purchased what was once the bed of a great lake, and it is his intention to make a lake of it again. This he will do by restoring the dam two hundred feet wide which formerly existed at the mill. This will make a lake one and one-quarter miles in length, with a maximum width of three-eighths of a mile and about thirty feet of water.

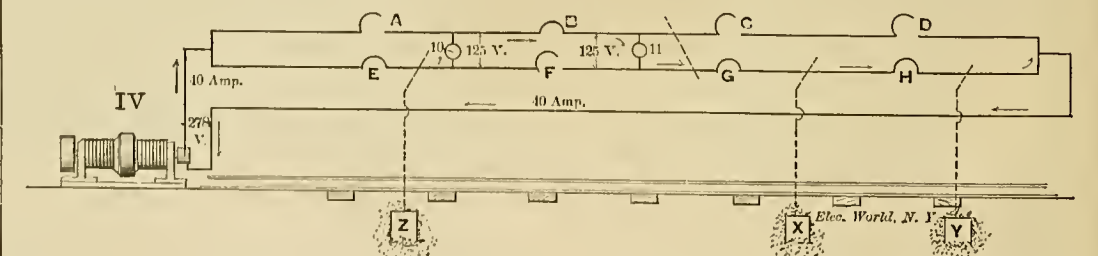

to breaks and grounds hold good for this case as in case one.

In Fig. 3 two overhead wires are used, and the current going out in one, returns through the other, no ground connections being used. If a distributing wire breaks, no injury to the oper-

Mr. Rhomberg's idea is to utilize water power for his projected electric railway, which latter will be extended along the line of his possessions, in the most attractive part of which he proposes to build a magnificent hotel. The enterprise will cost something like \$200,000.

\* John T. Noye Mfg. Co., Buffalo, N. Y. Courtesy of Am. Engineer  
† By courtesy of Electrical World.



**Wright Electrical Engineering Co.**

FIRST ANNUAL DINNER.

The first annual dinner of this enterprising company was held at the American House on New Year's Day, Mr. Frank Ridlon, being at the head of the table while Mr. Alex. P. Wright took the other end: the menu was a unique affair, having its front page decorated with a design peculiar to the science of electricity, etc. About 30 gentlemen sat down to dinner, including all the officers, etc., of the company. The menu was as follows:

**MENU, A LA CONTRACT.  
CLOSED CIRCUIT.**

- SOUP.
- "Incandescent."
- Julienne, "Fused." Tomato, "Double Pole."
- FISH.
- "Hauled."
- Cusk, a La Creme, "Poled."
- REMOVES.
- "Insulated."
- Boiled Philadelphia Capon, "Trimmed."
- Roast Sirloin of Beef, "Shaved."
- Saddle of Mutton, "Gained."
- ENTREES.
- "Shunted."
- Oyster Patties, "Fished."
- Vol au Vent of Kidneys, "Cut Out."
- Baked Macaroni, "O. K."
- Apple Fritters, "Cored."
- Mayonaise of Chicken, "Guyed."
- Lobster Salad, "1000 Volts."
- SWEETS.
- "Alternating."
- Charlotte Russe, "500 Amperes."
- Blanc Mange, "All Wright."
- Wine Jelly, "Sec'y."
- Assorted Cake, "Binding (Post)."
- DESSERT.
- "Transformed."
- Oranges, "100 Ohms." Bananas, "Wasted Lines of Force."
- Apples, "Brushed." Grapes, "Primary."
- Frozen Pudding, "Saturated." Sherbet, "Excited."
- Coffee, "High Tension."
- Benediction by Rev. Father McGlynn, by Special Request.*

**OPEN CIRCUIT.**

A number of facetious dispatches were received and read, and the party was one of the merriest that ever congregated at the old hostelry.

**The Kryger Snow Shovel for Electric Railways.**

It is stated, says *Practical Electricity*, that this machine will cut snow from 16 to 30 feet in depth, and, further, that the difficulty of choking off the air from the fan, thereby preventing the throwing of the snow, which has been encountered with other devices, is entirely overcome in the Kryger by elevating the snow into a fan, leaving sufficient space so that it can not choke. The fan of the Kryger shovel will make 400 revolutions per minute; it is eight feet nine inches in diameter and, as is claimed, only one-fourth of the power necessary in other devices, is required for the same result.

A distinct peculiarity is shown in the "cutters" of the Kryger. Instead of being round and thus cutting a round hole in the snow and leaving corners on each side of the rail, which the plow must push out by main strength, the Kryger shovel cuts a hole through the snow and ice 8 feet and 8 inches wide across the rails below and 10 feet 8 inches above. The knives have two motions, one from the car, and one from the elevator, and, in this double motion, there is claimed an increased gain of power; whereas in coming up squarely to a drift a great deal of power is needed to hold the plow up to the snow. In this type the elevators and cutters are run by a stationary engine in the car; but in the apparatus intended specially for street railways, they are operated by a stationary electric motor in the car.

In order to get the wheels down to the rails, flangers are pushed in front of the machine, operated by either the engine or the motor, and making 300 revolutions per minute.

This is the only revolving flanger in use, and one advantage is that it goes between frogs and switches and does not have to be raised to pass them. The front flanger will cut 4 inches across the rail on top and 2 inches on the inside of the rail and will cut solid ice. Each flanger is equipped with 12 steel knives which can be kept revolving at high speed, although the car itself may be retarded by the ice. The rear flanger

will cut solid ice and snow and throw it 20 feet on each side of the rail, cutting the full width between the rails and making 600 revolutions per minute. It has 6 steel knives, the full length of the cylinder, which is 20 inches in diameter, and is raised and lowered by the air when passing a switch.

The Kryger shovel is able to stop its elevator and fan and then to flange the track between the rails at the rate of 20 to 40 miles per hour. It can go through a snowdrift 16 feet deep and one mile long in 40 minutes and can throw the snow 300 feet on either side of the track and run the fan to the right or left.

The lightness of the Kryger machine is most remarkable—only 25 tons when built for steam roads.

We regret that, owing to the shortness of time,

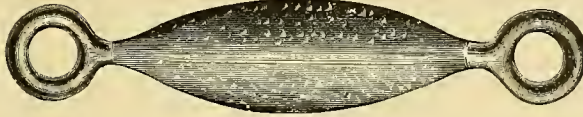

CENTER CURVE INSULATOR.

it was not possible to give an illustration of the type of machine which the inventor has planned for use on street railways, where electricity is employed for motive power. The principles of construction and of operation are the same in both types, but in the electric snow shovel the details are much more simplified, much indeed is omitted altogether, and the weight of the whole apparatus greatly diminished. It is needless to add that the cost is much less.

The Kryger snow shovel is attracting the attention of steam railway men on account of the many practical advantages which it offers. Now that the inventor has adapted it to street railway necessities, it will certainly command similar attention from the managements of such roads throughout the country. Thus far this season, the electric railways have not suffered much from snow and ice; but the possibility of such an emergency is always present, and the best way to meet it is to prepare for it beforehand.

**The Scientific Grinding Mill.\***

We publish a cut of the "Scientific" Grinding Mill, showing an interior view from which a good idea can be gained of its general construction and the manner in which the work is done, grinding all kinds of grain. The double breakers for crushing ear corn are plainly shown, as is also

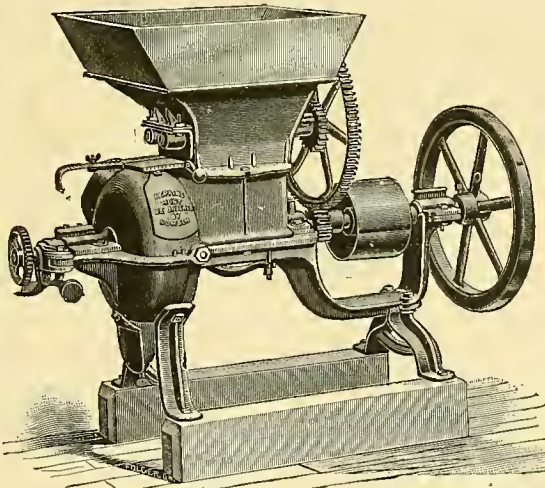

THE SCIENTIFIC GRINDING MILL.

the crusher and conveyor on main shaft, which crushes broken pieces from the double breaker and at the same time conveys them to the grinding plates, which have a peculiar dress and are remarkable for their strength and durability, and in this respect the manufacturers claim are greatly superior to plates in any other similar mill. This arrangement of double breaker crushing conveyor and grinding plates make it possible for this mill to grind all kinds of grain. We have seen it at work at fairs this season, when the operator would commence by grinding shelled corn; first fine enough for meal, then coarser for feed; then oats and shelled corn mixed; then oats alone; then he would throw ear corn into the hopper and it would go through in good shape;

\*The Foss M'fg. Co., Springfield, O.

then he would put oats and ear corn into mill at same time; then sheaf oats and ear corn together; then ear corn with shucks on; and end up with grinding corn stalks; the mill easily and successfully handling all of these grains and grinding fine or coarse as the operator desired. The cut also shows one end of the lever which holds the safety bottom in place. This device is to prevent accident in case iron or other foreign substance should get into mill; and as it works automatically, without any assistance from the operator, it is entirely practical. The manufacturers of this mill claim it is superior at every point, all of which can be easily proved, but there are three points, covered in this article, to which they would call the especial attention of interested persons:

First.—Durability of grinding plates. This is most important, because light cheap grinding plates wear out rapidly, and make the expense in operating a burden to the owner.

Second.—Ability to successfully grind all kinds of grain and do the work in superior manner, changing from one kind of grain to the other without any change in mill, grinding fine or coarse at will of operator.

Third.—Safety devices which act automatically to prevent breakage in case iron or other foreign substance accidentally get into the mill.

**Centre Curve Insulator.\***

The necessity for high insulation and reliable devices in the construction of overhead electric railways, is apparent to those interested in their construction, and no little thought has been devoted to the improvement of each device used in the system. The centre curve insulator which we now illustrate, is valuable in this connection, inasmuch as the curves are frequently subjected to enormous strains, hence it becomes necessary, where the wires are brought to a common focus, that the insulator should be strong enough to resist any strain that may be brought to bear upon it, and at the same time to retain the proper degree of high insulation.

We believe that such results have been accomplished in the subject of illustration. This centre curve insulator is made of an insulated compound with welded eye bolts, which, when in use, is subjected to a compression strain, and for this reason is, under ordinary usage, impossible to pull apart.

**Quick Work.**

WONDERFUL ACHIEVEMENT OF BRODERICK AND BASCOM ROPE CO.

On December 27th at 5:30 o'clock p. m. Judge Thayer, of the U. S. Circuit Court, issued an order to the receiver of the St. Louis Cable & Western Railway Co., to purchase from the Broderick & Bascom Rope Co. a cable 27,000 feet long, with the understanding that said cable would be delivered within 24 hours.

As the traffic was entirely stopped, and the road could not be operated till the new cable was furnished, the manufacturers in order to have the rope delivered within the time specified, were compelled to unload a cable weighing over 70,000 lbs. and then load this cable on the same car. A special engine was engaged and the rope hauled 28 miles, and then loaded onto a wagon and hauled through the streets of St. Louis a distance of a mile and a half, and delivered at the power house of the cable road before 6 o'clock the following day. The actual time was a few minutes over 24 hours.

To give our readers an idea of the magnitude of this transaction, we would state that the cable was 27,000 feet long, 1 and 5-16 inches in diameter and weighed 76,000 lbs.

The Walker Manufacturing Company has been awarded the contract for Cable Winding Machinery for a plant to be built in Portland, Oregon, by the Pacific Cable Construction Co., of San Francisco, Cal. This plant will be driven by cotton ropes instead of gears.

Messrs. H. Mc. L. Harding, of the Sprague Co. of N. Y., E. H. Johnson, ex-president of the same company, and J. L. Barclay, of the Sprague Electric Equipment Co., Chicago, left for New York January 15.

\*Sprague Electric Equipment Co., Chicago.



# The Street Railway Gazette.

S. L. K. MONROE, - - - - - MANAGER.  
E. V. CAVELL, - - - - - EDITOR.  
EDWARD J. LAWLESS, - - - - - ASSOCIATE EDITOR.  
W. L. S. BAYLEY, - - - - - MECHANICAL EXPERT.

## GENERAL OFFICES:

### CHICAGO:

8 LAKESIDE BUILDING.

AGENCIES } San Francisco, - - - 1222 Bush Street.  
{ Toronto (Canada), - - - 53 Magill Street.  
Cable Address=TRAM. CHICAGO.

Annual Subscription (Including Postage).	Per Copy
United States, Canada .....	\$2.00. .... 25c.
Great Britain, Ireland, India, Australia 10s. ....	1s. ....
Germany .....	9mk. 75 pf. .... 89pf.
France, Belgium, Switzerland .....	2fr. 95c. .... Fr 1.10.
Spain .....	21ps. 95c. .... Ps 1.10.
Austria, Holland .....	6fl. 74c. .... 55c.
Italy .....	12 lire. .... 1½ lra.
Venezuela .....	12 boliv. .... 1½ bol.
Mexico .....	\$3.00. .... 30c.
Annual Subscriptions in Argentine Republic, 2½ peso; Brazil, milre; Turkey, 54 plasters.	

[Entered at the Chicago post-office as second-class matter.]

\* \*

Matter for publication should reach the Chicago Office not later than the last day of each month. All communications should be addressed, THE STREET RAILWAY GAZETTE, Chicago, Ill.

## Important Announcement.

Mr. W. L. Allen, Secretary of the Western Electric Railway Association, requests us to announce that the first annual convention of that body will be held at the Grand Pacific Hotel, Chicago, on Wednesday, January 29, 1890, at 10 a. m., and not in Des Moines, as previously arranged.

## Reprehensible Journalism.

In its last two or three issues, the GAZETTE has taken occasion to call attention to the utter unreliability of technical news pertaining to street railways, published in the great dailies. Here we read a sensational account of the tragic death of a colored boy at Chattanooga, caused, it was solemnly stated, by "direct contact with the motor," or with the trolley wire. A prominent Chicago daily sprung this upon its long suffering readers. Investigation showed the tragedy to be the direct result of "colored somnolence," best explained in the following:

"Under this sod, so turfy,  
'Mid flowers and waving green  
Rests William Johnson Murphy  
As usual — Kerosene."

The fever then struck Denver with a force almost equal to that of the fashionable *La Grippe*, and a recent issue of one of its leading papers shows a diagram of what its brilliant editor evidently wishes to impress the public is the result of the introduction of electricity for the purpose of street car propulsion. This alleged work of art is quite a curiosity in its way, and worthy of a month's engagement in a dime museum. It is sub-divided into a number of spaces, each one of which is devoted to showing imaginary dangers to human and animal life from contact with the trolley wire. But we will not attempt to describe it in detail. The genius of the most brilliant Munchausen or Mulhatton, who ever breathed would be taxed to the utmost to do it justice — we give it up in despair.

Cleveland, O., next falls into line, with a hair-raising description of the death of a valuable horse from contact with the trolley wire. Investigation showed that the horse was knocked

on the head by its owner, with a billet of wood, and killed.

New York, not to be outdone (except in securing the World's Fair) now caps the climax of imbecility and utter ignorance of the subject by publishing the following evidence of being "in-briated with the exuberance of its own verbosity." "Suddenly, by reason of a slight catch of a trolley wheel on a point of the overhead wire, the latter falls on the car. \* \* \* The latter contains sixty or sixty-five passengers. \* \* \* A circuit is formed, and we all know what a shock of this kind means. You may picture the stiffened corpses that are removed through doors and windows."

Is it not time that a halt should be called upon this reckless publication of misleading statements? Let the daily press stand by the highest planks in its platform, and, while being a "moulder of public opinion," let it not forget that higher and more meritorious ambition to still be "an exponent of the truth."

In our December number we asserted that "no human life has ever been sacrificed by reason of contact with the trolley wire, when the voltage did not exceed 500," and we still adhere to that statement. Let those who doubt the veracity of our assertion disprove the statement by actual facts. The burden of proof is on them.

## No Time Like the Present.

A prominent eastern street car builder visiting the city this week, expressed the belief that at least twice the number of cars will be ordered by street railway companies this year, than is possible for the car builders to turn out. This conviction is also confirmed by the fact that the two principal electric railway machinery manufacturers have now orders on their books which will keep them fully up to their capacity until July or August, and that, within a month, they expect to have orders for at least three times what is possible for them to turn out during the year.

We should advise street railway companies intending purchasing equipment to get their orders placed at as early a date as possible, if they wish to secure the advantages and profits of summer business, not to speak of the corresponding increase in price that always arises when the demand exceeds the supply.

## Poor Construction.

The secretary of a street railway company in one of the larger cities, when discussing the merits or demerits of electricity as a motive power, made the following remark, which is worthy the consideration of managers of existing electric railways and those about to equip.

"Many of the troubles of different lines arises from the fact that *not enough attention is paid to the construction from the road bed to the overhead wiring.* The motto should be 'look out for mechanical trouble and leave the electrical portion to those who have given it years of study and thought.'"

Heartily endorsing the remarks of this gentleman, we submit the following advice:

Get your road bed in first class condition before you attempt to start your line.

Equip your power station only with first class machinery.

Let the weight of your rail be commensurate with that of the expected traffic—better err on the right side—a poor rail means replacing same after short service.

Put plenty of copper in your overhead line, and if the road does not work satisfactorily, it is because you have not adopted the proper electrical equipment.

## Richmond Road Controversy.

So much has been said regarding the alleged "failure" of the Richmond Union Passenger Railway, that, in common justice to those gentlemen who projected and carried out to completion an enterprise of — at that time — so much magnitude, we publish on another page a full statement from the company which equipped the road with electricity, and which has, ever since its completion, been compelled to have misleading statements banded about, to its detriment, regarding its responsibility in the alleged "failure" of the road.

That the building of the Richmond road was by far the largest kind of a similar enterprise that had then been attempted is a well known fact, and that such an enterprise could be brought, at once, to a state of absolute perfection, without mistakes being made, no one could reasonably expect, but, from the close investigation made by us into the facts, we do not hesitate to state that, in our opinion, the blame for the alleged "failure" has never yet been officially placed where it belongs.

Be that as it may, it certainly appears to us, that had it not been for the nerve, fearlessness and enterprise exhibited, by the concern which furnished the equipment for the Richmond road, electric street railway interests would certainly not yet have attained the magnitude or importance that they have to-day.

## No Danger in the Trolley Wire.

At the inauguration dinner of the Boston Electric Club, Mr. Geo. W. Mansfield said regarding the trolley wire:

"One or two matters have been alluded to this evening which I think ought to be emphasized, and one is that our club should become a great public educator on electrical questions. I think we ought all to feel that we have a mission of almost more importance than any other science in existence. Public interest in steam and other similar matters is old, but the interest taken by the public in electricity and the men who are engaged in handling electric matters, is on the increase, and the people now come to us for their information on these subjects; and to keep abreast of the times, men must know something about electricity. Our legislators and others in authority must come to our Electric Club and associate with the members, and I feel that every member of the club ought to recognize the fact that almost every word he utters, every act he commits in the prosecution of his work should be chronicled by the historian of the club and subsequently presented to the public. By such means the people would become educated and enlightened. A short time ago a little incident occurred in connection with my little single trolley wire, which interested me a good deal. I had to attend an enquiry that was being held, and of course I sung my prettiest little song to the gentlemen before whom I appeared, and very soon, as you may imagine, I convinced them all that there was nothing more harmless than a single trolley wire encircled by a 500 volt current. At that enquiry a gentleman who may have been well posted in telephonic matters, made some remark about a current of 10,000,000 ohms. Upon which a gentleman sitting by exclaimed, 'Good G-d! Mansfield, what would be the result if that 10,000,000 ohms fell on to a man?'

"Now, gentlemen, that is typical of the ignorance which prevails. So I feel and hope that with all the effort and interest and power that I can bring to bear upon members of this club this next year, I may be able to present many new facts and principles bearing upon our science, so that every man on the streets, every newsboy, if asked the question, can tell the difference between 10 or 200 volts or ohms, and that the children in our schools may learn something, and our legislators should have presented to them in a very pleasant manner, such as at a dinner like this, the same important facts."



## Legal Decisions.

## IN ALL COURTS OF LAST APPEAL.

RULE OF LAW AS TO PRECAUTIONS FOR SAFETY OF PASSENGERS.—*Watson vs. St. Paul City Railway Co.*, Supreme Court of Minnesota, November 18, 1889. 43 N. W. Rep. 904.

This was an action by George H. Watson to recover from defendant for injuries received by him while a passenger upon a car running upon the cable line of defendant. The plaintiff alleged that through the defendant's negligence in employing unskilled servants, and in not providing proper machinery and appliances, defendant's cable train became unmanageable while descending a steep hill, and ran with great speed to the foot of the grade, where the car in which plaintiff was riding was thrown from the track, causing the injuries complained of. Judgment for plaintiff and appeal by defendant. The court say: "The modification of defendant's tenth instruction was correct. The proposition of counsel was: 'The law does not require that such additional precautions as it is apparent after the accident might have prevented the same, should have been previously adopted, but only such as would be dictated by the care and prudence of a cautious and careful person before the accident, and without knowledge that it was about to occur.' The modification made was in respect to the degree of care requisite, and as to such precautions the court substituted for the last part of the request the words 'unless they are of such a character as should have been contemplated in the exercise of the greatest care and foresight.' The defendant is a carrier of passengers, and, as respects the construction and condition of its track and roadbed, as well as its cars and their management, the extreme rule as stated by the court is applicable generally, as in the case of other carriers. *Smith vs. Railroad Co.*, 32 Minn., 1, 18 N. W. Rep. 827." Affirmed.

CONTRIBUTORY NEGLIGENCE A JURY QUESTION.—*Howland vs. Union Street Railway Co.*; Supreme Judicial Court of Massachusetts, November 11, 1889. 22 N. E. Rep. 434.

Actions by Clarence E. Howland, a minor, who was run over by one of the Union Street Railway Company's cars, for personal injuries; and by Humphrey D. Howland, the father, for the loss of the minor's services, and the expense, care and trouble incident to the injury. The verdict was for plaintiff in each case. The court refused to instruct that the jury should find for the defendant, and the defendant excepted. The court say: "We think the plaintiffs were entitled to have their cases submitted to the jury. The boy was in the street for a legitimate and proper purpose. The evidence would have warranted the jury in finding that he had walked upon the street railway track for not more than 80 or 90 feet, by the side of a noisy ice cart, which might prevent him from hearing a street car approaching from behind; that if, at the time of being run over, he was standing still, as he himself testified, this had been but for a moment, while, if the driver was correct, the boy was yet walking along; that the driver of the street car was careless; that the boy might properly rely somewhat on the driver's using greater care than he did use; and that there was no reason to expect a car along at that particular time, the car being five or ten minutes late, and another not yet due. With evidence tending to show the state of things, it was for the jury to say whether, on the whole, the boy exercised such care as he was bound to exercise." Affirmed.

LICENSE FEE IN NEW YORK CITY.—*Mayor, etc., of New York vs. Third Avenue Railway Co.* Court of Appeals of New York, November 26, 1889. 22 N. E. Rep., 754.

Appeal by defendant from judgment for plaintiff, affirmed by general term of supreme court. This is a suit brought by the city to recover a license fee of \$20 per car from defendant, under the ordinance of 1852, entitled "of stages and accommodation coaches." The contention of the defendant is that the ordinance enumerates as its subjects "a stage," "an accommodation coach," "a stage coach," and is altogether silent as to "railroad car" or even "car."

The court say: "We are unable to see the force of the position of defendant. In definition, a 'car,' or 'coach,' or 'stage,' or 'stage-coach' is the same. They are vehicles that turn, or run by turning on wheels. It is plain that by adaptation and improvement the modern railway car has been evolved from the old-fashioned stage-coach. *The American Railway*, p. 231. We are therefore to look at the context of the resolution, and the circumstances under which it was adopted, and especially at the matter which the parties had in contemplation. 1. There was a grant by one party of a valuable franchise or privilege in conveying passengers along one of the avenues of the city. 2. Over that avenue there were at that time three stage lines, accommodating a large travel, and these paying for each stage or coach a license fee of \$20 to the city of New York. In the nature of things the new mode of transportation would succeed the old. Its purpose was the same. The railroad would drive off the stages, or, if travel sufficed, the new vehicle and the old would at least run in competition. If driven off the license fees would be lost to the city; and if both survived, there was no reason why one company should be favored and the other not, or the city be denied its revenue from either. In fact, with the competition of defendant's road, the stage lines were completely superseded. The receipt of revenue as part of the consideration of granting the new franchise was the object aimed at by the city, and its payment was part of the price agreed upon by the other party. Both then had a license fee in contemplation, and it is conceded that there was no other than that prescribed by the ordinance, *supra*, on which plaintiff now relies." Affirmed.

BONUS IN LIEU OF TAXATION.—*City of New Orleans vs. Crescent City Railway Co.*, Supreme Court of Louisiana, November 18, 1889. 41 La. Ann., 6 South. Rep., 718.

The city of New Orleans, by ordinance exempted the defendant from the payment of taxes, upon condition that it should pay into the city treasury a stipulated bonus. Upon the opinion of a city attorney subsequently rendered, that the city could not legally exempt the defendant from taxation, the company paid its regularly assessed taxes, instead of the bonus. This suit was thereafter brought to recover the bonuses. Judgment was for defendant and plaintiff appeals. The court say: "It would be tedious to enter into a recital of the lengthy, different ordinances passed, and contracts entered into, in relation to the rights and obligations of the respective parties. It is sufficient to state that it clearly appears from their spirit and tenor that the bonus was to be in place of taxes, and that all claim by the city to the bonus was relinquished on their paying their taxes. The evidence showing such payment, it follows that the claim for the bonus is without foundation, as the city can not have a standing claim to both. *New Orleans vs. Railroad Co.*, 23 La. Ann. 497; *New Orleans vs. Sugar-Shed Co.*, 35 La. Ann. 548; *New Orleans vs. Water Works Co.*, 36 La. Ann. 432; *Rev. Civil Code*, Art. 2031. The city can not collect both bonus and taxes. Having elected to collect the taxes, she can not now sue for the bonus. It has been so decided by this court. There can be no doubt that, as the city had no power to exempt from taxes, or agree legally to a commutation, the stipulation of exoneration was in contravention of law; but it does not follow therefore that the city must recover the bonus. The understanding was that the bonus should be paid, provided no taxes were demanded. If the condition on which the bonus was to be paid be prohibited, then it is void, and its nullity is destructive of the contract upon it." Affirmed.

A COMPANY MAY BY ORDINANCE BE REQUIRED TO PAVE OUTSIDE THE RAILS, THOUGH BY ITS CHARTER IT IS ONLY REQUIRED TO PAVE BETWEEN THEM.—*Sioux City Street Railway Co. vs. City of Sioux et al.*; Supreme Court of Iowa, October 9, 1889. 43 N. W. Rep. 224.

The charter of plaintiff required it to pave the space between its rails, and this action is brought to test the validity of a subsequent ordinance requiring it to pave one foot outside its

rails. The court say, on appeal from judgment for defendant:—"The claim of plaintiff is that the ordinance in question and the action of the city thereunder are in conflict with article 1, sec. 10, pl. 1, of the constitution of the United States, in that they have the effect to impair the obligation of a contract. The claim of plaintiff in support of this allegation is based upon the position that the requirement to build the pavement in question, and the assessment therefor, is a burden additional to those imposed by the statute and ordinance under which plaintiff built its street railway, which are recited in our former opinion in this case, 39 N. W. Rep. 498. The ordinance of the city, the plaintiff insists, was a contract under which plaintiff undertook to build the street railway upon the condition of paving between the rails, and doing other things which need not be specified. The paving outside of the track of the railway was not provided for by the ordinance, and is therefore a burden additional to those imposed by the ordinance granting plaintiff authority to build its railway. What was that contract? It was this: the city conferred upon plaintiff the authority to construct and operate a street railway, on condition, among others, that plaintiff should pave between its rails. The city contracts to secure to plaintiff its right to construct and operate the railway. The plaintiff contracts to pave between the rails. The city, by granting the authority to construct and operate the railway upon the condition of paving, did not limit its authority to make and enforce other regulations and requirements, as authorized by code, sec. 1090. The condition as to the paving is the obligation of plaintiff and not of the city. The contract between the plaintiff and the city, neither expressly nor by implication ties the hands of the city, and gives it over to plaintiff, without authority to make and enforce other regulations as to the construction of the pavements." Affirmed.

The decision rendered by Judge Shepard in the injunction suit between the West Side Street Railway Company and the Chicago City Railway Company, is as follows:—

"Assuming that the right, so far as the city can give it, to construct and operate a cable system in State street, has been conferred upon the West Side company by the ordinance empowering that company to cable its 'various lines of railway,' the exercise of that right is clearly subordinate to the rights of the South Side company in that street, if the use of a cable system by the former shall operate to exclude the latter company.

"The right of the West Side company upon State street is wholly dependent upon the contract and deed of 1863 between the two companies, and both those instruments expressly provide that the use of the State street tracks by the West Side company shall not unnecessarily interfere with the running of the cars of the South Side company.

"The arrangements made in subsequent years have been more matters of convenience, and conferred no new and no permanent rights as between the two companies, and have been merely such as were provided for in 1863 for the purpose of regulating the use of the tracks jointly.

"The contract of 1863 provides: That it (the West Division company), will at all times so regulate the running of its cars upon, and its use of said State street tracks as not unreasonably or unnecessarily to impair or interfere with the use and proper use of said last mentioned tracks by the said party of the first part (the South Side company).

"The pleadings and the proofs heard upon this motion are wholly upon the theory that the two westernmost tracks in State street can not be so cabled as to accommodate both companies, and that the cabling and operating of them by the West Side company will necessarily exclude the South Side company from their use.

"Upon that undisputed issue there can be only one proper order made, viz: That the motion to dissolve the injunction be overruled, and it is so ordered.

"With an issue presented by amended or additional pleadings, sustained by proof, that the two systems of cabling can be successfully accommodated in the three State street tracks, it would seem as if the private rights of the two companies could be made to conform to what appears to be a good deal of a public necessity—that the tracks on State street should continue to be the termini of both systems of railway under cable operation, as it has been under the old method of animal power.

"But so long as it is made to appear that only one cable system can be operated on State street, I must hold that the South Side company has the superior right there for that purpose."

## Patent Suit Decided.

An important patent suit that has been pending for some time, *Roberts vs. Foos Mfg. Co.*, of Springfield, Ohio, has been decided in favor of the latter. This declares Mr. Winchell, who is one of the firm of Foos Mfg. Co., to be the inventor of an initial breaking device on feed mills.



## STREET RAILWAY NEWS.

(See also "New Enterprises," "Extensions," "Elections," etc.)

(The following data is compiled with all possible care, but the publishers, receiving news as they do, from almost every state, territory and country, cannot be held responsible for errors, as it would be wholly impossible to obtain a verification of each item received by them in time for each issue.)

## DOMESTIC.

## CALIFORNIA.

**Santa Cruz**—The East Santa Cruz Street Ry. Co. has been incorporated with a capital stock of \$20,000, of which \$5,000 has been subscribed for.

## CONNECTICUT.

**New Haven**—It is very likely that the New Haven Horse Railroad company will adopt electricity in the spring.

## DISTRICT OF COLUMBIA.

**Washington**—Mr. W. E. Baughton, who for eight years has held the position of secretary and treasurer of the Belt Line Railway company, has resigned his position to accept one with the Johnson Co. of Johnstown, Pa. Mr. H. A. Haralson has been elected to succeed him.

## IOWA.

**Boone**—The street railroad company have petitioned the City Council for permission to operate its cars by electricity and to light the city by arc circuit.

## KANSAS.

**Atchison**—The Atchison Street Railroad system will be converted to the electric system in the immediate future: it has recently been purchased by a syndicate of Des Moines capitalists.

## MASSACHUSETTS.

**Boston**—At a recent meeting of the Newton Board of Aldermen the Newton Street Railway company was granted an extension of time until June 1st, 1890, to complete the construction and equipment of its electric railway.

**Gloucester**—The Gloucester Street Railway company has been granted permission to adopt the single trolley overhead system.

**Lowell**—The street railway companies here received permission to use the overhead trolley system or the storage battery on the Belvidere road, a distance of two miles on each line. In connection with this permission it is to be noted that the fire company are authorized to cut wires in case of need, and the company pledges itself to stop all electric currents in the case of being so requested by the fire department.

The company is placed under bond of \$10,000 to fulfill its contract with the city.

The grant is as follows:

Resolution authorizing and permitting the Lowell & Dracut Street Railway company to use electricity as a motive power.

Resolved by the Board of Aldermen of the city of Lowell assembled, as follows:

That the Lowell & Dracut Street Railway company be and hereby is authorized and permitted in addition to the rights now possessed by it, to establish, construct, maintain and use the single trolley electric system of motive power so called, or the storage battery so called, or both, in the operation of its cars and on certain streets, to wit:

Beginning at the junction of Merrimack, Bridge, Prescott and East Merrimack streets, on East Merrimack street to High street, on High street to Rogers street, and on Rogers street wherein and on which the tracks of said company are now located or may hereafter be located under location and extensions of its track heretofore granted to said company by the Board of Aldermen of said city, and to construct, lay, maintain and use the poles, wires and appliances and such electrical appliances and apparatus, to make the underground and surface alterations in and on said streets, ways and squares necessary for the purpose.

Provided, that the trolley wires shall, wherever they are crossed by an overhead wire owned by the city, said company or any other corporation or person, and whenever said Board of Aldermen may from time to time order, be suitably protected by a guard wire.

Provided further, that all feed wires shall be placed underground when said board shall order, and when grounded they shall be insulated in a manner satisfactory to such board.

Provided further, that in case the operation of the system shall in the opinion of said board impair the usefulness of the fire alarm system now in operation, or of any fire alarm, police or other electric system that the city may hereafter adopt, said company shall at its own expense and without delay, restore to its present efficiency the fire alarm system now in use and pay to the city hereafter any additional expense it may be put to by reason of said trolley system in the construction of any electric system it may hereafter adopt.

Provided further, that the officers and members of the fire department may in the event of a fire, and whenever in connection therewith they deem it proper, cut the wires of said trolley system, and if so cut they shall be repaired at the expense of said company. In case of fire the company shall at the request of any of the engineers of said department discontinue any and all currents of electricity over its wires. If said wires of said trolley system shall become broken from any cause connected with work being performed by the city, or any of its officers or servants, they shall be repaired by the company at its expense.

Provided further, that said company shall before any work of construction in the streets is done, execute under seal a contract properly filed and deliver the same to the city.

This resolution shall be null and void unless the same shall be accepted by said Lowell & Dracut Street Railway company, and notice of said acceptance filed with the city clerk within 30 days from the passage hereof.

The amendments adopted provide that the words "two guard wires" shall be inserted wherever the words guard wires occur. Also that "all work of construction under the resolution and all kinds and quality of material used and the height of all poles erected shall be satisfactory to the board of aldermen when the work is done."

The resolution in regard to the Lowell horse railroad and the amendments was the same, except the locations; they being given the same privileges from Prescott street, through East Merrimack, Nesmith and Rogers streets to the city line. It is understood that their idea is to ultimately extend the track to Tewksbury.

**Milford**—It is very likely that the street railway will be built from this point to Hopedale in the near future.

## NEW JERSEY.

**Elizabeth**—A franchise has been granted to the Elizabeth and Newark horse railway company to lay its tracks on Tumbold street to the Singer works.

## NEW YORK.

**Albany**—At a recent meeting of the stockholders of the Albany railway it was decided to place a mortgage on the property for five hundred thousand dollars.

The bonds will be payable in gold in forty years, interest to be payable semi annually at a rate not to exceed five per cent. per annum, the whole to be secured by consolidated mortgage covering the incorporated property and franchises of the company.

We understand that out of this amount the sum of one hundred and fifty thousand dollars will be used to redeem the previous issue of bonds now due, while the balance will be applied to the equipping of the company's line with the overhead system.

The Thomson-Houston system will be used.

**Brooklyn**—The Brooklyn City Railway Co. has requested permission to use electric cars on its Third Avenue line.

We understand that the Brooklyn and Coney Island Ry. Co. proposes to introduce the Thomson-Houston overhead system on the Jay and Smith Streets road, and extend the same as far as Coney Island.

**Buffalo**—We understand that the State Railroad Commissioners of Albany, having re-heard the application of the Buffalo Street Ry. Co. for permission to adopt the overhead system on its Forest Avenue line and said company having obtained the consent of the majority of property owners along the line, has granted the permission prayed for.

**New Rochelle**—The New Rochelle and Pellham horse railway company was given into the hands of a receiver on account of a mortgage for \$75,000 held by the Farmer's Loan and Trust Co.

Mr. Charles Strauss has been appointed by the Supreme Court as receiver.

**New York City**—The New York City Suburban Surface Ry. Co. has been incorporated with a capital stock of \$200,000 with permission to increase its capital stock, if necessary to one million.

The storage battery will probably be adopted.

Permission has been granted the Metropolitan Crosstown Ry. Co. to lay tracks across town from Grand Street Ferry on the East side to 14th street through on the West side.

A Third Avenue railway company has paid the sum of \$125,811.66 to controller Meyers in settlement of an old litigation concerning car license fees.

**Syracuse**—An effort is on foot to consolidate all street railway interests here, and adopt electricity as motive power. We understand that Mr. F. C. Eddy of the bank of Syracuse and Mr. Theodore Pool of Syracuse are interested.

## OHIO.

**Cincinnati**—The Short Electric Ry. Co. has secured the contract for the equipment of two divisions of the South Covington and Cincinnati St. Ry. The Short double overhead wire parallel system will be used. Twenty cars will be in service on the two lines and it is expected that they will be in operation in a few weeks.

**Columbus**—The following is an abstract of an ordinance recently passed in favor of the Rapid Transit Street Railway company in this city:

The Rapid Transit Street Railway company is to construct, operate and maintain a street railroad on Jaeger, Reinhard, Mohawk, Livingston avenue, Mound, Fourth, Chestnut, Buckeye, Lazelle, Summit, Ninth avenue from Hanford street to north corporation line of the city. Section 2 authorizes the company to lay down a single track with switches or turn-outs wherever necessary or convenient, or a double track, as the company may elect, and to connect the track or tracks by curves with the present tracks on High street.

The tracks shall be of standard gauge, five feet two inches, and the rails used shall be of an improved pattern, of not less than thirty pounds per yard. The space between the inner rails of the tracks shall not exceed three feet five inches.

The road shall be constructed and in operation within one year from the date of the completion of the Buckeye bridge and the approaches thereto. The company shall keep in repair all that portion of the street included within one foot on the outside of the outer rails of the tracks, and on order of the city council the streets shall be improved with the same kind of materials as other portions of the street. The pavements shall be laid at the height or grade fixed by the city civil engineer, and shall be kept in repair under this officer's direction; and on failure for thirty days, the work shall be done by the city and the costs collected from the railway company, which shall constitute a lien upon the property and franchises.

The railway company shall indemnify the city from all damages, lawful claims and demands for injuries to persons or property, costs and expenses to which the city may be subjected by this grant. The city of Columbus shall not be liable in any way to the company for losses sustained by the breaking or overflow of water from any sewer or drain, water pipes or gas pipes or by reason of any change in the grade of streets. The city is authorized to remove or obstruct any portion of the track whenever it is necessary to repair or lay down water pipes, gas pipes, sewers, drain, gutters or cisterns or for any other public work or improvement, not disturbing the running of cars when it can be avoided without incurring any liability for damages. In case it becomes necessary to remove snow from the track it shall not be left in such a manner as to interfere with or impede travel or render the street dangerous.

The conductors and drivers of cars shall not allow ladies or children to enter or leave any car while in motion, shall keep vigilant watch for teams, carriages, persons and obstructions upon the track, and upon the appearance of danger shall give warning and stop the car if necessary to prevent accident, and either the driver or conductor shall be on the front platform while the car is in motion.

No car shall be run at a greater rate of speed than ten miles per hour. Cars driven in the same direction shall not approach nearer than 100 feet unless from unavoidable necessity or on switches or turnouts. The company shall comply with such rules as are made from time to time by the city council as to the rate of speed it may run cars, and while the cars are in motion or about to start, warning shall be given by bell or otherwise to notify persons of approaching danger.

No motive power shall be used for propelling cars, except cable, electric, gas, horse and mules, except by the consent of the city council. Permission is hereby given the company to operate its line of street railway, with any and all extensions that may hereafter be made by horses and mules, and by cable, electricity or gas as a motive power as shall be acceptable to the city council, and the company shall have the right to erect and maintain poles, wires, fixtures or conduits or other appliances that in the opinion of the city council shall be found necessary. At and after dark, all cars, while running, shall be provided with suitable signal lights. No car shall be allowed to remain standing upon the line of route for passengers or any other purpose so as to impede any other vehicle, but shall be subject to such police regulations as are or may be prescribed to other vehicles, so far as they may be applicable. No car or cars shall be used if worn out, broken, or so constructed as to imperil the lives, limbs or health of the passengers.

In the erection of poles and the placing of wires or conduits or other appliances the plans shall be submitted to the council for approval.

Cars shall be run at intervals of not less than twenty minutes, unless prevented by unavoidable casualty, for at least twelve hours each day. Tickets shall be sold as follows: No charge shall be made for children under seven years of age attended by their parents; single fares five cents; tickets in packages of six, 25 cents; twenty-five tickets, \$1; one hundred tickets, \$4. They shall be on sale at their office and by conductors and drivers. The grant is to continue for twenty five years. The ordinance takes effect from and after its passage.

## PENNSYLVANIA.

**Beaver Falls**—The Beaver Falls and Metamora electric street railway and the new Brighton electric street railway have been incorporated. (See also extensions.)

**Chester**—Pres. E. Mitchell Cornell of the Chester street railway gave the employees of his



railroad a turkey feed on December 26th, which was quite a success and heartily appreciated by the men. A set of carriage harness was given to Supt. McFayden by the stable employes.

**Harrisburg**—The East Harrisburg Passenger Railway Co. has increased its capital stock from one hundred thousand to one hundred and fifty thousand dollars. (See extensions.)

**Lancaster**—The Lancaster City and East End Street Ry. Co. has received permission from the council to introduce electricity as motive power, upon the following terms and conditions:

*Resolved*, That for the purpose of introducing electricity as the motive power of the Lancaster City and East End Street Railway companies, Sumner T. Danham, his associates and assigns shall have the right to operate motor street cars and erect and maintain poles on both sides of each street along the route of said railway and at such points as the engineer in charge of the construction of said street railways may deem necessary to connect the poles on opposite sides of the street, so as to carry the wires which conduct the electric current to the cars.

Provided, that said wires shall be maintained at the height of not less than 18 feet above the grade or surface of the street or streets and all of the work in locating and erecting said poles and wires shall be subject to the approval of the street committee of city councils.

Provided further, that the city shall have the right to use said poles to support and carry any city wires as the city may now or hereafter may desire to operate, said wires to be erected so as not to interfere with the operation of said street railways, and

Provided further, that if any poles should be necessary in Penn Square, the same to be of iron pipe, properly insulated, of light construction, all other poles to be of wood, uniform in height and thickness as near as possible, and painted of a color approved by the street committee of city councils, and

Provided further, that the privileges herein granted shall be subject to all the rules and regulations pertaining to street railways now in force, and

Provided further, that the work of construction shall not be commenced until 30 days after the passage of this resolution.

The following is a gist of the report of the Committee of Councils which recently visited Easton for the purpose of investigating the Daft system of electric railways:

The Committee of Councils having visited Easton December 10, and having devoted an almost entire day to the inspection and investigation of the Daft system of electric railway in operation in that city, would unanimously represent that after a full and careful examination of the line and interviews with numerous citizens, they have reached the conclusion that the system is a success, and far superior to the horse car system now in use in Lancaster, for the following reasons:

First, Much better time is made between points of departure and destination. The cars, while running much more rapidly, have no more unpleasant motion than the ordinary horse car, and the noise is no greater than that made by the cars now in use here.

Second, That the committee failed to learn that the erection of poles and the suspension of wires are in any sense more dangerous or more objectionable to the Easton public than are the average poles and wires on the streets of this city.

Third, That the danger to persons from the wires, and accidents by reason of horses becoming frightened at the cars, were much less frequent than the committee had been led to believe.

Fourth, That the cars ascended and descended with ease and rapidity grades much steeper than any to be found within the limits of our city. Indeed, it appeared to be the general opinion among the people of Easton that the advantages of the electric railway over the horse car system more than counterbalanced any disadvantages resulting from poles and overhead wires.

Interviews with many persons developed the fact that while at first a large number of people were opposed to the electric system, almost all opposition to it has been removed, by reason of its many advantages over the old system of horse cars.

**VIRGINIA.**

**Staunton**—The Messrs. Adams of Arkansas have received a franchise to build a street railway in this city, provisional upon work being commenced not later than April first, this year, and completed in 12 months. The motive power will be electricity.

**WASHINGTON TERRITORY.**

**Tacoma**—At a recent meeting of the stockholders of the Point Defiance Railway company the contract for the construction of the line was awarded to Allen C. Mason of Tacoma. The line is to be completed by March. It will be six miles long and will be operated by electricity with the River and Rail system of storage batteries. Four cars will be used immediately on the completion of the line at fifteen or twenty men headway.

For news regarding Foreign Tramways, see pages 12, 13 and 14 of this issue.

**NEW ENTERPRISES.**

**CALIFORNIA.**

**San Jose**—A franchise has been granted to the San Jose and Santa Clara Railway company, the substance of which is as follows:

A double track railway on Santa Clara street for thirty-five years, the motive power to be electricity, applied by the most perfect systems of conductors and motors, the same to be approved by the Mayor and Common Council. The wires shall be supported, if by side poles, at a height of twenty feet, at intervals of not less than 120 feet, except at curves and street crossings. If center poles be used, the wires shall be suspended from iron cross arms attached to iron poles in the center of the street. Each pole shall be surmounted with an electric light of not less than sixteen candle power and shall be kept illuminated at the expense of the grantees, on each night from 6 o'clock to 11 o'clock, except when the moon is actually shining. The side pole system is adopted, the Council reserving the right to change to the center pole method whenever the public convenience may require.

The fare from any point to San Jose to University street shall not exceed five cents; to any point in Santa Clara, ten cents.

The cars must be provided with improved guards and fenders reaching within four inches of the roadbed to prevent accidents. Each car shall be lighted by electricity.

Upon acceptance of the ordinance the grantees abandon all rights to operate a horse railway on Santa Clara street. Permission is given the Ninth street and Stockton avenue horse-car line to pass over and along Santa Clara street for eight months from passage.

Should any unavoidable accident happen the electric system or should operation be suspended by order of court, the grantees may move their cars by horses during such temporary emergency. The electric railway shall be in successful operation to the satisfaction of the Mayor and Council within four months from passage. If the system shall not operate successfully, the Council may order substituted some other successful system. If the grantees refuse to do so, the railway may be removed from the street at the expense of the grantees and all rights shall be forfeited.

**ILLINOIS.**

**Chicago**—The Storage Battery Motor Co., of Chicago, has been incorporated with a capital of \$2,000,000, for the purpose of manufacturing and selling storage batteries, motors and street railway equipments. The incorporators are F. B. Hinckley, J. C. Halton and H. F. West.

**Streator**—We understand that a franchise has been granted to Pinckney F. Barr for the construction and operation of a street railway here; Mr. Barr having permission to adopt any motive power that he sees fit, but he allows it to be understood that electricity will probably be tried first. Four miles of the line must be constructed within a year.

**INDIANA.**

**La Porte**—A franchise has been granted for the building of an electric street railway here.

**IOWA.**

**Davenport**—The Davenport Electric Street Railway Co. will be in operation in May, and will be operated in connection with the Davenport Central Railway company, both from the same power house. The road will be four miles in length and will run six cars.

**MAINE.**

**Rockland**—Col. F. W. Dana, of Lewis, is considering the advisability of constructing a street railway here.

**MASSACHUSETTS.**

**Braintree**—The Braintree Street Railway has been incorporated with a capital of \$25,000, to build a line about seven miles long. We understand that the line will be operated by electricity. A list of the directors will be found under the head of Elections in this issue.

**Greenfield**—The Greenfield and Turners Falls Street Railway Co. has been incorporated with a capital stock of \$30,000, to build a street railway, and work will be commenced in the immediate future.

**Hingham**—A company has been found to be known as the Weymouth and Hingham Street Ry. Co. The capital stock is \$100,000. The road will be seventeen miles long.

**Springfield**—The street railway company here has received permission from the common council to use the trolley overhead system from the corner of Main and State streets through Main and Locust to Mill, through Ft. Pleasant and Sumner avenues to the end, the terminus opposite the City Park. The following is a transcript of the grant:

Ordered: That permission be, and the same is hereby granted to the Springfield Street Railway company to construct, maintain and operate the overhead, single trolley

electric system of motive power, so called, in the operation of its cars on the tracks extending southerly from the junction of Main and State streets, through Main and Locust streets to Mill street, and in the operation of its cars on the tracks, that it shall lay, under the authority this day granted, from the present terminus at said Mill street, across said Mill street and through Forest, Pleasant and Sumner avenues to the terminus opposite Forest park, and to exercise such powers, rights and privileges and erect such poles and wires in said streets and avenues as may be necessary and incidental to the proper enjoyment of the privilege herein granted. The aforesaid permission is, however, granted on the following express conditions, a violation of any of which shall, at the election of the board of mayor and aldermen, operate as a forfeiture of the permission and rights herein given, to-wit:

*First*, that all work of construction and all kind and quality of material used, and the height of all poles and wires erected, shall be satisfactory to the board of supervisors of highways and bridges, and that the system shall be kept in repair and cared for to the satisfaction of said board.

*Second*, that all poles shall be cylindrical in shape and painted black, and shall be removed, or their location changed, without expense to the city, within 60 days after such removal or change in location shall be directed by the vote of the board of aldermen.

*Third*, that no poles shall be erected until a plan, showing the location of the same, and duly certified by said company, has first been filed in the office of the city clerk, and the locations thereof approved in writing by said board of supervisors.

*Fourth*, that the trolley wires shall, wherever they are crossed by an overhead wire, owned by the city, said company, or any corporation or person, and wherever the said supervisors may from time to time order, be suitably protected by a guard wire.

*Fifth*, that all feed wires shall be placed under ground whenever said board of supervisors shall order, and when grounded they shall be insulated in a manner satisfactory to such board.

*Sixth*, that in case the operation of the system shall, in the opinion of said board of supervisors, impair the usefulness of the fire alarm system now in operation or of any fire alarm, police or other electric system that the city may hereafter adopt, said company shall at its own expense and without delay restore to its present efficiency the fire alarm system now in use, and pay to the city hereafter any additional expense it may be put to by reason of said trolley system in the construction of any electric system it may hereafter adopt.

*Seventh*, that the officers and members of the fire department may, in the event of a fire and wherever in connection therewith they deem it proper, cut the wires of said trolley system, and if so cut, they shall be repaired at the expense of said company. In case of fire the company shall, on request of any of the engineers of said department, discontinue any and all currents of electricity over its wires. If said wires of said trolley system shall become broken from any cause connected with work being performed by the city or any of its officers or servants, they shall be repaired by the company at its expense.

*Eighth*, that said electric car propelled along on said tracks by said system, and each train of more than one car, shall be provided with a conductor in addition to the driver or person in charge of the management of the car or train.

*Ninth*, that said company shall, before any work of construction in the streets is done, execute under seal a contract properly filled and deliver the same to the city.

**Townsend**—Surveys are under way for an electric railway from this point to Brookline.

**MICHIGAN.**

**Ludington**—A franchise has been granted for a street railway here; electricity will probably be the motive power.

**MISSOURI.**

**St. Louis**—The Electric Railway Construction company, capitalized at \$5,000, has been incorporated by C. C. Carroll, G. R. Powell, and J. P. Lawson.

**NEBRASKA.**

**Beatrice**—A franchise has been asked for by parties interested in the Wittenberg City Railway company.

**NEW HAMPSHIRE.**

**Concord**—At a special meeting of the stockholders of the Concord horse railway company, which was recently held here, it was decided to petition the city government for permission to use the overhead trolley system in lieu of horses, and it was voted to issue \$50,000 worth of bonds to cover the expense of changing to electric traction. The Thomson-Houston system will be adopted.

**Salmon Falls**—Permission has been accorded to the Berkeley Rapid Transit company to build an electric railway.

**NEW YORK.**

**New York City**—The New York City Suburban Surface Railroad company has been incorporated with a capital stock of \$500,000.

**Matteawan**—It is probable that an electric street railway will be built here in the near future.

**NORTH CAROLINA.**

**Winston**—An electric street railway is to be built here in the near future.



## OHIO.

**Harrison**—The Home Electric Ry. Co. has been incorporated with a capital stock of \$50,000.

**Marietta**—We understand that an electric railway will probably connect the towns of Columbia, Marietta and Maytown in the immediate future.

## OREGON.

**Corvallis**—The Corvallis St. Ry. Co., capitalized at \$50,000 has been incorporated. The incorporators are Zephian Job, J. H. Wilson and Ralston Cox.

**Eugene City**—An electric street railway project is under way here and will probably be put through during the winter.

**Jacksonville**—It is likely that an electric railway will be built from this point to Medford in the spring.

## PENNSYLVANIA.

**McKeesport**—A charter has been filed by the McKeesport and Duquesne Street Ry. Co. The capital stock is \$15,000 in three hundred shares of \$50 per share. A list of officers will be found under head of "Elections" in present issue.

**New Brighton**—The New Brighton Street Ry. Co. has been incorporated with a capital stock of \$35,000.

**Pittsburg**—The Suburban Rapid Transit Ry. (Electric) is to be run into this city.

The Pittsburg, Alleghany and Manchester Electric St. Ry. Co. of this city has been incorporated with a capital stock of \$50,000. A list of the directors will be found under the head of "Elections" in present issue.

## SOUTH CAROLINA.

**Charleston**—We understand that a scheme is on foot to build a dummy line from this point to Summerville. It is proposed to run the line through St. Andrews on the other side of the river using one of the bridges already built, or the bridge of St. Johns and Berkely when completed.

The scheme is on foot for the building of an electric railway from Greenville to the top of Paris mountain, seven miles distant from the city.

## VIRGINIA.

**Hampton**—The Hampton and Old Point Street Railway company recently met and decided to commence work of construction at once. Work when commenced will be pushed through to completion and it is expected that the contract will be awarded for the construction of the road at an early day.

## WASHINGTON TERRITORY.

**Seattle**—The West Seattle and North End Electric St. Ry. Co. will build along the water front. D. H. Gilman of Seattle is interested.

## ELECTIONS.

**Baltimore, Md.**—At a recent meeting of the stockholders of the Schuylkill East Side Railway Co. the following named gentlemen were elected as directors:

Geo. D. Kein, Thomas M. King, J. B. Washington, H. T. Douglass, J. VanSmith, J. Carroll Walsh and R. D. Ashurst.

**Braintree, Mass.**—The following is the list of the directors of the Braintree Street Railway company recently reorganized:

Hon. Francis A. Hubbard, Hon. James T. Stevens, Daniel Potter, Geo. D. Willis, Elisha Thayer, Henry M. White, Martin L. Tupper.

**Dubuque, Ia.**—The officers of the Dubuque Electric Railway, Light and Power company are:

President—W. L. Allen.  
Secretary and Treasurer—T. O. Swiney.  
Directors—W. L. Allen, T. O. Swiney, J. P. VanPatten, E. D. Allen.

**Greenfield, Mass.**—The following named gentlemen have been elected as directors of the Greenfield and Turners Falls Street Railway Co., recently chartered:

N. S. Butler, Frank O. Wells, F. E. Wells, and Levi J. Gunn, of Greenfield; Sumner Y. Dunham, Clark Bell and A. A. Sclove, of New York City.

**Hamilton, O.**—At a recent meeting of the Hamilton & Lindenwald Electric Transit Co., the following named gentlemen were elected as its officers:

President—Thomas Milikin.

Vice-President—C. Benninghofen.

Secretary—Ira T. Milikin.

Treasurer—P. Benninghofen.

**Lawrence, Mass.**—At a recent meeting of the stockholders of the Merrimack Valley Horse Railroad company the following gentlemen were elected:

President—Franklin Butler.

Vice-President—A. W. Stearns.

Treasurer—A. C. Butler.

Directors—A. W. Stearns, James F. Eaton, Fred. Butler, Byron Truell and Franklin Butler.

**McKeesport, Pa.**—The shareholders of the recently chartered McKeesport & Duquesne Street Railway company have elected the following named gentlemen as directors: E. P. Douglass, J. C. Smith, O. S. Wendell, E. F. Wood and Thomas Reynolds.

**Montreal, Can.**—At the fifth annual meeting of the Montreal Inclined Railway company, the following named gentleman were duly elected as officers and directors of the company for the ensuing year:

President—M. S. Walker.

Vice-President—W. J. Withall.

Secretary and treasurer—W. G. Turner.

Directors—M. S. Walker, W. J. Withall, J. O. Villeneuve, F. B. McNamee and Mm. Mann.

**Pittsburgh, Pa.**—The Pittsburgh, Alleghany & Manchester Electric Street Railway company has elected the following named gentlemen to serve as directors: John Dalzell, John D. Nicholson and Geo. B. Hill of Alleghany, and Wm. T. Mustin and Alexander M. Nespar of Pittsburgh.

**Santa Cruz, Cal.**—The following named gentlemen constitute the board of directors of the East Santa Cruz Street Railway company recently incorporated: Wm. Ely, I. L. Thunder, J. Sylvan, A. H. Bliss and W. D. Haslam.

**San Jose, Cal.**—At a recent meeting of the stockholders of the Electric Railroad company of this city the following named gentlemen were elected as officers and directors for the ensuing year:

President—J. H. Henry.

Vice-President—F. C. Franck.

Secretary—C. M. Wooster.

Directors—S. F. Leit, J. H. Henry, F. C. Franck, C. T. Settle and C. M. Wooster.

**Saratoga Springs, N. Y.**—At a recent meeting of the directors of the New Electric Railway company the following named gentlemen were duly elected:

President—J. L. Button.

Vice-President—W. B. Ferguson.

Treasurer—W. Coffin.

Secretary—J. M. Burt.

**Woonsocket, R. I.**—At a recent meeting of the directors of the Woonsocket Street Railway company, the Hon. O. J. Rathburn was elected president to fill the vacancy caused by the death of Horace Jencks. The management of the road was placed in the hands of its treasurer, Wm. Kent, who will act as general manager and have control of the operation of the road. Superintendent Young will remain in his present position. The reports of the road show that the income of the company will be fully one thousand dollars in excess of last year.

## EXTENSIONS.

**Danvers, Mass.**—The success of the Danvers & Beverly Electric Railway has been so great that the line is to be extended in the immediate future. The Union Electric Car Co's storage battery system is in operation.

**Harrisburg, Pa.**—The East Harrisburg Passenger Railway company will extend its lines on Perry street and from Steelton to the Half Way.

**Hutchinson, Kan.**—The Street Car company here will extend its tracks as far out as the works of the Hutchinson Salt and Manufacturing Co.

**Lowell, Mass.**—The Lowell Horse Railway company contemplates an extension of its lines to North Chelmsford.

It is not known what the motive power will be, but probably electricity will be adopted.

**Syracuse, N. Y.**—We understand that the Woodlawn & Bellam Street Railway Co. will extend its lines from Woodlawn Cemetery via De-

Witt street to Park street, to Oak street to Highland Place; thence to Willow street, Lock street to St. James street, and thence to beginning of road on North Salina street.

**Woonsocket, R. I.**—We understand that the Woonsocket Street Railway Co. will extend its lines in the immediate future, and electricity adopted.

## DIVIDENDS.

**Boston, Mass.**—The West End Street Railway company has declared a semi-annual dividend of 5 per cent. on common stock and 4 per cent. on the preferred stock of the company.

**New Bedford, Mass.**—At a recent meeting of the directors of the Union Street Railway of this city, a quarterly dividend of one and one-half per cent. was declared.

**Newport, R. I.**—The Newport Street Railway Co. has declared a dividend of \$350. per share for its capital stock.

## FOREIGN TRAMWAYS.

## AFRICA.

**Boma**—The trial trip of the Congo-Boma Steam Tramway was a complete success. Two locomotives will furnish the motive power. The line at present extends from the banks of the Congo river to the heart of the city of Boma.

## ARGENTINE REPUBLIC.

**Buenos Ayres**—Learning that a local company had already registered under a name very similar to its own the Buenos Ayres Metropolitan Tramway company has changed its title to the Buenos Ayres Grand National Tramways company, Limited. This line will be in complete running order by the end of January. The road is 26 miles long, solidly laid in concrete and first class in all respects. The enterprise is backed by English capital.

The Buenos Ayres and Belgrano Tramway has proved quite a successful enterprise. The line is thirteen miles long. The report to stockholders for nine months past showed an income of \$382,410.

## AUSTRIA.

**Buda-Pesth**—The Electricische Bahn Academie-gasse-Stadtwaldschen has been formally opened to the public. The contractors were Siemens & Halske.

Herr George Gerenday has submitted to the ministry a project to construct a bridge to span the Danube at this place, the same to be traversed by a tramway line.

**Vienna**—The Localbahn Ischl-Salzburg being assured of a franchise the interested parties will take steps to organize a stock company without delay.

## BELGIUM.

**Brussels**—The question of motor is now agitating the directors of the Brussels Trambahn-Gesellschaft. The majority is enthusiastically in favor of electricity. M. Michel Michelet, a director, was bitterly opposed to its introduction on account of its expense. He so vigorously persisted in this course and became so unpopular that his resignation was eagerly accepted. Mons. Dupnich was elected to his position.

The directors of the Brussels Trambahn-Gesellschaft, after a thorough investigation into the cause of the 400,000 francs less earned this year compared to last, have decided that an electric motor is imperatively necessary to regain lost ground.

## ENGLAND.

**Birmingham**—Sir John Fowler, K.C.M.G., and Mr. W. H. Preece, F.R.S., having been deputed by the Government of New South Wales to investigate the question of electrical traction in England, recently inspected the electric car constructed by the Electrical Construction Corporation for the Birmingham Central Tramways. They were accompanied by the chairman of the Central Tramways (Mr. Joseph Smith), Mr. W. J. Carruthers Wain-Asso C.E. (managing director), Mr. W. Neale (a director), and by Sir Douglas Galton, K.C.B., M. Julien (of Brussels), the Chevalier Grant (of Rome), Mr. Thomas Parker (works director of the Electrical Construction Corporation), Mr. Knox, Mr. E. Pritchard, M.I.C.E. (engineer to



the company), Mr. Piercy, M.I.M.E., with Mr. Alfred Dickenson, Mr. Herring, and other officials of the Central Tramways company. The trial was completely successful, and Sir John Fowler expressed the satisfaction with which he viewed so great an advance in electric traction.

#### GERMANY.

**Altona**—Owing to increased business caused by the many branch lines now controlled by the Grosser Hamburg-Altonaer Strassenbahn the capital stock has been increased to 1,000,000 marks.

**Berlin**—The Grossen Berliner Pferde-Eisenbahn-Actien-Gesellschaft carried in September last 9,850,846 passengers, for which was received 1,138,974.89 marks.

The Weddingplatz-Reinickendorf line was opened for business on December 15th last.

The street railway line between Knesebeckstrasse and Hermannplatz will be extended to Kaiser Friedrich Garten. The demand for tramway transportation to other points is so urgent that other extensions are under consideration.

The directors of the Grossen Berliner Pferde-Eisenbahn are awaiting the report of Messrs. Pfeifer and Schmidt, civil engineers, who have been commissioned by the above company to investigate the street railway systems of the United States, especially electric motors.

It is generally believed in street railway circles that electricity will provide the motor of the future.

The total number of accidents of street railway lines in this city for November last amounted to 118, of which 104 were passengers and 14 pedestrians: 70 being males and 48 females. Only one death occurred.

The Grossen Berliner Pferde-Eisenbahn-Gesellschaft, in November last carried 9,479,823 passengers over its lines, representing 1,088,957 marks.

The experiment of lining the interior of cars with woolen covering, as a guard against cold and draught having proved a perfect success the Berliner Dampf Strassenbahn will furnish their coaches, in future, with this protection.

**Bremen**—At an industrial exhibition to be held at Bremen next year the local tramway has decided to instal a Thomson-Houston Railway.

**Bremerhaven**—The Council has extended the franchise of the Bremerhavener Strassenbahn to January 1st, 1939, upon the condition that certain specified extensions be built before April 1, 1890.

**Breslau**—The November income of the Breslauer Strassenbahn foots up 64,372 marks.

**Bromberg**—The project of communication by tramway, between Bromberg and Thorn, is beginning to assume a tangible shape. The enterprise is very popular.

**Cassel**—The Casseler Strassenbahn has passed its dividend of 1888-'89 much to the disappointment of its shareholders.

**Cologne**—The Ringstrassenbahn will be extended to Chlodwigplatz this spring. This will give Cologne a much desired connection with many suburban points.

**Dortmund**—The 15th annual convention of the street railway interests of the Rhine and Westphalia districts, which took place on October last, was well attended.

**Dresden**—Track laying is almost completed on the new tramway enterprise which extends from Grungerstrasse to Lennestrass. The work will be prosecuted with vigor, with a view to its speedy completion.

The laying of rails in Uhlandstrasse begins to definitely prove that the long talked of tramway is decidedly no myth. Work is being rapidly pushed forward.

**Dusseldorf**—The Dusseldorfer Trambahn have notified stockholders that the payment of dividends will again be resumed commencing January, 1890.

**Eisenach**—It is definitely settled that the projected tramway will use the electric system.

**Elberfeld**—The question of an electric tramway is absorbing popular attention. The project is gaining friends daily and men of prominence have been won over to champion its cause. The general opinion is that the franchise for its construction will be granted ere long.

**Frankfurt**—On and after January 1, 1890, all

tickets purchased for the personal use of post-office, telegraph, railroad, court of justice, internal revenue and royal household employes on street railways will be entitled to 25 per cent discount.

It is reported that a wealthy syndicate will build a first class tramway line from Höchst to Soden Bad. The ground has already been surveyed.

The Frankfurter Offenbacher Trambahn Gesellschaft transported 1,069,979 passengers during a period of twelve months; earning during same period 143,237 marks.

The Frankfurter Trambahn was sued lately by a local resident for 600 marks for injuries received while stepping from the car. This is the first suit for damages ever brought against this company.

The Frankfurter Trambahn-Gesellschaft makes a showing of 78,730.60 marks for November.

**Furth**—The franchise which is expected by the Localbahn Zindorf-Furth will shortly be granted, and the work of constructing the road will begin this spring. The work will be pushed forward without delay.

**Gera**—Herrn. Hortsmann & Co, of Hanover, have received permission to construct a street car line through the principal streets. Work will be commenced without delay.

**Guben Forst**—That the Guben Forst Street Railway will be built has been definitely settled, 1,500,000 marks having already been subscribed. Shares, with a par value of 1000 marks, will be issued; several large banking concerns having offered to place the stock. Prince Heinrich von Schonaich-Carolan is heavily interested in the enterprise.

**Graz**—The project of Herr L. Schmidt, a prominent civil engineer, to build a cable road to Schlossberg, meets with favor in the city council.

**Halberstadt**—The Halberstadt Strassenbahn-Actien-Gesellschaft has met with poor success thus far. Notwithstanding an exceptionally economical management, and despite an income of 49,000 marks for 1888, the yearly profit only proved to be 124 marks. The unfortunate outcome was caused by the unexpected scarcity and consequent high price of horse feed.

**Hamburg**—The Fischmarkt-Suderstrasse Tramway Line is now receiving a new set of rails and undergoing a general renovation.

The directors of the Hamburg-Altona & Northwestern Tramways have placed an order for a large number of cars to be built of a new pattern, viz: the rear platform to contain seats. If popular, other roads will doubtless follow suit.

The Senate has granted the Grossen Hamburg-Altonaer Strassenbahn Gesellschaft a franchise for a new tramway line from Hohenfelde to St. Pauli, the road to be first class and completed and in running order this spring.

The statement of the Strassen Eisenbahn Gesellschaft, just issued, shows an income of 388,495 marks from Jan. 1 to Nov. 30, 1889 inclusive.

The report for November of the Hamburger Strassen-Eisenbahn-Gesellschaft shows a yield of 276,668.85 marks. The passenger business is on the increase.

**Hanover**—The street railway fare between Sandstrasse and Steinthor has been reduced to five pfennigs.

**Karlsruhe**—The gross earnings of the Karlsruher-Mühlberger und Durlacher Pferde und Dampfbahn Gesellschaft for last November was 15,570 marks.

The gross income of the Karlsruher-Pferdebahn for eleven months of 1889 amounted to 175,745 marks.

**Leipzig**—The new tramway to Schlachthof has been opened with immense enthusiasm, the crowds at times actually impeding the progress of the cars in their triumphal march to the terminus on the occasion of their first trip.

The passenger travel for November has yielded the Leipziger Pferde-Eisenbahn-Gesellschaft 276,668.85 marks.

**Lichterfeld**—The Lichterfeld Electric Tramway, lately consolidated with the Haupt-Kadettenanstalt Line, will be extended to the Potsdamer Depot.

**Mannheim**—The local tramway has received seven new cars of a new design and with many

improvements. This last importation makes a total of 97 cars in use.

The Trambahn Mannheim Ludwighofen report 22,207.94 marks as its earnings for last November.

**Minden**—A concession having been granted for a tramway to Porta, a number of capitalists have offered to furnish the necessary funds for its speedy completion. The offer has been accepted and work will commence when spring opens.

**Munich**—The Localbahn-Actien Gesellschaft at its last general meeting decided to issue bonds in the sum of 3,000,000 marks.

The question of the erection of waiting room stations at many of the street crossings—passed by local street railways—for the protection of passengers from the inclemency of the weather, accidents, etc., is now being agitated in the city council.

**Nurnberg**—For the accommodation of the patrons of the Grand Opera House the Nurnberger Strassenbahn will have three of their largest cars in attendance at the close of the performance to enable suburban residents to catch their trains for home.

**Schoenebeck**—The construction of a street car line has been commenced at Pretzien, to extend to the River Elbe. The enterprise being considered a desirable investment from the start no trouble was experienced in procuring the necessary capital.

**Spandau**—It is currently reported that a project is on foot to build an electric street railway line to connect Spandau with Potsdam, passing through Nedlitz, Krampinz and Gross-Glienicke.

**Stettin**—The board of directors of the Stettiner Eisenbahn have duly advised the stockholders that they can confidently expect much larger and hence more satisfactory dividends in 1890: the plant now being in a first class paying condition.

**Strassburg**—The municipal council is now busily engaged in revising the street car ordinances, etc. They have intimated that they will modify existing legislation so as to permit passengers to alight from the platform while the car is in motion, an action which is sternly prohibited at present.

**Stuttgart**—The Tramway company is now trying, as an experiment, the running of an extra car at 10.20 p. m. from Berg to Charlottenplatz, the fare being increased to 20 pfennigs. The outcome will be awaited with interest in Germany as experience has proven that the public will not pay extra fare for extra night service.

**Thorn**—Messrs. Haverstadt & Contag, contractors, of Berlin, have offered to build a tramway from Thorn to the city limits if the city council will financially assist the enterprise. The outlook is most promising.

**Trier**—M. de Ferral, of Brussels, has been granted a franchise for a street railway line to be built according to the plans of Herr Ludwig, work on same to be begun in spring and pushed forward without delay. The line will traverse the principal streets.

**Zabern**—The report that the Strassenbahn Lutzelsburg-Pfalzburg has consolidated with the Kaiserliche Reichseisenbahn is denied.

#### HOLLAND.

**Rotterdam**—The Rotterdamsche Tramway Maatschappij has reported its gross earnings for last August at 49,654.06 gulden.

#### INDIA.

**Bombay**—The Bombay Tramway company contemplates the extension of its lines. The electrical system is favorably considered.

#### IRELAND.

**Dublin**—The Privy Council has declined to pass the application for an order to construct the proposed railway through South Clare under the Light Railways and Tramways Act.

#### ITALY.

**Lodi**—The Societa Anonima della Tramvia Elettrica Lodi-Borghetto-San-Colombano-Chignolo has been formed for the construction and maintenance of an electric tramway, thus placing Lodi in communication with the neighboring cities. Capital: 500,000 lire. The Brush



Electrical Engineering Co. will supply the machinery and apparatus.

#### PORTUGAL.

**Lisbon**—The Lisbon Tramway company, notwithstanding that is one of the shortest lines on the Continent aspires to make a good showing. Whole cost of plant is 110,000 francs; working hours from 7 a. m. to 1 a. m. In 1887 a dividend of 19 per cent was declared.

#### RUSSIA.

**St. Petersburg**—At a meeting of a number of Russian street railway managers a car of a special design, called the "life saver" was exhibited. This car is completely surrounded at its base with sheet zinc—with stout brooms fastened at bottom—and almost touching the rails, the idea being to break the force of the wheels when passing over an obstacle. It is claimed that several persons who were in danger in being run over by this car owe their lives to this device.

A new street car line will be built next spring to extend from the Pokrowplatz to the Kolomenskij-Stadttheil.

**Moscow**—On the Second Horse Railway company, running between Sucharewa and Smolenski Rynok the switches have been located further apart than usual. Owing to the long single track the delay in reaching a switch to enable an opposite car to pass is considerable, and hence creates great dissatisfaction among the passengers, who must grin and patiently bear it.

#### SPAIN.

**Barcelona**—The aggregate earnings of the Barcelona Tramway company during the past eleven months is reported at £48,048.

#### SWITZERLAND.

**Birsigthal**—The secretary's report of the Birsigthal-Bahn gives the earnings for November as 9,687.75 francs.

**St. Gall**—The project of a cable car to the summit of the famous "Jungfrau" has again come to the front. Mons. Gossett, a civil engineer, having pronounced the plan feasible has boomed the matter considerably and capitalists are beginning to inquire into the practicability of the idea. It is estimated that the presence of 3,000 tourists annually can be relied upon to support the scheme, who prefer the iron cable as a means of locomotion to the iron pointed staff in this famous ascent.

The heavy snow storms lately experienced have completely stopped all passenger travel. This severe weather has proved disastrous to the St. Gallen-Gais Tramway Line both by loss of patronage as well as to injuries to depots and buildings by strain of the heavy crushing snow accumulated on the roofs.

**Zurich**—The Zurich Strassenbahn places its gross income for August last at 35,122.05 francs, showing a marked increase in travel.

#### TURKEY.

**Constantinople**—The Sultan has purchased from the owners Messrs. Dessand Freres the Tramway of Smyrna for a good consideration.

**Salonichi**—The Turkish government has granted Hamdy Bey a concession to build and maintain a tramway in Salonichi. The track will be a single one and will pass through Vadar, Beyaz and Coule.

#### Patents.

The following is a list of such patents as relate to Street Railway interests, issued during the past month, especially prepared for the Street Railway GAZETTE by Messrs. Higdon & Higdon, Solicitors of Patents and Trade-Marks, room 7, St. Cloud building, opposite U. S. Patent office, Washington, D. C. A printed copy of any patent here named will be furnished by them for 25 cents (stamps).

*Issue of November 5, 1889.*

- 414,481. Cable Carrier, A. B. Arnold, Chicago, Ill.  
414,183. Car Starter and Brake, W. A. Barker, Chicago, Ill.  
414,185. Passenger - Fare Collector, A. W. Berné, New Orleans, La.  
414,289. Switch for Electric Motor Trolleys, W. Christy, Akron, O.  
414,304. Cable Car Stopper, F. Espel, San Francisco, Cal.

- 414,210. Foot-Guard for Railways, T. A. Griffin, —, Ill.  
414,312. Car Starter, J. H. Heizer, Washington, D. C.  
414,222. Tower-Wagon for Electric Street-Car Service, T. L. Johnson, Cleveland, O.  
414,227. Slot-Closer for Railways, S. F. Leake, Philadelphia, Pa.  
414,239. Railway Rail Joint, J. M. and S. B. Moody, Harwich, Mass.  
414,575. Brake for Electric Car Trucks, L. Pfingst, Boston, and S. A. Bemis, Springfield, Mass.

- 414,445. Wire Rope Tramway, G. W. Pickett, and A. W. Pickering, Portland, Colo.  
414,589. Car Brake and Starter, J. Ross, Buffalo, N. Y.

- 414,659. Dynamo Electric Machine, W. Seafort, Chicago, Ill.

- 414,339. Time Recording Device for Dynamo-Electric Machines, H. C. Spaulding, Boston, Mass.

- 414,269. Gripping Device Carrier and Attachment thereto for Cable-Railway Cars, A. Twyman, Pullman, Ill.

- 413,609. Spring-Switch for Overhead Electric Conductors, E. J. Van Depoele, Lynn, Mass.

- 414,614. Pulley for Cable-Railways, J. Walker, Cleveland, O.

*Issue of November 12, 1889.*

- 414,746. Car-Axle Box, J. J. Anderson, Mexico, Mexico.

- 414,895. Sanding Attachment for Cars, J. W. Bates, Brooklyn, N. Y.

- 414,681. Device for Wire Cable Railways, F. E. Culver, Chicago, Ill.

- 414,878. Wedge or Key for Securing Railway Rails in Chairs, T. Despiou, Aigues-Mortes, France.

- 415,165. Electric Locomotor, Overhead Conductor, Electric Railway Co., Pittsburg, Pa.

- 414,900. Dynamo Electric Machine, H. Geisenhoner, Schenectady, N. Y.

- 414,977. Street or Station Indicator, Dayton Indicator Co., Dayton, O.

- 415,112. Truck for Street Railways, W. Joslin, Cleveland, O.

- 414,821. Cable-Railway, H. A. Pierce, Chicago, Ill.

- 414,921. Tie and Clamp for Railway Rails, F. Roberts and E. P. Eastwick, Jr., New York, N. Y.

- 414,825. Elevated Railway, A. Rodgers, and G. Mee, Muskegon, Mich.

- 415,070. Electric Motor Support, S. H. Short, Columbus, O.

*Issue of November 19, 1889.*

- 415,617. Suspended Car and Motor for Electric-Railways, L. J. Cody, Ste. Marie, Mich.

- 415,190. Dynamo - Electric Machine, T. E. Daniels, Jr., Provo City, Utah Ter.

- 415,551. Carrier - Track Cable-Curve, S. D. Northcutt, Los Angeles, Cal.

- 415,360. Car Ventilator, J. W. Fowler, Brooklyn, N. Y.

- 415,209. Elevated Suspension Railway, L. Johnston, Waco, Tex.

- 415,290. Railway Rail or other Joint, A. J. and G. W. Curry, St. Louis, Mo.

- 415,422. Railway Rail Joint, D. Rohlfing, Omaha, Neb.

*Issue of November 26, 1889.*

- 415,892. Car Truck, W. S. G. Baker, Baltimore, Md.

- 415,835. Car Starter, P. Flood, Albany, N. Y.

- 415,710. Separable Electric Conductor for Railway Gates, F. E. Fowler, Lynn, Mass.

- 415,727. Car Starter, J. J. A. Miller, Chicago, Ill.

- 415,924. Car Starter, S. J. Pearsall, Saratoga Springs, N. Y.

- 416,013. Dynamo Electric Machine and Motor, A. L. Riker, New York, N. Y.

- 415,991. Tramway with Vertical Tracks, C. Zipernowsky, Buda-Pesth, Austria-Hungary.

- 415,791. Journal-Box for Sheave-Wheels, W. Phenix, Chicago, Ill.

- 416,792. Oiling and Adjusting Device for Cable Sheaves, W. Phenix, Chicago, Ill.

*Issue of December 3, 1889.*

- 416,150. Railway Joint, A. Bagley, Ypsilanti, Mich.

- 416,396. Metallic Railway Rail Tie, J. Caseley, Knightstown, Ind.

- 416,211. Fare Register, R. Clarke, Kansas City, Mo.

- 416,443. Magneto-Electric Machine, W. H. Cooley, Brockport N. Y.

- 416,668. Car-Coupling, J. Coup, Euclid, O.

- 416,449. Switch for Cable-Railways, D. Donovan and J. Geisenheimer, New York, N. Y.

- 416,673. Cable-Grip, J. W. Gentry, Oakland, Cal.

- 416,220. Elevated Cable Railway and Car, A. L. Grinnell, Campbell, Iowa.

#### Expiring Patents.

The following patents will shortly be public property, and may be used by anyone.

Manufacturers may determine to what extent they may act independently of patent rights, and inventors may gain an insight into the prior state of the art by consulting copies of them.

A printed copy of the drawings and specifications of any of the following will be furnished by Messrs. Higdon & Higdon for 25 cents.

*Expire during December, 1889.*

- 133,629. Car Brake, F. M. Chapman.  
133,559. Railway Frog, J. Brahn.  
133,790. Car Axle, G. W. Miltmore.  
134,060. Street Car, W. H. T. Hughes.  
133,952. Car Spring, J. B. Quirk.  
134,321. Fare Box, J. B. Slawson.  
134,174. Railway Rail Joint, A. B. Stone.  
134,437. Car and Axle Coupling, W. S. Nearing.  
134,393. Car Coupling, J. Morton.

#### Personals.

On New Year's eve, we were favored with a call from Mr. Wm. S. Turner, of Woodbridge & Turner, of New York. Mr. Turner had been to Nashville, and left for Quincy, Ill. He will visit Nashville again before he returns to New York.

He reports that his firm did a splendid business last year, having constructed or equipped about a dozen electric railways (a list of which appears in the advertisement of the firm in this issue).

Mr. Bernard H. Schmidt, western selling agent of the J. G. Brill Co., recently made a very successful raid into Michigan and Ohio.

Mr. J. A. Rhomberg, president of the Dubuque (Ia.) street railway company, favored us with a call last week.

Mr. D. W. Pugh, the ever popular representative of the John Stephenson company, was met in the East lately.

Mr. John A. Brill of Philadelphia favored our city with a call since our last issue, and went on to St. Louis.

Mr. E. H. Johnson, late president of the Sprague Electric Railway and Motor company, visited Chicago last week. He was accompanied by Mr. C. A. Benton of the same company, who is one of the most energetic and popular of those gentlemen connected with the supply business.

#### Married.

WOODBIDGE—FOSTER.

Mr. J. Lester Woodbridge, of the enterprising firm of Woodbridge & Turner, of N. Y., was married to Miss Edith Foster of Brooklyn, N. Y., on November 27th. The ceremony, took place at Unity church, in Brooklyn, and a charming reception was held in the evening at the residence of the bride's parents.

Mr. and Mrs. Woodbridge spent their honeymoon at Old Point Comfort. The GAZETTE is always pleased to chronicle the wedding of one of its friends, and while adding its hearty congratulations to the hundreds already received by Mr. Woodbridge, sincerely trusts that the newly married couple may have a long career of unalloyed happiness before them.

#### Born.

On January 3, 1890, at 418 Elm street, Chicago, a daughter to Mr. and Mrs. H. McL. Harding.

[The GAZETTE tenders its modest congratulations to Mr. and Mrs. Harding, upon the cause of the foregoing announcement, and wishes them every joy in their newly found happiness.]



**Died.**

ALBERT EAMES.

Albert Eames, one of the park commissioners of Bridgeport and president of the Bridgeport Horse Railroad company, died at his home in Bridgeport, Dec. 15th, aged seventy-eight years. He was identified early with the manufacture of firearms, and while at the Remington Works at Illion is said to have been one of the first to employ the system of making the parts of a weapon to gauge and afterward assembling them by different workmen. For more than fifty years he was a contractor with the Wheeler & Wilson sewing machine works.

RUFUS MARTIN.

It is with the deepest possible regret that we have to record the death of Mr. Rufus Martin, which occurred on the sixteenth of last month in New York City, from injuries sustained by being thrown out of his carriage in Central Park, while enjoying a drive in company with the young lady to whom he was engaged to be married. Mr. Martin was well known in street railway circles, being a member of the firm of Martin & Breckenridge, of New York. He had travelled extensively and was only twenty-six years old when he met with his untimely death. Those who knew him well, we are sure, join the GAZETTE in bewailing the loss of so bright and promising a young man.

HON. WM. G. BROWNLEE.

The Hon. Wm. G. Brownlee, of the well known firm of Brownlee & Co., Detroit, Mich., met his death on Nov. 25th, through an accident which occurred at his own factory.

The deceased was over fifty years old, and a prominent advocate of the doctrine of free trade.

**Business Notes.**

WALKER'S DIFFERENTIAL DRUM.

In view of the fact that it has been stated that the Metropolitan Street Railway of Kansas City, have been compelled to discard the use of the Walker Differential Drum, the following will serve as an answer.

Office of Metropolitan Street Railway Co.

KANSAS CITY, Mo. Dec. 12, 1889.

Mr. Edwin Owen, Chief Engineer

Valley City Street & Cable Railway Co.  
Grand Rapids, Mich.

Dear Sir: We have several of Walker's Differential Drums in use, and find that they have given good satisfaction.

Your information that we have been compelled to throw away these drums is not correct in any part.

Signed:

Yours truly,

R. J. McCarty,

General Manager.

Office of Metropolitan Street Railway Co.

KANSAS CITY, Mo., Dec. 18, 1889.

The Walker Manufacturing Co., Cleveland, O.

Gentlemen: Answering your inquiry as to the machinery which you have furnished this company for the Twelfth Street, and Eighteenth Street Cable Lines, which we have had in use for over a year, we find that it has given general satisfaction.

We find that your Differential Drums have many excellent features and can cheerfully recommend their use to others.

We also find that your clutches have given good satisfaction, and of the two kinds, which you have furnished, we are of the opinion that your improved clutch which you furnished for the Eighteenth Street Line is the best.

Yours truly,

Signed

R. J. McCarty,

General Manager.

Encouraged by the increased demand for Electric Mining Apparatus, and pushing forward with its wonted enterprise, the Sprague Co., has prepared a number of special sets of Electric mining tools and machines, and is earnestly seeking to give the ingenuity of the inventor its best expression, and highest utility. It will be pleased to furnish full information and particulars of its machinery to those interested in the subject through its western office, Rialto Building, Chicago, Ill.

This plant is in addition to the one recently contracted for in Seattle.

It has also closed a contract with the Denver

Tramway Co., of Denver, Colo., to put in eight of its Patent Differential Drums in place of the solid drums and idlers which have only been in use about one year. It also has the contract to supply a new tension carriage and considerable other machinery.

The celebrated K. K. insulated copper wire has been adopted by the following named Electric Railroad Companies:

Central Railway Co., Davenport Iowa.  
Electric Street Railway Co., Lafayette, Ind.  
East Cleveland Railroad Co., Cleveland, Ohio.  
Stillwater Electric Ry. Co., Stillwater, Minn.  
Tacoma Electric Railway and Motor Co., Tacoma, Washington Territory.  
City Railway, West Bay City, Mich.  
Union Railway Co., Sterling, Ill.  
Inclined Plane Railroad, Cincinnati, Ohio.  
Eau Claire Street Rd. Co., Eau Claire, Wis.  
Key City Electric St. Ry. Co., Dubuque, Iowa.  
Buffalo Street Railway Co., Buffalo, N. Y.  
Soldiers' Home Railway, Dayton, Ohio.  
Central Railway Co., Moline, Ill.  
Piqua Street Railway Co., Piqua, Ohio.  
Sioux City Street Ry. Co., Sioux City, Iowa.  
Cicero & Proviso Street Railway, Chicago, Ill.  
Peoples' Street Railway Co., Scranton, Pa.  
South Denver Tramway Co., Denver, Colo.  
Peoples' Street Railway Co., St. Joseph, Mo.  
Railway Company, Salt Lake City, Utah.  
Wichita and Suburban Ry. Co., Wichita, Kan.  
Messrs Holmes, Booths & Haydens of New York have every reason to be proud of their record in this connection.

The Thomson-Houston Company has made the Central Thomson-Houston Company its Cincinnati agents with office at 1337 F Street, Washington, D. C. Frank H. Clark will be manager of the new office.

The Pond Engineering Company's business in the furnishing and erecting of complete steam plants, for electrical and manufacturing establishments, is growing rapidly. At the present moment it is furnishing the New Omaha, Thomson-Houston Co., with a two hundred horse power, compound, condensing, Armington and Sims engine. The Murphysboro Water Co., Murphysboro, Ill., with a complete 75 horse power outfit, the Fairfield Gas Co., of Fairfield, Iowa, with a complete 70 horse power outfit, the Edison Electric Illuminating Co., of New Orleans, La., with a 150 horse power, Armington & Sims engine, and the Westinghouse System on Lighting, in Independence, Iowa, with a 60 horse power outfit. It has lately sold a Lowe Feed Water Heater, and a Hoppes Live Steam Purifier, to the Hydraulic Press Brick Co., in Kansas City, and Washington, D. C., and its sales of Individual boilers, Blake Pumps, and Korting Injectors are quite large.

**Books, Catalogues, etc., Received.**

PRATT & LETCHWORTH, Buffalo, N. Y., send us a copy of a recently issued catalogue, descriptive of the saddlery and hardware specialties suitable for street railways.

The catalogue is printed on heavy paper, and contains no less than 32 pages of handsome illustrations, printed in color. Every kind of hame is shown, as well as hame clips, staples, breast rings and studs; hame rivets and bottom loops; roller buckles, hame-strap buckles, bracons, band hooks, etc.

To superintendents and managers of horse railroads, contemplating the purchase of similar articles, the catalogue will prove invaluable.

BRODERICK & BASCOM ROPE CO., of St. Louis, send us a catalogue of 104 pages, profusely illustrated. It shows in detail the uses to which the cable can be put in mining operations; treats of the construction of cable roads, rope transmission, underground hauling, etc., and gives an almost endless number of illustrations of apparatus peculiar to the enterprises described.

THE WALKER MFG. CO., of Cleveland, sends us a copy of its Souvenir to the Pan-American delegates. It consists of a 14 page illustrated catalogue, descriptive of the cable railway devices

made by the company, etc., and concludes with a list of roads upon which its apparatus has been adopted.

THE BUFFALO STREET RAILWAY COMPANY sends us a neat little pamphlet entitled "Rapid Transit in Buffalo," in which reference is made to The Cable System, The Storage Battery System, The Conduit System, and The Overhead Wire System. We have long known it to be the expressed desire of the Buffalo Street Railway company, and the Buffalo East Side Street Railway company, to give their patrons just what they wanted, and it is very likely that the circulation of this valuable and logical pamphlet among the public in Buffalo will bring forth an expression of opinion from them which will serve as a guide to the managers of the two companies, as to what kind of "Rapid Transit" will best suit the majority.

SPRAGUE ELECTRIC EQUIPMENT CO., with its usual Chicago enterprise, has issued another new catalogue. The size of the old one has been increased to 19 pages and cover. It is profusely illustrated with cuts of station material, such as lightning arresters, lamp sockets, receptacles, etc.; car equipment material, such as contact buttons, electric headlights, car connecting plugs, trolley base, trolley wheel and post, etc. Track brooms and line material, such as pole brackets, ratchets, rail bonds, curve brackets, wire insulators, switches, etc.

The Sprague Electric Equipment company never does anything by halves, and the issue of this new catalogue is but the forerunner of one far more complete and comprehensive.

Pratt & Letchworth, of Buffalo, recently sent us a very handsome paper knife, or letter opener, being a miniature sample (nickel) of their famous Buffalo Hames; the possession of one of these useful devices should surely tend to keep it before the fortunate owner, and we desire to express our thanks for the kind remembrance.

**Opening of the Standard Theatre.**

All arrangements for the opening of the Standard Theatre next Sunday matinee, January 12th, have been completed. Mr. Jacob Litt, the young and pushing manager, has added Chicago to his circuit, and in securing the Standard Theatre will place before the public the first-class attractions that have pleased the patrons and made him the most popular manager in Milwaukee, St. Paul and Minneapolis. The entire interior of the Theatre has been renovated and re-decorated. The artists that have been employed have combined to blending the colors used, presenting a rich, fresh, but subdued elegant effect. New and handsome carpet will be laid down the aisles, lobby and ladies' reception rooms, where a maid will always be in waiting to attend to the wants of the patrons. New folding chairs have been placed in the parquet, and were carefully selected for comfort and ease, avoiding that common mistake of managers by crowding the seats, to the serious inconvenience of theatre goers. The gallery has not been omitted, with a view to the interest of the boys. Mr. Litt has removed the old eyecore, the lower row of seats that projected to a point, and obstructed the view of those sitting in the back, so that now there is not a seat (not only in the top gallery), but nowhere in the entire house, but has a commanding view of the stage. The front of the house will receive a new coat of paint as soon as the weather will permit. Brush electric lights will be placed in proper position outside. The interior of the house will have a long needed improvement in the fact of being well lighted and ventilated. In fact, everything that can be done to secure the comfort of patrons has been anticipated and thoroughly carried out. The opening attraction will be "The Runaway Wife," presented by Mr. McKee Rankin and Miss Mahel Burt. It is a strong drama, and has been well with success throughout the East and West by Mr. Rankin and his admirable company. Popular prices and first-class attractions will reign supreme at the Standard.

**OFFICIAL NOTICES.**

THE ANNUAL MEETING OF STOCKHOLDERS OF THE Forty-second Street, Manhattanville and St. Nicholas Avenue Railway Company, for the election of thirteen Directors and three Inspectors of Election will be held at the office of the company, 118 East 42d-st., on THURSDAY, the 16th day of January, 1899, at 12 o'clock noon. Polls open from 12 to 1 P. M. Transfer books of this company will be closed until the morning of Jan. 17, 1899.

C. F. NAETHING, Secretary.

THE ANNUAL MEETING OF THE STOCKHOLDERS OF THE St. Paul City Railway Company—Notice is hereby given that the annual meeting of the stockholders of the St. Paul City Railway Company will be held at the general office of said company in its building at the northwest corner of Ramsey and Oak streets in the city of St. Paul, Minn., on the second Monday of January (being the 13th of said month), 1899, at 10 o'clock A. M. Dated at St. Paul, Minn., Dec. 28, 1889. A. Z. Leverlog, Secretary of the St. Paul City Railway Company. To the stockholders of the St. Paul City Railway Company.

THE ANNUAL MEETING OF THE STOCKHOLDERS OF THE York Street Railway Company will be held at the office of the Company, No. 4 West Market Street, York, Pa., on Monday, the 13th day of January, 1899, between the hours of six and eight o'clock P. M., for the election of a President and six Directors for the ensuing year; take action on by-laws, rules and regulations of the Company, to consider the advisability of accepting the provisions of the Act of Assembly, entitled "An Act to provide for the incorporation and government of street railway companies in this commonwealth," approved May 14, 1889, and also

To take action on the matter of increasing the capital stock of said company, and transact such other business as may be deemed advisable.

D. K. TRIMMER, Secretary.

THE FIRST ANNUAL CONVENTION OF THE WESTERN ELECTRIC RAILWAY ASSOCIATION will be held at the Grand Pacific Hotel, Chicago, at 10 A. M., January 29th, 1899.

W. L. ALLEN, Secretary.



Electric Street Railways in North America.

IN OPERATION OR UNDER CONTRACT, NOV. 1, 1889.

Table with columns: OPERATING CO., LOCATION, SYSTEM, CARS, MILES. Lists various street railway companies and their operational details across North America.

Table with columns: OPERATING CO., LOCATION, SYSTEM, CARS, MILES. Continuation of the list of street railway companies and their details.

Street Railway Securities. NEW YORK AND BROOKLYN.

Table with columns: NAME OF COMPANY, Par Value, Capital, Period, Rate, Date, Bld., Asked. Lists securities for various street railway companies in New York and Brooklyn.

ST. LOUIS.

Table with columns: NAME OF COMPANY, Par Value, Capital, Period, Rate, Date, Bld., Asked. Lists securities for various street railway companies in St. Louis.

HOLYOKE.

Table with columns: NAME OF COMPANY, Par Value, Capital, Period, Rate, Date, Bld., Asked. Lists securities for various street railway companies in Holyoke.

PROVIDENCE.

Table with columns: NAME OF COMPANY, Par Value, Capital, Period, Rate, Date, Bld., Asked. Lists securities for various street railway companies in Providence.

Bond Offerings.

OFFERED BY ROLSTON & BASS, 20 BROAD ST., NEW YORK.

Table with columns: Rate, Price, Pays, Amt. Offer'd, Mature, Int. Pbl., Miles, Bnd. p. M., Issue, Not Enr'd. Lists bond offerings from Rolston & Bass.

OFFERED BY ROBT. GLENDINNING & CO., PHILADELPHIA, PA.

Table with columns: Rate, Price, Pays, Amt. Offer'd, Mature, Int. Pbl., Miles, Bnd. p. M., Issue, Not Enr'd. Lists bond offerings from Robert Glendinning & Co.

OFFERED BY S. V. WHITE & CO., 36 WALL ST., NEW YORK.

Table with columns: Rate, Price, Pays, Amt. Offer'd, Mature, Int. Pbl., Miles, Bnd. p. M., Issue, Not Enr'd. Lists bond offerings from S. V. White & Co.

Consolidated Street Railway Company, Columbus, O., 1st m. gold.

Table with columns: Rate, Price, Pays, Amt. Offer'd, Mature, Int. Pbl., Miles, Bnd. p. M., Issue, Not Enr'd. Lists bond offerings from Consolidated Street Railway Company.

OFFERED BY HARRIMAN & CO., 130 BROADWAY, NEW YORK.

Table with columns: Rate, Price, Pays, Amt. Offer'd, Mature, Int. Pbl., Miles, Bnd. p. M., Issue, Not Enr'd. Lists bond offerings from Harriman & Co.



# The Street Railway Gazette.

(Copyrighted, 1890.)

VOL. V.

FEBRUARY, 1890.

No. 2

## ELECTRIC RAILWAYS.

### Westinghouse Compound Engine and Alternator.\*

In this type of engine, which, in general form, resembles what is known as the Westinghouse Jr. Automatic Engine, the area of one cylinder is enlarged  $3\frac{1}{2}$  times that of the other. The valve chest lies across the top of the cylinders as shown. It is cast in one piece, the various steam passages being chambered in it. The

performed through feed-pipes, which are supplied from sight feed-cups. The cranks are lubricated the same way as those in the automatic engine. These compound engines are designed to be run at high speed, the piston velocity ranging from 333 feet per minute in engines with a stroke of 6 inches, to 700 for a stroke of 20 inches. The sizes range from 5 to 500 horse power.

In the illustration it will be noticed that the engine is belted to a Westinghouse Alternating Dynamo.

### South Broadway Electric Railway, St. Louis.

When in St. Louis a week or two ago a representative of the GAZETTE, in company with Messrs. Short and Rogers, of the Electric Railway of Cleveland, Ohio, made a trip over the line and found it working in every way satisfactorily. The power house contains one 24 by 38 automatic cut-off Wheelock engine, with an indicated horse power of 250, which was running at about 67 revolutions per minute. There was also one tubular boiler of 72 inch shell, 18 feet long, with

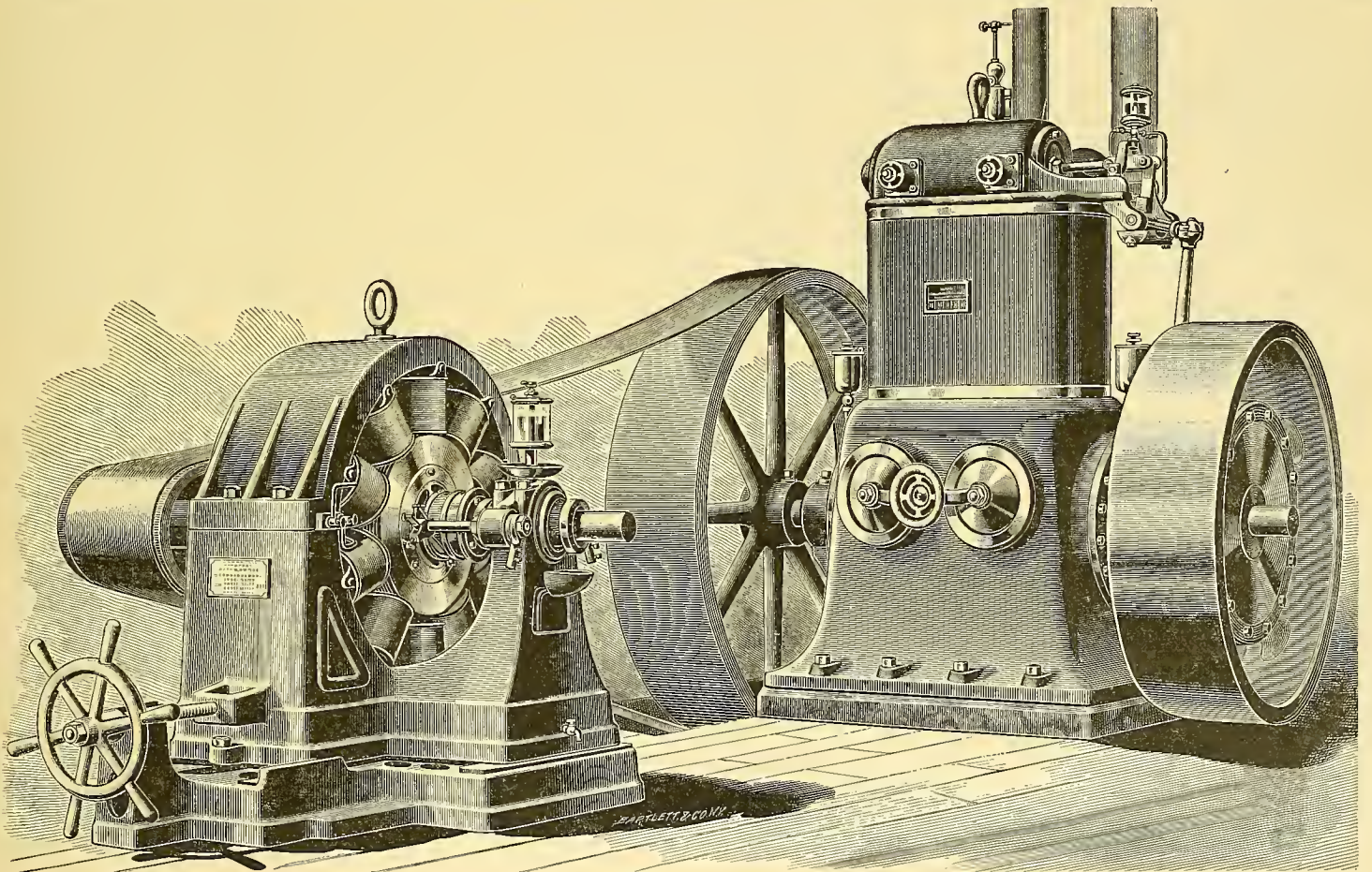

valve chest also contains a small valve by which live steam can be admitted to the low pressure cylinder. By the use of this valve the engine may be turned "off center" when starting. The main valve is cylindrical, and is actuated by a single eccentric controlled by a governor carried in a fly-wheel. The use of a single valve and eccentric is a feature in this engine. As all the parts of the governor except the eccentric are inclosed in a case which, at the start, is filled with oil, it requires no attention for a considerable time. The lubrication of the pin connections and eccentric is automatically

### Storage Battery Cars.

We understand that during the year ending Dec. 31, 1889, the Julien Storage Battery cars have made between the city hall and Eighty-sixth street, on Madison avenue, nearly 40,000 miles and carried over 250,000 passengers. This has been done without any accident to person or property. The superintendent of the New York & Harlem railway, who is also at the head of the syndicate which is building the Twenty-eighth and Twenty-ninth, Thirty-third and Thirty-fourth street lines in this city, has decided to introduce 100 cars of the storage system on those lines.

a capacity of 150 horse power; and one boiler made in Cleveland with 56 inch shell, and 16 feet long; three Brush open coil generators with 60,000 watts each, running 900 revolutions per minute. One Payne engine, 15 by 30, of 125 horse power, and two Schultz belts. At that time but two engines were in operation, and the company expects to increase its power capacity considerably in the immediate future.

The Commercial Club of Kansas City, will give the Delegates to the Electric Light Convention a reception on the evening of February 11th.

\* Westinghouse Electric Co., Pittsburg, Pa.



Practical Points in Electric Car Service.\*

BY O. T. CROSBY.

The following statement of facts results from observations made by Messrs. J. H. Vail, C. L. Edgar, William Habirshaw and myself, in the month of May, 1889. The number of individual readings taken was too great to permit repetition here. The system of observation was this: Volt and ampere readings were taken at 30-second intervals, the instruments being placed on a car in each of the three cities, Richmond, Va., Cleveland, O., and Scranton, Pa. Notes as to passengers carried, stops made, etc., were taken on the car. Averages for long periods were taken from records kindly furnished by the railway companies in Richmond and Cleveland. On the three lines, which were carefully examined, the motors used were those of the Sprague company's first type, save in the case of one car in Cleveland, which was run by motors of the Sprague company's second type. The dynamos were of the Edison type. We obtained much interesting information by inquiring at the central station of the Eckington and Soldiers' Home railway, Washington, D. C. This road has motors and dynamos of the Thomson-Houston company. The facts given concerning this road are to be understood as not authenticated by instrumental checking. While the observations from which conclusions will be here drawn, are now perhaps the most detailed and extensive of their kind, I hope many such will soon be on record, giving final values to certain important constants. More nearly than anything else, I believe that the car mile is the unit of earning capacity, a certain population per mile being assumed. Hence the prominence of that unit below. The unit car may be taken as the regular 16-foot car. In Washington double-deckers constitute part of the equipment and appear very attractive.

Coal Consumption.—We yet lack any accurate scale showing values of different coals as heat producers. Taking things as we found them:

Table with 2 columns: Location and coal cost per ton. Includes Washington, Richmond, Cleveland, and Scranton.

The coal consumption per car mile in these cities was as follows:

Table with 2 columns: Location and coal consumption in lbs. per car mile. Includes Washington, Richmond, and Cleveland.

The car mileage per day of entire service in Washington, can not be considered accurate; it was made up from the "say-so" of station employes, not referring to written records. Its error is probably not greater than 10 per cent.

Cost of coal per car mile.

Table with 2 columns: Location and cost of coal per car mile. Includes Washington, Cleveland, and Scranton.

Attendance.—In this I include only the attendance necessary for producing and delivering power, and nothing for conductors and drivers. Engineers, firemen, motor cleaners, linemen, and a part of general superintendence constitute this item.

Cost per car mile.

Table with 2 columns: Location and cost per car mile. Includes Washington, Richmond, Cleveland, and Scranton.

Oil, waste, water, etc.—No great error will be made in putting this at 0.2 cent per mile at all points.

Interest, Insurance, Depreciation and Taxes on Real Estate per Car Mile.—The value of real estate in the plants visited was not readily attainable. It was in no case used to its maximum capacity, and values per horse power of total capacity varied very much. So, also, as to tax rate. The figures I will use must be understood as not founded on authentic data, but on fair approximation. The value of real estate for plant making 1,000 car miles per day is taken at \$15,000; interest at 5 per cent; depreciation at 2 per cent; insurance and taxes at 2 per cent; total, .9 per cent.

Applying this to \$15,000 and dividing by 365 x 1,000, we obtain 0.37 cent per car mile.

Machinery and Line.—The cost of maintenance of the electrical machinery of a street railway has been the subject of much inquiry. The "extreme youth" of the art offers sufficient explanation of the vagaries shown by this element of cost. It has sometimes been riotous, like a boy out of school; sometimes quiet, like a boy after a flogging. At this date, maintenance on any road installed by one of the few well known companies in the business will show a much more modest front than it did even six months ago. If we should take periods of six months on the roads in question they would, doubtless, all show great fluctuations in the depreciation figure. When, therefore, I take five per cent, per year on the whole electrical equipment, dynamos, motors and line, I am giving expression to an opinion founded on many and varied happenings constituting quite a thorough practical experience in the work. Further, I must say that we will understand depreciation values one year from to-day much better than we do now. My five per cent, is "subject to change without notice," though guaranties very near this figure can now be had from reliable companies. Include in the plant on which five per cent, maintenance is to be calculated, the boilers and engines, and this percentage becomes still safer. It may be remembered that dynamo maintenance is known to be less than five per cent.; line maintenance by care can be kept inside that figure; hence, even if motor maintenance exceed that five per cent., our average remains nearly correct.

The total cost of steam and electric machinery and line equipment sufficient to perform a service of 1,000 car miles per day is an element as variable as the cost of real estate. As yet, also, we often find a capacity in excess of actual service. The use of iron poles, instead of wood, will add from \$800 to \$1,600 to the cost of each mile of road.

In the systems here treated, the numbers of car miles per day made on each mile of line work are pretty closely as follows:

Table with 2 columns: Location and car miles per day. Includes Washington, Richmond, Cleveland, and Scranton.

Differences in the proportions of single and double track and actual traffic demands largely affect such figures. The cost per mile of overhead work for various sets of conditions is now quite regular; but variation in the condition is considerable. Thus, nature of soil, kind of pavement, kind of rail, distance from station, number and size of cars, per mile grades, volume of traffic, number of trees on line, kind of pole, general finish of line, local price of labor, freight charges—all these enter. Again, I will here use probable values rather than actual costs of the above lines, on one of which especially a considerable expenditure was made for that valuable but intangible commodity—experience. I will, therefore, assume:

Table with 2 columns: Location and average cost per mile. Includes Richmond and Scranton (wood-poles), Cleveland (double track, iron poles), and Washington (centre pole of iron).

These investments may be considered as sufficient to support more than the car mileages above given, but average traffic may not demand more. The investment for motors per car mile is now generally larger than it need be if traffic were everywhere heavy enough to demand double-car service (one motor car, one two-car). The equipment is frequently sufficiently powerful to do towing service when no such service is required. This figure also varies, in case of single car service, with what the owners choose to get out of their plant. Thus, in the points visited, average car miles per day for each motor car in service were:

Table with 2 columns: Location and car mileage. Includes Cleveland, Washington, Richmond, Scranton, and Cleveland.

Since the date of inspection, the car mileage per day per car has increased greatly in Cleveland, and I think, in Washington also.

The cost of motor equipments per car may now be taken at about \$2,500. The dynamo capacity required to drive each car will generally be found to be from 7.5 to 10 h. p. When the number of cars is considerable, the lower figure will apply to even the hours of heaviest traffic, but the desire to have a margin on dynamo capacity, thus permitting some increase in number of cars without increase of station plant usually operates to give the larger figure, and often a higher one still. Actual readings, extending over long periods, showed a maximum of 7.5 h. p. per car, called for in Cleveland and Richmond, from 16 to 20 cars being on the line. The "say so" of station employes in Washington and Scranton indicated about the same figure.

We may, therefore, assume 10 h. p. of dynamo capacity as installed for each car on the line. Save in very small units, the cost, covering spare parts and all station equipment may be taken at \$45 per horse power.

The cost of engines and boilers is very near the same figure per horse power, and we may assume 11 h. p. installed for every car in service. We may now sum up as to machinery and line work. Interest will be taken as before at five per cent.; maintenance as explained, at five per cent.; taxes and insurance at two per cent.; total, twelve per cent.

Then the cost per car mile =

Cost one mile of line x 0.12 / 365 x car miles per car, plus Cost one car equipment x 0.12 / 365 x daily mileage per car, plus Cost 10 h. p. dyn mo x 0.12 / 365 x daily mileage per car, plus Cost 11 h. p. steam plant x 0.12 / 365 x daily mileage per car

Applying the figures above given we have for

Table with 2 columns: Location and cost per car mile. Includes Washington, Richmond, Cleveland, and Scranton.

Total Average 1.85 cents

In (3), above, the large number of car-miles per mile of line, and good figure for car mileage per car, bring the total down, in spite of an expensive line. Bringing all the items of cost per car-mile together, we have, for motive power:

Table with 5 columns: Location, Coal, Attendance, Real estate, Machinery and Oil and waste, Total. Includes Washington, Richmond, Cleveland, and Scranton.

Average 5.69

The figures for Richmond marked (?) were not attainable. Coal and labor being of nearly the same values as in Washington, equality in these items has been assumed.

Interest on investment constitutes about one fourth to one fifth of the whole, i. e., about one cent per car mile, or, say 20 per cent. of the total. Coal (except in the abnormal case of Scranton) is about 12 per cent.; attendance about 40 per cent.; machinery and line (without interest) about 20 per cent.

Effect of Grade.—Out of a total of 120 readings on a car in Richmond, going over a line of heavy grades, there appear 29 zero readings for current, and of these not more than 6 were due to the fact that the car was at rest when the moment for record came. Let us take, however, only

20 readings as made while the car was in motion; that means that during one-sixth of the total time of run, gravity and momentum effects combined, made it unnecessary to use current to keep the car in motion.

Out of 120 readings in Cleveland, over a practically level road, only 15 zero readings are found, and nearly all these were noted as "stops." In other words, grades work both ways, and keep average currents down to better figures than might be expected.

Comparison of maximum efforts, however, indicates the disagreeable character of grade work, thus:

Maximum supply of energy observed at one reading.

Table with 2 columns: Location and maximum supply of energy. Includes Richmond, Cleveland, and Scranton.

Reading (1), was taken on a 9 per cent. grade; load, about 8,500 pounds; reading (2), on a very slight grade, with a load of about 9,800 pounds; reading (3), on about a 7 per cent. grade, load about 8,800 pounds. On other occasions in Richmond I have seen, with extravagant loads, readings nearly 50 per cent. greater than the 25.6 above.

An important relation to be observed, as facilitating calculations, is the relation between car mile and horse power hour. This relation was found to be:

Table with 2 columns: Location and relation between car mile and horse power hour. Includes Richmond, Cleveland, and Scranton.

Average .94 h. p.

The loads in the special tests were ordinarily from four passengers to twenty four. In these figures the beneficial effect of small grades is seen. It is probable that the average number of passengers carried per car mile is in Cleveland (type of light grades) greater than in Scranton or Richmond (type of heavy grades), otherwise the difference would be greater between the heavy grade and the light grade roads.

It is to be noted that the horse power here considered, is that delivered to the cars. To learn what the same relation is when carried to the power house, we must next learn of the line efficiency. Taking figures of special tests, this is as follows:

Table with 2 columns: Location and line efficiency. Includes Richmond, Cleveland, and Scranton.

These percentages will not, of course, be maintained at hours of heaviest traffic. In (1) and (3), a number of track connections were broken, causing considerably more than necessary loss with the copper actually in the line. Whatever the loss may be in these three roads, we all know that the loss may be made what we please. Let us take it at 10 per cent. It may then be said, closely enough for anything less than very accurate calculations, that on average roads one electrical horse power hour in the station will produce one car mile of service on the line.

Nearly the same value for this relation may be deduced from figures published by Dr. Louis Bell taken from practice of the Lafayette, Ind., electric railway (Electrical World, June 22, 1889). He says that 16.1 pounds of coal were required to produce one electrical horse power hour. He says that six cars are in use, making from 35 to 40 miles per day. We may assume then about 230 car miles per day.

Total coal consumption for the day was given as 4,500 pounds; 4,500 / 230 = 19.5.

Hence, one car mile = 19.5 / 16.1 or 1.22 electrical horse power hours.

The figure for coal is very high as compared with practice in a great majority of electrical stations, for either light or power. Coal per indicated horse power hour is given by Dr. Bell as 7.3. This is high enough, but the jump to 16 pounds per electrical horse power hour, shows poor steam and shafting service, or error in calculation. Another relation calculated, that between maximum two-hour supply of energy and average supply of energy, may become of importance, especially in the case of purchase of power by meter, the seller wanting to know beforehand how much current he can sell from a certain plant for car service. The plant must have normal capacity to supply the maximum effort continuing for a reasonable time, say one hour, while it may be relied on to "spurt" for an extravagant, but very short demand.

I found that in Richmond, with about 21 cars out, readings, extending through several days, showed a current of 220 amperes as flowing continuously for one hour, while the average of same readings, reduced to 24 hours per day, equalled 110 amperes, or 50 per cent. of the one hour maximum. In Cleveland, corresponding figures were respectively, 173 amperes and 66 amperes, i. e., 38.3 per cent.; 16 cars being in service. Taking the mean of 50 and 38, that is, 44, we may say that, on average roads only 44 per cent. of the 24-hour capacity of the central station plant will actually be used on the cars; the plant being such as can easily handle maximum loads of one hour duration.

Miscellaneous Facts.—In Cleveland schedule speed is nine miles per hour. We made ten miles an hour on the observation trips, including stops for a number of passengers, the length of route being 3.3 miles. In Scranton and Richmond schedule time is about six miles per hour.

Special tests limited to the exact time of a run, and made by daylight, do not measure all the power really consumed in car service. Lights at the station and on the cars, field circuits of shunt dynamos, movements of cars in yards, leakage and drop on the line; all these make their demand on the engines. Most of these additions are independent of grade, hence, as shown above, average car mileage per horse power hour in the station, and from bus line ammeter readings, will be found more uniform, as between different roads, than the trip determinations on the cars. Thus, from

\*Electrical World.



*Special Tests.*

Horse-power hours.  
per car miles.

Cleveland.....	0.67				
Richmond.....	1.05	= 50 per cent.	greater than	0.67	
Scranton.....	0.91	= 42 per cent	greater than	0.67	

*From Station Readings.*

Cleveland.....	0.9				
Richmond.....	1.18	= 31 per cent.	greater than	0.9	

The average expenditure of energy on cars, as shown in the special tests was:

	Watts.	H. P.	Total rise	Aver. speed.	
Richmond.....	4,883	6.5	8,500	55 feet	6, one way
Cleveland.....	4,986	6.6	9,500	0	9, round trip
Scranton.....	5,587	7.4	9,500	100 (?)	5.7, one way
".....	3,400	4.5	8,200	100 (?)	6.0, one way
".....	4,494	6.0	8,800	0	5.85, round trip.

Starting currents were generally 18 to 20 ampères, with about 460 volts at car. On grades, starting currents were 25 ampères.

The voltage at certain points was found as low as 325, due to bad ground connection, station voltage being about 475. At many points on the lines in Cleveland and Scranton 500 volts were recorded, voltage at stations being 505 to 525.

It is to be remembered that in all individual tests, equipped with motors of any kind now used, the handling of the variable resistance, whether internal, as in the commutated field of the Sprague Company's motor, or external, as in the Thomson-Houston motor, may produce results less favorable than the best possible results. An intelligent motor-man can save coal just as an intelligent driver of horses saves hay or horseflesh. The results given above involve the personal equations of average drivers.

**Cantilever Motor Truck.\***

This truck is so built as to prevent the oscillating motion of cars, and also to strengthen the ends of car bodies by providing additional support at each end. The main double side-bars which carry the springs, are upheld at their extreme ends by cantilever trusses. These are hung from the journal boxes by means of malleable iron yokes, to which the main side-bars of the truck are firmly united.

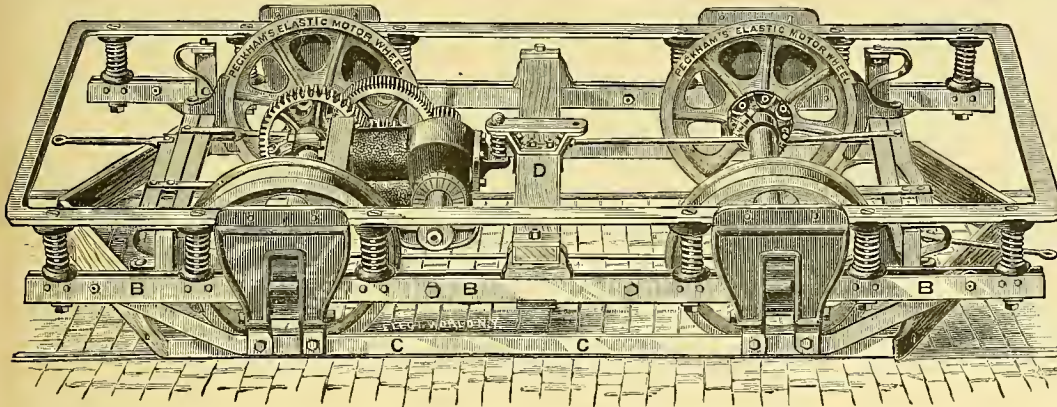

The motors are flexibly suspended as shown in the cut, and can be disconnected when desired, by the removal of only one nut. The center portion of the main side-bars can be easily taken off without disturbing the motor hanger, when it is necessary to remove armatures for repairs. The brakes are applied to all four wheels, and are controlled by compound brake levers that can be operated instantaneously and require but little power.

The wheels are provided with malleable iron hubs, which are forced on the axles at a pressure of thirty-five tons. The wheel webs are interchangeable, and can be renewed by any ordinary workman without the aid of special machinery and without removing the motors from the axles. Tubular rubber cushions are inserted between the hub and web. The trucks are equipped with Adams' dust tight journal boxes. The axles are constructed of fibrous steel and provided with large bearings and screw threaded collar.

The wheel base of the truck is six feet. The entire length is twelve feet. The car body rests on twelve springs, and it is claimed that this arrangement adds very materially to the easy riding of the car.

Messrs. Dorner & Dutton, of Cleveland, Ohio, who operate the street railway department of the Cleveland foundry, are building up a large trade, exceeding their expectations. In addition to the large part of the foundry set apart for their use, they have had to take in another building, 80x100 feet, and have fitted it up with the latest improved machinery for building motor trucks, journal boxes, wheels and axles.

\* Peckham Street Car Wheel and Axle company, New York.

**Banquet to Retiring Officers.**

On January 20th, a banquet was given by Messrs H. Mc L. Harding, special agent of the Sprague Electric Railway and Motor company, and J. L. Barclay, of the Sprague Electric Equipment company, to the retiring officers of the Sprague company at the Hoffman house. Among the gentlemen present were, Messrs. F. Johnson, E. H. Johnson, J. H. Vail, Samuel Insull, J. L. Barclay, H. Mc L. Harding, T. Hutchinson and J. Muir, of the Sprague company, C. W. Price, of the Electric Review, T. C. Morton, of the *Electrical World*, S. Dana Greene, late chief engineer of the Sprague company, and a representative of the STREET RAILWAY GAZETTE.

It was evident from the speeches that there was a universal desire to give credit to Mr. Johnson for the magnificent work done by him in connection with the Sprague company. The following address, read by Mr. J. H. Vail, now chief engineer of the Sprague Edison combination, certainly voiced the sentiments of the gentlemen present.

"The undersigned officers and employees of the Sprague Electric Railway and Motor company, upon your retirement from the presidency of this company, beg leave to present to you in this form an expression of their sentiments toward you, and their deep regret at your resignation.

"They realize that to your efforts, as much as to those of any one man, was due the birth of the Sprague company.

"Your keen foresight as to the possibilities of electric propulsion brought to this enterprise in its infancy, in large part, the business energy and the means wherewith its success was made possible.

"Your ceaseless advocacy of its merits and faith in its future were largely instrumental in establishing the public confidence it now enjoys. Under your administration the

business has been developed to its present great proportions, and the Sprague company, the pioneer in the problem of street car propulsion, placed at the head of that branch of American enterprise.

"A company which has derived such great benefit from your services can ill afford to lose them. Outside of this business aspect, we would add that each and all of us feel a sense of personal loss at your resignation.

"Not one of us but recalls the fact that your management has been marked by such candid criticisms of faults as to exclude the fear of secret dissatisfaction; while on the other hand, we recall instances of generosity, considerate kindness and interest in your personal welfare, endearing you to us by something more than mere business ties. You carry with you our hearts, as well as our confidence that success awaits you in whatever new enterprise may engage your energies.

"While this testimonial but feebly expresses the large and enduring admiration we have for your great business capacity and your eminent virtue, you are assured that your future will be ever followed by our sincere wishes for an unqualified success, and that, as long as memory endures, you will retain the grateful and affectionate regard of those who are proud to be named among your friends and business associates."

The address will be engrossed, and will bear the signature of the following named gentlemen: C. A. Benton, Frank J. Sprague, John S. Wise, J. H. Vail, Arthur S. Bevis, A. T. Starkey, J. H. McClement, Jas. Wiley, Wm. Rydler, Charles Hewitt, Theodore Beran, Geo. R. Metcalfe, Samuel L. Whitestone, Samuel Stein, C. T. Hamilton, A. S. Springstein, Wm. E. Mandelick, F. S. T. Branth, A. W. McClement, R. K. Case, H. W. Blake, H. T. Purdy, Patrick Shaughnessy, Wright Shaw, W. F. B. Rouquette, N. Ritchie, E. Dickson, M. Hormel, J. S. Murphy, H. D. Carter, M. Meinell, M. S. Adler, E. Elliott, C. W. Jenks, Whitney W. Monroe, C. F. Hannington, J. L. Barclay, D. C. Jackson, W. S. Kelley, H. F. Parshall, C. T. Hutchinson, W. H. Churchill, E. Whitestone, H. K. Browne, F. A. Mason, J. A. McLure.

The dinner was a very delightful affair, and was thoroughly appreciated by the gentlemen to whom it was tendered.

**Trolley Wire Insulator.\***

In addition to the unusual requirement of line insulators, viz., strength combined with high insulation, the insulators for the working conductor of an Electric Railway system, should be constructed to give rigidity in a line at right

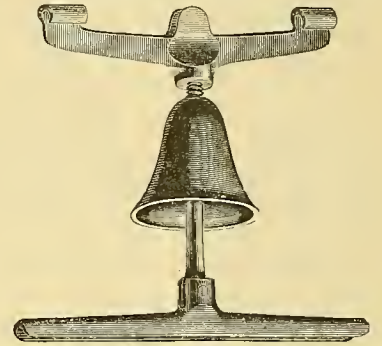

angles with the working conductor, and flexibility in line with the working conductor. The above points are claimed to be practically secured in this insulator and the ease with which it is placed in position, and removed either in part or as a whole, make it appreciated by Electric Railway constructors.

**Leather Covered Pulley †**

Heretofore, in covering pulleys with leather, it has been customary to drill holes in the face at each edge of the pulley and rivet the leather on, but in covering a pulley in that way it is impossible to keep the air from getting under and eventually breaking it out at the rivets. Besides, so many rivets being necessary to cover a pulley prevents the proper adhesion of belt to pulley and also cut out the belt. There can be no cement made that will perfectly fasten leather to an iron pulley; for the expansion and contraction of the iron will loosen it, and the covering is worse than useless without a perfect union with the pulley.

The Patent Pulley Covering here shown, being wider than the pulley face, its edges are brought over the edges of the rim and then turned towards each other and fastened on to a malleable iron segment clamps, with teeth to hold the leather; the clamps are placed around the pulley under the rim, and drawn together by a quarter-inch bolt, which draws the leather tight over the face and edges of the pulley. In this way, the leather can be drawn on the face of the pulley as tight as a drum-head, as the process of drawing is in a

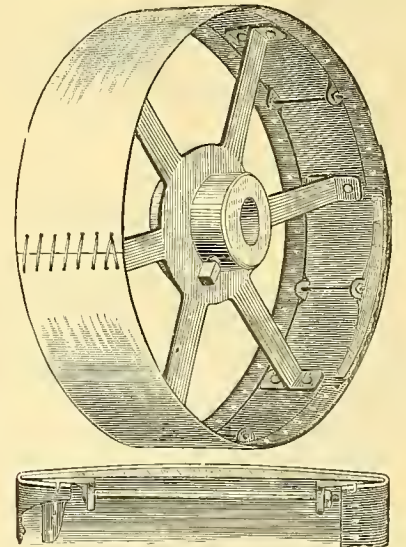

degree similar, and should the covering ever become loose, it can be tightened in a few minutes, simply with a screw-driver to turn the bolts.

It is claimed by the patentee that the pulley being so perfectly covered, the belt will wear much longer; that a leather covered pulley will drive fifty per cent more than an iron faced pulley; that belts can also be run slacker, thus preventing heated journals and wear on machinery.

\*Sprague Electric Equipment Co., Chicago.  
†Shultz Belting Co., St. Louis, Mo.



National Electric Light Association.

KANSAS CITY CONVENTION.

The annual convention of the National Electric Light Association will be held in Kansas City, commencing February 11th. The following is the programme as far as has been mapped out:

Mayor Davenport will welcome the Association and attending visitors to Kansas City.

President E. R. Weeks will open the Convention with a brief address.

Secretary and Treasurer Allen V. Garrett will make the usual reports.

PAPERS.

"Safety Devices in Electrical Installations." Professor Elihu Thomson.

Professor Rowland has consented to prepare a paper, based upon a correspondence with the members of the Association by the secretary, for the purpose of ascertaining the technical questions with which they find the greatest difficulty.

Mr. Thomas A. Edison will give an address—the subject of which is not yet announced—by phonograph, which will reproduce Mr. Edison's voice loud enough to be heard in all parts of the house. As but few persons have ever heard Mr. Edison speak in public, this address from the phonograph will be of unusual interest.

"Electricity as applied to Street Railways." Mr. Frank J. Sprague.

"The History and Theory of the Steam Engine." Mr. F. E. Sickels.

"The Economic Generation of Steam." Mr. George H. Babcock.

"Nine Years with the Arc Lamp." Mr. Myron D. Law.

"Line Insulation from the Standpoint of Practical Experience." Mr. C. A. Harber.

"A Universal System of Central Station Accounts." Mr. T. Carpenter Smith.

"The Cost of the Products of Central Stations." Mr. A. J. DeCamp.

"Central Station Construction." Mr. C. J. H. Woodbury.

"A Recent Edison Central Station and the Results thus far Obtained." Mr. C. J. Field.

"How Our Paths May Be Paths of Peace." Mr. Henry W. Pope.

"Prodigality in Economy." Mr. C. C. Haskins.

Mr. E. F. Peck, in the discussion of Mr. M. L. Law's paper, will give the results of his numerous tests of arc light carbons.

Papers from several other prominent gentlemen are looked for, and will be announced later.

REPORTS WILL BE MADE BY

The Executive Committee, Mr. G. W. Hart, chairman

Committee on Patent Legislation, Mr. Arthur Stewart, chairman.

Committee on Underground Conduits and Conductors, E. T. Lynch, Jr., chairman.

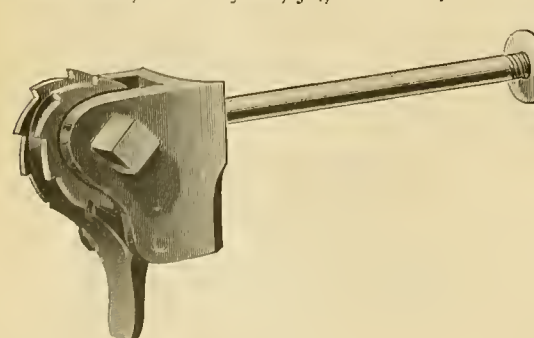

POLE RATCHET.

Committee on Harmonizing Electric Light and Insurance Interests, Mr. P. H. Alexander, chairman.

Committee to Confer with Mayor Grant in regard to the International Exposition of 1892, Dr. Otto A. Moses, chairman.

Committee on Electrical Data, Mr. A. R. Foote, chairman.

Committee to Memorialize Congress on the

Abolition of Custom Duty on Copper, Mr. C. A. Brown, chairman.

Committee on Electrical Execution, Mr. E. W. Maher, chairman.

Committee on Standardization of Potential on Electric Street Railways, Mr. E. T. Lynch, Jr., chairman.

National Committee on State and Municipal Legislation, Mr. A. R. Foote, chairman

Delegates and visitors will make their headquarters at the Coates House, while a number of them will be at the Midland and Centropolis Hotels. The officers of the association will be located on the second floor of the Coates House while the convention itself will be held in the Coates Opera House. It is expected that there will be held the finest exhibition of electrical appliances that has ever been got together by the association. The exhibit will be held in the Casino, which has an area of over 6,000 square feet.

The Kansas City Transfer company has the matter of putting exhibits in place in charge. Music Hall will also be impressed into service as an annex in the event of the space occupied by the exhibitors exceeding that of the Casino. Among the proposed exhibitors are the following named concerns:

Edison Machine Works; Sprague Electric Railway & Motor company; Phoenix Glass com-

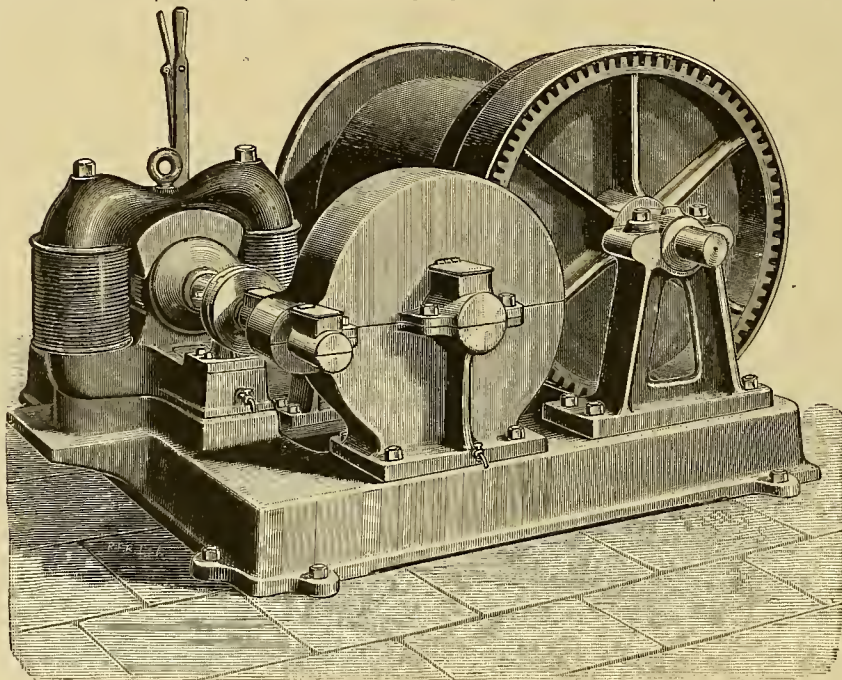

ELECTRIC HOIST FOR CAR HOUSES (SEE PAGE 21).

pany; Ansonia Brass & Copper company; Detroit Motor company; Weston Instrument company; American Electrical Works; Palermo Mica company; Eddy Electric Motor company; C. & C. Electric Motor company; National Electric Manufacturing company; Gate City Electric company; Okonite company; National Carbon company; Standard Carbon company; Charles D. Jenney & Co.; Charles A. Schieren & Co.; Royal Silk Manufacturing company; James W. Queen & Co.

We have received the following circular from the transportation committee:

CHICAGO, January 15, 1890.

The undersigned, Committee of Arrangements on Transportation, take pleasure in announcing to the Members of our Association that the Burlington Route, Chicago, Burlington & Quincy Railroad, has been selected as the official line to carry the delegates and their friends to the Annual Meeting at Kansas City, February 11, 12, 13 and 14.

A special Pullman vestibule train will be run through from New York City. This train will be lighted throughout with electricity, and at Chicago additional electric lighted sleepers will be added.

The solid train thus formed will leave Chicago Monday, February 10, 1890, at 5 P. M., arriving at Kansas City the next morning. Applications for sleeping car space in the special cars which are added at Chicago should be addressed at once to W. W. King, City Passenger and Ticket Agent, C. B. & Q. R. R., 211 Clark Street, Chicago.

RATES.

A rate of a fare and a third for the round trip, on the certificate plan, has been obtained, certificates to be signed by Allen V. Garratt. To secure the excursion rate, tickets going should be purchased at the regular one-way rate, for

which a special form of receipt will be given. On presentation of this receipt by the original holder within three days from the date of the close of the meeting, at the Burlington Route ticket office in Kansas City, return tickets will be sold at one third the regular fare, provided the receipt has been properly endorsed at the meeting by Mr. Allen V. Garratt, Secretary of the Association. On this basis the cost for the railroad ticket for the round trip from Chicago will amount to \$16.67.

If lower rates than those quoted above are prevailing to Kansas City at the time of this meeting, delegates can, of course, avail themselves of the same.

C. H. WILMERDING, Chairman,  
F. E. DEGENHARDT,  
W. A. KREIDLER,

Committee.

Upon arrival in Chicago, the delegates will be guests of the Chicago Electric Club, where they will be entertained at lunch. It is expected that the convention will be one of the largest ever attended.

Mr. W. S. Griffith, of Davenport, Iowa, who has been appointed general manager of the several street railways in which Dr. W. L. Allen is interested, has had considerable experience in the electrical field. For five years he was in the model and electric machine department of E. T. Gilliland in Cincinnati; for five years with the City and Suburban Telephone company of Cincinnati, from which point he went to Indianapolis as inspector of the Western Telephone Co., where he stayed for three years. In 1880 he

went to Decatur as general inspector and assistant general manager of the Central Union Telephone Co.'s exchange there. Four years later he was appointed general manager of the same, in which position he has remained up to the present time.

Mr. H. A. GLASIER, late Vice-President of the Jarvis Engineering Co., and now resident partner in Chicago of the firm of J. A. Grant & Co., 243 Franklin street, Boston, Mass., has opened an office in the Electric Building, 103 Adams street, Chicago. The firm makes a specialty of the McIntosh & Seymour engine, and conducts a general engineering business, including the complete equipment of steam plants. It installed the power station of the Albany (N. Y.) Electric Railway, and has secured the contract to do similar work for the Brooklyn Electric Railway, Brooklyn, N. Y.

Pole Ratchet.\*

The pole ratchet forms the attachment of the span wire to the pole and a means of adjusting tension on same, thus moving the working conductor either vertically or horizontally as may be necessary. The ratchets are also used on the guard wire supports to affect the result of keeping them taut and at proper height above working conductor.

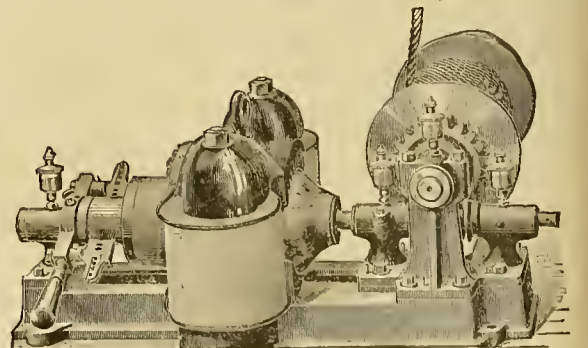

Small Electric Hoist.\*

In the accompanying illustration, a three horse power electric hoist is shown, which is very neat and compact; it is designed for light hoisting. The dimensions of these hoists, as shown in cut, are as follows: diameter of drum 6 feet; breast of drum 12 1/2 feet; revolutions of drum full load, 82; floor space required, 24 1/2 feet by 34 3/4; height over all 17 feet.

\* Sprague Electric Equipment Company, Chicago, Ill.



**Electric Hoist for Car Houses.\***

(See page 20.)

The growing and widespread attention which electricity is receiving from all classes, is especially instanced by the number of devices which are now placed upon the market for almost any kind of purposes; especially for street railway purposes, the distribution of power from street railway power houses, and mining.

In figure 1, we show a new electric hoist recently placed upon the market, which hoist embodies all the latest improvements in this line of machinery, and is adapted to all general hoisting purposes. The best quality of material is used in its construction, the motor is of the very latest type, and it is claimed by its inventors that its record for economy, reliability and efficiency is very high. It is very compact, light in weight and powerful in operation. The form or friction drum used is one that is well known; the friction being one of the double cone type and composed of sectors of thoroughly seasoned hard wood, bolted to the spur wheel and turned off to suit the flanges of the drum with which the surfaces engage when in gear. These drums are very durable, as is demonstrated by the fact that one of them has been in constant use for several years without requiring renewal. The cut shows a standard style of foot brakes which are wood lined, the blocks being fastened to the band by lag screws. The band is made in two pieces,

energy. He noticed from the fact of its mobility, that one motor, mounted as shown in the illustration, accomplishes the work of three ten horse power stationary engines; each cutter thus operated giving ten tons of coal per hour, from soft bituminous to the hardest anthracite, without gas, smoke or dust, thus doing the work of at least ten men, with practically no danger to the men or the machinery, and with infinitely greater economy.

We also witnessed an operation of one of these cutters in the same state where it struck what is known as a "horse" in the vein, composed of slate, sand and sulphur, making a very hard rock conglomerate; the machine cut its way right through the same, which was two feet thick and three feet in width, and it only required ten minutes for the operation. It certainly would have required the work of two miners with picks for over an hour to have freed the vein from the obstacle.

**Stationary Motor for Distributing Power.\***

We notice that in a majority of cases a great many of the street railways now being incorporated are organized for the purpose of not only operating street railways, but with a view of selling power to manufacturers; in view of this fact we believe it to be of interest to our readers to show herewith a cut of a stationary motor, for which it is claimed by the inventors that its first cost is over twenty per cent. less than that of any other manufacturer. There are but two parts of the machine exposed to wear, and depreciation, according to the records, is very slight. We have known one of these motors which has been running day and night in Pittsburg for over six months without a stop. There is no sparking on the motor, due to the neutral point being held fixed under the brushes, and not changing from variation in load, all of which

**Incandescent Lamp for Electric Cars.†**

The introduction of electric propulsions for street railway purposes, has resulted in beautifying improvements on car bodies, particularly the interior finish. The decorations are such as would have been used in a sleeping car or a pri-

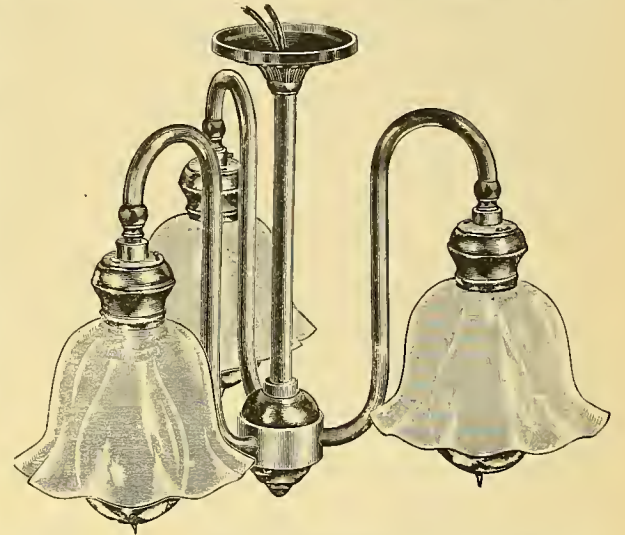

vate car some two years ago, are now common in our street cars. The decorative effect in lighting has also been made possible since the introduction of electricity, until now we find cars fitted with incandescent lamps and handsome fixtures. We find on the platforms of cars, a lamp giving light to facilitate the unloading and loading of passengers. Inside the car we find four or five lamps arranged separately along the ceiling, sides, or in a cluster in centre of car. One of the latest and handsomest fixtures for the interior of cars has just been placed upon the market. A cut of which is shown herewith. It is made of polished brass or gold bronze, the design is such that the lowest point of the lamp does not come below the lowest part of the fixture. The three arms radiating out from the centre are gracefully curved, making it possible to use a shade on each arm. The shade used on the fixture illustrated is of opalescent glass. Sixteen candle power lamps are ordinarily used, but any desired candle power can be inserted in the sockets.

**Western Electric Railway Association.**

Several gentlemen, including Dr. W. L. Allen, of Davenport, Iowa, W. R. Moore, president of the Moline Central Street Railway company, W. L. Ferguson, general manager of the Citizens' Street Railway company, of Decatur, Ills., and G. E. C. Johnson, president of the Lafayette Street Railway company, met at the Grand Pacific Hotel, in Chicago, on the 29th ultimo, to hold the first semi-annual convention of the Western Electric Railway Association. Owing to the absence of the President, Mr. T. J. Evans,

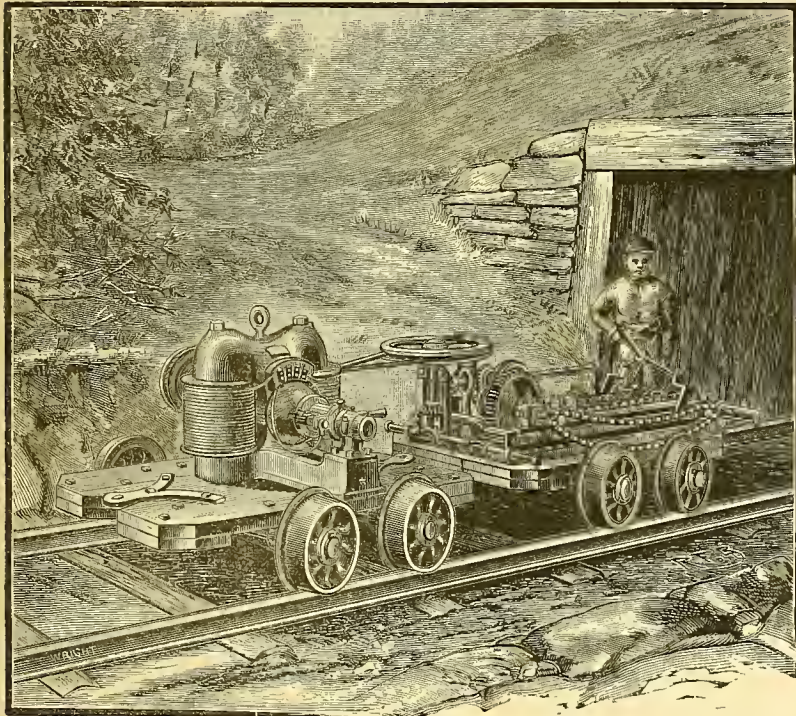

ELECTRIC COAL CUTTER.

connected by a bolt with jam nuts on the end so that it can be easily and quickly adjusted to take up the wear, etc. It is fastened to the fixed guard over the gear wheel by means of a lug, which holds the brake off the drum flange when not in use. The foot lever is counter-balanced by a movable weight as shown in the accompanying sketch. These brakes have great power, so that with a reasonably moderate pressure any load the motor can hoist can be held without difficulty. The motor, as shown in this illustration, is of 15 horse power, and the dimensions are as follows: Size of frame, 54x58½ inches; height of hoist, 45 inches; diameter of drum, 23 inches; length of drum, 27 inches; speed of drum, 46 revolutions per minute; weight of hoist and motor complete, 5,161 pounds. It is geared down to 1 to 25, and will raise 16 to 1,700 pounds at a speed of 228 feet per minute.

It is unnecessary to state that hoists of this kind become almost a necessity in many car houses.

**New Electric Coal Cutter.\***

When in Pennsylvania lately a representative of the GAZETTE saw an operation at the Himes Colliery where a Sprague electric motor mounted on a truck, as shown in illustration, operated a Stine-Smith coal cutter twenty or thirty feet away. This serves as an illustration of the advantage of having such a moving source of

adds considerably to the life of the motor. The speed of the armature never varies, while the circuit furnishes just what energy is needed, and only what is used; this being an advantage which enables producers and suppliers of power to supply it at the least possible expense, and take complete advantage of intermittent use. These motors, as general distributors of power, are absolutely harmless, both to human life and to property; and at the same time they are as neat and noiseless as the best made sewing machine. Electricity thus transmitted, has great advantages over steam, water, gas, compressed air or wire rope. Its system of conductors is far more flexible in its arrangements, and is capable of a far more ready ramification and distribution than any other source of power. It is operated under high pressure, and can thus be distributed with small conductors and a minimum of investment of time, labor and money.

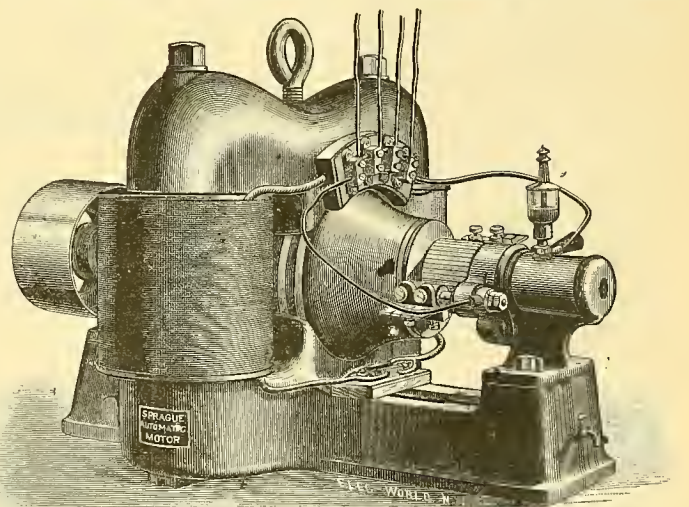

STATIONARY MOTOR FOR DISTRIBUTING POWER.

of Omaha, who is in California, and a number of other members, only an informal meeting was held. Some committees were appointed and the convention adjourned until the 11th of June.

\*Sprague Electric Railway and Motor Co., New York and Chicago.

† Sprague Electric Equipment Co., Chicago.



### New Star Lamp Burner.\*

In the accompanying illustration it will be seen that the burner is provided with an automatic extinguisher, which puts out the light completely when the wick is turned down below the mouth of the wick-tube, thus saving all risk of danger from blowing out a kerosene lamp, and also the annoyance of the consequent unpleasant odor, besides having the advantage of keeping the wick level and even.

The burner is provided with a superior hand-burnished cone, thus producing a large and beautiful flame.

It appears to be admirably adapted for street railway cars, where a kerosene lamp is used, and is a perfectly safe burner to use.

### George B. Kerper Resigns.

At the 18th annual meeting of the Mount Adams and Inclined Railway company, which was held here on the 21st of January, Mr. George B. Kerper, formerly president of the company, handed in his unconditional resignation as president and director of the company. For some time past it has been generally understood that Mr. Kerper had about made up his mind to withdraw from active dealings with his company, owing to internecine difficulties, and the matter was probably expediated owing to internecine difficulties with the board, especially between himself and Mr. John E. Bell. Mr. Kerper's annual report to the stockholders is as follows, and is certainly characteristic of the wit for which this gentleman is noted, and was likewise characteristic of him to have a good word for those who stood by his company in its progress and sympathized with it during its troubles: "The annual statement of passengers carried, the earnings for the year with comparisons for the past five years and the financial statement of the company are before you. The radical change made for the future good of the company May 1, 1887, by reducing the fares to a uniform rate of five cents, was a reduction of 13-10 cents per passenger on a daily average of 14,000 passengers, making a total reduction of over \$6,000 per annum. Notwithstanding this great loss, and through it the heavy burden it placed upon the management for the past two years, by strict economy the increase of traffic enabled us to pay the dividends. For the future this loss will not be felt, being overcome by the large, permanent increase of the business. It demonstrated that the progressive policy of the company in making an outlay of over \$500,000 in the construction of the Gilbert avenue cable line and following it with this reduction of fares, was the correct policy to pursue. It gave to Walnut Hills renewed life, and the tide of population went there while other suburbs surrounding the city suffered, all for the want of low fares and proper facilities. It gave to this company increased travel from the thousands who permanently located on the line of the cable road. At the time we secured the cable grant we procured a number of extensions, among them McMillan street, the Madison pike, and last year the Montgomery pike to Norwood. Early last spring some opposition manifested itself before the Board of Public Affairs and with the people of Walnut Hills. We were asked to define our position, which we did by pledging ourselves to build all extensions by the close of 1889. We are in default on these promises from the fact that I was not authorized to fulfill them. This, with other good reasons, makes my duty plain, and, while I sever my connection with an enterprise that I became identified with from the date of its inception, fifteen years ago—at which time it was predicted by every one except its projectors, that the project would prove a total failure—yet I retire with much pleasure, from the fact that I retain my self-respect and turn over to you the property of the company in a prosperous and growing condition, with a great future before it. I foresee in my retirement a closer relation with the management of the Cincinnati

St. Ry. Co. "This will prove beneficial to your interest and that of the patrons; but to reap the benefit you must continue to be progressive, and build the extensions for which your pledge has been given. Do this promptly, and within five years you will be carrying double the number of passengers you carry to-day. I refer you to my October report, made to the Board of Directors, in which I outlined what the Chicago City Railway company had done by just such a policy. Your franchises speak for themselves. By establishing a reputation of good faith—carrying out to the letter every promise we made—we obtained liberal grants, which are of great value to you and of great benefit to the people who own property in the territory occupied by your lines.

"During the fifteen years we have operated, we have had a large number of damage suits brought against the company for injuries to individuals and damages to property. The records of the court show that up to date we have never paid a

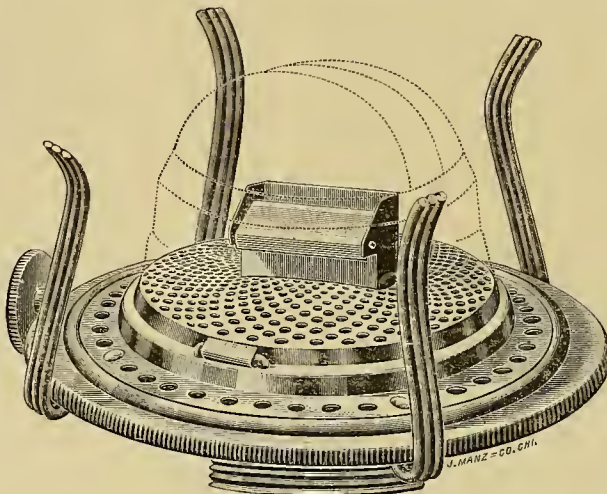

STAR LAMP BURNER.

dollar in this direction, except where we recognized the obligation and made an amicable settlement. This is a handsome record, and the credit for the same is largely due to the attorneys of the company.

"I commend to you the faithful men we have in our employ, a large number of whom have been in the service of the company for many years, all of whom have stood by us in our strikes and sympathized with us in all our troubles. They have been taught to feel that the reward of merit came to those who faithfully served your interests. They extend to you their good will, and will serve you faithfully under whomsoever you may select as my successor.

"My acts are recorded. I return my thanks to the stockholders, the patrons, the employes, the city officials, the press and all with whom I have had business relations for the many courtesies shown me, and for the many favors I have received at their hands.

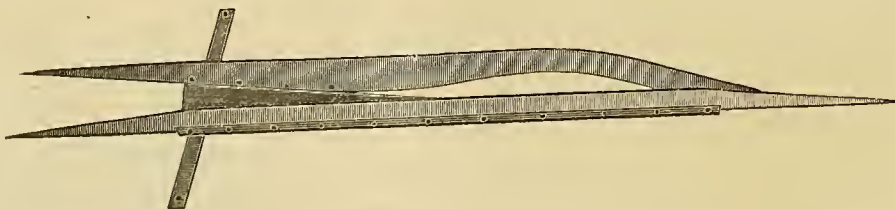

ATKINSON OVERHEAD SWITCH.

"To those of you (and I think this includes nearly all) who do not know the great responsibilities, troubles and daily worryment that falls on the management of this enterprise, I ask to join in extending to my successor our warmest sympathies. Treat him liberally, and give him your cordial and hearty support. Make his life a bed of roses on the inside, as he will find sufficient thorns without. My private telephone line will be turned over to him, and you should furnish him with a magnificent couch to enable him to recline within call of the many emergencies that will require his prompt attention. As I retire from the volcano I trust that he will come out of your service at the end of the next fifteen years (after having been blown up as many times as I have been) with as good capacity for enjoyment, and with as much happiness left to him as

I have in sight; then he can thank you for his election, as I most heartily do for my fifteen successive terms and for the just reward which now is mine, and which I believe I have honestly earned."

### Kirchner's Cable System.\*

Companies or contractors about to build cable roads would do well to carefully examine, not only the old systems, but some of the new ideas almost daily brought before the public and the subject of a large number of patents, most of them tending to the one idea of lowering the cost of construction, while a few are especially aiming at considerable reduction in the cost of general maintenance; both of which have hitherto cost enormous sums; so great indeed as, in many instances, to entirely prevent the adoption of cable roads in small cities or in places where the population is scattered over considerable distances, so far as concerns the construction, a very large portion of the outlay is necessitated by having to build a wide and deep conduit, to carry the rope and its attendant pulleys and with sufficient space for the free passage of the grip, which in the maintenance of the road, a large portion of the expense is due to the constantly recurring fact of replacing worn out cables by new ones. As to the wear and tear of the cable, of course a considerable amount of that is due to unavoidable friction, as it runs over the various carrying pulleys, in its way, but another and possibly an avoidable cause is due to the heavy friction caused by the rope having to run through the grip the whole time the car is stationary. With the grip in ordinary use, which is made to seize the cable from below, or the side, this difficulty can not very well be overcome, but by an entirely new arrangement, which has been laid before us, and which is the object of a patent, not only is this overcome, but we are informed that the whole cost of construction of the road is reduced to probably one half. The grip itself is described as adjustable, and is so designed that instead of seizing the cable from below it seizes it from above, only so that immediately on its release, the cable falls clear and free, and, of course, entirely out of the way of any friction or wear due to the grip. This, however, is not the only point claimed by the inventor for his system, as, by its use, other difficulties are removed without in any way adding to the primary cost of installation; amongst these may be mentioned the fact that it is made so as to cross other roads without requiring the attention of the gripman, and it will also pass from one road to another without any delay, and without necessitating the use of horses.

### Atkinson Overhead Switch.†

The Atkinson Switch, of which the illustration is a fac simile, has solved a difficulty which has long been a source of trouble in the operation of the cars on a single track with turnouts.

In the early stages of electric railroading, the overhead wire was, as now, made to diverge at the switches, the point of divergence being thrown well inside the track switch point, and depending on the pull of the car to throw the trolley on to the proper wire. Later a species of blind switch was used, consisting of a metal shoe, and also depending on the pull of the car to guide the wheel. The chances were about even which wire the contact wheel would take, and vexatious delays were caused by this difficulty. The Atkinson switch is positive in its action and invariably guides the contact wheel to the same wire. It can be set to direct the wheel either to the right or to the left in order to suit the rail turnout, and can be placed at any point within ten feet of the diverging point of rail switch. A valuable feature is the fact that it is placed in position after the contact wire is entirely put up, and can be removed and replaced at any time without disturbing the contact wire.

\* N. Kirchner, Philadelphia, Pa.  
† Sprague Electric Equipment Co., Chicago.

\* Stickney & Gillette Mfg. Co., Chicago.



**Street Railway Associations.**

OFFICERS, DATES OF MEETINGS, ETC.,

**AMERICAN ST. RY. ASSOCIATION.**

President, Thomas Lowry,.....Minneapolis, Minn.  
 First Vice-president, C. Densmore Wyman,....New York  
 Second Vice-president, J. C. Schaffer,.....Indianapolis, Ind.  
 Third Vice-president, Robert McCulloch,....St. Louis, Mo.  
 Secretary and Treasurer, Wm. J. Richardson...Brooklyn

**EXECUTIVE COMMITTEE.**

The President, Vice-Presidents, and  
 Geo. B. Kerper,.....Cincinnati, O.  
 Geo. W. Kiely,.....Toronto, Can.  
 R. Semmes,.....Memphis, Tenn.  
 F. H. Monks,.....Boston, Mass.  
 Francis M. Eppley,.....Orange, N. J.

The annual convention of the Association will be held at Buffalo, N. Y., commencing on Wednesday, Oct. 15, 1890.

**N. Y. ST. RY. ASSOCIATION.**

President, John N. Partridge,.....Brooklyn  
 Vice Presidents, Daniel B. Hasbrouck,....New York  
 P. B. Brayton,.....Syracuse  
 Secretary and Treasurer, William J. Richardson, Brooklyn  
 The annual meeting of the Association will be held in Rochester on September 16, 1890.

**MASS. ST. RY. ASSOCIATION.**

President, Chas. H. Odell,.....Salem  
 Vice-Presidents, H. M. Whitney,.....Boston  
 Amos F. Breed,.....Lynn  
 F. O. Stearns,.....Swansey  
 Secretary and Treasurer, J. H. Eaton,.....Lawrence  
 Regular meeting day, first Wednesday in each month.

**THE ST. RY. ASSOCIATION OF THE STATE OF NEW JERSEY.**

President, John H. Bonn,.....Hoboken  
 Vice-President, S. S. Battin,.....Newark  
 Secretary and Treasurer, Charles Y. Bamford,....Trenton

**EXECUTIVE COMMITTEE.**

John H. Bonn,.....Hoboken  
 S. S. Battin,.....Newark  
 C. Y. Bamford,.....Trenton  
 C. B. Thurston,.....Jersey City  
 John Hood,.....Camden  
 A. Q. Keasbey,.....Elizabeth

**OHIO STATE TRAMWAY ASSOCIATION.**

President, Wm. B. Hayden,.....Columbus  
 Vice-President, John N. Stewart,.....Ashtabula  
 Secretary, A. E. Lang,.....Toledo  
 Treasurer, J. B. Hanna,.....Cleveland

**EXECUTIVE COMMITTEE.**

Ross Mitchell,.....Springfield  
 The annual convention of the Association will be held in Columbus, O., on November 19, 1890.

**WESTERN ELECTRIC RAILWAY ASSOCIATION.**

President, T. J. Evans, Council Bluffs, Ia.  
 Vice-President, H. E. Teachout, Des Moines, Ia.  
 Secretary, W. L. Allen, Davenport, Ia.  
 Treasurer, W. R. Moore, Moline, Ill.  
 Next meeting will be held June 11, 1890.

**West Division Loop Power Station.**

The loop station of the Madison street cable road, located at the northwest corner of Jefferson and Washington streets, Chicago, will be completed and in working order in a very short time. There are two Wetherell Corliss horizontal engines with cylinders 28 inches by 60 feet, connected to one driving shaft by clutch couplings. The engines will run at 65 revolutions, and are capable of developing 500 h. p. each. Rope belting will be used to transmit the power in preference to gearing, as is the usual practice in cable stations. There will be 24 ropes, each of 3 inches diameter, and running in separate grooves from a driving drum 7 feet 6 inches in diameter to a similar drum 27 feet in diameter on the shaft which drives the cables. The use of this arrangement for driving is preferable to gearing, on account of less noise in its operation, and, as is claimed, it is less costly to install and more economical to maintain. Another point claimed in its favor is that it prevents a complete break-down, as occasionally happens in the use of gearing, for if one tooth breaks the plant is disabled until repairs can be made, which is always an expensive matter. With rope belting, when arranged in this manner, which always provides a surplus of strength, if a rope should break no delay is necessary, for the remaining ropes are capable of carrying the load until the machinery is stopped at midnight, when it can be repaired in a short time. It is said that a plant similarly arranged has been in successful

operation in Denver, Colo., for some months, and no difficulties have been experienced in the use of ropes in this manner.

Behind the engines and about 16 feet below their level, the electric light machinery will be located. This will consist of two Russell automatic high speed engines 12x18 inches, connected to one shaft by clutch couplings, and driving four dynamos. Rope transmission will be used. There will be three Sperry 30 light arc dynamos and an Edison dynamo at 90 lamps capacity.

The electric light plant is being installed by the National Electric Construction Co., Chicago. At the rear of the building, on the same level with the electric light machinery, but separated from it by a heavy brick wall, is the boiler-room, which contains six boilers 60 inches by 16 feet, and arranged in two batteries of three each, but with ample provision for connecting all together if necessary. For feeding the boilers there is a duplex pump of ample capacity and two inspirators. The pump feeds into a large vertical heater using exhaust steam. The exhaust after escaping from the heater, is led through a separator, which retains the water and the steam, and is then carried into the stack. Taken altogether and judging from present indications, the plant, when finished, will compare favorably with, if it does not excel, all others in the western country.

**Decision by Judge Bundy.**

WISCONSIN TELEPHONE COMPANY vs. EAU CLAIRE STREET RAILWAY COMPANY AND SPRAGUE ELECTRIC RAILWAY AND MOTOR COMPANY.

State of Wisconsin, Eau Claire County, ss. Circuit Court of Eau Claire County.—

This is a motion for a temporary injunction to restrain the defendant from operating their electric railway in the streets of Eau Claire, for the reason, it is claimed, that the escape of electricity from the wires of the defendant's road interferes with the successful operation of the telephone of the plaintiff. It is claimed by the plaintiff that the leakage of the electricity complained of is occasioned by the failure on the part of the defendant to erect suitable wires for the return of the electricity, instead of allowing it to escape through the wheels of the car and thence return by the railroad track. The railroad in question was duly authorized by the city authorities and has been in operation, as a horse railway, up to the present winter. The plaintiff company have operated their telephones within the city and along the streets parallel with the street railway for several years,—since 1882. During the present winter the defendant company changed their power from animal power to electricity, and for three months past have been using the last named power.

The principal use of the street is to accommodate the traveling public and whatever rights the telephone company have must be held to be in subordination to this right of travel. They must so conduct their business as not to interfere with ordinary travel and they must submit to any necessary inconvenience resulting from the ordinary travel passing over the street. They take their rights subject to this burden. This principle applies not only to the mode of travel at the time the telephone was built and their rights acquired, but applies as well to any new or improved modes of travel which may have been or may hereafter be invented and applied generally in aid of travel on the public streets. But the plaintiff company has the right to demand that those passing along the streets, either with vehicles or with electric cars, or any other mode of travel, shall exercise reasonable care. They must be guilty of no negligence, they must adopt all the usual, reasonable and necessary safeguards to prevent accident or injury to the property or rights of others. If they do this and notwithstanding such care the plaintiff is subjected to inconvenience it must be borne by it. The evidence in this case satisfies me that the defendant has been guilty of no negligence either in the building or operation of its road.

The system adopted by the defendant is one in common use. The evidence clearly shows that what is known as the single trolley system, by which the electricity returns by way of the wheels of the car and the track, is now used by nine-tenths of the roads in operation in the United

States; that the double trolley roads which adopt the plan of a return wire, have in some instances been built; but the evidence of all the experts is to the effect that they are practical failures; and the evidence fails to show that any scheme has been invented which is practicable and can be made a success, except the system adopted by the defendant in this case, that is the single trolley system. Hence it follows that they have been guilty of no negligence, and as it is further true that the system adopted is substantially the only one upon which can be operated successfully, it follows that the prayer of the complainant asking for an injunction to restrain the running of the road as it is, by compelling it to adopt some other or different means, is, in effect, asking for an entire cessation of the use of the defendant's road as an electric road. I am not prepared to do that.

The defendant has been subjected to considerable expense and has just got the road in successful operation, without any objection, as the evidence shows, on the part of the plaintiff company, and it would be a hardship now, and virtually destroy their property, to grant the injunction prayed for.

On the other hand if I deny the motion the telephone company can continue the use of their lines. This is amply proved by the undisputed evidence of the experts in this case. It appears beyond question that a way has been contrived, by which, by means of a return wire, forming a metallic circuit, they can operate their plant successfully, without injury from the escape of the electricity complained of. With them it is not a question of total suspension of business, but simply a question of expense of alteration, and so far as the evidence appears I should conclude that the expense would not be a very considerable amount.

Hence the injury complained of is not irreparable or continuous.

When the improvement is made the trouble complained of will cease and the plaintiff, if it should be found that this expense so incurred was made necessary by the wrongful act of this defendant, could sue the defendant at law and recover whatever expense was incurred in making the change.

I therefore think that if the plaintiff has suffered any injury by the acts of the defendant in building or in operating their road, it has a complete remedy at law.

The plaintiff claims that it is entitled to this injunction under chapter 375 of the Laws of Wisconsin for the year 1889; sections one and two of this statute read as follows:

Section 1. It shall be the duty of each and every electric light and power company and of each and every person engaged in the transmission of electrical energy within this state to provide, by suitable insulation, return wires or other means against injury to persons or property by leakage, as escape or induction of any and every current of electricity.

Section 2. Neglect of any of the above provisions shall entitle the person or corporation injured thereby to a preliminary injunction, preventing further use of such current until said section one has been complied with.

It appears to me that the language of this statute is broad enough to cover the case of the plaintiff as well as that of the defendant. The object of this statute is to prevent leakage from electric wires permeating the earth and causing damage to others, and by its terms as clearly forbids the plaintiff from allowing the electricity to escape into the ground as it does the defendant, and hence if I am right in this it follows, that even if the defendant was in the wrong in not providing for a safe return of the electricity, that the plaintiff is just as clearly in like position, differing only in the amount of electricity that is allowed to escape. And the evidence in this case shows that but for the unlawful act of the plaintiff, in using the ground for a return circuit contrary to the provisions of the statute, no serious inconvenience would result from the proximity of the defendant's wires, and the plaintiff, being in the wrong, and suffering damage, in part at least, by reason of its own wrongful act, is not entitled to an injunction.

Signed,

E. B. BUNDY, Judge.



# The Street Railway Gazette.

S. L. K. MONROE, - - - - - MANAGER.  
E. V. CAVELL, - - - - - EDITOR.  
EDWARD J. LAWLESS, - - - - - ASSOCIATE EDITOR.  
W. L. S. BAYLEY, - - - - - MECHANICAL EXPERT.

## GENERAL OFFICES:

### CHICAGO:

8 LAKESIDE BUILDING.

AGENCIES } San Francisco, - - - 1222 Bush Street.  
} Toronto (Canada), - - - 53 Magill Street.  
Cable Address=TRAM, CHICAGO.

### Annual Subscription (Including Postage).

	Per Copy
United States, Canada.....	\$2.00. 25c.
Great Britain, Ireland, India, Australia	10s. 1s.
Germany.....	9mk. 75 pf. 89pf.
France, Belgium, Switzerland.....	21fr. 95c. Fr 1.10.
Spain.....	21ps. 95c. Ps 1.10.
Austria, Holland.....	6fl. 74c. 55c.
Italy.....	12 lire. 1½ lira.
Venezuela.....	12 bolivars. 1½ bol.
Mexico.....	\$3.00. 30c.

Annual Subscriptions in Argentine Republic, 2½ peso; Brazil, milreals; Turkey, 54 plasters.

[Entered at the Chicago post-office as second-class matter.]

\*.\*

Matter for publication should reach the Chicago Office not later than the last day of each month. All communications should be addressed, THE STREET RAILWAY GAZETTE, Chicago, Ill.

## Electric Railway Association.

Regarding the recent meeting of the Western Electric Railway Association, we can not help expressing the opinion that a greater interest should be shown in this association by electric street railway men, not only by the officers of western roads, but also by those in the east. The objects sought to be accomplished by this association are certainly of a nature to commend themselves to all who are in any way interested in electric street railway enterprises.

The primary object of the association is to effect interchange of experiences in what is, practically, a new field, and regarding which but very little is known by the majority of men. It is one thing to operate a mule bob-tail line, and quite another thing to operate with equal success and increased prosperity a line equipped with the new motive power. We do not mean to intimate by this that there are not a great many gentlemen, who have adopted electricity as a motive power on the lines owned by their companies, who understand the electric railway business, but what we do assert is, that it is impossible, or next to impossible, for any ordinary railway man, be he president or superintendent, to jump all at once from animal to electric traction, and to know as much about the latter at once as he learned about the former in passing through the experience of a number of years.

It appears to us that the policy of this Western Electric Railway Association should be to leave no stone unturned to get the officers of electric railways in all parts of the United States thoroughly interested in the work it aims to accomplish, and bring all possible influences to bear upon them to permit the *practical* men of their companies, whether superintendents or general managers, to attend these conventions and reap the benefit of the experience of others in the same field. That there is ample room in the field for an association of this kind can not be denied, and because it is organized separate and distinct from any other, it must not be understood that it is the desire of its members to conflict in any way with the American Street Railway Association. We have good reason for be-

lieving that a feeling once existed among some gentlemen prominently identified with the A. S. R. A., that the Western Electric Railway Association was intended to be somewhat in opposition to their association. But this was before the annual convention of the A. S. R. A. in Minneapolis, and the regular meeting of the W. E. R. A. held in the same city. Now that the objects of the W. E. R. A. are better known, we think that the feeling has died out, and that nothing but the best interests, affiliation and co-operation is desired by the western men.

When the A. S. R. A. was organized, such a thing as the use of electric power for the propulsion of street cars was not seriously thought of as a factor in street railway business, but within the last few years, however, it has been generally adopted, and to-day almost two hundred street railways are using electricity as motive power. It certainly appears to us that the gentlemen connected with electric interests, and having but little interest in animals as motive power, would be doing a wise thing in getting together at least once or twice a year—without regard to other associations—and discussing among themselves ways and means for a better and more economic operation of their cars by electricity, and by these meetings or reunions be benefitted by the experience of those who have become practical men by having been through the mill.

A number of the members have expressed the opinion that it might be advisable to drop the first word of the corporate name of the W. E. R. A., in order that it may thus announce itself as the Electric Railway Association of America, and thus largely increase its sphere of usefulness.

## Street Car Companies and Storms.

An attempt on the part of the city of Los Angeles to punish the officers of the cable company for their zeal in the protection of their power house by cleverly diverting the current, during the recent flood in that city, seems to us to be an act savoring strongly of the ridiculous. The ground taken by the city it appears to us, is that one street is the natural water course of the city, and that others are not.

Nearly two and one half million dollars have been invested in Los Angeles by the Pacific Cable Railway company, and it has not only the highest *moral* right, but in our opinion, an indisputable *legal* right to protect its magnificent machinery, to the utmost of its power, from the flood just as much as it would from fire. Had the company not exerted the most strenuous efforts and turned the course of the water from one of its power houses, the damage it would have sustained would have been simply enormous.

As far as we can learn, not one single citizen whose property was destroyed, by reason of the company diverting the course of the torrent from its power house, has entered a complaint. It appears to us to be a narrow-minded attempt to prosecute the cable company or to blackmail it into constructing storm drains for carrying off surplus water.

We can not help watching with pardonable curiosity the further action of the corporation of Los Angeles in this matter; and it would hardly surprise us to learn that it has passed an ordinance compelling the cable company to erect buildings on old vacant lots along its line, and to plant shade trees along the route because property owners may have neglected to do so. At this long range, and having a lively recollection of the situation and location of Los Angeles, it

looks to us that the cable company should rather sue the city for damages on account of defective drainage, instead of the city trying to put the boot on the other foot.

## Another Victory for the Overhead System.

In another column we give in full the decision rendered by Judge Bundy of the Circuit Court of Eau Claire County, Wis., in the matter of the temporary injunction asked for by the Wisconsin Telephone company against the Eau Claire Street Railway company and the Sprague company, to restrain the defendants from using the overhead system in the operation of its cars. The plaintiff claimed that the defendants failed to provide suitable insulation, return wires, or other means to prevent injury to persons or property by leakage, escape, or induction of the currents of electricity, as provided for in an act passed by the last Legislature, and that neglect of this act should entitle the parties injured thereby to a preliminary injunction until the requirements had been fulfilled. Judge Bundy's opinion embraces the following points: That the principal use of the street is for the traveling public, to whose rights those of the telephone company are subordinate; that this principle applies equally to all modes of travel established since the telephone system was put in; that the single trolley system of street railway, by which the electricity returns through the track, is of reasonable perfection; that the few double trolley roads which have been built, in which the currents return over a second wire instead of the track, have been practically failures; that proprietors of single trolley roads are thus guilty of no negligence whatever, because this system is the only successful one; that plaintiff's demand for an injunction if granted, would compel an entire cessation of the use of the defendant's road as an electric line, and virtually destroy the property; that the telephone company can use a return wire to obviate leakage and induction, and it is simply a question of inconsiderable expense, which, if shown to be due to wrongful acts of defendants, is recoverable from them; that but for the unlawful act of the telephone company in using ground wires no serious inconvenience would result from the proximity of defendant's wires. Thus the telephone company's own law was used as a club to pound it out of court. The decision, which is applicable to single trolley systems all over the country, has been watched for with great interest in eastern cities where similar cases are pending and it has resolved itself into another decided victory for the overhead system.

It is not generally known that Mr. John A. Brill of Philadelphia recently had in his possession two of the most valuable stamps in the United States. They were nothing more nor less than two of the original stamps engraved in England for use in the American colonies in accordance with the provisions of the stamp act of February, 1765. Their denominations are a penny and a half-penny, and they came into the possession of Mr. Brill through his friend Mr. E. J. Walker, of Newcastle-on-Tyne, England. Very soon after the stamps came into his possession Mr. Brill received an offer of £10 from an English collector for the two, but declined it at once, whereupon the Englishman cabled him an offer several times as large, which was also declined. Mr. Brill came to the conclusion that if the stamps were of that much value to an Englishman, they would be of much more interest to an American museum of historical relics, and he promptly presented them to the National Museum here, where they will be appreciated and properly preserved.



## LEGAL DECISIONS.

## COURTS OF LAST APPEAL.

THE RIGHTS OF EMINENT DOMAIN HELD SUPERIOR TO PROPRIETARY RIGHTS. GRANT BY CITY COUNCIL TO ONE COMPANY TO USE THE TRACKS OF ANOTHER. *Canal and Carondelet Street Railway company v. Crescent City Railway company*; Supreme Court of Louisiana, May 1889, 6 South, Ry. 849.

McENERY, J. This is a suit to recover from the defendant company the value of the use of the street-railroad tracks of the plaintiff, on Canal street, from its terminus, on Canal street, near the levee, up the north side of Canal street to Carondelet; and from the intersection of St. Charles street, both the Canal street tracks on the south side of Canal street to the terminus, near the levee; total length of track, 3,900 feet. Compensation is claimed from September 8, 1881, the date the defendant company commenced using plaintiff's track, at the rate of four cents traveled by each car of the defendant company, amounting to \$15,040.50. The plaintiff alleges that no other company has any right to use its track without its consent for any purpose of traffic or carriage of passengers. The defendant company filed an exception, which was referred to the merits, and then answered, denying that plaintiff had a right to demand pay for the use of its road, as demanded, and that, if they had any right to demand compensation for the use of its road, four cents a mile for each car was too much, and claim that the ordinances of the City of New Orleans point out the manner in which compensation for the use of the road must be estimated and regulated. The defendant took several bills of exception to the introduction of testimony, some seven in number. They all go to the effect of the testimony, and it was properly admitted.

There is but one question to determine in the case: Was the defendant company authorized by legislative provisions to use the track of the plaintiff; and, in granting the permission, was the mode of compensation regulated? Complete authority has been granted by the general assembly to the city of New Orleans over the streets. The city of New Orleans has paramount control and regulation of them. The operation of a street railway is the exercise of the public right of way over the streets. The street belongs to the public. The proprietary right which a street railway has in its track is therefore subject to the right of eminent domain over its streets vested in the city. The city council may, in the exercise of the power delegated to the corporation in the control and regulation of the streets, grant to one company the right of way over them, and afterwards grant the right of way over a part of the same railway to another company. The city council is without power to grant the exclusive use of a street which belongs to the public to a railway company. It can not thus deprive succeeding councils of the power of performing the duty of regulating the streets as may seem to them to be for the best interest of the public. There can be no doubt but that the Crescent City Railroad company had the right to construct and operate its railway, and a part of the line covered a part of the plaintiff's track, on Canal street, and the intersection of St. Charles street, as described in the petition. And there can be no doubt but that the defendant company had been granted the use of the plaintiff's railway, and that with the consent of plaintiff it peaceably put its cars on plaintiff's track and has kept them running on a part of it since that time. Before the operation of defendant's street railway, the city council, in 1868, passed the following ordinance: "Should the city of New Orleans, at any time during the existence of the contract of 6th of May, 1867, between it and the Canal and Claiborne Street Railroad company, enter into any arrangements with other companies whereby said road on Canal street, from Claiborne street to Front Levee street, and from Front Levee street to Claiborne street, or any part thereof, may be granted the city of New Orleans, or the road or roads to which

the privilege may be granted, shall reimburse to the Canal and Claiborne Street Railroad company a fair and reasonable proportion of the value of the portion or portions of the road to be used; and, should said proportion not be agreed upon between said Canal and Claiborne Street Railroad company and the city of New Orleans, or the said road or roads, two disinterested persons shall be appointed,—one by the city of New Orleans or the road or roads, as the case may be, and the other by the Canal and Claiborne Street Railroad company; and, in the event of a disagreement, as to the said proportion to be paid, between said persons thus appointed, a third person or umpire shall be appointed by the judge of one of the district courts of the parish of Orleans, and the decision thereby had shall be final and finding." Ordinance No. 1204, N.S., p. 427; Jew. Dig. art. 151. In this ordinance the city council has not only granted the privilege to another company, which it may authorize to operate a street railway, to use the track already constructed, but it has pointed out and regulated the manner in which compensation must be made. The city had the undoubted power to grant the privilege of the right of way and regulate the manner in which one street railway using the track of another should make compensation. *Railway company v. Railway company*, 28 Amer. Law Reg. 765.

The plaintiff company has failed to follow the requirements of the ordinance.

Judgment affirmed.

WORN BUT UNMUTILATED COIN IS GOOD TENDER FOR FARE, AND EJECTION UPON SUCH TENDER IS ACTIONABLE.—*Morgan v. Jersey City and Bergen Railway Company*; Supreme Court of New Jersey, November 13, 1889.

SCUDDER, J. The defendant company was running a horse car railroad in certain streets of Jersey City. The plaintiff and his wife entered one of their cars, and, after riding a short distance, he handed to the conductor, in his own language, "one of the coins, ten cents,—a smooth American coin." The amount was right for two fares; but the conductor refused to receive the coin, because it was worn smooth. The plaintiff protested, paid his wife's fare, five cents, with another small coin, and on refusal to pay for himself with any other money than the dime he had offered, was ejected from the car. This action was brought to recover damages for the alleged unlawful ejection, and a recovery had by the verdict of a jury. On the writ of error in this court the single question presented is whether the judge, in his charge to the jury, gave the proper direction. He said that the plaintiff "tendered this ten-cent piece, a genuine and recognizable coin of the United States, and that was his lawful fare, provided that you believe that the coin is in the condition in which it was when issued from the mint, except as it had been changed by proper use. If there has been no other abrasion, no other wearing away, no other defacement of that coin, except such as it has received in the passing from hand to hand, then it is still, under the laws of the country, a good ten-cent piece, and was the fare of the plaintiff. If you think it has been otherwise changed, willfully changed, etc., it has ceased to be a lawful coin of the country, and it has ceased to be lawful tender." This instruction, we think, is substantially correct. By the act of March 3, 1875, (Rev. St. U. S. § 3586,) "the silver coins of the United States shall be a legal tender, at their nominal value, for any amount, not exceeding five dollars, in any one payment." By the act of January 9, 1879, (Supp. Rev. St. U. S. 488,) the holder of any of the silver coins of the United States of smaller denomination than one dollar may, on presentation of the same in sums of \$20, or any multiple thereof, at the office of the treasurer of the United States, receive therefor lawful money of the United States. Section 3 increases the legal tender of silver coin to the sum of \$10, instead of \$5, under the previous statute. In section 3585 of the Revised Statutes, the gold coins of the United States are made a legal tender in all payments at their nominal value, when not below the standard weight and limit of tolerance for the single piece; and, when

reduced in weight below such standard and tolerance, shall be a legal tender at valuation in proportion to their actual weight. The limit of tolerance for gold coin referred to is found, in sections 3505 and 3511, to be, when reduced in weight, by natural abrasion, not more than one-half of 1 per centum below the standard weight prescribed by law, after a circulation of 20 years, as shown by the date of coinage, and at a ratable proportion for any period less than 20 years. This particularity in the limitation and allowance as to gold coin is not found in the case of natural abrasion in silver coins. This difference is very noticeable and important in a question of statutory construction and legislative intention. It seems by these statutes that, so long as a genuine silver coin is worn only by natural abrasion, is not appreciably diminished in weight, and retains the appearance of a coin duly issued from the mint, it is a legal tender for its original value. *U. S. v. Lissner*, 12 Fed. Rep. 840. The coin in question in this case was shown in court to the jury. It does not appear in the evidence to have been so worn that it was light in weight, or not distinguishable as a genuine dime. With no limitation put upon its circulation by the government, it would seem that none was intended, so long as it was not defaced, cut, or mutilated, and was only made smooth by constant and long-continued handling, while being circulated as part of the national currency. The instruction was right, as the facts appear, and as the jury found them; and the judgment will therefore be affirmed.

## STREET RAILWAY NEWS.

(See also "New Enterprises," "Extensions," "Elections," etc.)

(The following data is compiled with all possible care, but the publishers, receiving news as they do, from almost every state, territory and country, cannot be held responsible for errors, as it would be wholly impossible to obtain a verification of each item received by them in time for each issue.)

## ARKANSAS.

*Little Rock.*—The rumor that the Little Rock Street Railway company is negotiating for the sale of its interests to some Chicago men has been revived, although nothing definite regarding the move has, as yet, been made public.

## COLORADO.

*Pueblo.*—The Pueblo Rapid Transit company has applied for right of way on certain streets through which it is proposed to operate an electric line.

## DELAWARE.

*Wilmington.*—At the regular quarterly meeting of the stockholders of the Wilmington City Railway company a dividend of 2½ per cent. was declared upon the receipts for the past six months.

## DISTRICT COLUMBIA.

*Washington.*—The Eckington and Soldiers Home Railway company has increased its capital stock \$100,000 for the purpose of extension. (See Extensions.)

## ILLINOIS.

*Springfield.*—The city council has passed ordinances authorizing the two street railway companies to change their motor power to electricity. We understand that R. N. Bayliss and J. Vanglinkel, two capitalists of Des Moines, Iowa, have bought one of the railways and will put in electric motors at once.

## INDIANA.

*Indianapolis.*—One of the most brutal occurrences that ever took place in this city occurred on the night of January 20th, when a negro jumped on the front platform of a south side car and fatally stabbed the driver, Morris Parry, and escaped with his money, or change box, before the passengers knew anything unusual had occurred. We have yet to learn whether the murderer was captured or not.

## MASSACHUSETTS.

*Gloucester.*—The Gloucester Street Railway company has petitioned the legislature for the privilege of operating its cars by electricity.

## MINNESOTA.

*Duluth.*—The Duluth Street Railway company will commence work on an inclined cable road.



in the immediate future. Animal power will probably be abandoned on the lines of the company and electricity adopted.

**Minneapolis.**—We are authorized by Supt. Goodrich to state that the Minneapolis City Railway company has cancelled all orders for cable railway supplies, amounting in all to over \$200,000, and electricity will be adopted in the immediate future. The news is confirmed by President Lowry, who was met by a representative of the GAZETTE at the Grand Pacific hotel in Chicago. Col. Lowry says that the same deal will apply to St. Paul. Col. Lowry states that he has become a thorough convert to electricity.

Permission given by the City Council of this city to the Minneapolis Street Railway company, to use electricity as a motive power on its lines was as follows:

Resolved by the city council of the city of Minneapolis: "That the Minneapolis Street Railway company be and is hereby permitted and authorized to substitute experimental electric street railway lines substantially similar to the one heretofore constructed and now being operated by it on Fourth avenue south, on the conditions hereinafter contained, on the following lines:

First. "On the two lines which by the resolutions of the council, passed July 19th, 1889, and approved July 26th, 1889, and by resolution of the council, passed June 29th, 1889, and approved July 1st, 1889, it was authorized and by its agreement made in pursuance to said resolution it agreed to construct and put in operation cable lines during the year 1890, to wit: The Washington avenue and First avenue lines:

Second. "On any of its existing horse car or motor lines where it may desire, and shall make such substitution during the year 1890; provided, said company shall within 30 days after the passage of this resolution accept the above permission and agree to the following condition:

A. "If at any time on or before April 1, 1891, the city council shall determine any or all of said electric lines to be unsuccessful or not equal to the cable lines ordered, then this resolution shall be of no further force or effect, and the council may order cable lines substituted for said electric lines on the Washington avenue and First avenue lines, according to the terms of the previous agreement, and may also order the discontinuance of electricity as a motive power on any of the other lines that it may see fit, where it is substituted under the terms of this resolution.

B. "Said company shall not run on said electric lines more than two cars attached together, one of which shall be the motor car, and the trolley lines maintained by said company shall have such guards to prevent accidents as the council shall from time to time direct.

C. "Said experimental electric lines substituted for cable lines shall be built and put in operation within the time prescribed by said resolution for building and putting in operation said cable lines respectively for which electric lines are substituted:

D. "The provisions of said resolutions of July 19, 1889, and all other ordinances and resolutions of the council shall not be modified or affected hereby, except in the particulars above indicated.

E. "In case any other electric system preferable to the overhead wire system shall prove a practical success in other cities, the council shall have the right to designate any existing line operated by the Street Railway company as the line on which to experiment of said new electric motive system and said company shall at once proceed to equip said line so designated with said new electric system, and, if after the same has been operated six months, the council deems it practical and superior power to the overhead system, the council shall have the right to order the entire existing street railway system, or any line or lines thereof, to be operated with such new electric motive system.

F. "The sureties on the bond executed for the faithful performance of the agreement made pursuant to the said resolutions of July 19, 1889, shall in writing within 30 days signify their consent to the modifications of said agreement as contained herein, or the Minneapolis Street Railway company shall substitute a like bond satisfactory to the city council.

G. "If the said city council shall not at any time on or before April 1, 1891, determine electricity to be an unsuccessful motive power, then the said Minneapolis Street Railway company shall equip with electricity and put in running order all its then existing horse car or motor lines by December 1, 1891.

H. "All passenger cars on electric lines shall run between extreme limits on all extensions to the heart of the city without change to passengers traveling thereon.

D. "Whenever any electric or cable line crosses any city bridge, the weight of the rolling stock, together with the loads they may be required to carry, shall not be in excess of the weight that shall be determined upon by the city engineer as a safe load for such bridge, and whenever or wherever city bridges are crossed by any line of street railway, the kind of rail to be used shall be of such pattern as to have a flange of not less than five inches in width, and shall be subject to the approval of the city engineer, and wherever it may be determined by said engineer that any part or portion of said bridge requires strengthening on account of the conditions of loading necessitated by the use of said bridges for street railway purposes, said street railway company shall be required to make the necessary changes at its own cost and expense. All changes made to be under the direction and to the satisfaction of the city engineer."

#### NEW HAMPSHIRE.

**Concord.**—The annual meeting of the Concord Horse Railroad was held January 15th. The report of the board of directors shows a favora-

ble state of affairs, the patronage steadily increasing. The directors say the road is in splendid order, suitable to run electric cars over it, especially the five miles above the office, to Penacook. There have been carried the past year 293,248 passengers, an increase of 33,280 over the previous year. An annual dividend of 6 per cent. has been paid.

The following is the report of treasurer Edward C. Hoague:

EARNINGS.	
Passengers .....	\$22,479 53
Rent, express advertising, etc. ....	209 36
Gross earnings .....	\$22 688 89
EXPENSES.	
Conductors and drivers .....	\$7,030 86
Maintenance of track .....	1,971 90
Coal, hay and grain .....	3,538 51
Salaries .....	925 00
Interest .....	357 08
Insurance .....	221 00
General expenses .....	3,215 82
	\$17,310 17

Net earnings .....

The balance sheet, December 31, 1889, is as follows:

ASSETS.	
Real estate .....	\$ 6,106 00
Equipment .....	15,451 69
Coal, hay and grain .....	577 25
Construction .....	32,165 49
Bills receivable .....	2,365 00
Cash .....	4,189 53
	\$60,848 96

LIABILITIES.	
Capital stock .....	\$50,000 00
Notes payable .....	2,400 00
Profit and loss .....	8,448 96
	\$60,848 96

The real estate account has been reduced \$3,776.59, and the equipment \$5,170.84, mainly on account of the fire. To offset these, however, there has been received \$2,923.64 insurance, and there is \$2,475 insurance adjusted but not paid.

**Laconia.**—At the recent annual meeting of the stockholders of the Laconia and Lake Village Horse Railway company, a dividend of 5 per cent. was declared. The report of treasurer was, that the earnings for the past year have been \$9,116.54. Of this sum \$3,011.46 has been paid out for wages. The net earnings have been \$2,560.68; passenger earnings, \$8,548.71; net gain in passenger earnings, \$1,166.68; assets of the company, \$33,518.99; capital stock, \$20,000. The number of round trips made were 10,575; number of miles run, 47,587; number of passengers carried, 168,047, increase in number of passengers carried over 1888, 3,623.

#### NEW JERSEY.

**Plainfield.**—We understand that the Daft company has rejected the franchise granted to operate its street railway under the storage battery system.

#### NEW YORK.

**Johnstown.**—The report of the Johnstown, Gloversville & Kingsboro Horse railroad (lesses) to the railroad commissioners for the quarter ending December 31st, is as follows: Gross earnings, \$3,582.23; surplus, \$1,025.97. Like quarter 1888: Gross earnings, \$3,323.17; surplus, \$756.92.

#### PENNSYLVANIA.

**Altoona.**—The annual meeting of the City Passenger Railway company of this city was held January 13th, and the annual report of the president and directors showed that the road was in a very prosperous condition, 135,229 more passengers being carried during the present year. There was a decided desire to operate the cars by electricity, and the company has an ordinance before the city council praying for permission. (A list of the new officers will be found under the head of Elections in present issue.)

**Chester.**—The annual meeting of the stockholders of the Chester Street Railway company was held on the 13th of January. The report of the general manager showed that the year had been one of marked prosperity, and under the judicious management of President Cornell, the property has been enhanced considerably in value, and nearly one million passengers were carried during the year. (A list of the directors will be found under the head of Elections.)

**Lancaster.**—We understand that the Lancaster and Millersville Railway company will probably adopt electricity in the near future or else

transfer its line to the electric railway syndicate; details of which were previously reported in the GAZETTE.

**Norristown.**—The Citizens Passenger Railway company, at a recent meeting of the stockholders, concluded to adopt electricity as motive power, and have its cars under operation by that system within the next six months. The receipts of the corporation during the past year proved satisfactory, as they were enabled to pay all running expenses and leave a slight surplus in the treasury. The passengers carried for the year ending January 13th, numbered 246,000, an increase over the previous year of 1,000. (A list of the officers and directors of this road will be found under head of Elections in present issue.)

**Norristown.**—At the annual meeting of the stockholders of the Norristown Passenger Railway company, President Lutz submitted his annual report as follows:

"For the first time in the history of your company, we are enabled to report a small net profit as the result of our operations for the year just closed.

Receipts from all sources, including passengers, rent and advertising spaces aggregated .....

Deduct expenses and taxes .....

Showing a net profit of .....

"During the year it was necessary to raise portions of your track on Powell street in Norris own and on Fourth street in Bridgeport. In addition to this a very considerable amount of money has been expended on the road bed extending over almost the entire system. A large part of this outlay was rendered necessary by the heavy rains and washouts of last summer. All the cost of this work has been charged to current expenses; and with the exception of two or three short pieces of road, the physical condition of the entire track can now be reported as good.

"Although sufficient has been earned to cover the payment of a dividend on the preferred stock, yet prudence would dictate that after applying a sufficient sum to cancel our "interest account," the balance be allowed to remain to the credit of profit and loss; especially as up to this date this latter has been a debtor account.

"The company's note in Peoples National Bank, which amounted to \$2,200 at time of our report one year ago, has found reduced to \$1,800. This now constitutes our entire indebtedness. If the 8 shares of preferred stock remaining in the treasury are subscribed for, the resulting amount of \$400 could be at once applied as a further payment on the note, reducing it to \$1,400. It, however, is now so small in amount as to give no cause for concern or anxiety.

"During the year we have lost one horse by death, and several now in our stables show unmistakable signs of the hard work incident to street car service. Efforts are now being made by our superintendent to get them into an improved condition. The introduction of some other kind of motor whenever the conditions admit of same will be hailed with satisfaction by all concerned.

"We have fortunately escaped any serious accidents or injury during the year to either person or property, beyond colliding with one or two private teams, the investigation into these cases proving them to have been caused by the contributive negligence of the drivers of the teams injured.

"The thanks of the company are especially due to the gentlemen of our Road Committee who have during the year given daily attention at the office of the company to the important service of opening and counting the contents of the fare boxes.

"It is only by such service and the faithful performance of duty by employes that your company can hope to reach an early dividend paying basis.

"H. M. LUTZ, President."

**Philadelphia.**—A new cable car of an advanced pattern, built by the Philadelphia Traction company, has been put on the Columbia avenue and Market street branch. The car has eight wheels on two trucks, is twenty-six feet in length, and will, it is said, seat comfortably forty-five people. The interior is handsomely fitted up with upholstered seats and finished in hard wood. The gripman occupies the left hand front corner of the car instead of the center.

The Philadelphia and Reading Street Railway company has received permission to construct an electric railway through the city to Arch street, but it is thought that the company will refuse to accept the grant as made, and that it will make a strenuous effort to obtain the right to build a road to Market street instead of only to Arch street.

The annual report of the People's Passenger Railway Co. shows that during 1889, 32,206,205 passengers were carried. The total operating receipts were \$1,157,033.89, and the total operating expenses, \$1,000,103.08, leaving the net earnings \$156,930.81, a gain in receipts over 1888 of \$72,734.58, and a decrease in expenses of \$6,118.23. During the year the tracks on Girard avenue were extended to Gunner's run,



and additional cars, horses and stable room provided, at a cost of \$52,663.70.

The annual report of President E. B. Edwards of the Ridge Avenue Railway, showed that during the past year the number of passengers carried was 7,175,546, an increase of 309,673, receipts, \$356,328.46, an increase of \$15,256.81 over the previous year; expenditures, \$206,508.90, of which \$88,252.53 was for running expenses, and \$54,403.33 for maintenance of stable.

At the recent annual meeting of the Frankford and Southwark Street Railway company it was shown that the total receipts of the company for the year were \$688,078.42; expenditures, \$429,859.17. The passengers carried numbered 14,537,127, an increase of 882,935 over 1888. The expenditures included \$36,871 taxes paid to city and state, and \$22,193 for repairs to streets.

The annual report of the Hestonville, Mantua and Fairmount company showed that the earnings were \$310,274.05; expenditures, \$262,869.03; balance, \$47,405.02; an increase of \$24,176.37 over last year; number of passengers carried, 6,390,310, an increase of 585,624 over last year.

Messrs. Wm. Wharton, jr., and others are endeavoring to get a lease of the Tenth and Eleventh street line.

**Pittsburg.**—The adjourned annual meeting of the Standard Underground Cable Co. was held last week. The report of the company shows a net profit during the year of nearly \$110,000, that being 11 per cent. of the par value of the capital stock, and leaves a surplus to the company of about \$150,000. No dividend was declared owing to the great amount of business the company had on hand, on account of which it was decided to nurse the surplus funds for the time being. We understand, however, that the company will declare its dividend by the first of April.

**Pottsville.**—The stockholders of the Schuylkill Electric Railway company held their annual meeting on January 13th. Valuable data in regard to the operations and success of electric roads elsewhere was submitted and the unanimous determination of the meeting was that the Pottsville road should be built at the earliest practicable period. There was much disappointment expressed that the action of Council had prevented the commencement of the work at the time originally contemplated, but the course of the management of the company when it had been fully explained, was unanimously approved.

The following report was submitted and approved by the meeting.

To the stockholders of the Schuylkill Electric Railway company, of Pottsville:

When the charter for the company was obtained on the fifth day of October last, it was the confident expectation of the management that work would be commenced upon the road in Pottsville by April 1st, 1890, and that cars would be running before the close of the summer. In order to accomplish this it was important that there should be no necessary delay. The reason of this was that because of the great number of electric roads now being built, it is requisite to give an order for material fully four months in advance.

A vital preliminary step was, however, to ascertain from Council what restrictions it would place upon the company's use of the streets. Upon the character of these restrictions would largely depend the question whether the road could be built and properly and profitably operated. It would therefore have been folly to have given orders for the costly material required by the road until Council's action was definitely known. This definite knowledge was, and is, also a sine qua non on the part of a number of capitalists who desire to be associated with the present stockholders in the carrying of the enterprise to completion. Recognizing these facts no time was lost in applying to Council. This application was made on October 15th.

After nearly two months' consideration of the matter, during which time every facility as to information was afforded by the management of the company and every concession made by it consistent with the practical and profitable working of the road, the whole subject was, on the 3d day of December, postponed by Council until next March. This unlooked for action of Council has postponed the commencement of the work until the late summer, provided it passes the ordinance promptly in March. Your management regret the state of affairs, but they feel that the delay is in no way chargeable to them. The citizens of Pottsville, who stand in great need of rapid transit and of the benefits which would accrue from it, are the chief sufferers by the delay, and the remedy for it is in their hands.

The management have investigated the working of the electric roads in other places, and are assured of the fact that they are everywhere regarded as great public benefits, and at the same time are profitable to the stockholders.

During the interval which must still elapse before Council's action shall be definitely known, the management will

perfect their plans so there shall be the least possible delay in putting them into execution. It is their firm belief that before their next annual report is made, a considerable portion of the road will then have been constructed and put in operation.

BURT S. PATTERSON, President.

**Wilkes Barre.**—The Suburban Electric Railway of this city has been a great success, and has carried nearly 300,000 passengers since its construction. At its recent annual meeting it was shown that there was a surplus of over \$5,000 over expenditures, and the company will probably buy two heavier motor cars this spring. (See Extensions.)

#### RHODE ISLAND.

**Newport.**—The annual meeting of the Newport Street Railway company, was held January 28; an effort will be made to increase the capital stock of the company from \$100,000 to \$200,000.

#### NEW YORK.

**New York City.**—The East River Central and the North River Railway company has requested permission to build a street railway from East River, through East Sixty-first street, Avenue A. Eighty-fourth street, Madison avenue, Eighty-fifth street and through the Eighty-sixth street transverse road in Central Park and West Eighty-sixth street to Ninth avenue, and thence through Ninth avenue and Seventy-ninth street to the North River.

The petition was referred to the railway committee.

**Rochester.**—The Rochester City and Brighton Street Railway company has received permission from the council to operate its cars by electricity. If this permission is granted the company will take up all its tram rail and relay its tracks with girder rails; it expects to have 40 electric cars in operation by the first of August, and to change its entire system of horse power to electricity within the next two years.

#### TEXAS.

**Houston.**—At the recent annual meeting of the Houston City Street Railway company, Mr. E. Buckingham offered the following resolutions which were adopted unanimously:

*Resolved*—"That the directors be and are hereby instructed to take immediate steps looking to the construction and extension of all necessary lines and extension of lines, on the streets covered by the franchises granted, or that may be granted hereafter, by the city council to the Houston City Street Railway company, and that work shall be commenced without delay and prosecuted to a speedy completion.

*Resolved*—"That a special committee of three directors be appointed to take into immediate consideration the matter of equipping the lines of the company with electricity, and such other matters in connection therewith, as may seem advisable and necessary for the most efficient services and best interests of the company."

The committee appointed is composed of Messrs. C. B. Holmes, William Dickinson and W. H. Sinclair.

#### WASHINGTON TERRITORY.

**Seattle.**—The incorporators of the West Street and North End Railroad company are making active arrangements for beginning work on the line, which is to be built to Ballard, and the work of constructing the road-bed will be begun at once and rapidly pushed to completion.

## NEW ENTERPRISES.

#### CALIFORNIA.

**Oakland.**—The Berkeley Rapid Transit company will build its road immediately. It is the intention to operate between Oakland City limits and Berkeley by means of electricity, and outside of the city horses will be used until such time as the state law will permit them to obtain an electric franchise within the corporation limits.

#### COLORADO.

**Pueblo.**—The Pueblo City Railroad company has filed its acceptance of the provisions of the ordinance granting it a rapid transit franchise. It has also filed a bond in the sum of \$15,000, conditioned upon the proper execution of the conditions named in the ordinance. The company has already ordered a large quantity of rails and machinery and declares its intention of proceeding with the building of the road as soon as it can obtain the necessary material.

#### DELAWARE.

**Wilmington.**—The Henion Electric Signal company, of this city, has been incorporated by

J. F. Johnson, Wm. Henion and R. F. Mullian. The capital stock of the company is \$20,000, and it is organized for the purpose of manufacturing electric railway signals.

#### DISTRICT OF COLUMBIA.

**Washington.**—The Washington and Mt. Vernon Railway company has been incorporated. Among the Washington incorporators are Gen. Eppa Hunton, James H. Hopkins, M. M. Parker, George Truesdell, E. K. Johnson, A. A. Thomas, L. Q. Washington, William H. Payne and William Clark.

#### ILLINOIS.

**Champaign.**—The Citizens' Electric Street Railway, of this city, has been incorporated with a capital stock of \$150,000. (A list of the directors will be found under head of "Elections" in the present issue.)

**East St. Louis.**—The Atwood Electric company has been incorporated with a capital stock of \$500,000, for the purpose of manufacturing lamps for locomotive headlights. The incorporators are C. C. Weaver, L. C. Atwood, E. B. Roth and others.

#### INDIANA.

**Indianapolis.**—The Jenney Electric Motor company has been incorporated with a capital stock of \$30,000. The new company succeeds to the business of Charles D. Jenney & Co., of the same city. The incorporators are Adison Bybee, Chas. D. Jenney, Julius F. Pratt and Edwin W. Jenney.

#### MAINE.

**Augusta.**—The contracts have been let for the building of an electric street railway between this point and Hallowell.

#### MASSACHUSETTS.

**Athol.**—But little doubt exists that an electric railway will be built from here to Orange, a distance of between five and six miles. A company has been formed for the construction and operating the road, having a capital stock of \$75,000. The following named gentlemen are reported to be interested: A. A. Selover, Sumner T. Durham and M. L. Bigelow of New York; A. Bangs and Converse Ward of Athol; R. D. Chase, Jay B. Reynolds and Edward Whitney of Orange; George F. Lord of Athol; R. S. Brown, M. Deakin, E. R. Devine and M. S. Clifford of New York; Edward L. Spencer and W. B. Dall of Brooklyn, N. Y.

**Boston.**—The West End Street Railway company has petitioned the Legislature for authority to locate, construct, maintain, equip and to operate by electricity or other motive power an elevated railroad or system of elevated railroads, in any or all of the several cities and towns in which it now is or may hereafter be authorized to run cars, with the right to connect the same with its present and future tracks, and operate the same in connection therewith.

#### MICHIGAN.

**Manistee.**—We understand that a thirty year franchise has been granted to Haines Bros., of Kinderhook, N. Y., for the construction of a street railway here. Unless this franchise is accepted within thirty days it will become void.

#### NEBRASKA.

**Beatrice.**—Articles of incorporation of the Wittenberg Street Railway company have been filed with the secretary of state. The capital stock is placed at \$30,000, of which ten per cent. shall be paid in at the commencement of business. A. W. Nickell, L. F. M. Easterday, L. M. Pemberton and W. Ebricht are the incorporators.

#### NEW JERSEY.

**Camden.**—Articles of incorporation have been filed by the Hercules Car Brake and Starter company. The objects of the corporation are to manufacture machinery, apparatus and appliances for starting, moving, stopping, reversing and regulating the speed of railway, tramway and traction cars. The capital stock is \$500,000. The amount paid in was given at \$400,000. The incorporators are Walter Smith, James Hogan, Archibald Dewey, Benjamin P. Wilson, all of Philadelphia, and Edward P. Wilson, of Atco, N. J.

**Jersey City.**—Jersey City is to have an elevated railway. It will run from the extension of the Central Railway of New Jersey to Com-



mupa, to Bergen Heights, thence through Johnson and Jewett avenues.

#### NEW YORK.

**Albany.**—The following certificates of incorporation were filed in the secretary of state's office here on January 31: The Harlem, Mott Haven & Morris Avenue Railroad company, with a capital stock of \$1,000,000, the road to be constructed from and to the following places in New York City: Commencing at or on 129th street and Third avenue, thence northerly along Third avenue to Harlem Bridge, across the bridge to Third avenue, to 134th street, to Lincoln avenue, to Third avenue, to Morris avenue, crossing Railroad avenue to Welch street, to Jerome avenue, through Claremont Park to Morris avenue, to Welch street, to Jerome avenue; also, with a branch commencing at Morris avenue and 161st street, west to Jerome avenue, to McComb's Dam Bridge, to 154th street, to Eighth avenue; also, with a branch commencing at Morris avenue and 161st street, running east along 161st street to Third avenue; also, with a branch commencing at the junction of 161st street and Mott avenue, running to 138th street, to Lincoln and Third avenues, thence along Lincoln avenue to 134th or 135th street to Third avenue, to and across Harlem Bridge, to Third avenue, and to and upon 129th street. Among the directors of the company are Franklin Edson, Hugh F. Camp, Richard Kelly and Henry W. T. Mali.

The Harlem, Brook Avenue & Woodstock Railroad company, of New York, with a capital stock of \$1,000,000; the road to be constructed over the following streets: Commencing at 129th street and Third avenue, to Harlem Bridge, to Third avenue, to 134th or 135th street, or both, to Brook avenue, to 149th street, to Tinton or Wales avenue, to Kelly street or 152d street, to Wales or Beach avenue, across Westchester avenue, to Tinton avenue, to 169th street, to Boston road, to Broadway, to the Southern Boulevard, through Crotona Park or around it, to Broadway, to Fordham and Pelham avenues. The incorporators are the same as those of the first road.

**New York City.**—The East River Railway company, organized for the purpose of building a road and tunnel under East river, from Broadway to Broome street, in this city, has been incorporated with a capital stock of \$100,000. (A list of the directors will be found under head of "Elections," in present issue.)

The North Third Avenue & Fleetwood Park Railroad company made application to the board of aldermen for permission to operate a surface railway over its proposed line, one mile and nine-tenths long. The board referred the application to the committee on railroads, who will give a public hearing in the common council chamber on March 13, at 1 p.m. The route proposed is on Third avenue, from 129th street, across Harlem Bridge to North Third avenue, to East Railroad avenue, to East 158th street, across the tracks of the New York & Harlem Railroad company, and West Railroad avenue, to Morris avenue, to the intersection of 165th street. The capital of the company is \$100,000, divided into 2,000 shares. The president is Matthew B. Wynkoop.

#### PENNSYLVANIA.

**Pittsburg.**—A charter has been granted to the Boyd Street Railway company, of this city. The capital stock is, we understand, \$3,000. The incorporators are: Joseph W. Wilson and Joseph Mitchell, of Pittsburg; W. W. Murray, of Knoxville; H. T. Rowley, of Wilkensburg, and S. S. Robertson, of Allegheny.

A charter has been filed by the Pittsburg & Lebanon Railway company to build a line from the point of Grand View avenue, on the Monongahela incline, to Mount Lebanon. It will be operated by either cable or electric power. The capital stock is \$100,000, divided into two thousand shares at \$50 each.

The Marr Construction company, the Keystone Construction company and the Washington Carbon company have consolidated under the name of the North American Construction company. The headquarters of the new amalgamation are in the Westinghouse building, in this city. About four hundred men will be employed, and the company has a capital stock of

\$500,000. (A list of the officers of the new company will be found under the head of "Elections," in present issue.)

#### TENNESSEE.

**Pittsburg.**—We understand that the South Pittsburg, Kimbill City & Jasper Street Railway has been incorporated for the purpose of building a dummy line from Copenhagen to Owens. Among the incorporators are: A. L. Spears, A. K. Alley, Foster V. Brown, W. E. Donaldson and W. D. Spears, of Jasper; J. C. Wall and H. I. Kimball, of Kimball City; Wm. Owens and P. H. Cook, of Owens; W. L. Kirkpatrick, of Copenhagen; F. P. Clute, J. C. Beene, Jephtha Bright, F. D. Arthur and W. D. Kelley, Jr., of this city, and Col. J. L. Gaines, Wm. Duncan, and others, of Nashville.

#### TEXAS.

**San Antonio.**—The Lakeview Rapid Transit company, of this city, has been incorporated, with a capital stock of \$100,000, to build a street car line three miles in length. The incorporators are: H. Elmendorf, William Parkiss and P. Watson.

#### WASHINGTON TERRITORY.

**Tacoma.**—Messrs. W. E. Anderson et al., have filed notification of their acceptance of the franchise granted by the city council to build a street railway from Pacific avenue to 21st street, to A street, to Puyallup avenue, to East C street, thence to South 3d street, to East H, and thence to city limits. We understand the name of the company will be The Tacoma & Puyallup Street Railway company, and that work along the line of the road will be commenced immediately.

## ELECTIONS.

**Altoona, Pa.**—At a recent meeting of the stockholders of the City Passenger Railway company of this city the following officers were elected:

President—John P. Levan.

Secretary and Treasurer—J. J. Buch.

Attorney—H. A. Reilly.

Directors, John P. Levan, William Murray, A. J. Anderson, Dr. C. B. Dudley, C. A. Wood, David Koch, Andrew Kipple, James Lowther and Mr. Max Liveright.

**Asheville, N. C.**—At the annual meeting of the Asheville Street Railway company held January 14th, the following named gentlemen were elected as officers and directors for the ensuing year:

President—W. T. Penniman.

Vice-President—S. W. Battle.

Secretary and Treasurer—B. M. Jones.

Attorney—Thos. A. Jones.

Directors—J. G. Martin, T. W. Patton, J. H. Barnard, S. W. Battle, W. T. Penniman, W. R. Penniman.

**Beaver Falls, Pa.**—The stockholders of the Beaver Valley Street Railway Co. held their annual meeting Jan. 13th, and elected the following officers for the coming year:

President—H. C. Patterson.

Secretary and Treasurer—J. F. Merriman.

Directors—John Reeves, Geo. W. Coates, M. L. Knight, H. C. Patterson, Henry Hice, Harry Reeves, James M. May.

The Citizens' Electric Street Railway held their annual meeting Jan. 13th, and elected the following named gentlemen as officers and directors for the coming year:

President—James M. May.

Secretary and Treasurer—John T. Reeves.

Directors—H. C. Patterson, Harry W. Reeves, Geo. W. Coates, James Merriman, John T. Reeves, Prof. M. L. Knight, James M. May.

**Bridgeport, Conn.**—At a recent meeting of the directors of the Bridgeport Horse Railroad company Mr. Frederick Hurd was elected president to fill the vacancy caused by the decease of Mr. Albery Eames.

**Brooklyn, N. Y.**—At the meeting of the stockholders of the Brooklyn City Railroad company held in Brooklyn on the 13th of January, the following named gentlemen were elected as directors for the year 1890:

Daniel F. Lewis, Alexander Studwell, William H. Husted, Crowell Haddon, William M. Thomas, George W. Bergen, John C. Barron, Edwin Pack-

ard, Frank Lyman, Edward D. White, E. W. Bliss, H. M. Thompson and H. W. Slocum.

Inspectors of election:

Edwin Beers, Ransom B. Hinman and Thomas D. Carman.

**Camden, N. J.**—At the annual meeting of the stockholders of the Camden Horse Railway company the following officers and board of directors were duly elected:

President—W. S. Scull.

Vice-President—Edward N. Cohn.

Treasurer—G. Genge Browning.

Secretary—Morris W. Hall.

Directors—Wm. S. Scull, F. Wayland Ayre, G. Genge Browning, Edward N. Cohn and Benjamin S. Reeve.

**Champaign, Ill.**—The directors of the recently incorporated Citizens Electric Street Railway Co. are as follows:

W. S. Reyburn, Daniel Norrissey and J. W. Davidson.

**Chester, Pa.**—The annual meeting of the stockholders of the Chester Street Railway company was held on the 13th of January, and the following named gentlemen were elected as officers and directors for the ensuing year:

President—E. Mitchell Cornell.

Vice-President—Hugh Shaw.

Directors—William S. Blakeley, S. A. Dyer, Thomas J. Houston, George B. Lindsay, Hugh Shaw, J. Lewis Crozer, E. M. Cornell, Richard Miller, Albert Roop.

**Cincinnati, O.**—At the recent annual meeting of the Mt. Adams and Inclined Railway Co. Mr. John Kilgore, president of the Cincinnati Street Railway Co. was elected president, vice George B. Kerper resigned, and the following named gentlemen to the board of directors:

John E. Bell, Charles Hofer, John Kilgore, J. E. Mooney, J. H. Rogers, Wm. Durrell jr., and Joseph C. Thoms.

**Cleveland, O.**—At the annual meeting of the Woodland Avenue & West Side Street Railway Co. held Jan. 13th, the following named gentlemen were elected as officers and directors for the ensuing year:

President—M. A. Hanna.

Vice-President—C. F. Emmery.

Superintendent—G. C. Mulhern.

Secretary—J. B. Hanna.

Directors—Messrs. M. A. Hanna, C. F. Emmery, Charles A. Otis, George H. Warmington, R. R. Rhodes, D. P. Eells, J. H. Wade jr., J. F. Card and H. P. Eells.

**Concord, N. H.**—The following named gentlemen have been elected as officers and directors of the Concord Horse RR Co. for the ensuing year:

President and Superintendent—Moses Humphrey.

Treasurer—E. C. Hoague.

Clerk—N. E. Martin.

Directors—Moses Humphrey, Howard A. Dodge, Dexter Richards, Paul R. Holden, George A. Cummings, George W. Abbott, John H. Albin.

**East Harrisburg, Pa.**—At a meeting of the stockholders of the East Harrisburg Passenger Railway company, which was held on the 13th of January, the following named gentlemen were elected as officers for the ensuing year:

President—John Q. Denney.

Directors—George Pancake, T. D. Greenawalt, John Hoffer, E. C. Felton, David Fleming, jr., James M. Cameron, Charles L. Bailey, jr., George H. Stewart, John Q. Denney.

**Gloversville, N. Y.**—The annual meeting of the Johnstown, Gloversville and Kingsboro Horse Railroad company, was held at Johnstown, Jan. 14th, and the following officers and board of directors were elected for the ensuing year:

President—W. S. Northrup.

Vice-President—Lewie Veghte.

Secretary—L. Caten.

Treasurer—John McLaren.

Directors—D. A. Wells, John McNab, W. J. Heacock, Chas. Judson, George C. Burr, Martin Kennedy, Jonathan Ricketts, James Younglove, Nathan Littauer.

**Grand Rapids, Mich.**—At the annual meeting of the North Park Railway company, held Jan. 13th, the following named gentlemen were elected as officers for the ensuing year:

President—Geo. W. Thayer.



Vice-President—George G. Briggs.

Secretary and Treasurer—C. C. Comstock.

Directors—Julius Houseman, James Blair, A. J. Bowne and John E. More.

**Houston, Tex.**—The stockholders of the Houston City Street Railway company met on Jan. 24th, and elected the following gentlemen as officers and directors:

President—William H. Sinclair.

Vice-President—C. B. Holmes.

General Manager and Secretary—H. F. MacGregor.

Superintendent—Fred Mundes.

Directors—C. B. Holmes and William Dickinson, Chicago; W. H. Sinclair, Galveston; E. P. Hill, W. D. Cleveland, T. W. House and H. F. MacGregor, Houston.

**Laconia, N. H.**—At the annual meeting of the Laconia & Lake Village Street Railway company, the following officers and directors were elected:

President and General Manager—A. G. Folsom.

Clerk and Treasurer—Mr. Edmund Little.

Directors—A. G. Folsom, Charles A. Busiel, S. C. Clark, S. B. Smith, E. C. Lewis, J. Gilbert and Gardner Cook.

**Lancaster, Pa.**—The stockholders of the East End Passenger Railway and those of the Lancaster City Street Railway met Jan 13th, and the following named gentlemen were elected as officers and directors of both roads:

President—John A. Coyle.

Vice-President—Dr. M. L. Herr.

Treasurer—John H. Baumgardner.

Secretary—J. E. Ackley.

Solicitor—Walter M. Franklin.

Directors—Dr. M. L. Herr, John H. Baumgardner, Jacob B. Long, Walter M. Franklin, J. E. Ackley, Sumner T. Dunham.

At a recent meeting of the stockholders of the Lancaster & Millersville Railway company, the following named gentlemen were elected as officers for the ensuing year:

President—John C. Hager.

Vice-President—Henry S. Shirk.

Secretary and Treasurer—Charles Denues.

Directors—John C. Hager, Henry S. Shirk, Samuel Bausman, Michael Reilly, Jacob M. Frantz, Francis Shroder, Jacob H. Landis, Dr. P. W. Heistand, Andrew M. Frantz.

**Lebanon, Pa.**—At a recent meeting of the directors of the Lebanon Electric Railway, the following named gentlemen were elected as officers and directors for the ensuing year.

President—C. Shenk.

Secretary—Richard J. Meily.

Treasurer—Jacob H. Grove.

Directors—C. Shenk, Richard J. Meily, C. H. Meily, J. H. Behney, A. Frank Seltzer.

**Newport, R. I.**—The Newport Street Railway company has elected the following board of directors:

A. C. Titus, A. S. Sherman, T. T. Pitman, Eugene Griffen, J. T. Burdick.

**New York City**—The following is a list of the directors of the East River Railway company, recently incorporated:

Benjamin S. Henning, T. A. Patterson, Robert Whitehall, H. C. Hilmers, Grinnell Burt, C. H. Odell, Otto Andreas, jr., Alexander Curtis, C. W. Smith, and J. C. O'Brien.

The annual meeting of the directors of the Forty-second Street, Manhattanville and St. Nicholas St Ry. Co. was held Jan. 16th, and the following named gentlemen elected as officers for the year 1890:

President—John S. Foster.

Vice-Pres. and Treasurer—Alfred Skitt.

Secretary—Charles F. Naething.

Directors—Arthur Leary, Alfred Skitt, Alfred Wagstaff, John B. Dutcher, Charles Phelps, D. D. Conover, James Mathews, Joseph Haight, Jacob Fleishhauer, Charles F. Naething, William R. Foster, R. V. Harnett, John S. Foster.

Inspectors of Election—Thomas E. Stewart, Edwin F. Madan, Edward P. Barker.

The annual meeting of the Dry Dock, East Broadway and Battery Railroad company was held Jan. 14th, and the following named gentlemen elected as directors for the ensuing year:

William White, Henry A. Morgan, John M. Scribner, Richard Kelly, Peter J. Thorne, Charles A. Hotchkiss, John E. Hoffmire, N. Lansing

Zabriskie, John Lowry, John Byrns, Joseph Jacobs, William Richardson, S. Sidney Smith.

Inspectors of Election—Asher Foise, Milton Knapp, James J. McKenna.

**Norristown, Pa.**—At the annual meeting of the stockholders of the Norristown Passenger Railway company, the following named gentlemen were elected as officers and directors of the company for the ensuing year:

President—H. M. Lutz.

Directors—Henry Freedley, W. R. Pechin, Norman Egbert, Joseph Blackfan, N. R. Haines, J. Cloude Smith, Jos. A. Coleman, Isaac W. Smith, J. Morton Brown, Hugh McInnis, Samuel High, Morgan R. Wills.

At the recent meeting of the stockholders of the Citizens Passenger Railway company of this city, the following named gentlemen were duly elected as officers and directors for the ensuing year:

President—George D. Bolton.

Directors—John Slingluff, William H. Bodey, T. J. Baker, Patrick Curren, John J. Derr, Joseph Fornance, D. Y. Mowday, W. Saylor, William F. Slingluff, Henry C. Wentz, J. L. West and E. B. Bickel.

**Philadelphia, Pa.**—At a recent meeting of the stockholders of the Spruce and Pine Street Railway company the following officers were elected:

President—Matthew Brooks.

Secretary and Treasurer—J. Crawford Dewees.

Directors—J. Hicks Conrad, James McManes, Richard Dale, Arthur H. Craige, Edward S. Buckley and Samuel W. Woodhouse.

The following named street railway companies held their annual meeting in Philadelphia on the 14th of January and elected the following named officers for the ensuing year:

Citizens' Passenger Railway company:

President—Charles E. Ellis.

Directors—Charles T. Colladay, Richard M. Hartley, John H. Sloan, Frank H. Ellis and Thomas S. Manning.

Citizens' Fairmount Park:

President—John H. Sloan.

Directors—Charles E. Ellis, R. M. Hartley, Charles T. Colladay and John Q. Adams.

Citizens', North and South, Philadelphia:

President—John H. Sloan.

Directors—Charles E. Ellis, R. M. Hartley, Charles T. Colladay and Thomas S. Manning.

Continental:

President—William L. Elkins.

Directors—P. A. B. Widener, Clay Kemble, George W. Elkins, Wm. J. Elliott, George D. Widener.

Empire Passenger Railway company:

President—James McManes.

Directors—W. H. Kemble, W. L. Elkins, P. A. B. Widener, W. McClary, George H. Colket.

Frankford and Southwark Philadelphia Passenger Railway Co.:

President—Jeremiah J. Sullivan.

Directors—Messrs. Alfred Smith, John Noblit, Thomas McClary, Edgar Fries, James H. Gray, M. W. Lipper, Charles S. Lincoln, John L. Lawson, David Fleming, Horace Geiger, Frank Weckerly and George S. Gandy.

People's Passenger Railway Co.:

President—Thomas C. Barr.

Secretary and Treasurer—D. C. Golden.

Directors—R. N. Carson, William H. Sheldermine, J. J. Macfarlane, E. J. Moore and Lewis Walker.

Ridge Avenue Railway company:

President—E. B. Edwards.

Directors—John Lambert, Henry Norris, William S. Grant, W. T. Carter, R. A. F. Penrose, M.D.

Second and Third Street Passenger Ry. Co.:

President—Alexander M. Fox.

Directors—William Anspach, Andrew J. Holman, William Eisenbrey, M. Hall Stanton, Edwin T. Eisenbrey, Alexander L. Crawford, James A. Freeman, Horace T. Potts, George Hoff, Wm. Dulles, James McManes and William G. Fox.

Thirteenth and Fifteenth Street Passenger Ry. Co.:

President—B. S. Kunkel.

Directors—R. Creswell, George W. Hall, William R. Warner, John C. Bingham and Travis Cochran.

Union Passenger Ry. Co.:

President—Wm. H. Kemble.

Vice-President—P. A. B. Widener.

Directors—P. A. B. Widener, William L. Elkins, James McManes, Henry Bumm, William S. Stokley and Matthew S. Quay.

Wilkesbarre and Western Railway:

President—Joseph M. Gazzam.

Directors—Joseph M. Gazzam, F. W. Kennedy, Morris Liveright, John B. Stetson, Charles D. Barney, W. C. DeArmond, John M. Sharp, Max Hamberger, Charles Raht.

**Philadelphia, Pa.**—The Board of Passenger Railway Presidents has elected E. B. Edwards president, and Henry Croskey secretary (the latter the thirty-second time).

**Piqua, O.**—At a recent meeting of the directors of the street railway company here, the following named gentlemen were duly elected as officers for the ensuing year:

President—A. M. Orr.

Vice-President—D. Spencer.

Treasurer—F. M. Flesh.

Secretary—Frank Davies.

**Pittsburg, Pa.**—The following is a list of the officers of the Pittsburg & Lebanon Railway company, recently incorporated:

President—J. W. Friend.

Directors—J. W. Patterson, J. M. Schafer, W. J. Radcliffe, R. L. McCulley and John G. MacConnell.

At the recent adjourned meeting of the Standard Underground Cable company, the following named gentlemen were elected as officers and directors of the company:

President—George Westinghouse, Jr.

Directors—George Westinghouse, Jr., Henry Snyder, J. W. Marsh, Mark W. Watson, Robert J. Pitcan, H. Jackson and John H. Dalzell.

At the recent meeting of the consolidated North American Construction company, the following named gentlemen were duly elected as its officers:

President—James S. Humbird.

Vice-President and General Manager—F. S. Marr.

General Superintendent—H. W. Doubleday.

General Agent—E. H. Wells.

**Pottsville, Pa.**—At a meeting of the stockholders of the Schuylkill Electric Railway company, held in Pottsville January 13th, the following named gentlemen were elected as officers and directors for the ensuing year:

President—B. S. Patterson.

Secretary and Treasurer—John F. Zerbey.

Directors—J. H. Zerbey, B. S. Patterson, J. K. Sigfried and S. A. Losch.

**Rochester, N. Y.**—Arthur Luetchford has been elected president of the electric railway of Rochester, to fill the vacancy caused by the decease of the late Asa T. Soule. The officers of the road are now as follows:

President—Arthur Luetchford.

Secretary—J. Breck Perkins.

Treasurer—Chauncey C. Woodworth.

Directors—Arthur Luetchford, M. A. Verner, J. Breck Perkins, Chauncey C. Woodworth, William C. Barry and John N. Beckley.

**St. Louis, Mo.**—The following named gentlemen have been elected officers and directors of the Schultz Belting company for the year 1890:

President—J. A. J. Schultz.

Vice-President—Wm. P. Mullen.

Secretary and Treasurer—B. C. Alvord.

Directors—H. G. Brooking, H. F. Mueller, Wm. P. Mullen, Thomas W. Carter and J. A. J. Schultz.

**Seattle, Wash. Ter.**—At a meeting of the stockholders of the Green Lake Electric Railway company, the following named gentlemen were elected as officers for the ensuing year:

President—W. D. Wood.

Vice-President—James Leddy.

Secretary—C. E. Chapin.

Treasurer—V. Hugo Smith.

Manager—Dr. E. C. Kilbourne.

Trustees—W. D. Wood, E. C. Kilbourne, James Leddy, L. H. Griffith, V. Hugo Smith.

At a meeting of the stockholders of the Seattle Electric Railway company, held in Seattle, on the 14th of January, the following named gentlemen were elected as trustees to serve during the ensuing year:

L. H. Griffith, Angus Mackintosh, D. T. Denny, E. C. Kilbourne, V. Hugo Smith, Andrew Abbott.



**Springfield, Mass.**—At the annual meeting of the Springfield City Railway company, which was held on the 8th of January, the following named gentlemen were duly elected as officers for the ensuing fiscal year:

President—John Olmsted.

Treasurer—A. E. Smith.

Clerk—Gideon Wells.

Auditor—L. E. Ladd.

Directors—John Olmsted, George M. Atwater, James Kirkham, Gideon Wells and A. E. Smith.

**Syracuse, N. Y.**—At a recent meeting of the stockholders of the Central City Railway company, the following named gentlemen were elected as

Directors—H. H. Dunn, J. D. Oxmer, A. T. Goodwin, S. H. Beardsley and C. H. Childs.

**Trenton, N. J.**—At the fourteenth annual meeting of the City Railway company, which was held at the office of the company, in this city, on January 15th, the following named gentlemen were duly elected as officers and directors of the company for the ensuing year:

President—Wm. H. Skirm.

Vice-President—John Exton.

Secretary—H. B. Howell.

Treasurer—C. Y. Bamford.

Directors—W. H. Sharp, John Exton, H. B. Howell, C. Y. Bamford, W. H. Brokaw, R. P. Wilson, Joseph Rice, John P. Schweizer, Frederick Walter, Joseph B. Yard, John Heil, Wm. Ossenbarg and George Fitzgeorge.

**Troy, N. Y.**—At a recent meeting of the directors of the Troy & Lansingburgh Horse Railroad company, the following named gentlemen were elected as officers for the ensuing year:

President—Charles Clemingshaw.

Vice-President—Joseph B. Carr.

Secretary and Treasurer—Joseph J. Hagen.

**Utica, N. Y.**—At the annual meeting of the Utica Belt Line Street Railroad company, held January 14th, officers and directors were elected for the year 1890.

President—Lathrop R. Bacon.

Vice-President—John W. Boyle.

Treasurer—Charles W. Mather.

Secretary—Edward Bushinger.

Executive Committee—Lathrop R. Bacon, John W. Boyle, Charles W. Mather, I. B. Newcombe and Arthur J. Moulton.

Inspectors of Election—John H. Grant, Edward Bushinger and Thomas P. Weston.

Directors—Lathrop R. Bacon, I. B. Newcombe, Arthur J. Moulton, William M. Harriman, New York; Joshua Mather, Utica; John W. Boyle, Whitestown, and Charles W. Mather, Utica.

**Wilkes Barre, Pa.**—At a recent meeting of the stockholders of the Coalville Passenger Railway company, the following named gentlemen were elected as officers and directors of the company for the coming year:

President—G. Mortimer Lewis.

Secretary and Treasurer—George Loveland.

Superintendent—A. S. Orr.

Directors—George W. Kirkendall, E. Troxell, John G. Wood, George K. Powell and G. Mortimer Lewis.

## EXTENSIONS.

**Decatur, Ill.**—The Citizens' Street Railway company, which is now operating nine cars and six miles of line under the Thomson-Houston system, will extend its line some two miles in the immediate future and add three motor cars.

**Lowell, Mass.**—The Lowell Horse Railway Co. will extend its tracks to Chelmsford.

**Moline, Ill.**—The Moline Central Street Railway company will extend its line in the immediate future.

**Norwich, Conn.**—We understand that the street railway here will extend its line in the spring.

**Philadelphia, Pa.**—The Thirteenth and Fifteenth Streets Passenger Railway Co. will extend its tracks to League Island.

**Washington, D. C.**—The Eckington and Soldiers Home Railway company has been authorized to extend its tracks over certain streets, provided that the wires used for the propulsion of cars in said streets be placed underground.

**Wilkes Barre, Pa.**—The Suburban Electric Railway of this city will probably extend its line considerably early in the spring.

## Met on the Road.

COL. THOMAS LOWRY, of Minneapolis, at the Fifth Avenue Hotel, New York.

MR. SAMUEL INSULL, of the Sprague Electric Railway and Motor company, and the Edison company of New York, on the steamer "Britannic," on the eve of his departure for Europe.

MR. DANIEL COOLIDGE, Vice President of the Johnson company, Johnstown, Pa., in St. Louis and Chicago.

MR. JOHN N. REYNOLDS, at the Grand Pacific Hotel, Chicago.

MR. F. L. MARTIN, of Colorado Springs, in Chicago.

DR. W. L. ALLEN, of Davenport, in Chicago.

MR. W. L. FERGUSON, general manager and treasurer of the City Street Railway company, of Decatur, Ill., at the Grand Pacific, in Chicago.

MR. J. A. RHOMBERG, of Dubuque, Iowa, in Chicago.

MR. A. L. LAUGHTON, of Colorado Springs, in Chicago.

MR. W. R. MOORE, President of the Moline Central Street Railway company, of Moline, Ill., in Chicago.

MR. J. L. BARCLEY, of the Sprague Electric Equipment company, of New York.

MR. C. A. BENTON, of the Sprague Electric Railway and Motor company, of New York, in Nashville.

MR. H. L. Mc L. HARDING, of Chicago, at the Hoffman House, New York.

MR. J. W. MARSH, of the Standard Underground Cable company, Pittsburgh, Pa., in Chicago.

MR. J. WARD LEONARD, General Manager of the United Edison company, of New York, in Chicago.

MR. GEORGE WESTINGHOUSE, JR., at the Brunswick, in Boston.

MR. THOMAS C. NASH, of the Roebling Sons' company, in Chicago.

J. D. BASCOM, of Broderick & Bascom Rope company, St. Louis, in New York.

JOHN A. BRILL, of J. G. Brill company, Philadelphia, in St. Louis.

B. F. GOODRICH, Superintendent Minneapolis Street Railway company, on south-bound train, travelling *en famille* "from lands of snow to lands of sun."

SIDNEY H. SHORT, of the Short Electric Railway company, Cleveland, in Chicago and St. Louis.

JOHN PUGH, of the Baltimore Car Wheel company, Baltimore, in Kansas City.

J. H. MASON, Secretary of the Simplex Electrical company, Boston, en route from Boston to St. Louis, Kansas City, etc.

D. W. PUGH, of the John Stephenson company, New York, at Southern Hotel, St. Louis.

FRANK A. ROGERS, of the Short Electric Railway company, Cleveland, O., in St. Louis, Mo.

C. C. WOODWORTH, of Rochester, New York, is in Europe with his family.

WILLIAM SUTTON, Superintendent of La Clede Car company, in St. Louis; Mr. Sutton looked none the worse for his 125 car order.

## Curious Accident to a Cable Car.

The *World* of New York, states that car U on the cable road was injured by a singular accident at One Hundred and Thirty-third street and Tenth avenue. At this point the grade is very steep. John J. Farley, contractor, is blasting away the rocks on the east side of the avenue. He has a lofty derrick, steadied by wire-guy ropes, one of which extends across the avenue. While car U was up on Washington Heights an unusually heavy blast was set off and the derrick was shifted a little. The result was that one of the guy ropes sagged below the level of the car roof. This circumstance escaped the attention of the gripman until too late to avert disaster. The strong wire caught the roof and ripped away a large portion of it. The windows in front were smashed and the seats wrenched loose. There were but two passengers, who were thrown from their places, but not violently enough to injure them.

## Business Mention.

Mr. W. B. Knight, of Kansas City, has secured a contract for the construction of an electric railway in Memphis, Tenn. The line will be thirteen miles in length, with double tracks through all the city streets. Ten cars will be used.

The Walker Manufacturing company, of Cleveland, Ohio, has closed a contract with the Citizens Cable railway company of St. Louis, to change its present single drive plant to double drive, taking out the old machinery in solid drums replacing it with the Walker improved machinery of differential drums.

It certainly looks as though the differential drums made by this company are bound to come up to the top, as cable engineers are fast learning the value of these drums, and the great saving in power, cables and machinery effected by the use of same when compared with the old style of solid drums.

Mr. W. E. Boughton, who has charge of the Cincinnati office of Johnson company, Johnstown, Pa., is a man well known to the street railway fraternity. He was formerly secretary and treasurer of the Belt Street line in Washington, D. C., and Johnson company, always on the look out for the best men, could hardly have made a wiser selection for the office than it has made in Mr. Boughton.

## Obituary.

H. B. WILSON.

Heman Bangs Wilson, superintendent of the Eighth and Ninth avenue horse car lines, recently died at his residence, No. 315 West Fiftieth street, New York, of heart failure, superinduced by kidney trouble, aged sixty-three years. He was born in Westchester county in 1825. In 1853 he married a Miss Mary White and opened a livery stable at Eighth avenue and Fifty-first street. Two years later he entered the employment of the railroad company as a horse expert, and twenty-five years ago he was made superintendent, which position he held till his death. The time-tables and schedules now used on railroads were invented by him. He was a large stockholder in the People's line of steamboats. Five boys and three girls survive him.

## The Standard Theatre.

"The Runaway Wife" was the opening attraction at the Standard Theatre. Appreciative and large sized audiences demonstrated to the new management the fact that attractions of this order will make the success of the theatre assured. Mr. McKee Rankin assumes the leading character in the play, that of Arthur Eastman, and held the attention of the audience throughout the entire play. Miss Mabel Burt as Lady Alice is a beautiful woman with strong power of acting. The company's support is good above the average. Mr. Rankin then revived his famous plays, "19" and "The Banquet," and in these plays achieved his usual success. During the week ending Feb. 8, Dan Mason, one of America's funniest dialect comedians, will play in "A Clean Sweep." The general manager of the Theatre, Mr. Coxie, is certainly leaving nothing undone to make his one of the most popular of the Chicago theatres.

FOR SALE.—Owing to the fact of the equipping of our line electrically we will have for sale, about February 1st, 125 head of horses and fifty head of mules, all middle age stock and thoroughly adapted for street car work. Can sell and deliver 50 head of the above at any time. Also have 14 box cars and eight open cars 12, 14 and 16 feet long, mostly all Stephenson and Pullman cars. Can deliver open cars at once. Will sell at low price and easy terms to responsible parties. Call on or address SIOUX CITY STREET RAILWAY COMPANY, Sioux City, Iowa.

FOR SALE.—Two 11K. Porter Standard Gauge Dummies; One Baldwin Engine and Car Combined, at a very low price. For particulars address THE RIVERSIDE AND SUBURBAN RAILWAY CO., WICHITA, KANSAS.



Electric Street Railways in North America.

IN OPERATION OR UNDER CONTRACT FEB. 1, 1890.

Table listing electric street railways in North America, including columns for Operating Co., Location, System, Cars, and Miles. Entries range from Akron Electric Ry. Co. to Scranton Peoples Ry. Co.

Table listing operating companies and their locations, including columns for Operating Co., Location, System, Cars, and Miles. Entries range from Seashore Elec. Ry. Co. to Youngstown St. Ry. Co.

Street Railway Securities.

NEW YORK AND BROOKLYN.

Table of street railway securities for New York and Brooklyn, listing company names, par values, capital, periods, rates, last dividends, and bid/asked prices.

ST. LOUIS.

Table of street railway securities for St. Louis, listing company names, par values, capital, periods, rates, last dividends, and bid/asked prices.

HOLYOKE.

Table of street railway securities for Holyoke, listing company names, par values, capital, periods, rates, last dividends, and bid/asked prices.

PROVIDENCE.

Table of street railway securities for Providence, listing company names, par values, capital, periods, rates, last dividends, and bid/asked prices.

Bond Offerings.

OFFERED BY ROLSTON & BASS, 20 BROAD ST., NEW YORK.

BANGOR STREET RAILWAY COMPANY, BANGOR, ME. (ELECTRIC) 1ST M.

Table of bond offerings, listing rate, price, pays, amount offered, maturity, interest, miles bonded, issue date, and net earnings.



# Sprague Electric Railway System.

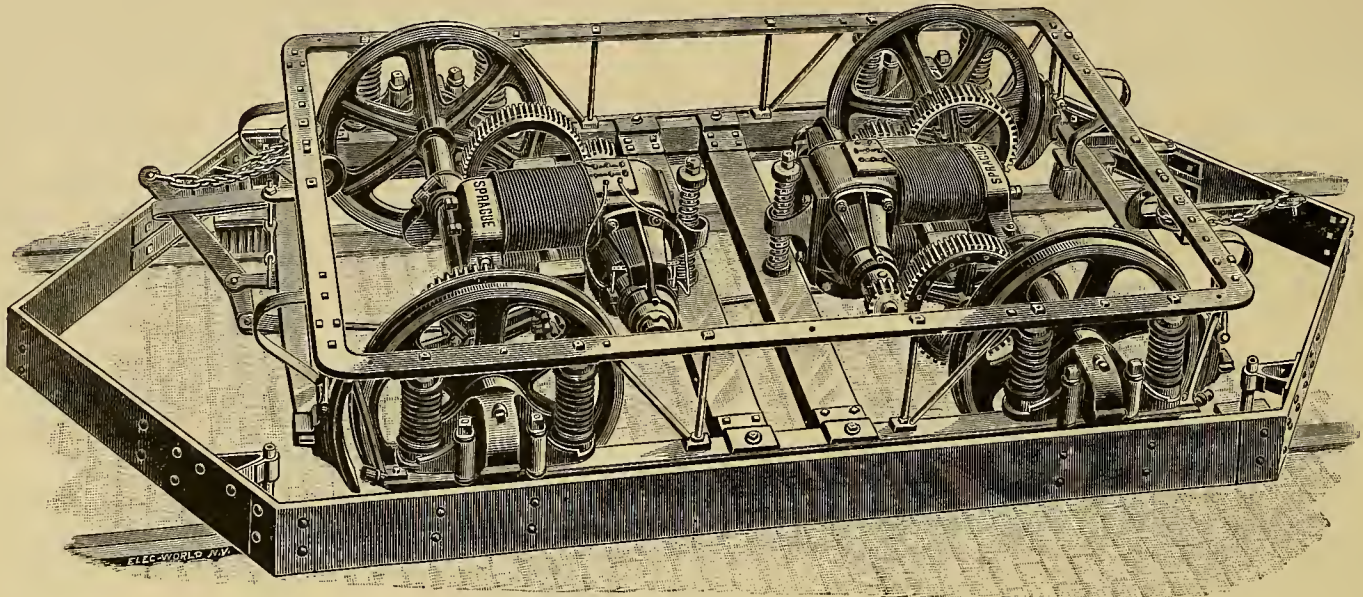

VIEW OF STANDARD TRUCK, EQUIPPED WITH SPRAGUE IMPROVED ELECTRIC STREET RAILWAY MOTORS.

The following features of correct mechanical construction essential to obtaining the best results with Electric Street Railways, are the exclusive property of the Sprague Company.

Centering the Motor on the Driven Axle.

Flexible or Yielding Support of Motor for Relief of Strains.

Universal Movement of Trolley Arm.

Single Lever Movement for Motor Control.

**GUARANTEE.**—In order to demonstrate the confidence which the Sprague Electric Railway and Motor Company feel in the economy of its system, it hereby makes the following Guarantee:

We hereby guarantee to operate a ten mile, thirty car, double track system with

Less Engine Power,

Less Loss in Motors; or in other words,

Less Dynamo Capacity,

More Car Miles per Ton of Coal,

Less Weight of Conductors,

More Miles of Line with a Given Loss,

Less Loss in Distribution,

More Territory Covered with a Given Outlay,

More Reserve Capacity in a Given Plant.

Which is to say, the Sprague Company guarantees a less cost per car mile run, inclusive of all charges incidental to Electric Railway operation than can be accomplished by any of its competitors.

The only award made at the Paris Exposition of 1889, for Electric Railway Apparatus, was a **GOLD MEDAL** given to the Sprague Electric Railway and Motor Company, for their exhibition of Electric Railways.

## Sprague Electric Railway and Motor Company,

16 AND 18 BROAD STREET, NEW YORK.



# The Street Railway Gazette.

(Copyrighted, 1890.)

VOL. V.

CHICAGO.

MARCH, 1890.

CHICAGO.

No. 3

## ELECTRIC RAILWAYS.

### Special Engine for Electric Railway Work.\*

We present herewith illustrations and description of the Ideal Special Electric Street Railway Engine, the standard pattern of which is already so well and favorably known. The design of the firm in perfecting this engine was to produce an engine which would meet successfully the special requirements found in driving the generators in electric street railway power plants where high rotative speed and perfect regulation should be combined in limited space and at the same time furnish a reliable and economical power.

This engine is notable for its double frame, making it doubly rigid with double cranks and shaft bearings, there being no outer board bearings and the engine being self contained. The main shaft, crank pin, connecting rod, piston rod and governor parts are all of high grade steel, and the cross-head is a crucible steel casting with removable hardened steel pin and cross-head slides, stuffing boxes and glands are phosphor bronze. All bearings are large and liberal, the main shaft bearings having a diameter of  $7\frac{3}{4}$  inches and a length of  $14\frac{3}{4}$  inches each. The guides are of liberal width and are cylindrical and bored at the same time with the cylinder and in exact line. The castings of the bed plate and other parts are made of best charcoal iron, heavy and well braced. The engine is shown mounted upon heavy cast iron sub-base or what is commonly called "foundation box," upon which it is tested in the works by running with brake and indicator. This base reduces considerably the cost of foundation, in addition to its neat appearance and substantiability.

One of the special features of the Ideal engine is the self-lubrication of every working part of the engine, which is rendered positive by its peculiarity of construction. It is claimed to be the only self-oiling engine that does not mix water with the oil. The oil channels are large and can not clog. The flow of oil over all bearings is positive; no oil is wasted or thrown upon floors, but is returned to the oil chamber to be used over again by being withdrawn and filtered. In the place of ten or twelve oil cups found upon most

engines, each of which must be carefully watched to keep the oil feeding drop by drop, this engine has but one oil receptacle from which the oil is automatically delivered in streams to all parts of the engine requiring lubrication. It is claimed that there has never been an instance of an Ideal engine stopping from hot bearings, and that it can be run for weeks or months without a stop.

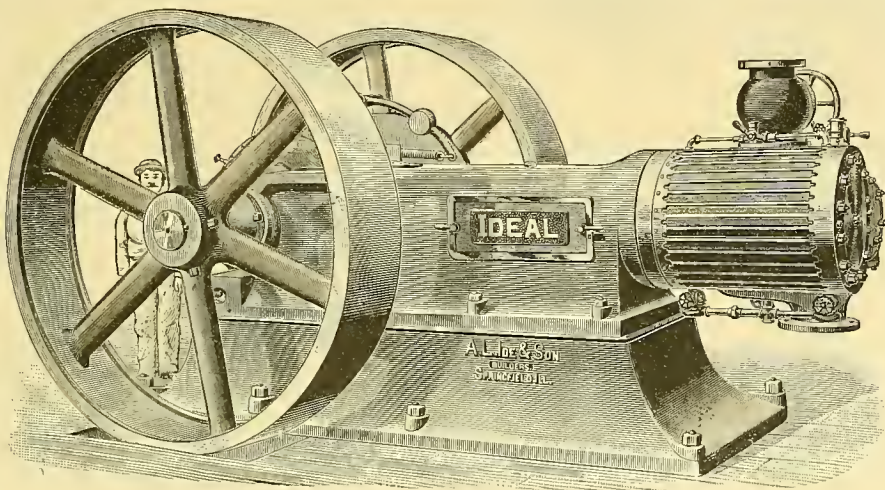

The working parts are as accessible as in any center crank engine without removing bolts or nuts, and it is the only self-oiling engine which permits of being opened while running.

The range of cut-off is wide and enables the engine to carry a load largely in excess of

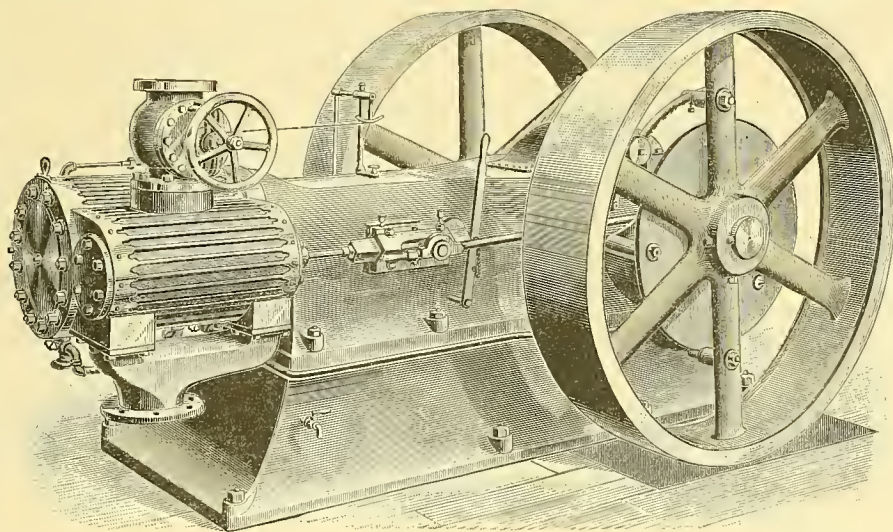

rating, as the point of cut-off is automatically extended to three-fourths stroke when an increased load requires it. The engine is built for constant heavy duty, and we have not heard of a case where they have failed to give entire satisfaction.

To the special features herein mentioned, the makers respectfully invite the attention and investigation of parties intending to equip their roads with electric power.

### Good Car Records.

When electric railways were first introduced, it used to be commonly said among street railway men that the motors were not built sufficiently durable and strong for the necessities of street car service. Such charges might have been true at that time, but they are certainly not applicable at the present day. The durability of the electric street railway motor, as exemplified by the productions of the leading supply companies of to-day, is probably as high, if not higher, than that of any other machine exposed to the same kind of service.

We are in receipt of some quite interesting statistics from Erie, Pa., in regard to the operation of electric cars upon the line of the Erie Electric Motor Co., in that city, which illustrates this in a striking manner.

One motor car on this line has run 19,300 miles without requiring any repairs of any kind.

A second car equipped with only a single motor, has run 15,000 miles without repairs being required, and other cars have records very nearly as large.

When the arduous work required of these street railway motors is taken into consideration, this is truly a remarkable record, and one which is most gratifying to all interested in electric traction.

The Erie Electric Railway has been in operation for a number of months, on the Sprague system, and is said to be giving great satisfaction to the managers of the road, and to the general public.

The equipment of the road is complete in every respect. At the station the power plant includes two 150 H. P. Ball engines with 16" x 16" cylinders, each engine being belted directly to two 50,000 Watt railway dynamos which furnish the current to the line.

The motor car equipment consists of fifteen electric cars, equipped with the Sprague improved motors with all the latest attachments and improvements.

When the installation of this electric line was proposed, there

was considerable opposition from property owners along the route who were not acquainted with electric railway systems, and objected to the installation of an unusual power. The road has become very popular however, on account of the rapid transit facilities afforded, and has carried large numbers of passengers since it has been in operation, without accident or delay.

\* A. L. Ide & Son, Springfield, Ill.



### Winter Business of the Sprague Company.

The mid-winter is not generally considered by Street Railway Construction companies to be the most active and busy time of the year. The condition of soil and weather are unfavorable to outside work, and the amount of business to be performed by the street railway companies is not so great as in the summer months, and does not encourage extensions. But with the prominent electric railway supply companies, the season seems to have no effect upon the amount of business contracted for, and under construction, unless it is to increase it. We are advised by the Sprague Electric Railway and Motor company, that this winter has made no difference with its business, and that during the last few

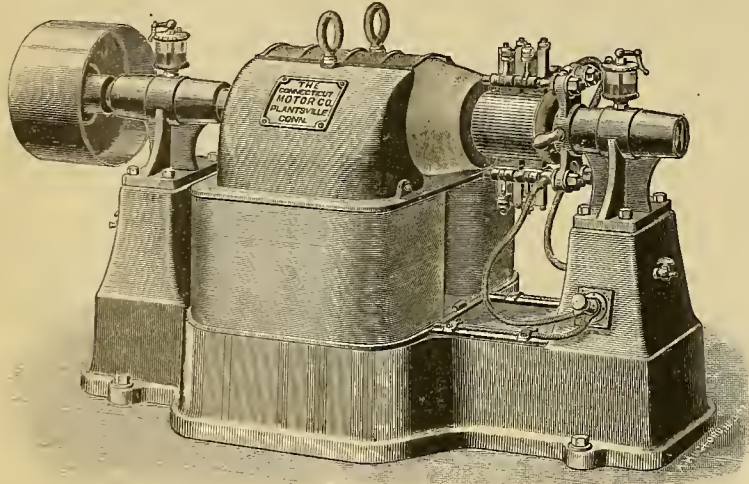

FIG. 2.

months an unusually large number of contracts have been closed for electrical apparatus, and that construction work has gone on through the winter.

A list of the roads which have ordered equipments from this company, illustrates in a striking way the remarkable confidence which street railway managers feel in the electric system, and is indicative of the general adoption of electrical traction. Among the recent contracts closed by the Sprague company may be mentioned the following:

Salem, Oregon, Capital City Street Railway, 2 cars.

Davenport, Iowa, Davenport Electric Street Railway company, 4 cars.

Dubuque, Iowa, Electric Light and Power company, 10 cars.

Chicago, Ill., Cicero and Proviso Street Railway, 12 cars; and the following additional orders from street railway companies now operating electric railways:

Sioux City, Iowa, Sioux City Electric Railway 3 cars.

Milwaukee, Wis., West Side Street Railway, 9 cars.

Des Moines, Iowa, Des Moines Electric Railway, 2 cars.

### Novel Application of an Electric Motor.

An interesting and novel application of electric power has recently been made in New York City, in one of the theatres where a spectacular play is being presented, in which one of the features consists of a horse race on the stage. In order to keep the horses constantly in view of the audience, the platform upon which the horses race is endless, and kept constantly moving over a pair of rollers at each end of the stage.

When the question of motive power for this movable stage was suggested, a Sprague Stationary Motor was selected for the work. This is belted to a system of counter-shafting which reduces the speed to that required by the rollers over which the movable platform revolves.

This is rather a novel application of electric power, but it is simply an example of the extensive and varied use to which electric motors are now being applied. When the manufacturers of this motor made the statement a year or so ago, that their motors were used in more than one

hundred and thirty different industries, the statement seemed almost incredible, but the convenience of the electric motor and its wide range of adaptability to all classes of work, have made it almost a necessity in places where no other motor could be used.

### Stationary Motor for Power Houses.\*

At first sight the close motion obtaining between railway and stationary motors, is not obvious, though a closer investigation shows them to be very nearly related indeed—both being often nourished from the same breast, so to speak. The principal cause, in fact the only cause, which militates against the universal use of the stationary motor, is absence of current supply. Of good motor manufacturers there are enough; of would be, and will be, users there are plenty; but of good, medium potential electric nourishment there is great scarcity. It is not that electricity is dear, but simply that the supply of power circuits is unequal to the demand. It is just this difficulty, which the combination of the two classes of motor can best overcome; for where the electric railway is there may be obtained good fresh current at market rates, and, conversely, where the demand for electric power is, there, the electric road can be operated to the best advantage.

We are glad to learn that the Connecticut Motor company of Plantsville, Conn., formerly of Hartford, which has for some time past been meeting the public demand for a high class stationary motor, has realized the importance of the foregoing remarks, and is now making a specialty of winding its machines for the class of work, and is meeting with its due reward.

It will be observed that the larger motors retain the single horseshoe type, experience having proved it to possess all the advantages and none of the disadvantages claimed for it. The field winding is plain shunt of high resistance. The armature wires are of large sectional area, making but few turns, thus reducing the air-gap to a minimum and securing close regulation of speed. These motors are, as compared with older designs, heavy for their power, their designer having appreciated the

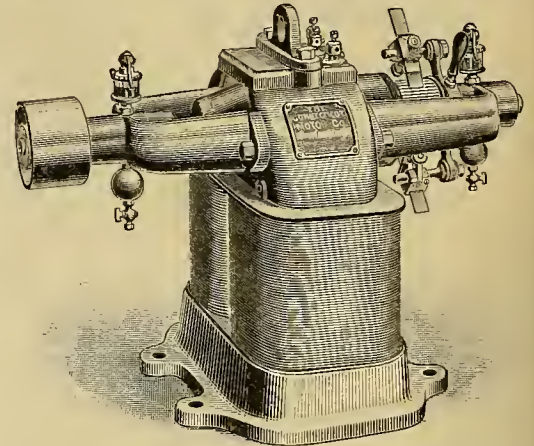

FIG. 1.

fact that they are to drive machinery in a business like manner without becoming hot and flustered like a boy trying to do a man's work. These motors were designed with but two objects in view, electrical efficiency and mechanical strength, though as a matter of fact they are by no means lacking in graceful proportions, and their workmanship is of the highest class.

### Electric Snow-Plow.

This plow is fitted with two 15 H. P. improved Sprague motors, and is so arranged that it can be run either forward or backward.

The reduction in gearing between the motors and the car axles is greater than in the ordinary Sprague car, so that a large amount of power is available from the motors in case of necessity.

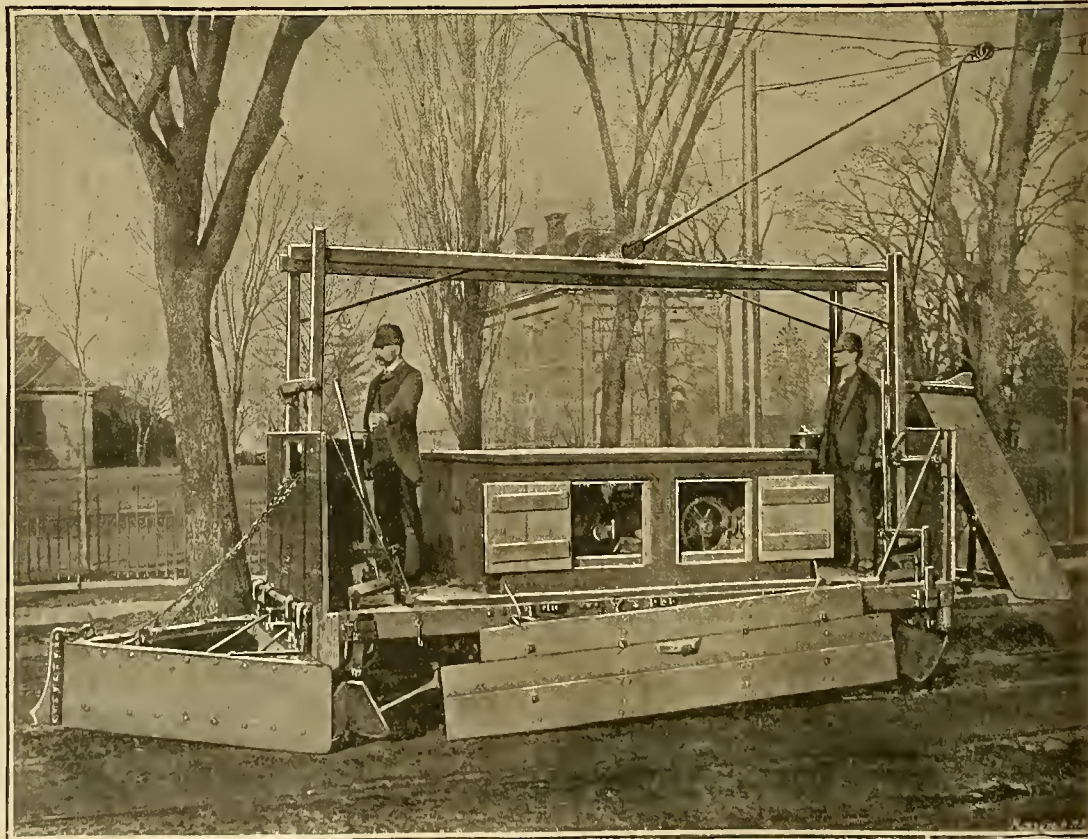

ELECTRIC SNOW PLOW.

Fig. 1 illustrates a new style of motor for small powers from one-half to five horse power, and is the design which first brought this motor into prominence. Fig. 2 has been now recently designed for higher powers, and is now fitted, though not shown in the cut, with self-lubricating bearing boxes.

\* Connecticut Motor company, Plantsville, Conn.

It is estimated that this plow will clear the track more speedily and effectually than an ordinary snow plow drawn by twelve horses.

We understand that the Sprague Electric Railway and Motor company have nearly completed a special electric sweeper and track cleaner for clearing the track of dust, dirt, slight snow-falls and other impediments.



**Tramway Sprinkler.**

The accompanying illustration represents a street sprinkling system now being introduced at Louisville, Ky. The company\* has leased for 15 years the privilege of using the tracks of the different street railways in that city, about 100 miles in all, and in addition have bought out all of the local sprinkling wagons, which gives the Tramway company a monopoly of the business on all streets. They now have under contract subscriptions for sprinkling amounting to over \$5,000 per month, and expect to realize a handsome profit out of the business.

The system was given a thorough test for several months last summer on 3½ miles of street at Louisville, which proved its efficiency and induced the railway men to encourage its extended introduction for the following reasons, viz.:

*First.* Because sprinkled streets will make travel more pleasant and thereby largely increase it.

*Second.* Tracks kept wet lessen the power to move cars fully twenty per cent., especially when the cars are rounding curves.

*Third.* It affords a new source of revenue from the lease of privilege and motive power to the sprinkler company.

*Fourth.* Streets well sprinkled build up faster than others. This adds permanent business and largely increases the receipts.

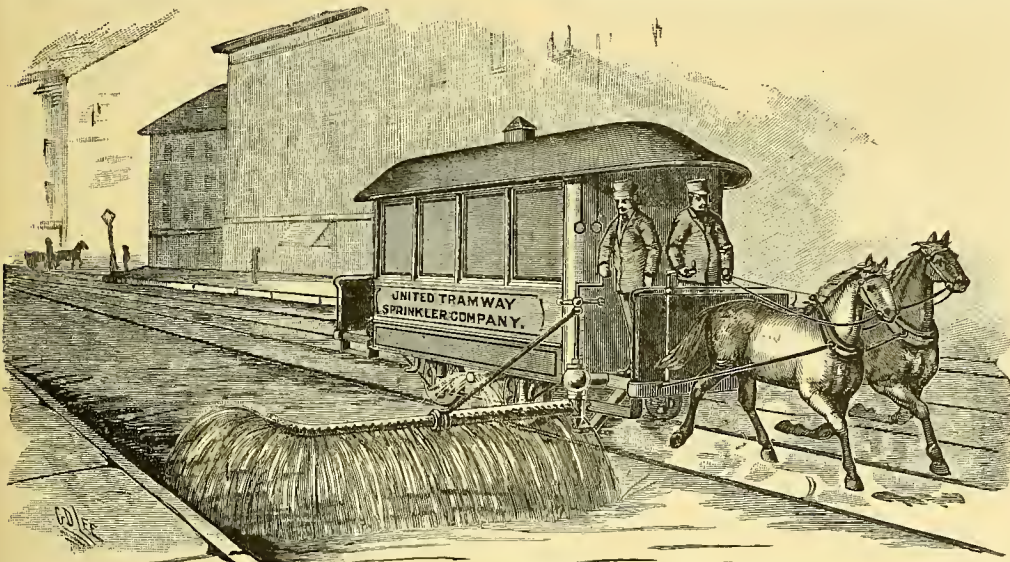

It has been demonstrated that one car propelled by two small mules will take care of over six miles of street, and do the work of five ordinary sprinkling wagons. Each car carries 1,800 gallons of water and distributes it with ease and efficiency through a crowded thoroughfare, avoiding vehicles without difficulty, and this on a 2½ minute line. The car stops about every half mile to fill with water, which is done under two minutes from flush hydrants with openings between the tracks, covered by ordinary iron cistern caps. There is no question about the success of the system. It has the endorsement of the street railway men of Louisville who were at first skeptical, but now fully approve it, and think it an advance in the age of progress.

**Motor for Electric Railway Power House.**

The accompanying illustration represents a fifteen h. p. motor for incandescent circuits, and is the standard type of machine made by the company† in all sizes above one h. p. The motors of one h. p. and under differ slightly, though not essentially, from the one here shown. The merit of these motors lies in their high efficiency, interchangeability of parts, self-lining bearings and also in strength and durability.

The lower pole pieces of the machine are cast in one piece with the bed, the upper one being a separate block. To these are bolted the field magnet cores. The cores are forged wrought iron shaped like segments of circle. This form of magnet construction gives the shortest possible magnetic circuits, thereby reducing the quality of iron used and the power required to excite the magnets. For this reason it is a very compact machine, requiring the least space for the

same power of any made. An improved Siemens winding is used and the armature and commutator are divided into more than the usual number of sections, thereby diminishing the danger of short circuits in the commutator. The bearings are self-aligning, so that they can not bind, allowing the armature to be taken out and replaced without trouble. The wearing parts are of hard cast bronze. An improved adjustable feed oil cup is used. The brush holders are supported on brass rods attached to a rocker arm which may be tightened or loosened at will. The pressure of the brushes may be adjusted by the

tion as well. It is believed that the combination of the two purposes will become more and more general and the efficiency and the excellent results obtained from the use of these high

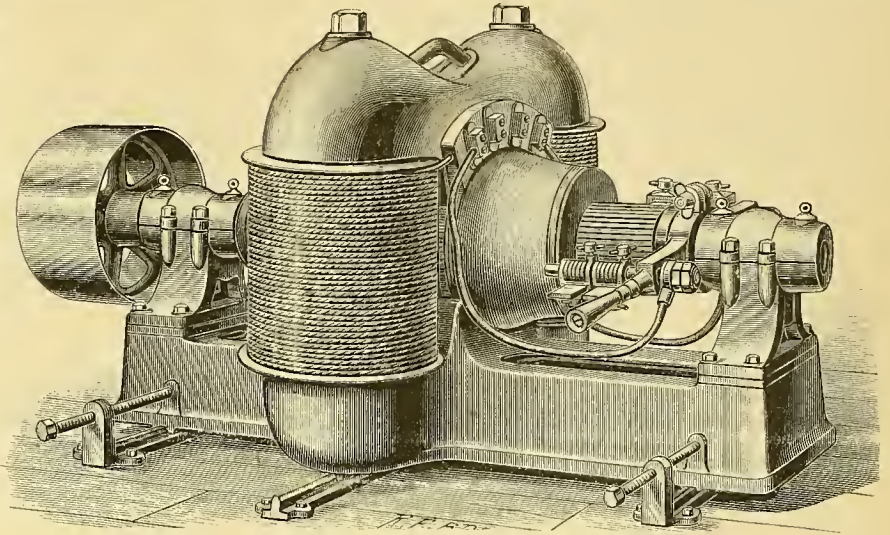

ELECTRIC STATIONARY MOTOR FOR RAILWAY CIRCUITS.

voltage motors, should certainly assist to this end.

**Electric Stationary Motor for Railway Circuits.\***

We notice that in the reports of a number of electric street railway companies which have been sent to us, the receipts for the sale of electric power for general industries by means of stationary electric motors along the line of the route, form no inconsiderable item. These motors are connected directly to the main wires of the electric railway by means of branch conductors, and can be belted to any machinery which it is desired to operate.

After the overhead wires for an electric railway have been installed, the generators and steam engines set in position, and the power station built, the additional investment and annual cost required to furnish electric current to owners of stationary motors are trifling, while the income from the sale of current is immediate and sure.

The subject of renting part of the electric current obtained from the dynamos of an electric railway power station for operating stationary motors is therefore attracting a great deal of attention among street railway managers, and a great many electric railway companies have ob-

slightest movement of a single nut. The machine stands on a stout wood base, provided with three slotted tracks on which the motor can be moved laterally by means of a hand wheel. The machine shown in the cut makes one thousand and fifty revolutions per minute, and regulates with three per cent for all load variations.

As these machines in all sizes above one h. p. can be wound for any desired voltage, it has been found in many cases convenient to put them to use on street railroad circuits where there is frequently a surplus of power which can thus be profitably utilized to operate some portion of a factory, or for any like purpose. In Appleton, Wis.; Seattle, Wash. Terr.; Elkhart, Ind.; Cambridgeport and Brookline, Mass., may be found these motors wound for from 400 to 500 volts, operated by means of current supplied from the overhead wires used by the electric railways. In stations built primarily for electric propulsion purposes, it is customary to place dynamos of a power far in excess of that actually required for the daily work. Although there is little loss due to the dynamos not being driven at their full power, yet the advantage would readily be appreciated of being able, in connection with the primary purpose of the plant, to reap the profits of a miscellaneous power sta-

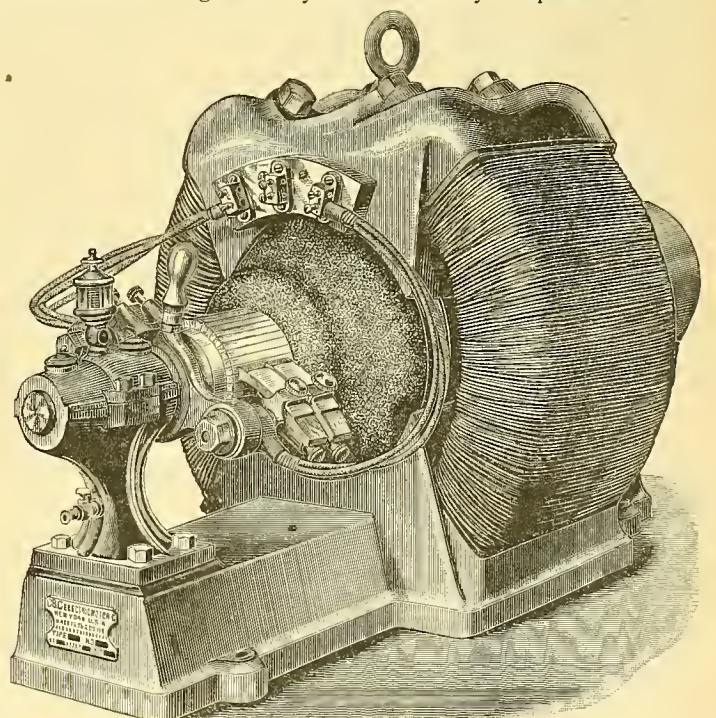

MOTOR FOR ELECTRIC RAILWAY POWER HOUSE.

tained with their franchise for operating street cars electrically, the right to supply power, though not all have adopted motors on to their

\*U. T. Sprinkler Co., Louisville, Ky.  
†C. & C. Electric Motor Co., New York.

\*The Sprague Electric Railway and Motor Co., New York.



circuits. It is a fact worth remembering that the call for current upon the dynamo at the power station to supply current to the stationary motors will occur at the time when the load for operating the cars is the lightest, and in this way the work required of the dynamo and steam engines will be evenly distributed. In other words, at the time when the cars are most loaded with passengers going and returning from their work the stationary motors along the line for supplying power will either not be started, or else will not be running to their full capacity, while during the business hours, while the stationary motors are in operation, the loads on the cars will be the lightest. In this way, the capital invested and the labor employed at the power station will be kept constantly in use, and will yield a double profit through the rent of power for stationary motors and through the earnings of the cars.

We illustrate in this issue, a new 50-horse-power stationary motor, which will undoubtedly meet with extensive use for general industries in connection with street railway circuits. The efficiency of this machine is quite high, being considerably over 90%, and great attention has been paid to the mechanical and electrical construction in order to make the machine as durable and reliable as possible.

These motors are automatic in their operation, regulating for a constant speed with varying loads, a condition which has proved a necessity in operating most kinds of machinery.

The governing device is entirely in the winding of the motor, and consequently inert; therefore there are no mechanical governing parts to get out of order.

Self oiling bearings are used, by means of which a thorough and complete lubrication of the armature shaft in the bearings is maintained.

In fact the design and construction of this motor has been throughout to make it as reliable and durable as possible, and to reduce all necessary attendance and care to a minimum.

Among other advantages of these stationary motors are their economy, minimum wear, fixed position of the non-sparking point under the brushes, and completeness of all mechanical and electrical details.

A large number of these motors of various sizes are in use on railway circuits in different cities.

**Large Mileage.**

A mileage of 100 miles per day is generally considered by street railway men as a fairly good record for a single car, but this opinion is not shared by the managers of the East Cleveland Street Railway company of Cleveland, Ohio.

This railway company has now in constant operation forty Sprague electric motor cars which make an average total mileage per day of 5,000 miles, or an average of 125 miles per day per car.

It is said that the managers of this road will soon have forty-six of these cars in operation, and will increase the daily mileage of their cars to 6,200.

Cleveland is now equipped with, probably, as good rapid transit facilities as any city in the country.

The East Cleveland Street railway, of which Dr. A. Everett is president, has seventy-five electric cars in operation or ordered for its various branches, the Brooklyn street railway has thirty-six, and the Broadway and Newburgh, twenty-four. This latter road has added eight Sprague cars to its original equipment.

John Stephenson Company, of New York, sends us a handsome little book entitled, "Motive Power for Street Cars."

It is printed on heavy book paper, with the engravings (ten in number) on plate paper. The book contains 71 pages of reading matter, which embraces the paper read by Mr. T. C. Barr at the Minneapolis convention of the A. S. R. A., entitled, "The Conditions Necessary to the Financial Success of Electricity as a Motive Power"—the discussion which followed it; the paper read by Mr. Windsor relative to "Street Railway Motors Other than Animal, Cable and Electric;" also the paper read by Mr. Bracken at the Buffalo convention of the N. E. L. A. (all of which were reported in full in the STREET RAILWAY GAZETTE) and other interesting matter.

**NATIONAL  
Electric Light Association.**

**Kansas City Convention.**

The sixth annual convention of the National Electric Light Association was called to order by President E. R. Weeks, in Coates' Opera House, Kansas City, Mo., at 12:30 noon, on Tuesday, February 11th.

Among the gentlemen attending the convention were:

- Allentown, Pa.—Harry E. Heller, T. P. A. C. B. & Q. RR.
- Atchison, Kas.—J. A. Chisham, — Wells.
- Baltimore, Md.—D. E. Evans, H. C. Tudor.
- Boonville, Mo.—J. F. Gwelich.
- Boston, Mass.—A. K. Page, Captain Wm. Brophy, H. J. Conant, D. J. Flanders, A. F. Mason, C. M. Kansom, Dr. Robert Amory, F. E. Barker, S. E. Barton, D. Killicut, F. A. Wyman.
- Bridgeport, Conn.—H. D. Stanley.
- Brooklyn, N. Y.—C. F. Coles, J. F. Munsie, E. J. Cook, E. F. Peck.
- Buffalo, N. Y.—C. R. Huntley, F. G. Raichle.
- Camden, N. J.—E. A. Armstrong.
- Cape May, N. J.—F. T. Walton.
- Carroll, Ia.—V. Hinrichs, E. M. Parsons.
- Carrollton, Mo.—James W. Lacy.
- Chicago, Ill.—C. G. Armstrong, G. C. Bailey, W. J. Buckley, E. V. Cavell, Editor STREET RAILWAY GAZETTE; F. W. Cushing, Geo. Cutter, A. C. Durbin Jr., "Western Electrician;" A. L. Davison, D. B. Dean, "Electrical Review;" D. T. Everts, D. S. Geer, C. E. Gregory, Ernest Hoefler, W. A. Kreidler, "Western Electrician;" Alex. Kempt, H. P. Lucas, W. W. Low, E. L. Powers, "Electrical Industries;" G. M. Smith, J. H. Shay, A. E. Smith, J. Stedman, F. S. Terry, "Electrical Supply Co.;" John Young, E. L. Clark, Geo. Atkinson, A. H. Bauer, S. S. Badger, C. H. Cone, A. L. Cloud, F. E. Degenhardt, J. W. Dickinson, Fred DeLand, "Electrical World;" C. W. Emery, E. D. Floyd, H. A. Glasier (H. L. Grant & Co.); Geo. T. Hewes, C. C. Haskins, G. A. E. Kohler, S. S. Leonard, H. T. Lockwood, W. B. Pearson, John Ritchie (Official Stenographer); Bernard H. Schmidt (J. G. Brill Co., Philadelphia); J. Stedman, R. J. Randolph, (Excelsior Company) C. H. Wilmerding, H. E. Longwell, G. S. Searing.
- Cincinnati, O.—E. V. Cherry, Emile Kahn, W. H. Jones, J. C. Hobart.
- Cleveland, O.—J. B. Crouse, W. C. Hayes, B. F. Miles, W. H. Lawrence, Frank A. Rogers, C. C. Curtis.
- Dallas, Tex.—D. M. Clower, Wm. Clower, W. M. Mottam.
- Denver, Colo.—C. H. Smith, E. W. Rollins, C. H. Brown.
- Detroit, Mich.—J. A. Campbell, A. A. Robinson, J. E. Lockwood, Fred H. Whipple.
- Ean Claire, Wis.—Carl Kammeyer, W. K. Freeman.
- Excelsior Springs, Mo.—E. B. Kay.
- Fort Scott, Kas.—H. S. Mitchell, N. C. Thompson, A. W. Walburn.
- Fort Smith, Ark.—R. H. Browne.
- Fort Wayne, Ind.—Chas. Knight.
- Fort Worth, Tex.—E. J. Jennings.
- Fremont, O.—C. T. Richmond.
- Greeley, Colo.—B. D. Sanborn.
- Hartford, Conn.—C. E. Newton, E. B. Hatch.
- Hayes City, Kas.—I. M. Yost.
- Houghton, Mich.—J. R. Dee, J. T. Daniels.
- Hutchinson, Kas.—L. A. Beebe.
- Indianapolis, Ind.—Chas. D. Jenney, L. A. Boyd, Geo. C. Pyle, F. W. Bangher.
- Jacksonville, Ill.—Frank M. Doan.
- Kansas City, Mo.—W. G. McGonnon, R. Macmillan, J. W. Mason, A. M. Morse, W. T. Osborn, M. S. Porter, H. M. Porter, C. H. Rusling, T. H. Reynolds, Paul Bossart, L. C. Bair, M. E. Bates, J. S. Chick, T. F. Clohesey, J. D. Cruise, H. M. Cutler, O. W. Ditsch, G. H. Elmore, T. F. English, C. C. English, W. B. Grimes, W. H. Woodring, G. M. Meyers, Floyd Platt, Ben Friedberg, C. H. Talmage, G. W. Johnson, C. A. Ross, O. H. Schramm, Jas. Scammon, W. F. Sargent, D. K. Smith, W. Wiley Smith, D. A. Williams, E. R. Weeks, Thos. Wolf, W. B. Grimes Jr., G. W. Hart, F. Howard, C. A. Harber, F. K. Hoover, F. K. Holtzinger, Ira C. Hubbel, L. S. Jenkins, W. B. Knight, Edw. Lasell, C. W. McDaniels, F. A. Kettler, W. D. House, Horace A. Keefer, W. M. Venawine.
- Kearney, Neb.—J. G. White (Western Eng. Co.)
- Lincoln, Neb.—M. J. Bigelow.
- Louisiana, Mo.—W. T. Johnson.
- McPherson, Kas.—J. B. Darrah, B. A. Allison.
- Meriden, Conn.—F. E. Knight.
- Milwaukee, Wis.—Henry Andrae, B. W. Smith.
- Montreal, Ont.—W. R. Kimball.
- Newark, N. J.—C. O. Baker, Jr., M. Garver.
- New Britain, Conn.—T. H. Brady.
- New Orleans, La.—E. H. McFall.
- Newton, Kas.—W. G. Oldfield, L. McCormick.
- New York, N. Y.—J. F. Kelly, W. S. Kelly, W. J. Johnston, "Electrical World"; Geo. Manson, A. H. Patterson, J. B. Taltavall, R. J. Gray, David Chalmers, W. S. Turner, C. J. Field, Wm. Hammond, J. W. Godfrey, J. B. Halsted, J. P. McQuaide, H. M. Haines, F. A. Magee, P. P. Wisner, G. M. Phelps, C. E. Stump, "Electrical World;" F. J. Sprague, J. A. Seely, S. S. Wheeler, H. Ward Leonard, C. W. Price, C. A. Schieren, Jr., G. P. Toby, B. R. Weston, E. H. Johnson, A. T. Mayer, R. W. Pope, H. L.

- Lufkin, P. H. Alexander, C. A. Benton, W. L. Candee, E. T. Greenfield, C. R. Field, A. V. Garratt, W. S. Turner, A. J. Meyer.
- North East, Pa.—A. L. Daniels.
- Omaha, Neb.—H. A. Kinney.
- Peoria, Ill.—Lafayette Cole, Martin Kingman.
- Philadelphia, Pa.—A. J. DeCamp, M. D. Law, G. F. Porter, W. R. Hood, J. A. Pentz, T. C. Smith, E. G. Willoughy.
- Pine Bluff, Ark.—J. H. Aitkin.
- Pittsburgh, Pa.—A. E. Carrier, M. Mead.
- Providence, R. I.—M. H. Hartwell, M. J. Perry.
- Pueblo, Colo.—C. M. Davis.
- Quincy, Ill.—A. B. Faunce.
- Red Jacket, Mich.—J. D. Cuddihy.
- Richmond, Mo.—J. R. Hamacher.
- Rutland, Vt.—M. J. Francisco.
- Salina, Kas.—A. Hiller, J. M. Jeffres, Geo. Krueger.
- Springfield, Ill.—A. L. Ide.
- St. Joseph, Mo.—F. A. Chadwick, J. A. Corby, F. D. Rusling, I. I. Dyer, Frank Venawine.
- St. Louis, Mo.—P. C. Burns, F. E. Costello, L. M. Fishback, C. W. Hazeltine, W. H. McKinlock, G. Parker, P. L. Rose, F. H. Pond, J. A. J. Shultz, H. S. Graber, E. Ruebel, S. P. Baird.
- Syracuse, N. Y.—A. P. Seymour.
- Toledo, O.—C. R. Faben.
- Topeka, Kas.—W. W. King.
- Vincennes, Ind.—H. W. Frund.
- Washington, D. C.—Fred Royce, John Lynch.
- Washington Court House, O.—Jerome Penn.
- Wichita, Kas.—J. W. O'Neil, E. M. Reed.
- Wilkesbarre, Pa.—J. C. Bridgeman.
- Windsor, Conn.—A. D. Newton, M. E. Baird.

The following address of welcome was made by Mayor Davenport:

"MR. PRESIDENT, LADIES AND GENTLEMEN OF THE CONVENTION:—To me has been assigned the pleasant and agreeable duty of welcoming you to our city, where many of the most important and interesting conventions that have been held throughout the United States during the years of 1889-90 have sat in deliberation. To none, however, have I extended, in behalf of our citizens a more cordial and heartfelt greeting than it is now my pleasure and privilege to offer you, whose coming has been a source of pleasant anticipations, mingled, perhaps, with the hope that here, in the center of this great American Union, the verge or margin of that border land of science, which Mr. Thurston so graphically depicts, may some day find its beginning, a land where, it is said, the portrait of the sender of each telegraphic despatch will accompany the message, where submarine and aerial navigation will be carried on successfully by the power derived from stored electricity, where the soft light of the firefly or glow-worm will be produced by man, and the direct conversion of heat into electricity will be solved. The result of your deliberations will be anxiously awaited by the whole commercial world, as well as the scientific, because electricity has given an impetus to the former that has driven and impelled it forward with wonderful rapidity and signal success to its present high state of perfection. Its civilizing influences have extended the confines of education, refinement and culture to the uttermost parts of the earth. You, gentlemen, are the exponents of laws which govern one of the most powerful forces of nature under the action of which energy becomes appreciable. You teach us that like heat, light or work, it is measurable and can be produced or converted into other forms of energy. By means of this marvelous agency you have already presented to science most wonderful aids by which she has been able to make visible what has hitherto been invisible; to make audible what has been inaudible, and to discover what has not been dreamed of in the philosophy of mankind, for whether its manifestations be considered under the head of static, galvanic or faradic, it is all electricity—it is all witchcraft, with its future possibilities entirely inconceivable, except to such research as may result from distinguished and able gentlemen as compose this assembly. As we hear of these mysterious currents measured by Amperes, and of the power by which various bodies resist these currents, measured by Ohm we seem to be attaining the condition of life of which Mr. Thurston speaks, or that so cleverly portrayed by Bulwer in his 'Coming Race,' in which all are happy and harmonious, seeming to have reached the millennium. Evil, being held in bondage by the potent 'Vril' wand which gives to all alike motive, defensive and creative power—with also the perfect knowledge of how to use it for the greatest and best good for all. Electricity is our magic 'Vril' wand, and you are teaching us its capabilities. Six years ago it had not been used upon the broad ocean, that difficult and dangerous field of 'warfare.' When the navy department fitted out the frigate Trenton with an electric incandescent plant, the eyes of the world were upon her, eager to see the mooted question settled, as to how the glass bulbs and carbon filaments would bear the firing of the frigate's guns. The three years' successful cruise proved so much to the United States and to those foreign countries, who are learning to follow in her footsteps, that now a man-of-war is not equipped without the incandescent lighting plant and the 'arc' for the 'search,' which reveals, not only the dangers of the surface of the mighty ocean, but pierces the briny deeps, detecting the death-dealing torpedos that have been laid for destruction. This faithful servant of man not only guards the vessel from the inventions of the enemy, but aims and fires the guns, illuminates the sights that the aim may be sure, discharges torpedos, measures her speed, is the most successful motor for submarine boats and renders possible a system of telegraphy by which communications may be flashed against the clouds and understood at a distance of sixty miles.

"We welcome you as true benefactors of mankind, the emancipators of the human race from darkness. What you and those of your profession have accomplished within the past years reflects credit upon your country—borders close



upon the miraculous and entitles you to imperishable honor and renown. I will not detain you in enumerating your achievements, gained by the most faithful and unremitting labor. Cost, or dollars and cents, is the great obstacle in the way of the speedy and universal adoption of many of your most important discoveries and perfected inventions. Electricity to day is at its highest cost, and we look forward to the time when, being cheaper, it will accomplish for humanity all that it now promises. It is estimated that at the beginning of the year 1890 \$600,000,000 was invested in the electrical industry in the United States, and that 250,000 persons depended upon it for their means of living. That 1,000,000 miles of telegraph wires are in operation—enough, it is said, to encircle the globe forty times. Three hundred thousand telephones are constantly talking, and an average of 1,055,000 messages are sent daily, requiring the use of 170,000 miles of wire.

"The longest distance over which conversation is maintained is 750 miles i. e., from Portland, Me., to Buffalo, N. Y. Just how many of the musical kind, that Mr. Bellamy speaks of, I do not know. Four hundred miles of electric railways are in active operation in America. The fastest speed attained in the transportation of passengers has been twenty miles an hour. I believe Mr. Weems has quite recently at Laurel, Md., upon an experimental track, made two miles a minute or 120 miles per hour. There were no passengers upon that train however, it being used exclusively for baggage, which is hereafter to be sent in advance. At your annual meeting at Niagara Falls the statement was made that there are in use in the United States 237,017 arc lamps and 2,704,768 incandescent. I hope that the increase will be so great within the next few years that the various companies will find it possible to furnish light and motive power at much lower rates. Electric light is certainly the only form of artificial illumination not injurious to health, and therefore it is our hope that all classes may soon, in consequences of its cheapness, be enabled to enjoy its benefits. The mystery which seemingly surrounds electric service will, in time, be dissipated, and it will come to be regarded with less suspicion and fear.

"Perfection can not be expected in the use and distribution of such force and power immediately. Danger to human life and property interests are questions in which we are all concerned but it will not do to condemn without comparison and investigation, else we may deprive ourselves of valuable agencies and servants, whom to understand is to bring us health, wealth and prosperity. Immense poles, that make us nightly our most beautiful thoroughfares over which hang a dense mass of wires to obstruct access to our buildings in case of fire and almost shuts out the light of day, will in time disappear. It was necessary that they should precede the subways now coming into use, but not yet, I believe, admitted to be universally successful, though the Bell Telephone company had in 1877, 6,030 miles of wire under ground; in 1883, 8,009 miles, and in 1889 have increased it to 17,038 miles. Taking into consideration, however, the service performed and work done through the means of this unseen power, it is pleasing to note that the casualties resulting from its use are less than from any other source.

"To the future we can only look with wondering eyes and bated breath and to you as the workers of miracles. May your deliberations, gentlemen, while here, be as harmonious as the laws which govern the marvelous and wonderful philosophy of electricity."

The mayor's remarks elicited considerable applause, and in reply thereto, Mr. E. R. Weeks, of Kansas City, President of the Association, made the following address:—

"At our first convention, held in February, 1885, there were eighty-seven delegates, full of enthusiasm for the good to be accomplished. I believe, gentlemen, that they have not been disappointed in the work of this association. As one of the original eighty-seven, I point with pride to five years of broadening and harmonizing influence; and I believe that every central station, every factory, every supply company in the country has felt its impulse towards improvement. To-day, gentlemen, we number 304, representing not only a wider extent of territory than ever before, but all the leading systems of the United States. A more fraternal spirit now prevails between the electric light and power men, and our elder brothers of the telegraph and telephone interests, a pleasant proof of which has been given by the hearty co-operation of their representatives in this city in preparing for the entertainment of the convention. [Applause.]

"The past work of the association speaks for itself; but our number has so increased and our sphere of usefulness has so advanced, that we must look for work of a better character than was possible in earlier days, when most of our members were new to the duties which they had undertaken. We now need work of more direct practical value to central station men, and theoretical work of a higher grade than that of the past, good as that has been. With this in view, we have endeavored to prepare a programme of such importance both practically and theoretically that you will find it good to be here.

"The committee on state and municipal legislation will report the organization of state associations with a view to developing among legislators a full appreciation of the importance and needs of the electrical industries and to present these industries in their true light. The urgent need is for organization along the lines of legislation and popular education. This can be best accomplished by state associations, whose conventions could advantageously take the place of the semi-annual meetings of this association. Ten of these state associations have been formed, and I hope that before the close of this convention, steps will be taken toward the organization of many more.

"The increasing interest in railroad work and the immense field for future development in the motor department will render especially pertinent the discussion by Mr. Sprague, and also the work of the committee or standardi-

zation of potential on electric street railways, the report of which will be submitted through its chairman, Mr. Lynch.

"As the growth of our industry must be chiefly in the direction of incandescent light and power, the discussion to be presented by Mr. Field is of the greatest importance, both to central station men and to all who desire electric service in their homes.

"The watchwords of the future are certainly economy of fuel and perfect insulation, and while there may be improvements in designs for apparatus, and in methods and means of distribution, and while we still hope for the direct conversion of the energy of coal, the advance of the immediate future should be in the direction of economizing present waste, rather than in the discovery of new facts or principles. [Applause.] Americans are proverbially prodigal, and there is an absolute and growing need that waste and loss should be arrested. While the demand for the necessary elements is increasing with the population, the supply of many of those elements are steadily diminishing. Messrs. Babcock and Suckles will doubtless point out lines of economy in the department of steam engineering, and Mr. Smith will present for our consideration another phase of the same question—"A Universal System of Central Station Accounts." The many problems arising in the electrical and mechanical departments of the operation of central stations have left this question to general neglect. But now that we are becoming passably familiar with the tricks of our apparatus attention is more and more directed to data for comparisons with a view to economic methods.

"The topic of the hour is certainly safety. It would seem that in view of the relatively small number of serious accidents connected with electrical industries, we have grounds for some impatience with the present outcry against electricity as a dangerous servant. It is true that compared with those which have accompanied the introduction and use of steam and gas, the number of accidents in the use of electrical apparatus is very small. But in this age comparative rates will not be accepted as answers; the people have a right to demand that devices for public safety keep pace with developments in other directions. The discussions of Professor Thomson and Messrs. Haskins and Harber will present this current topic in its various phases. I trust that each speaker will enforce the importance of good construction and maintenance on the part of producers, and proper inspection on the part of the municipality.

"It is hoped that the committee on underground conduits and conductors will be able to report some facts regarding the actual operation of high pressure currents under ground. Thus far discussion of this topic abounds in theory and speculation, but contains little experience.

"During the past twelve months there has not been only a greatly increased activity in the electrical industries abroad, but many millions of foreign money have been invested in the electrical properties of America. It is also worthy of note that our brethren in Great Britain have set the example of adjusting differences amicably, instead of carrying litigation to the court of last resort. Such a policy in America would not only have saved hundreds of thousands of dollars now charged to profit and loss, but would have greatly enhanced the value of electrical securities. The past year has furnished instances in which the value of local electrical properties has been greatly depreciated through the invasion of territory already fully occupied. This policy is shortsighted. Prices in most cities are fair and just, both to consumer and producer. To depreciate them will not only ruin the business of pioneer companies who have invested large sums, and borne the brunt of introducing a new and valuable industry, but can not fail to result in great loss to the invader.

"Although electric lighting in this country has seemed to receive a check, a look ahead would not be discouraging. The law that 'action and reaction are equal and in opposite directions' applies not only to mechanics, but to public opinion. As America is the birth place of the commercially successful electric light, and as Americans are the foremost people of the world to recognize improvements, we may well believe that with proper attention on our part to our duties to the public, the present popular and largely sensational agitation against us will give place to a feeling of confidence. In the mean time, let the outcry teach its proper lesson to all engaged in the electrical business."

Secretary Allen V. Garratt, of New York, then called the roll of associations, companies, firms and individuals, members of the National Association, occupying some time.

Mr. Garratt then read his report as secretary and treasurer, showing a balance on hand of \$610.17.

"The Association," he said, "has now a larger income than ever before. There is now due about \$2,500 from members, who evidently expect to retain their membership."

The report was unanimously accepted and adopted.

The secretary read a communication from the Commercial Club inviting delegates and their friends to attend a reception in the evening; one from the Chicago, Milwaukee and St. Paul, extending the courtesy of a special train to Excelsior Springs; one from the Excelsior Springs company, extending the courtesy of The Elms, and one from the Missouri and Kansas Telephone company, offering courtesies.

It was Mr. George H. Foote of the Chicago, Milwaukee & St. Paul, however, who brought down the house.

"Our train," he said, "will take you to the

fountain of youth, where the bubbling waters bring the flush of health to the face, where blue birds twitter in February, where there is health in the very air from the life-giving waters—we will take you where you can drink."

And the convention decided to go, to the last man.

Invitations to visit the soldier's home at Leavenworth, and to attend the performance at the Warder Grand, Friday night were referred to the executive committee. A committee on credentials was appointed to meet at 3 o'clock in the afternoon, and to report in the morning. A committee was appointed to draft resolutions on the deaths of C. McIntyre and Miles W. Good-year.

Adjourned till Tuesday morning 9 o'clock.

### WEDNESDAY'S SESSION.

Pursuant to adjournment of the previous day, the Convention came to order at 9:30, in the Music Hall. A communication was read by the secretary, from the Metropolitan Street Railway company, which extended the courtesy of all its lines to the delegates, and said that conductors had been directed to recognize badges in lieu of fare. It also tendered a special excursion over the Armourdale electric line. The offers were accepted with applause.

The State Association of Architects, in session at the Midland, invited the delegates to inspect the display of architectural drawings in parlor S of the Midland. The executive committee was directed to answer the communication and reciprocate courtesies.

Mr. George D. Phelps, of New York, on behalf of the committee appointed to memorialize Congress on the abolition of custom duty on copper, then made the following report:

The committee appointed at the last meeting of the National Electric Light Association to petition the proper committee of congress for the abolition of duty on copper, appeared at Washington January 16, through Mr. Phelps, who presented the following petition to the committee on ways and means with the subjoined address:

Petition to the Honorable Committee on Ways and Means.

House of Representatives, U. S. A.  
The subscribers were appointed a committee to petition your honorable body for the abolition of duty on copper ingot, plate bars, rod and wire. We represent the National Electric Light Association, a body composed of representatives of electric lighting companies throughout the United States, and also of manufacturers of and dealers in electric lighting apparatus and supplies.

The resolution appointing this committee was passed without a dissenting voice. We therefore have the honor to present this petition, earnestly requesting that the action asked to be taken as a measure which will be approved by the great body of users and manufacturers of copper.

CHARLES A. BROWN,  
GEORGE M. PHELPS,  
J. F. MORRISON.

The National Electric Light Association consists of corporations, firms and individuals owning and operating stations and plants for the distribution of light and power by electricity.

At the time of the last convention of this association, August 6, 1889, the capital then invested in the industries above named was estimated, from the statistics collected by the secretary of the association, to be not less than \$275,000,000. This sum represented mainly electrical apparatus and electric conductors for the supply of 238,000 arc lamps and 2,700,000 incandescent lamps, in all which apparatus and conductors copper is an indispensable and chief material. In the total cost of electric plant for light and power distribution, it is estimated by competent experts that from one fourth to one-third is expended for copper.

The foregoing figures and statements sufficiently indicate the magnitude of the interest of electric light and power companies in the price of copper.

In the opinion of the petitioners the proposed abolition of the copper tariff does not touch the question of protection to the American industry. The duty on copper appears to be wholly superfluous as a protection to American producers of that metal. The United States not only produces more copper than it consumes and consequently exports that metal, but it possesses the richest and most easily worked copper mines in the world, and its mining companies produce the metal and put in the market at a lower cost than is possible to the Spanish or Chilean miners. Obviously the American producers of copper require no duty to protect their domestic market and their exports of copper furnish sufficient evidence of their ability to meet competition in foreign markets.

The existing duty is of no appreciable value to the national treasury, because copper is not imported in any considerable quantity. As a source of national revenue the copper tariff is practically useless and the returns from it could not be increased materially under the conditions of production throughout the world by any modification of the rate of duty if the government needed increased revenue, which it confessedly does not.

It would appear, therefore, that the duty on copper can only be efficient in enabling the mining companies and dealers in copper to establish and maintain excessive prices through combination for that purpose. It is believed that the United States duty of 4 cents per pound was a consid-



erable factor in the operations of the syndicate, established in France in the autumn of 1887, and which syndicate, aided by its agreements and contracts with copper mining companies in this country, succeeded in controlling the copper production and markets of the world for more than a year, doubling, for a considerable period, in London and New York, the price existing just previous to the beginning of its operations. This was effected, moreover, in the face of an abundant supply of the metal. For some months after the break down of the French speculation the American companies maintained the price in this country considerably in excess of that of European markets.

Touching the relation of the duty on copper to combinations for maintaining excessive prices, the following quotation from editorial in New York *Tribune*, May 15, 1889, is subjoined:

The mine owners have publicly stated that they are able to produce more than all the copper this country consumes, and a large part of it at a cost not exceeding 6 cents per pound and that they propose to the French bankers, who hold an enormous unsold stock, to fix the selling price at about 15 cents per pound—more than double the cost. Nothing need be said about the right of the producer to get a profit of more than 100 per cent. on his copper, provided he is not a beneficiary of a national policy intended to protect and encourage American productions. But the mine owners are beneficiaries of that policy and owe to the public a certain consideration and service in return. If they enter into a combination for the benefit of foreign speculators and bankers against the interests of American producers, the duty on copper may not last long. \* \* \* There will in all probability be a revision of the tariff next winter, the party in power being anxious to defend all industries that need and merit defense or where it appears to be needed or where it seems to be deserved. Combinations of speculators to corner the markets of the world are not highly popular, and will not appear to members of congress to merit particularly favorable consideration. Under such circumstances the demand for a removal of the duties on copper ores, pig and bars will be difficult to resist. It is safe to say that, had the Mills bill proposed no change more unpopular or unobjectionable than that, its public support would have been incomparably greater.

In short, and to recapitulate, in the opening of the National Electric Light Association the duty on copper, being useless for revenue and unnecessary for protection, should not be suffered to remain on the statute books of the United States, since its only remaining function is to serve as an ally to the promoters of combinations for putting up prices, a process to which the government should not lend its assistance.

The committee has circulated an auxiliary in support of the petition presented in behalf of the association. It has been intended to solicit the signatures of all companies, firms or individuals engaged in electrical industry and to offer opportunity for signing to all other persons accessible to the committee who are in sympathy with the proposed measure.

On February 8th, 440 signatures to such auxiliary petitions were forwarded to the committee on ways and means of the house of representatives.

Your committee is still engaged in circulating copies of the auxiliary petition and hope to collect several hundred more signatures.

The committee would earnestly request any members of the association or others inclined to sign the petition who have not received a copy to address either members of the committee, viz.: Charles A. Brown, 227 South Clinton street, Chicago; George M. Phelps, 150 Broadway, New York; J. F. Morrison, 15 South street, Baltimore.

Mr. Phelps, then added:—"I wish to suggest further that members who feel deeply interested in this matter would, I think, contribute to the success of the petition by addressing communications to their several representatives in the national congress. It is somewhat problematical, I think, whether any discussion of the subject of revenue at all will be permitted to take place on the floors of congress this session. But, if such a discussion can be brought about there, it is the opinion of your committee that the success of their petition is exceedingly probable. There is practically nothing to be said in favor of retaining the duties on copper. I have not heard a word in defense of it. The only persons who have been at all disinclined to sign the petition have been those who have said substantially: 'Yes, it is all right, the duty on copper ought to go; but we make something else, and our friends make something else that are protected by tariff duties, and we do not want this thing stirred up.' We feel that the greatest difficulty will be in getting the thing 'stirred up.' If it can be 'stirred up' and brought to the attention of the national congress on the floors of the house of representatives, it is my individual opinion, and I think the belief of the rest of the committee, that the copper tariff will not last long. All those who are in sympathy with the measure will contribute to its successful issue by addressing their members in congress, or any congressmen or senators to whom they have access in any way. I ought to say I am but one member of the committee present, Mr. Brown, the chairman is unable to attend, and Mr. Morrison, we all know, is unfortunately prevented from being here. I have made out this report after conference with Mr. Brown, but have not been able to see Mr. Morrison.

"I ought to say further, perhaps, as a matter of record, that there was no appropriation made for the work of this committee. Your committee has expended a considerable sum of money and a great deal of printing and postage was required. In due time when we are through with our work we may present, for the information of the association, a record of this matter."

President Weeks:—Gentlemen, this subject is a matter of great moment. Aside from its national, I might say international interest, it is a matter that comes right home to everyone engaged in the electrical business; and it illustrates very nicely the community of interests that prevails, and we should all appreciate and understand it, whatever

affects the manufacture of electrical apparatus affects the user of that apparatus and what affects the user of that apparatus must necessarily come right down to the user of the product of that apparatus—the general public. I repeat, gentlemen, that this is a very important question. The report is now before you; what is your pleasure?"

On motion of Mr. A. J. DeCamp, the report was received and the committee continued.

Secretary Garratt read the report of the committee on underground conduits and conductors. It was in the form of a letter to President Weeks, stating that no quorum had come together. The committee was discharged and a new one ordered appointed.

The committee on standardizing of potential on electric street railways then submitted the following report:

*Gentlemen of the National Electric Light Association:*

In behalf of the committee appointed at your last meeting, for the standardizing of potentials for electrical apparatus for street railway systems, I would present to the Association the following report:

It was deemed advisable by the members of the committee to send out a circular to all railway companies operating their systems of car lines by electricity, notifying them of the appointment of this committee, and asking not only their co-operation, but also drawing their attention to a number of questions that we desired they should reply to. Acting upon this conclusion the committee drew up and mailed to all these companies the following circular:

*Gentlemen:*—At the semi-annual meeting of the National Electric Light Association, held at Niagara Falls, on August 6th, the following resolution was offered and adopted:

"WHEREAS, it is the belief of the members of this Association that the electric motor service upon street railways will require a service of electric current for the motor that will be reliable and constant, and that the various electric light stations are capable of generating and distributing such current.

*Resolved*, that a committee of three be appointed by the president, who shall endeavor to make such arrangements with the manufacturing companies, that they should adopt some standard potential to be used upon the various railways. The committee also to collect such data regarding the supply of current to railways as may be deemed of interest to the Association."

The President appointed Messrs Eugene T. Lynch, Jr., of New York, T. Carpenter Smith, of Philadelphia, and Marsden J. Perry, of Providence, as members of that committee.

It has been thought advisable to collect and compile the opinions and experiences of such street railways that have adopted electricity as a motor power. Will you, therefore, kindly fill out and answer such of the following questions as you feel you can answer?

1. What system do you use?
2. What proportion of your cars are equipped with motors?
3. Do you generate your own electrical power, or are you supplied by an electric light station?
4. What proportion does your greatest average horsepower in use bear to the total horse-power of engines and boilers which you have installed?
5. What is the voltage or pressure of your generators?
6. Is there any other railroad in your town using an electric system? If so, what system do they use, and do you know the pressure at which they run?

We have received replies from eighty-five per cent. of all the electric street railway companies. They have one and all showed every disposition to give us full reports upon the questions that we have asked them, and have stated that they would afford us every facility that lay in their power, and that they desired us to convey to the National Electric Light Association their hearty endorsement of this plan.

We think it advisable to divide our report into three parts: First: A statement of the conditions under which the various railways have been operating up to the present time. Second: The report of your committee upon the arrangements made with the manufacturing companies. Third: A set of statistics carefully compiled from reports made by some of the most prominent central stations, showing the advantages that will accrue to the investor by the combined operation of the electric light and electric street railway interests, working under the agreements that have been promised to your committee.

First. Under the first question we do not desire to give any statements regarding the number of railways that may be operated by any particular company beyond the fact that fully ninety per cent of all the railways now in successful operation are operated under the systems controlled by the Thomson-Houston and Sprague companies.

In answer to our second question we find that at least three-fourths of the railways have equipped all their cars with motors, and that the sizes of the motors upon the cars vary from seven and a half to fifteen horse-power.

Only nine electric light companies have been brave enough to agree to supply the street railway companies with their power, although in nearly every case when the railway was in operation, there was at least one central station company who could have contracted to supply the necessary current.

The answers to the fourth question give to your committee the information that will prove of value to the Association.

On all railways operating over fifteen cars, only one-third of the total horse-power with which the plant has been equipped has ever been called for at one time. On all roads operating between five and fifteen cars the greatest average load has not reached fifty per cent of the total horse-power, and upon smaller roads the average load has varied from fifty to eighty per cent of the total horse-

power. All roads that have met with heavy grades have raised the average very considerably.

We find that the potential varies from 220 to 800 volts, the greater number of companies however report using a potential between 450 and 550 volts.

Our sixth question was directed partly as a check upon our being furnished correct information upon the names and locality of the various roads, but mainly to ascertain whether an opportunity was afforded to operate several street railway companies from the same central station plant.

The answers to this have been many and curious. In some cases they have disowned all knowledge of the existence of any other company, and in nearly every case they seem to be imbued with the rivalry quarrels or misunderstandings of the various patent or manufacturing companies whose apparatus they are using. They agree, however, that they would be willing to use the power supplied to them from some central station, provided, that they be assured by the company who equipped their road that the potential of quantity of current used would not be detrimental to their apparatus.

Copies of the circulars, together with a letter explaining more fully the plan suggested by your committee, were sent to all the manufacturing companies. They were also requested to furnish the committee with a list of the particular railways operating under their systems. After much correspondence and many personal interviews your committee would announce that they have written authority from both the Thomson-Houston and Sprague Street Railway companies to make the statement on behalf of their particular companies that they will agree hereafter to use a standard potential of five hundred volts upon all electric street railway equipments that do not require any special apparatus for their successful operation.

In recommending electric light companies to add to their regular central station business the business of furnishing power to street railroads, we wish it fully understood that we do not base any hopes of profits to be made upon the old time idea that the same machinery can be used for furnishing light at night and power in the day time. This specious argument has led many companies into large expenditures for motors, etc. and they have discovered later that it costs very nearly twice as much money to run the same machinery night and day as to run it at night alone, and that it pays better in the long run to have an entirely different class of apparatus to produce light and power.

The true direction from which returns may be expected in the massing in large stations of the generation of electricity for both light and power, is found in the fact that electric light stations to be sure of a continuous running, requires a reserve of from fifteen to twenty-five per cent of its average load in boilers, engines and dynamos; the per cent being larger in small stations, and diminishing as the station increases in size.

This same reserve in capacity is required for the power station, but on street-car work in most of the stations hitherto installed, this percentage runs very much higher, being from 50 to 80 per cent. It will be manifest to every one on a little reflection, that a station which is generating current for two street cars, is compelled to have power enough provided to allow of the throwing on at the same instant of both these cars, that is to say, generating capacity of fully twice the average amount of power, or 100 per cent reserve; as more cars are added, the chance of any particular number being thrown on at one time becomes less and less, until in a station operating two hundred cars, a single spare generator to take the place of any one which might be disabled, would probably be all the reserve needed. This feature is shown very clearly in the running of the ordinary three-wire electric station, where when the total load is light a few lights thrown off or on either side will make a big difference in the balance, but as the total load increases, the number of lamps thrown off or on either side at any one instant is so small a percentage of the total load that the station needs practically no balancing. Now if any one station supplying electricity for all purposes in a town, we have say 25 per cent reserve in boilers, and 25 per cent reserve in steam engines in excess of the average load, we shall only require to place 25 per cent reserve, each, on electric light dynamos and power generators to have practically the same result, as though we had two complete and separate stations for electric light, and for electric power, each with its proper reserve of 25 per cent extra in engines and boilers and dynamos.

Another important point to be considered, and one well worthy of consideration by electric light stations, is, that in many cases they could furnish this current delivered at the walls of their stations; that is the car company will take care of its overhead lines and connections, and the electric light companies be paid a rental simply for the electricity delivered to the car companies lines.

As an instance of what may be done in increasing the output of a station, without a corresponding increase in expense, we quote the case of a small station, which as nearly as can be determined from results, shows the following condition of affairs:

The station increased its business in 1889 over 1888, 23 per cent, and in the same time the total expenses including the extra line work and distribution expenses 10 per cent, which 10 per cent meant 10 per cent increase in running expenses, and 10 per cent in fixed expenses. The company contemplates a further increase of 27 per cent on the same basis, this increase however, being for power furnished alone, without any line work involved, the most careful calculation shows that this will only increase the present running expenses 10 per cent, without increasing the fixed charges at all.

In 1888 the proportion of fixed charges to running expenses were 25 per cent, and 75 per cent respectively of the total expenses. In 1889 this same proportion held good, each having been increased 10 per cent, as above stated, and the total expenses having increased the same amount. The further expected increase being 10 per



cent of 75 per cent, will mean an increase in the total expenses in 1890 over 1888 of  $17\frac{1}{2}$  per cent, while in the same time the total output of the station, and consequent gross receipts will have increased 50 per cent.

These figures are all taken from the case of a small station, with a total output of some 300 horse power and a fresh increase in this station (above this point) will result in an entirely different condition of affairs, so that a readjustment will take place in the proportion of fixed expenses and running expenses, we therefore present the report of another station which is operating 1,200 horse power, in which the total operating expenses are divided into 80 per cent running and 20 per cent fixed. On increasing the station to an output of 1,800 horse power, the increase to be entirely in the furnishing of power, the increase on total operating expenses would be about 14 per cent, and the ratios of fixed and running expenses would be as 15 per cent and 85 per cent.

The report of another large central station operating at least 2,500 horse power has been divided somewhat differently. The fixed charges are 14 per cent of the total expenditures. All labor and pay rolls amount to 41 per cent, and all material such as coal, carbons, lamps, wire, oil, etc., amount to 45 per cent.

Taking in account all their past calculations and experiences, they are very confident that they can operate at least double their present output, be it light or power, at one-fifth more for fixed charges, one-third more for all labor and pay rolls, and say three-fourths more to their present material item, making a total additional charge of say 50 per cent upon their present expenditures and giving them in return at least double the gross income. As stated before it will not be found advisable to calculate upon using the same engine, boiler, and dynamo power for the double service for lighting at night and power during the day time except, of course, in some few isolated cases.

The great saving for the central station company lies in the reducing in labor and fixed charges and also that the reserve power for one will suffice for the other. Your committee feel that a great step has been taken in the right direction in securing the indorsement and co operation of the largest and leading companies, and they would suggest to the association that some measures be taken to secure from the stationary motor companies the adoption of some standard potentials for their use upon constant potential circuits.

EUGENE T. LYNCH, JR.

There was no discussion over the report of the committee, the convention deeming it better to delay it until after Mr. Sprague's address on "Electricity, as Applied to Street Railways." The committee on the standardizing of potential of street railways presented its report as follows:

Mr. P. H. Alexander, of New York, presented the report of the committee on harmonizing insurance and electric interests. The committee had had a great deal of correspondence and it repeated the recommendation of last year.

An amendment to the report was offered in effect that the institution known as the New England Electrical Exchange should be extended throughout the country and divided up as follows: The southwestern and a middle state, the northwestern and Pacific coast, these organizations in return to be controlled by a central body to be denoted the National Electrical Exchange. The objections offered to this plan were that inasmuch as the insurance companies themselves assumed the risk and were paid for doing so, it remain with them to inspect all interior wiring or installations whether operated from isolated plants or central stations; that insurance companies in the past had been negligent in not availing themselves of the ample opportunities offered them for obtaining a thorough knowledge of everything necessary to enable them to do this work for themselves; that the time had come when this business with its investment of \$2,000,000 capital and operating 238,000 arc lamps and more than 2,500,000 incandescent lamps, should be better known and its progress no more hampered by numerous restrictions which are not common to other businesses; that the electric light business should not be singled out and made the sole exception to the ordinary policy of insurance offices. Inspectors of these offices it was urged should be instructed by associating themselves with first-class electrical engineers, such as can be found in any fair sized community. They would thus put themselves in a position to judge accurately of the safety of any stallation.

Mr. George Cutter, of Chicago, opened the discussion. He felt a hesitancy, he said, in speaking for the electric light men of the west, but in this section there was a demand for harmonizing the two interests—insurance and electric light—and he advocated it warmly in a long speech.

Mr. Smith, of Philadelphia, followed, holding that the insurance should be made to look after the safety of electric wires and not electric light companies.

Mr. M. J. Francisco, of Rutland, Vt., advocated combining the two interests and forming a national exchange, which should be divided in sectional associations on the plan of the New England insurance exchange, which employs an expert to determine risks. His association would take the place, or be on a par with the National Board of Underwriters.

Mr. Lockwood, of Detroit, Mich.; Vice President DeCamp, Mr. Perry, of Providence, R. I.; Mr. Armstrong, of Camden, N. J.; Mr. Alexander, Mr. S. E. Barton, of Boston; Mr. Williams, of Ohio, and others spoke at length. Finally the report was accepted, the amendment being lost.

Following this Mr. C. J. H. Woodbury, of Boston, read a paper on the "Construction of Central Stations." He submitted a number of general suggestions for stations which embodied the merits of convenience, slight need of repairs and resistance to fire. Mr. F. E. Sickels then read an admirable paper on "The History and Theory of the Steam Engine."

(Adjournment.)

#### THURSDAY'S SESSION.

Immediately after calling the convention to order President Weeks announced that the Interstate Rapid Transit company had tendered the use of all its lines to delegates who desired to ride over them, and the association badge would be recognized as a pass over the entire system until the convention adjourned.

The first paper to be read was prepared by George E. Babcock, of New York, on "The Economical Generation of Steam for Electric Light Stations," and was read by George E. Palmer, of Chicago. The paper illustrated the difference in the construction of boilers to be used in generating steam for electric light stations as compared with those for ordinary manufacturing plants. For electric light power the work of the boiler is crowded into a few hours time, and boilers to be economical should be so constructed as to admit of crowding for a short period. This theory was backed up by statistics and practical illustrations.

At the conclusion of the reading of the paper President Weeks announced that the subjects brought before the convention by the papers of Mr. Babcock on the "Economic Generation of Steam," and of J. H. Woodbury on "Central Station Construction," read at Wednesday's session, were open for general discussion. Mr. Sickles spoke of the advantages afforded by flat stale service boilers.

T. Carpenter Smith, of Philadelphia, took issue with him and maintained that cylindrical surfaces were far preferable for practical use.

C. J. Field, of Brooklyn, also took part in the discussion and made some excellent points in regard to boiler construction.

M. T. Law, of Philadelphia, thought that Mr. Woodbury, in his paper, had neglected to treat of the dangers from fire by the use of waste beneath dynamos on floors necessarily made of wood. He argued that electric light stations were constantly in danger of fire from this source, and his point was followed up by S. E. Barton, of Boston, who called attention to the oil soaked floors of the electric light stations adding increased hazard to the fire risks. C. R. Seeley, of New York, and M. J. Francisco, of Rutland, Vt., also took part in the discussion.

C. J. Field, of the Field Engineering Co. of New York, read a paper on the development of generating stations for incandescent light and power. He said:

"I desire to present to you a brief review of the present and prospective future of central power plants in the larger cities, taking as an illustration one of the more recent types, describing its general arrangement, then proceeding to the consideration of its initial cost, earning capacity, output, operating expenses, economy, and in conclusion, trying to indicate the immediate future development in this class of work. The immediate points to be considered and carefully weighed in the designing of a central power plant for a large city are many and they should receive careful survey before any work is proceeded with. We will briefly summarize them as follows:

"First—Recognition of the importance of safety and reliability in operation.

"Second—Obtaining the true economy of output under all conditions.

"Third—Installing of plant in a building entirely suited to the working of same and as far as human ingenuity can provide proof against destruction.

"Fourth—Adaptability to proper and economical working of the plant.

"Fifth—Division of the generating power into the proper number of units for the safe and reliable operation of the plant.

"Sixth—Flexibility of system; that is, adaptation to furnishing current for light, power and other sources of revenue, the obtaining of the largest return per dollar invested, and not carrying to excess for the mere sake of engineering by any part of the plant for the obtaining of proper results therefrom.

"Seventh—Not installing the plant for mushroom growth, but laying it out for comprehensive business, thereby securing, at as early a date as possible, the entire confidence of the invested capital.

"A true and careful consideration of these points will prevent trouble later on. Much of the trouble of the stations at the present time, in their standing with the community, is due to neglect of this point, and the majority of their failures as well. We have got to recognize the fact that the public, to a certain extent, have become prejudiced, in a measure, somewhat unjustly, but this is all the more reason for better and more conservative management, and giving them good construction. No more inviting field is offered for either investing capital or good engineering than central station for lighting, power and railway work."

He then described a representative station costing \$426,000, and with a capacity of 20,000 lights. He advocated an underground system as the one best adapted for use and as the coming system. In closing he paid this tribute to Edison:

"I would only add a tribute to the powerful and master mind whose work, from the commencement of this field of central station distribution, has covered the leading problems and points, and whose ideas to-day represent much of the good and very little of the bad problems which we have in this work. I refer to Thomas A. Edison, whose work, commencing in this field on the old Pearl street station in New York, over eight years ago, when the majority doubted, and but few believed in its successful carrying out, and while we find that station until within the past few months, when it was partially destroyed, successfully working, and even antiquated as it was, earning large dividends. He has still continued actively to impregnate his ideas on the work from that day to this, although he has not taken such an active part in its carrying out, but I think we may see him at no distant day, again taking a hand in this work, and bringing forth many new ideas in advancing the progress of the future."

The paper was discussed by Messrs. Seemore Munsey, Alexander DeCamp and Armstrong. It was voted to postpone a general discussion of the paper until after Mr. DeCamp had read his paper on "The Cost of the Products of Central Stations."

T. Carpenter Smith of Philadelphia then read a paper: "A Universal System of Central Station Accounts." The paper detailed a thorough system to be used in keeping accounts and the discussion which followed favored his views.

(Adjournment.)

#### AFTERNOON SESSION.

In the afternoon Vice-President DeCamp, of Philadelphia, read a paper on "The Cost of Products of Central Stations." He gave a system of bookkeeping that he had used for eight years that was very comprehensive. By his method the cost of running a station could be accurately kept as to each light.

George M. Phelps read the following telegram:

"I have just returned from Richmond, where a bill for the restriction of voltage in Virginia has been reported adversely by unanimous vote of the senate committee after two days' argument. It was supported by Edison in person and the electrical executioner. It was opposed by Westinghouse representatives, aided most effectually by local companies at New York, Alexandria, Petersburg, Lynchburg, Fredericksburg, Richmond, Liberty and others."

R. W. POPE.

The reading of the telegram was loudly applauded.

M. D. Law, of Philadelphia, read a paper on "Nine Years with the Arc Lamp."

E. F. Peck's paper on the results of his tests with arc light carbons, was read by Major Ransom.

In the discussion that followed, some one asked if it was true that there was an arc lamp at the centennial. Mr. DeCamp said he was there a hundred times and had never seen it. He had often heard and read the story, and wondered how it started.

The secretary said he had seen a rude arc light in 1865 in Boston. Finally a delegate came to the front and said he had seen the light at the centennial.

The next paper was by H. W. Pope, of Elizabeth, N. J., entitled, "How our Paths May be Made Paths of Peace." He closed his paper by saying:

"It should be the aim and policy of all electrical corporations to constantly improve the condition of the poles and lines, giving as much attention to their strength and



beauty as to their perfection electrically. Every day you delay these improvements you encourage adverse criticism and hasten adverse legislation, and subways and underground conduits are not pleasant things for the strongest of us to contemplate. A policy such as this, and a vigorous state organization of electric lighting companies, will protect our interests from any severe measures at the hands of the general public."

Then followed the reading of a paper prepared by Prof. Elihu Thomson, of Lynn, Mass. The subject was "Safety and Safety Devices in Electric Insulation." In his paper he said:

"The development of the electrical arts, particularly in the direction of lighting and motive power transmission, has been very great in the past few years. It has brought with it a demand for very much work of a novel character, as regards the details of plant and methods of installation. It has also entailed in many cases elements of risk to life, and danger of fire. There can be no doubt, however, that electricity, as an agent in itself, is not to be charged with bringing about the results for which recklessness in its use is sufficient to account. That under favorable conditions for discharge through a person's body, electric currents of comparatively high pressure may injure or kill, is not to be questioned for a moment, and I have no sympathy with any effort tending to give the impression that they are absent when, in reality, they exist. Nor have I any sympathy with efforts to exaggerate such risks, efforts that have not been wanting, as is well known. There can be no question that the risk to life from shocks, even with bad insulation, would be removed by using high potential currents, and there can be no question that the shock from certain kinds of currents, as the alternating, is much less safe than from continuous currents of the same pressure. Nevertheless, I am just as firmly convinced that the fire risk is very much less with the alternating than with the direct currents. Would it be possible to work successfully, using only low potential currents of either character? Would we, for instance, be able to utilize water powers for lighting without employing pressure of potential sufficient to convey the energy to a distance over a conductor of moderate cost or con-prohibitive cost? In most cases we would certainly not be so able. If the great natural resources in water powers are to be developed, if ever we are to accomplish the great saving in fuel that results from the use of one large instead of several small steam plants, it will be by the employment of comparatively great electrical pressures for the conveyance of energy to distant points. And in this connection it must not be forgotten that even with the very low pressure currents, safety from fire risk is only to be secured by careful construction and supervision, and that fire involves personal risk."

Professor Thomson then discusses the alternating system, and states that the outside wiring in that system undoubtedly carries a current that will give a fatal shock, but states that the outside and inside wiring can be certainly separated so that no possible shock can be obtained by those using the light, and that it is impracticable to furnish the incandescent light at great distances on any other system.

The report of the committee on electrical data was read by the secretary. It showed how many pamphlets had been distributed, and the amount of literature given out. The report was adopted and the committee ordered continued. Vice-President DeCamp introduced a resolution, which was adopted, petitioning both houses of Congress to appropriate \$50,000 to aid the census commissioner in securing electrical statistics. An agent had been appointed—but he had little funds at his disposal. What the electrical industries of the country wanted, Mr. DeCamp said, was statistics in detail in regard to underground and aerial wire construction cost, the voltage and pressure used, the number of arc lamps in use, the kind and number of electric motors, the income and expenses of operating electric light plants, the casualties resulting from electric lighting as compared with other means of lighting. The resolution closed with a vote of thanks to Census Commissioner Porter.

W. H. Lawrence introduced a resolution asking railroad managers to change the classification on carbons from first and third to fourth and sixth classes, which was adopted.

A motion was then carried that the president appoint a committee of five on nominations and place of holding the next meeting, and a resolution was carried that the next August convention be held at Stockton Hotel, Cape May.

President Weeks then announced the nominating committee as follows: Messrs. Huntley, Francisco, Peck, DeCamp and Beebe.

(Adjournment.)

#### FRIDAY MORNING SESSION.

President Weeks called the convention to order at 9:30 a.m. C. R. Huntley presented the report of the committee on nominations, as follows:

President, M. J. Perry, of Providence, R. I.

First Vice-President, E. W. Maher, of Albany, N. Y.

Second Vice-President, C. L. Edgar, of Boston, Mass.

Executive Committee, C. R. Huntley, chairman; E. R. Weeks, Kansas City, Mo.; James English, New Haven, Conn.; S. A. Armstrong, Camden, N. J.; M. D. Law, Philadelphia, Pa.; M. J. Francisco, Rutland, Vt.; A. F. Mason, Boston, Mass.; John A. Seeley, New York; H. K. Thurber, New York.

DR. A. F. MASON: I desire, sir, in a word of explanation, to make a nomination. I think that every member of this association recognizes, with something akin to gratitude, the very felicitous, the very remarkable services of the present president of the association. I believe that I do not speak for myself alone, but for every member of the association, when I say that we have had an exceptionally profitable as well as enjoyable meeting here in Kansas City; and that very largely this is due to the efforts of our president, E. R. Weeks. I, therefore, desire to put in nomination for the presidency of this association for the ensuing year, E. R. Weeks, of Kansas City.

A. J. DeCAMP, of Philadelphia: That nomination being made, outside of the committee, I think it requires a second. I arise to second the nomination. Whatever we may be glad to do as a body of men, we certainly owe one thing, and that is a proper appreciation for those who have already served us. I think I am justified in saying, of all the meetings that this association has held, there has been evidence of a healthy growth. But, like the growth of our country, we have in that total growth made a stride. The step from our last meeting to the present, comes under that class: It is a stride! This is the most largely attended meeting that we have had. There has been the greatest interest taken in it, and our work has been of the most practical kind, and I think that it has been due very largely, if not entirely, to the efforts made by the president of this association. He has been, during the last six months, at work constantly, or the results that we see could not have been accomplished. I would be glad to have him fully appreciate the feelings of this association.

PRESIDENT WEEKS: Gentlemen, your action in this matter is gratifying to me, in that it evinces your approval of the administration just drawing to a close. Next to the consciousness of having done one's best, comes the approval of one's friends and associates; but, gentlemen, my views of the presidency of this association have not changed. It is my opinion that the president of the National Electric Light Association should be a citizen of one of the larger Eastern cities, one of the great electric centers, if I may so speak, of the country, where he can carefully watch all movements affecting the interests of the industries that we represent. Kansas City is not such a center, although Kansas City will sometime undoubtedly be just such a place, and the place where, for this very reason, the president of some future convention of this association might well be located; it is not so now. I, myself, have, during my administration, felt frequently the disadvantage of distance; and if the interests represented in this association have not suffered, it has been due largely to the zeal and support of the Eastern members; it has been due largely to the vigilance of our secretary and the earnest watchfulness, to the zealous application and industry of our Eastern committee. The success of this convention, gentlemen, which has been so kindly attributed to me, is due very much more to the combined efforts of those gentlemen who have supported the administration, and have looked out for the interests of the association so carefully.

For these reasons, gentlemen, I feel, much as I appreciate the honor that you offer me, that the best interests of this association require the election of the officers nominated by your committee. In the expression that has been made and in the increasing prosperity of this association, in the strengthening of the association throughout the West, which was the reason for my acceptance of this office, I find my reward. I thank you, gentlemen, for your offer, but for the reasons stated, I must respectfully decline the nomination.

E. A. Armstrong stated that it would be unwise, both in justice to the duties of the position, and unwise from a personal standpoint, to accept a place on the executive committee. He suggested the name of Mr. Burleigh as a substitute.

A motion to substitute J. J. Burleigh in place of Judge Armstrong on the executive committee was then put and unanimously carried. The secretary was instructed to cast the ballot of the association for the officers and members named in the report as amended.

#### APPLICATION OF ELECTRICITY TO RAILWAYS.

BY FRANK J. SPRAGUE.

*Mr. President and Delegates:* Scarcely 15 years—a period of time yet within the memory of the youngest of us—have passed since the beginning of a new era, the transmission of energy for light, power and the reproduction of speech. Of the progress of the first I need not speak, for the delegates of this Convention are better cognizant than I of its history and the advance it has made within that time. The spread of the telephone to nearly every town and hamlet in the fourteen years since it was exhibited as a scientific toy at Philadelphia, and the financial success of the parent company are facts continually before your minds or ringing in your ears. But that great industry, the transmission of electricity for power, with its possibilities of all kinds, is of very recent development. Six years ago there was scarcely a hundred electric motors in operation in the United States for any purpose whatever. To-day there are no less than 15,000 motors in use, applied to not less than 200 different industries, and an industrial revolution is taking place equalling, if not surpassing, in importance that attending the introduction of the steam engine, and marvelous in the rapidity of its growth.

It is not my purpose to dwell at length upon the subject of the transmission of power by electricity in its general application, but to touch upon one branch only, that of railway work, reviewing briefly the development in the United States, pointing out the salient features of successful operation, noting what has been already accomplished, and after some remarks upon the legal questions which have arisen, considering the possibilities of the future.

The modern electric railway may be said to have been born in Europe; its babyhood was in Europe; but in its youth and younger manhood it is purely American. In 1851, Dr. Siemens of Berlin established the pioneer railway on the Lichtenfelde line in the suburbs of Berlin, and I believe it is still running. It was followed by other roads, some commercial and others for exhibition, erected by the firm of Siemens, and by work done by other electrical engineers. The Siemens also established a line at Frankfurt. The Drs. Hopkinson established one at Port Rush, Ireland. Another was established at Blackpool. This last was a conduit system. A double metallic overhead system was established in 1888 at Vevey, Switzerland, and comparatively recently the Siemens Bros have established a conduit system at Buda-Pesth.

The first line which was established in the United States for actual commercial service was a suburban line of two miles in length built by Mr. Daft just outside of Baltimore, in the latter part of 1885, using a surface central rail. Other lines were established by Mr. Vanderpoel in various parts of the country, using the single and double travelling trolley systems, with the trolley travelling upon and carried by the wire and connected to the car by a flexible cable.

In all this pioneer work the system used was that of direct supply, but most of the mechanical features as well as the electrical details have now given way to other and more efficient methods of operation.

Of the more recent work three classes demand attention, one being the system of independent units operated by the storage battery, and the other two being direct systems of supply, one underground, the other overhead. I shall not enter into details of these three systems or their modifications, for it would be a repetition of much which has already been written, but I will briefly state the facts and the conclusion I have formed concerning them.

There is something exceedingly attractive in the proposed application of storage batteries to the propulsion of cars. To be able to conveniently store up a large amount of energy in a box, put it aboard of a car, carry it around with us, and take from it a greater or less amount of work, offers, when practicable, a solution of the street car problem for which we are all devoutly hopeful. But let us look at it from a commercial standpoint. The storage battery is still a long way from being a serious competitor of the direct source of supply. True, great improvements have been made in it, but these improvements have not very much altered its character, or the weight which is necessary, or the care which must be exercised in getting an economical return from the battery. These improvements have made it possible to take a heavier charge from the battery without producing buckling, have made a rougher usage of the battery mechanically possible, and have in some instances greatly reduced its cost of manufacture, so that the element of maintenance is a less serious one than it was a year or two ago; but the capacity of the battery, while it has been somewhat increased, remains such that it is still necessary to have about 3,500 pounds to propel an ordinary street car. This weight seems excessive. It takes up space and is a serious extra weight to be carried around. It requires frequent shifting and its capacity as well as discharge rate are so limited that it is simply impossible to work such a battery upon grades which are at all severe. I believe it is possible with care to operate a storage battery on grades not exceeding say 4 per cent and with limited speed and daily mileage at an expense about equal to that of horses, or possibly a little less; but still at almost double the expense which is necessary upon a suitably erected and properly run overhead system.

Nowhere in the United States, that I am aware of, is



these serious storage battery work being done at the present moment. The nearest attempt was where recent experiments were made on the Madison avenue line, New York City, where about a dozen cars were run up until 8 o'clock in the evening, but owing to legal complication only two cars are now running there—with what daily mileage I do not know. But nowhere is the work done at all equivalent to what is constantly practiced and demanded on the overhead line. On that service, motor cars start out at 5 or 6 o'clock in the evening and run until midnight. Many cars make 150 or 160 miles a day; and some cars have even made 180 and 190 miles a day. Half of this for storage battery works good duty, but it is not up to the demands which street railway managers make, and until radical improvements are made in it, the field of application will be very limited.

The conduit system of direct supply has been attempted in several places, notably at Denver, Cleveland Alleghany City and Boston, but at all the places mentioned these experiments have proved disastrous and have been abandoned save the short section at Alleghany City. In England the Blackpool line under special conditions has been, I believe, fairly successful, and at Buda-Pesth the Messrs Siemens have a conduit system in successful operation. There, however, the drainage is very perfect, and in addition a man is detailed for given sections of the track, and is continually employed in patrolling his section and cleaning out the conduit. Assuming good sewerage, the conduit can unquestionably be made to work. It becomes then a question of cost; but for general application especially in view of the fact that most of our cities do not have a sewerage system which can take care of the street drainage, the expense is prohibitory save on large systems under exceptional conditions. I look forward to the time when many existing well constructed and well drained cable conduits will become electrical conduits, and electricity will then score another victory.

The system, however, which has made such a marked advance is the single trolley overhead system with universally flexible underneath contact, and this has been the growth of the past two and a half years. I think I can fairly claim for the Sprague company the pioneer place in this development but the commercial development on the lines it laid down has been with great energy pushed forward principally by both it and the Thomson-Houston companies. The first work done by the Sprague company, other than experimental work on the elevated railroad, was made but a short distance from this city. A single car was started on the Union Passenger Railway company's line in St. Joseph, with a small  $7\frac{1}{2}$  horse power motor, single geared, and adapted to run at a very high speed was applied on a suburban extension in 1887. It is a matter of interest that that line has seen nearly every change made in the system. Its lines have been extended twice, and it has both the old style motors and the more modern equipments which are now in vogue. But all the work done in St. Joseph in 1887 was, it may be said purely experimental; and it was not until the 2d of February, 1888, that the Richmond road was officially opened to the public. I speak of this road not so much because of my personal interest in it, but because it marked an era in the development of electric railways. A radical departure was made from the work which had been done prior to that time, not only in the amount and extent of the system equipped and the number of the machines operated, but also in the disposition and control of the machines, the system of overhead wiring and the method of getting the current from the wire. The characteristics of that line are now pretty well known. It was a road of about twelve miles in length, with 30 curves, some of them of exceedingly short radii, with grades running as high as 10 per cent., and with a roadbed utterly unfit for the traffic which it had to support. The equipment was for 40 cars, requiring 80 machines, and was to be operated from one central station. When first proposed the attempt was looked upon with a good deal of ridicule, not only by street railway men but by electricians themselves. The street railway men thought that the ordinary conditions of street car service would make it impossible for a self-propelled car to ascend a grade exceeding 5 or 6 per cent.; and as for attempting a 10 per cent., that was outside of the bounds of reason. As regards the electrical problems, the motors, instead of being placed on the car body and flexibly connected by chain gearing or belts to the axles, were placed underneath the car and flexibly and concentrically geared to the axles. They were uncovered and exposed to the mud and moisture, and to all the loose obstructions which might accumulate in the street. They were built to run on a 400 volt grounded circuit and to run in either direction with fixed brushes. Insanity was a mild term to designate the mental condition of those who made these proposals. The motor man was confined to his ordinary platform, and the regulating devices there situated. A wire of only one-fifth of an inch in diameter was extended over the track, and supplied at intervals of its length by a wire carried alongside the street where the strain upon the poles was least, and this main conductor was supplied, as in the Edison system, at three or four central points by feeders which came from the central station. The current, moreover, was taken from this wire, not by a traveling carriage upon the wire itself, flexibly connected with the car, reaching upward and pressing underneath the wire. This contact arm, which is now technically known as the trolley pole, was placed in the centre of the car and had a universal movement, resisting up and down movement sufficiently to make a good contact with the wire, but at the same time follow all vertical deflections. In addition, it had a lateral movement of considerable reach offering little opposition to any side deflection by the wire itself.

Well, Richmond has passed into history. It has had its vicissitudes—it has had its victory as well. But it remains with all its crudities and with all the accidents which have marked its career, as the one great step in advance whose feature, in the main, have been followed in almost all the recent electrical railways. Machines have been made larger,

they have been made mechanically and electrically more perfect. Changes of detail have been frequent; but most of the characteristic features there outlined, mark to-day nearly every electrical railway which is in operation, in process of construction, or under contract.

Taking our work of 1887 as a basis, in 1888 it was trebled. The work of 1888 was quintupled in 1889. As to what it will be in 1890 I will not hazard a guess. Its strongest opponents two years ago are to-day its best friends. The enterprise which two years ago was in an experimental stage, for which it was difficult to get a dollar or procure an investment, to-day demands the best thought and the most active energies of two great corporations and a number of smaller ones. The contracts for electrical equipments involve larger amounts than almost any other widely extended electrical enterprise. The business done in this year will probably be not less than \$6,000,000. Every street railway in the United States is watching with eager eyes the developments of the rival electrical interests. The advocates of the cable system are on the defensive. The advocates of the electric systems are reliant and aggressive. Its flexibility, the ease with which it is extended, its adaptability to various conditions of service, its freedom from any long continued break-down, the marvelous advances which have been made in perfecting its apparatus, all insure its supremacy.

As illustrative of the remarkable progress of electric railways, I may state that there are about 130 towns in the United States with one or more electric railways in operation, construction, or under contract, and that these roads comprise about 1500 miles of track, equipped with about 1700 motor cars, requiring 3000 motors of an aggregate capacity of 45 000 H.P., and steam and electrical generators of 25,000 H.P., and that the cars in operation are making about 100 000 miles per day, and within three months the mileage will be doubled.

We still hear occasional discordant cries about the possibility of break downs, or the cost of operation, or the danger of the current, or the unsightliness of overhead wires.

This latter question is one of rather æsthetic than practical, for as now erected, the railway lines are among the most costly, and with care, can, in view of the service rendered, be made very unobtrusive.

As regards danger, the electric car is the safest possible vehicle because of the remarkable facility of control, and as to the objections to the overhead line on the score of danger which have been raised sometimes by the municipal authorities, and which have been cited by the telephone interests, they are, we may safely say, imaginary rather than real. Some two years and a half ago I settled upon 400 volts as a fairly satisfactory standard of potential for which the motor for street railway service should be built, allowing about ten per cent. drop in the distribution on the line, making the potential at the station about 440 to 450 volts. In some cases, where dealing with heavy work on extended lines, and small conductors, we have raised the potential at the motors to about 450 volts, making no change whatever in the machine, and have run the central station at 480 to 500 volts. There are, in the United States, about eighty electric railways in operation. Almost every employe of the contracting companies, and a great many employes of the railway companies themselves, including not only the line men, and those whose business it is to work upon the electrical equipment but also the conductors and drivers have received shocks from these lines of greater or less duration, and under almost every possible condition. Yet, in no instance which ever came under my observation, or of which we have any reliable record, has serious injury resulted from the shock of the current itself. When we consider that these shocks have occurred to persons of all ages and of all physical conditions, and for varying periods, the experience seems to be quite ample to warrant the assertion that as ordinarily constructed a constant potential circuit of 500 volts is not dangerous to human life, and we can dismiss that question.

Reviewing the work of the past two years, that which was promised for electricity has been, in the main, entirely fulfilled. It has proved itself capable of doing the most extraordinary work under the most unfavorable conditions. Grades of  $12\frac{1}{2}$  per cent, and more recently of 14 per cent, have been ascended with loaded cars. Grades three miles long, varying from 4 to 8 per cent, have been ascended by a motor car pulling a tow-car. It has done this work where it would have been impossible to have done it by horses. It has enabled the running speed of cars to be increased even in crowded cities 50 per cent; and on suburban routes speeds of twenty miles or more have been made. Experimental runs of twenty miles an hour on the ordinary street car with the narrow flange wheel have been attained; and on special experiments, a speed of nearly 150 miles an hour has been attained for a short distance. The electric car has shown that it can run faster on both up and down grades, that it can be gotten under way and stopped more quickly than a horse car; that with any given number of cars the mileage has been increased, and the same time intervals made with a less number of cars. Many cars have made from 180 to 190 miles in one day. Horse space having been saved, the equipments occupy a third less space, and this fact, coupled with the ability to back when necessary and again quickly gain headway, has enabled an electric railway car in crowded and narrow streets, to work its passage where a horse-car would be at a dead standstill. Not only has the possibility of running down grade faster been established, but that possibility with a high degree of safety, because in the event of losing control of a car by the brakes, the instant reversal of the motor has brought the car to a standstill. This has frequently been the experience on electric railways, and in one case which was recently reported to us, the inspector stated that a car was going nearly thirty five miles an hour on the down grade before the driver attempted to reverse his machine; but when he did reverse it, he brought his car to a standstill with the loss of only one gear. Making due allowance for the possible excitement of the inspector, I think the car was unquestionably moving at least twenty-five miles an hour when the reversal took place.

The riding of an electric car is unquestionably easier than on the majority of cable or horse cars, starting and stopping more easily and being in a very large measure free from oscillation. It is scarcely necessary to say that the cars are cleaner, that they are brilliantly lighted, and that it would be possible even to heat them by electricity. The sanitary conditions are entirely altered, and the health and comfort of the people conserved by doing away with stables with all their unsavory characteristics and injury to the value of adjacent real estate. Branch lines of every possible combination of grade, curve and ill conditioned street, which has so often proved prohibitory to any other system of propulsion, have been operated by the electric system. Distances up to six miles or more away from a single station have been operated without difficulty, and large numbers of cars from one station. It can very properly be said that there have been many break-downs; that machines have depreciated; that there have been exasperating troubles. True, these things have happened; and in cases of defective workmanship and careless inspection or management, they will happen, no matter what system of propulsion is adopted. The accidents which can happen to a motor come within a very limited category, and the liability of a motor to these accidents is being very rapidly reduced to a minimum, till it is becoming to-day the most perfect place of machinery, capable of the longest continued use and of a large amount of abuse. The very accidents which have happened, as simple as the causes are, and I may say here that nine-tenths of electrical troubles are due to mechanical defects, and the very make-shifts which have been temporarily resorted to to overcome the troubles and keep the lines in operation are the best evidence of the flexibility of the system and the perfection to which it will arrive. No other machine in existence has, in so short a period of development, been brought to such a degree of perfection, is capable of such varied application and can be so easily and quickly understood.

The cost of operation has proved entirely satisfactory, and my early claim has been substantiated. In a paper read before the American Institute of Electrical Engineers in August 1888, and also in some earlier communications, I made an estimate as to the expense of operating a 30 car road, dividing the operating expenses under two heads: (1) those belonging to central stations; and (2) what may be called road-operating expenses; the sum of the two constituting the total cost of motive power. In making this estimate I used extreme care, and while preserving its accuracy, made every reasonable allowance that I thought necessary. The conclusion at which I arrived in that estimate under the conditions there given, was that the total cost of motive power per car mile should not exceed four and three-tenths; and this included everything except executive and salary expenses, taxes and insurance, and matters not connected with motive power. I also stated that this was less than 40 per cent of the cost of operating by horses for the same number of cars and under the same conditions. My estimate was then considered altogether too liberal in favor of electricity. Without going into details, I may state that the most reliable possible records of roads under every possible condition of service, bear out the claims that I then made as to the economical operation by electricity. I have the records of only a portion of the roads which we have equipped. Some roads see fit to make public these records. Others, and with a good show of reason, do not care to do so, because of the feeling that municipal bodies, in considering the granting of franchises, will not look at the increased investment, but, ignoring the manifold advantages to be gained by the introduction of electricity, for the public, as well as for the company, are inclined to make unreasonable demands in the way of reduction of fares, or require unnecessary and unprofitable extensions of lines, forgetting that the reduction of one-cent in a fare means a cut of 20 per cent in the receipts of the company, and that a very remarkable saving of expense must be made in order to meet this reduction of revenue, especially where there is an increased equipment on which interest must be earned. But suffice it to say that careful investigation will convince any candid mind that the economic claim has been entirely supported, and the best evidence of it is the rapid adoption of this method of propulsion.

A few remarks may be in place relating to the interferences with other established interests which this new application of electricity has developed. Such conflicts, as electricity is applied to different industries, necessarily arise and result from the claims made by two or more enterprises to the same area of occupancy whether of air or earth. There have been, long before electric railways became at all common, conflicts of a more or less limited nature between the electric lighting and telephone interests. In the early days of electric lighting and more particularly in that branch known as constant potential distribution, an attempt was made to use the earth for one-half of the circuit, precisely as was done, and has been done for years, in telegraphy. Practical experience, however, demonstrated that this was a mistake where incandescent lights were concerned and it is manifestly a mistake where arc lights and high potentials are used. The objections on the constant potential incandescent circuit were pertinent because of the liability of fire in the buildings where the ground circuit was used. And the element of personal danger very quickly put an end to any attempt to use a ground circuit for an arc light system. The same cautionary reasons applicable to these two classes of industries do not, however, apply to overhead electric railway systems. The electric railway circuit is purely an external circuit. Its derivations are through the cars which it supplies. It is led into no dwelling; its fixtures are not within the ordinary reach of any being. It is carried in the open air, in full view, in the most direct possible lines, and with only such supports as are necessary to make its construction safe, and to keep it in alignment. The whole construction of an overhead electrical system is materially simplified and, in my opinion, made, mechanically as well as electrically, far safer by the adoption of a single wire,

(Continued on page 42.)



# The Street Railway Gazette.

S. L. K. MONROE, - - - - - MANAGER.  
E. V. CAVELL, - - - - - EDITOR.  
EDWARD J. LAWLESS, - - - - - ASSOCIATE EDITOR.  
W. L. S. BAYLEY, - - - - - MECHANICAL EXPERT.

## GENERAL OFFICES:

### CHICAGO:

8 LAKESIDE BUILDING.

AGENCIES } San Francisco, - - - - - 1222 Bush Street.  
} Toronto (Canada), - - - - - 53 Magill Street.  
Cable Address=TRAM, CHICAGO.

Annual Subscription (Including Postage).	Per Copy
United States, Canada	\$2.00. . . . . 25c.
Great Britain, Ireland, India, Australia	10s. . . . . 1s.
Germany	9mk. 75 pf. . . . . 89pf.
France, Belgium, Switzerland	21fr. 95c. . . . . Fr 1.10.
Spain	21ps. 95c. . . . . Ps 1.10.
Austria, Holland	6fl. 74c. . . . . 55c.
Italy	12 lire. . . . . 1½ lira.
Venezuela	12 boliv. . . . . 1½ bol.
Mexico	\$3.00. . . . . 30c.

Annual Subscriptions in Argentine Republic, 2½ peso; Brazil, milreis; Turkey, 54 plasters.

[Entered at the Chicago post-office as second-class matter.]

\*\*\*

Matter for publication should reach the Chicago Office not later than the last day of each month. All communications should be addressed, THE STREET RAILWAY GAZETTE, Chicago, Ill.

## N. E. L. A.

The Kansas City convention of the National Electric Light Association has now passed into history, and if the delegates failed to return to their respective homes with new food for thought and fresh material to work with, it was simply because they paid but little attention to the proceedings.

Taking the papers as a whole, which were presented for the deliberation of the Association, we do not hesitate to express the opinion that they were fully equal in pith and point to any that were read at former conventions of the N. E. L. A. Organized, as is the National Electric Light Association, not only for the purpose of affording its members an opportunity to derive benefit from a semi annual exchange of ideas and experiences in the lighting field, but also for devising ways and means for the economical distribution of power, it is but natural that it should turn its attention to the great problem of the profitable and commercially successful utilization of electricity as a motive power for the purpose of street car propulsion. Two papers pertaining to this subject were prepared by able men and presented for the consideration of the convention; one on the "Standardizing of Potentials for Street Railway Systems," in which it was announced that the Thomson-Houston and the Sprague companies had agreed to use a standard potential of 500 volts upon all lines operated on their respective systems, when those lines do not necessitate the use of special apparatus to insure successful operation; and the other paper, by Mr. Sprague, on "Electricity as Applied to Street Railways." The first named paper is of especial interest to central station men, and scarcely less so to managers of electric street railways.

Mr. Sprague's admirable handling of his subject showed him to be most thoroughly conversant with the wide and far-reaching possibilities of electricity for the purpose of general propulsion, while the ground he took with regard to the senseless litigation between the telephone and electric light and power companies received the hearty endorsement of the convention.

A full stenographic report of both of these papers appears in this issue, and can not fail to be read with deep interest by those directly or indirectly interested in the present application or the future possibilities of electricity in the field of motive power.

## Electric Railways as Investments.

As our readers are well aware, the GAZETTE has devoted considerable attention to the scientific aspects of electric railroading. New types and styles of motors have been treated thoroughly in its columns, and all improvements which have been made in electric street railway science have received due recognition at its hands.

In the investigation into the *technical* or mechanical aspect of electrical street railroading, the *commercial* side has been, in a measure, overlooked, although this is the one which more particularly concerns street railway managers. An electric railway, no matter how scientifically or how carefully constructed and equipped, will not be used unless it promises to give adequate returns for the capital invested. Under these circumstances, it is interesting and gratifying to note that almost all of the electric railways now in operation have been successes from a commercial standpoint, and that the records show that capital invested in similar enterprises is almost sure to be remunerative when ordinary care and judgment is taken in its investment.

The report of the East Reading Electric Railway company, for the past year, emphasizes the fact that electric railways are a commercial success, and that even during the first year of their operation they show gratifying financial results.

This road was installed a little more than a year ago, using the Sprague system and, although the location of the road is not a particularly advantageous one, yet the results have been most gratifying. Treasurer's report made on January 1st, 1890, shows that dividends at the rate of 8 per cent. per annum upon the working capital were paid, besides leaving a goodly balance in the treasury.

Another interesting fact in connection with this report, is that it shows that during the last year the number of passengers carried was more than double the entire population of Reading, a convincing and eloquent testimonial to the popularity of the electric railway. The operating expenses during the year were \$4,380.81, or about 2.6 cents per passenger carried.

While the economic advantages of the use of electricity are not so pronounced on such a small road as upon a line operating a greater number of cars (4), these results are very gratifying to those interested in electric traction, and can not but result in establishing the confidence of investors in electric railway securities.

## Telephones vs. Electric Railways.

A decision in favor of the telephone company has been handed down by Judge Taft in the suit of the Cincinnati Telephone company against the Mt. Auburn Inclined Plane Street Railway company. This decision is exactly contrary to that rendered in similar suits at Harrisburgh, Pa, Eau Claire, Wis., Salt Lake City and other cities.

We understand that this decision is not final, and that the case will probably be appealed by the street railway company.

As we go to press we learn that Mr. J. L. Barclay, of the Sprague Electric Equipment Co., who has been East for several weeks, has secured the contract for the electrical equipment of 200 cars for Col. Lowry's system.

(Continued from page 41)

using the rails as a return circuit. The practical proof of the wisdom of this decision is the fact that about 95 per cent of all the electric railways either in operation, construction or under contract, in the United States, use only the single wire underneath contact. It scarcely seems necessary at this stage to go into the defense of this system. Its simplicity, the lightness of construction, the symmetry of outline, the size and strength of the poles, the fewness of the supports, the simplicity of all curve work, turnouts, cross-ings and sidings, and especially of all switchwork and switch operations, are so manifest that elaboration of these features is unnecessary.

The use of the grounded circuit has unquestionably interfered with another and widespread application of the use of electricity, and that is the operation of telephones which likewise use the grounded circuit. So long as electric railways were in an experimental stage, running perhaps in suburban districts, out of the way of telephone circuits, little or no attention was paid by telephone companies to their existence. The marvelous strides which have been made in the past two years and a half, bringing the railway system into the very heart of towns and cities and into the forefront as a commercial enterprise, the rapid increase in the extent and use of the telephone system, have brought the two interests in direct conflict, which conflict is solely because of their common use of that great reservoir of electricity, if we choose so to term it, or rather that great common medium for conducting it, which has been used alike by railways, telephones and telegraphs since these industries were started.

The claim of the telephone company in brief is, that by right of prior occupation and because of their vested interests, no electric railway or other circuit shall so use the earth if interfering with their lines in any way. Their claim is far reaching; it is of the broadest possible character, and, strictly interpreted, is an exclusive claim on the use of the earth for transmitting energy by electricity. That there is an interference with the telephone circuits by an electric railway circuit is undeniable, and the interference is one which is annoying. The character of the interference is two-fold. Part of the trouble arises from induction, that sympathetic response in the telephone circuit to any changes in the electrical condition of the railway circuit, and part to leakage caused by the diverting through the telephone system of a part of the current which has been discharged into the earth and is on its way back to the central station.

The relative amount of these two interferences has been variously stated. On the part of the telephone company it is admitted that conduction or leakage is a source of trouble. They also admit that the use of any metallic return circuit, it matters not what, whether it be an individual circuit for each telephone, or a common metallic return for all the telephones, will obviate this or most of it. Even this much is admitted by the telephone interests with a great deal of hesitation, despite its perfectly apparent truth. But they go further. They claim that this is not the principal cause of trouble, but that most of it is due to induction, and that if a return metallic circuit overhead were put up by the railway company—that is, if a double trolley system were used—then the telephone troubles would all cease. The various attempts they have made in the courts have been with a view to either compelling the railway companies to cease operations or to so change and erect their entire system as to abolish the use of the single trolley and erect in its place the double trolley system, or, on the other hand, to compel the electric railway company to pay for the necessary changes required in the telephone circuit to avoid the interference. No sooner was this issue presented than it was promptly met by the railway interest which I represent.

Now, what are the facts? First, as I have stated, there is, unquestionably, an interference between the electric railway and the telephone services; but, of the character of this interference, it seems to me that no intelligent man, who honestly makes an investigation, seeking after truth, and truth only, and not biased by the commercial interests which have retained him, can have any reasonable doubt. The assertions made by the telephone interests leave little room for exaggeration on their part. Not only has the character of the interference been misrepresented, but the costs of any changes made necessary on the part of the telephone company to avoid trouble, or on the part of the railway company to change over its system, have been grossly misstated.

As a matter of fact, the trouble from induction is of the very slightest character, and that must be patent to any one who is familiar with this particular electrical action. Generally, the trolley wire is situated in the middle of the street, anywhere from twenty to thirty or forty feet away from the telephone lines. It rarely runs parallel to them, except for a comparatively short distance, possibly two, or even three, miles, but more often less. The current used upon this wire is not of that character which distinguishes some of the arc light circuits, but is of more or less even flow, and the abrupt and large charges due to change of load on the motor are comparatively infrequent. There is a very small change due to the variation of resistance of the armature of the motor, because of the different relative positions of the commutator blocks under the brushes, and there is, likewise, a variation due to the slight but rapid changes of counter electro-motive force set up by the motor when running. But, although these changes can be detected inductively, provided the conditions are favorable, for instance, if both the telephone and railway circuit were wound around a common bar of iron, the character of the disturbance is not so serious as to preclude conversation. But the trouble which does really become pronounced is that which is due to the actual differences of potential which exist on different parts of the track circuit, in other words, at the terminals of the grounded telephone circuit. There is discharged into the earth, as I have stated, a slightly varying current. It may be at some point considerably removed from the station, and in close proximity to the ground terminal of a telephone whose exchange is likewise



grounded at another point much nearer, electrically, to the station. The current reaching the rail has to travel back to the station, partly by the rails and partly by the earth. Both offer more or less resistance, and there is an actual difference of potential between the point of discharge and the station, rising at times to as much as twenty or thirty volts; but it is, of course, a variable potential and the current which flows over that path is one which varies in its character. Having discharged the current in the earth, there is absolutely no limit to its diffusion. We desire, of course, that it should return by the rails, but no boundary whatever can be placed upon it. A part of it goes through the rails, but some portions will go through the earth, through the water ways, through mineral veins, through gas and water connections, through electric light tubes, through telephone circuits, through rivers and canals, and, in fact, over any and all paths which offer it opportunity to return to the source from which it originated. The shortest geographical line between two points may be a thousand feet. The path of the current between those two points may be anything from a thousand feet to fifty thousand or more. But, precisely as the rail current is thus disseminated or diffused in its return paths, so also is the telephone current. True, it is only a current of small capacity, so small as to interfere with no other enterprise or translating device except others of like character, but its diffusion is of precisely the same character, and over the same territory, and through the same channels of conductors as that of the rail current. Could the telephone current be limited in its path, and the claim of the telephone company be narrowed down to a specific section of earth, then, possibly, there might be some basis for its claim to the use of that section; but such a restriction is, of course, manifestly impossible. Hence, any claim the telephone interest makes to the earth must be vague; it must be all reaching; it must be exclusive. It would seem that it has no more legal right to make a claim which prohibits a railway in the town, in which the telephone circuits are operated from using the earth, than it has to make a claim that a railway in any other city with which the telephone may be remotely connected shall be prohibited likewise from using the earth in that particular city, although it may be a hundred miles away. It is a well known fact among electricians, and, probably no better known than among the telephone people themselves, that, perfectly independent of railway enterprises, a far better service can be rendered the patrons of the telephone where a complete metallic circuit is used and the use of the earth abolished. The telephone is the most jealous detector possible of all disturbances of electrical condition on the circuit which includes it. Its every function as a transmitter of speech depends upon this marvelous delicacy. As now operated in the majority of telephone exchanges it is subjected to continual interference, not only from the railway circuit, but from every electric light, power or telegraph which is brought into proximity with it. It is subject to interferences from atmospheric changes and discharges. The telephone circuits themselves interfere with each other. Cross talk and false signaling are common. Almost all these troubles can be avoided, and the telephone service made far more perfect, by using either the individual metallic return, with the switch board properly constructed for it, or the individual return, the return wires coming to a common terminus, which would make absolutely no change in the telephonic switch board; or, what has become known as the McClure device, or the use of an artificial metallic ground or common metallic return, that is, by breaking the ground connections of the individual telephone and connecting them all to one common copper return of a resistance which shall be low compared with the resistance of the instruments themselves. The lower the resistance of this common return the less any interference of the telephones with each other. The cost of this latter method is a bagatelle. It should be put up by the telephone companies for the sake of their patrons, perfectly independent of whatever other electrical enterprise they may be brought in contact with. Wherever intelligently put up, the relief from outside interference has been almost absolute, and the testimony of parties who made complaint when telephone companies first sought to obtain an injunction against the rail ways, will many of them now make the strongest affidavits testifying to the relief which has been obtained by this change in the method of running the telephone circuits. It is unquestionable that the telephone company is waging the warfare from the standpoint of economy, pleading the rights of vested interests notwithstanding every telephone expert knows the great advantage to be gained from a metallic circuit, and notwithstanding the fact that sundry papers read at telephone conventions not only admit that the metallic circuit is best, but give testimony from the exchange superintendents that wherever their patrons once used the metallic circuit and long distance telephone they are never satisfied thereafter to use the grounded circuit. It is likewise suggestive that the Bell Telephone company to-day advertises no less than about one hundred and fifty local stations in New York City equipped with the long distance telephone and the metallic circuit. Since there is not an electric railway in the city of New York their improvement in this direction could not have been dictated by interference from that interest.

The position, from a legal standpoint, seems to be something as follows: As between telephone and electric light and power companies, there may be a question concerning respective rights, because the electric light and telephone companies may both occupy the highway as of equal dignity. But even in such a case, neither one of the interests can have just right to an injunction, because the proper way of redress is a suit at law to determine the amount of damages for which the one party is liable on account of a violation of the other's rights, permanent injunction being granted, I believe, only where the troubles are irremediable, or where the damages can not be readily computed. Wherever the telephone company, however, seeks to trammel electric railways in their free use of the public highways, and especially where they have been

granted the right of such use, an entirely different question is presented. The public highway was originally and primarily dedicated to public travel whether by foot, horse, or by vehicle, and for no other purpose. It was contended some years ago that street railways ought not to be allowed upon highways because they had tracks; but wherever courts have been called upon to make a decision, it has been held that street railways were but an improvement upon the older methods of travel. It was even at one time questioned whether there might not be a distinction between the rights of a street railway where the public owned the fee, and those in which the title was in private individuals, but even this distinction was not allowed. When electric railways were developed, an attempt was made to claim that they were a perversion of the highway; but it was then held that electric railways were an improvement only upon street railways propelled by horses or other motive power, and should occupy the highways with the same rights as were enjoyed by the street railways using the other motive power before electric railway propulsion was resorted to.

Since both the telephone and the railway companies occupy public streets by public license, it is of course necessary to examine into the source of their respective titles, and the character of their occupancy, because otherwise it would be impossible to understand what are their respective rights. The electric railway has proven a great advance upon any method of street car propulsion hitherto known. It has been shown to be economical, safe and advantageous as a method of public travel. It certainly can not be said to be objectionable *per se*. It interferes less with the travelers upon the highway than many other methods of propulsion, and its very extended use shows that it has been sanctioned by public authorities as a safe and proper method of travel; and the single trolley system being used by nine tenths of the street railways in the United States using electric motive power, as against all other methods, certainly shows that practical experience is in favor of that particular method. As an improvement upon the method of propulsion, it would seem that an electric street railway upon a public highway, occupies the same and enjoys the right of travel thereon as of equal dignity with any or all other persons or vehicles upon that road, and that this right of enjoyment is within the original purpose for which the highways were opened. On the other hand, it is pertinent to inquire what right or title a telephone company has in the street, whatever? By virtue of the original dedication of the highway, they have no rights except that of toleration. Telephones and telegraphs are identical in contemplation of law, and have always been held to be an additional burden upon highways. In almost every case where this question has come up in the matter of telegraphs, such has been the decision. The statutes under which telephone or telegraph lines are permitted to be erected, provide that while they may be so erected, the poles and wires shall not interfere with public travel upon the highways. Since this is true, the telephone companies are not upon a public road by virtue of right, but of toleration; not as the equals of the street railway, but subordinate to it. They occupy a secondary position and this being the case, where conflict arises between the two it would seem that the telephone company must eventually yield, because its claim against any competitive enterprise is nothing less than a claim to the exclusive right of the earth, not to some section of it, because there are no limits to which the telephone wires may not reach, no boundaries to the portions of the earth which form a part of their circuits. Certainly no statute ever gave an exclusive privilege to a telegraph or telephone company; and any claim for such an exclusive right, to be substantiated, must show an express or implied grant from some source, and the boundary as well as the source of that title. Not only this, but it must show that the title is exclusive. In view of the fact that the telegraph companies had used ground circuits for thirty years or more before the telephone was discovered, and that patents were refused for such use, it will be somewhat difficult for the telephone company to show the source of its exclusive claim and title, and it is manifestly impossible to show the limits of the territory from which any other enterprise must be excluded so that it will in no way interfere with the operation of the telephone system; for the telephone circuits being attached to gas and water systems of the community in which it is located, the ramifications of such systems and of all the subterranean electric conductors of the earth in contact with these metallic conductors are unknown to science. How other electric currents entering the earth may do so without evading the charmed area of the telephone, and disturbing its grounded wires, no man can say, much less can the telephone people themselves. The boundaries, then, of their claim being so vague it would seem that their claim itself must necessarily fail.

Within the past two years there have been, I believe, eight attempts made by the telephone interest to get an injunction. The first was in Akron, Ohio, in the latter part of 1883, where the Central Union Telephone company of Chicago, attempted to restrain one of the Sprague roads by injunction. This was denied. The next suit was against the Harrisburg road and the Sprague company by the Penn Telephone company. A number of common stockholders, I believe, were interested in both companies, and, although the attorneys of the railway companies were fully prepared and desirous of seeing the case brought to trial, the suit was abandoned and compromised for the very sensible reason that it would cost less on both sides to compromise than to carry the case to the higher courts. The next attempt on the part of the telephone interests was in the application for an injunction against one of our roads at Chattanooga, Tennessee. This injunction was likewise denied. Then came a conflict in Salt Lake City, where many of the people were so interested that they said as between the telephone and electric railway interests, if the decision was against the railway company, they would abolish the use of the telephone. Such heroic measures apparently were not necessary, for the injunction was twice

denied. Then application for an injunction was made in Cincinnati, and this will probably become a cause célèbre, for an injunction, on what ground I do not yet know, was granted, and the case will probably be carried to the higher courts.

In Eau Claire, Wisconsin, an attack was made on the railway interest under cover of the state law which the telephone companies had quietly gotten passed requiring a return insulated conductor for any circuit carrying electric energy. The injunction was here denied, for the telephone company had somewhat overstepped itself and found itself quite as much in the mud as the railway company might be in the mire so far as the law was concerned, because they were themselves the carriers of electric energy and were using grounded circuits and consequently had no standing before the court. The last case with which we have been directly concerned is one at St. Joseph, which has not yet been tried.

In Albany, where another electric railway company is operating, the telephone interest has succeeded in getting a temporary injunction. I believe this case in which my own company is not particularly interested, except sympathetically, has been recently reheard and a decision on the merits is now pending.

With the records thus given, it would seem that the electric railway companies have little to fear eventually from the attacks made upon them by the Bell Telephone company. They are well within their right and that being so their position must sooner or later be established beyond all peradventure. The cases which I have enumerated are not the only cases in which there have been interferences between the electric railway and the telephone; but in almost all others both the railway and telephone companies have recognized each others moral, if not legal, rights. Often the same stockholders have been in both companies and a sensible compromise had been effected, in which telephone company has sometimes changed the route of its circuits, or put up a common return, or they have used each other's poles, and a just division of expense has been settled upon. This would seem to me to be the better plan wherever conflicting interests arise, and is one which I would recommend in all cases where the telephone companies are willing to recognize the justice of the legal position of the railway company instead of attempting, as they have in the cases mentioned, to deny that right. A just compromise, but no surrender, should be the motto of the railway company.

So much for street car practice, and looking forward we naturally ask what will be the future of the application of this remarkable agent? Already we have gone from one car units to trains of 2, 3 and even 4 cars in the street, and 40 cars have been operated from a single station. The next step will be the operation of some of the cable roads, then systems like the underground railway of London, the elevated railways of New York, the Brooklyn bridge system, and then suburban lines will be operated. But is this the limit?

I have been frequently asked, whether in my opinion, electricity will ever be used on trunk lines for through passenger or freight traffic? My answer is, probably not, according to present notion of trunk line transportation, and not by present methods of train despatching. But in these qualifications I admit my hope and expectation of rapid through transit under certain conditions. Let us for a moment consider a few facts.

Railway managers are constantly meeting with a demand for more rapid and luxurious methods of transit; and every effort which executive ability and financial expenditure within reason can devise, is made to meet this demand—but how? I think I can safely say that as steam railways are operated, a maximum speed of 90 miles per hour, and a running speed of 60 to 70, is all that can be hoped for in steam railway travel under the best conditions which can be provided. The limitations are too many. The maximum speed made by a locomotive to day is but little more than that made 20 years ago. True, engines are larger and more powerful, but the increased weight of trains has made this necessary. To get pulling power there is a limit to the size of the drivers, and whatever their size, there is a limit to the economical rate of piston speed and to the number of reciprocations per minute. As the size of the driver increases the centre of gravity of the engine is raised. As the steam demands become greater, the difficulty of taking water and of firing is more pronounced. Even now it requires the best work of a fireman when his engine is pulling a heavy load to prevent the engine "dying" on the road, or at least falling far short of its duty. The increase of running speed has been obtained principally by cutting down grades, straightening curves, filling up ravines, replacing wooden structures by permanent way of iron or stone, the use of heavier rails, safer switches, improved methods of signaling, the interlocking switch and signal system, gates at all road crossings, the abolishing of grade crossings; in short, by improvements in detail and management, which permit a higher safe speed over a more extended section of road because of the greater intrinsic safety, and of the greater degree of confidence inspired in engine driver, rather than by marked advance in the speed capacity, which should not be confounded with the power capacity of the engine itself.

With respect to electric motors the question is not now can a motor of sufficient capacity be built, or efficiently and positively controlled, but rather how can the electricity be produced and supplied to the motor and at what potential can we work. We all hope to see the time when electricity can be produced economically from coal without the intervention of steam engines or dynamos; and it may be that something akin to the present steam practice of locomotive will then be common; but I think that even then it will be quite likely that a central station method of distribution will be the more advantageous. On the other hand there are those who hope to see the storage battery so reduced in weight and improved in other particulars as to warrant its use in a large way in locomotives. For myself, I prefer to consider the possibilities of another method,



the amplification and development to its full capacity of present street railway practice, and for that purpose I will briefly consider a supposititious case, namely an express between New York, or rather Jersey City, and Philadelphia. But before considering this problem let me point out a feature or two about steam roads. When first laid through a new country they usually consist of a single track, which must do the manifold duty of providing for through and local freight, and local and express passenger traffic in both directions, with what success, those who are called upon to travel in a new country are well acquainted. The route of such a road is determined mainly with the idea of getting from and place to another by a more or less direct route, but especially by one which shall not require too costly construction. Once determined, new towns spring up along the line of the road, and old towns grow until the demands of traffic make a double track necessary, and as civilization grows apace, the freight traffic demands a track by itself, and four tracks now constitute the equipment. So, following the development of the road, we will find that in time the express and local passenger trains will require individual tracks and a six track road will be a necessity. But it must be borne in mind that the express is not intended to cater to local travel, and its route is subordinated, both in the matter of curves, grades and crossings to the requirements of the early travel. The highest demands of such a service would require that independently of the local travel, a through express track should be constructed by the most direct route possible between the principal localities, and every effort made to reduce the curvature and grades as much as possible. No matter how much it costs to build such a road, when the traffic is sufficiently large, it will pay to do it.

Suppose such a road to be an electrical one, and the method of supply to be from one or more central stations, the current being taken by a universally flexible underneath contact, from a rod carried above the car, and the return circuit made by means of the rails. This method, using of course a wire instead of a rod, having been almost universally adopted wherever street cars are propelled by electricity, its characteristics are well known. What the structure of the road bed would be need not here concern us. We might use the standard T rail and road bed, avoiding as much as possible curves, grades and grade crossings, and the overhead rod can be used simply for supplying the current; or some form of a double or single track road slightly raised above the ordinary level, and with the upper rod forming a steadying and centering chord as well as a current supplier may be used. These are mechanical questions with which we need not concern ourselves at present. What does concern us, however, as electrical engineers, whether the cost of copper, the potential required, the losses on the line and the number of stations are such as would be prohibitory.

As regards the potential other things being satisfactory, whatever pressure is demanded in the interest of economical and defective service will be used, and means will be found, consisting mainly in care of construction, which will make its use for the purposes, and as intended safe and proper. We have in these matters to face the same questions that we have in the matter of steam pressure, or of railway speed. To accomplish the larger engineering feats necessary to meet the demands of carrying and commerce, we will be governed more by belief in our power to fully subordinate a good servant to our will than by our fears of its vagaries when allowed to become a master.

From 8 a. m. to 9 p. m., a period of thirteen hours, 21 regular trains leave the Jersey City station of the Pennsylvania road to run through to Philadelphia. Twelve of these make but one or two stops. The balance make more or less stops according to the running schedule. In addition to these there are a number of local trains serving way stations. Taking the through trains only and allowing an average of say five cars to a train, there are in the thirteen hours about 105 through cars despatched from Jersey City, at the rate of one single car every seven and one-half minutes, and of the through trains not making over one or two stops there would be one every thirteen minutes. We will suppose an additional express track has been built, leaving the distance about what it is now, say 90 miles, but that the grades had been eased and the worst curves rectified. For the practical purposes of this paper I will consider that the road is level and that the cars are to be despatched in two car units on a perfect block system, and to be run through to Philadelphia, with not more than one stop, at fixed intervals, and at a high average rate of speed, say 60 miles per hour. In the systems that I would propose the main one that I experimented with some years ago, slight grades would make little difference in the general result, especially if the grade percentage, if expressed in a whole number, did not exceed the quotient of the traction in pounds per ton divided by 20; because when  $C = \frac{t}{20}$

where  $t =$  traction in pounds per net ton and  $c =$  grade percentage expressed as a whole number, the work of traction and of lifting are equal. For example, suppose  $t = 10$  pounds and grade of  $c =$  one-half per cent, and that we had on a double track one car coming down the grade and one other ascending it, both at the same speed. Then gravity would be supplying just enough power to propel the car on the down grade at a fixed speed, and enough over to supply the lifting and traction work of the other car would have to be applied, which would be just the amount required to propel both cars on a dead level.

Suppose the grade to exceed the ratio expressed above, then the car on the down grade would have an excess of lifting energy, and this would have to be used in accelerating the speed of the car, or used up on the brakes, or it could be used by a process of reconversion for the purpose of supplying at short range, part of the extra energy required by the ascending train. Just how this can be done pretty fairly understood by electricians, but I will touch on it again, because it is a feature of vital importance in determining the matter of motor control in a large system

such as we are now considering, and because it illustrates one of the most beautiful features of this method of converting energy. No matter whether a machine be used for a motor or a dynamo, whether to convert mechanical energy into electricity, or the reverse, the armature develops an electric pressure, or potential, which is dependent upon its speed and the affective strength of the magnetic field in which it is moving. If this field is in shunt relation to the armature and in connection with the track circuit, we have by any of the well known methods a means for independently varying the strength of that field. When such a machine is geared to a car, it can either drive the car, acting as a motor, or be driven by it as a dynamo, and in connection with any other similarly connected motor, or the central station generators, will form an electrically couple, either of them may be driven by, or drive, the apparatus to which it is connected. If the couple thus made is between the motor and the central station dynamo, we have at one end a machine driven by a constant speed engine, and generating an approximately constant electro-motive force, and at the other end a machine of greatly varying speed and with facility for increasing or diminishing the electro-motive force which it generates. The result is an electrical differential which will establish a current between the two in one direction or the other, according as the pressure developed by the motor is lower or greater than that developed at the generating station. If the pressures are equal no current whatever will pass. If the couple consists of two motors thus connected, then we have two apparatuses each of which is generating a variable electro-motive force, and there may be a current between these or not according to their relative electrical pressure. A large system is tied together in the most intimate possible manner. The tracks are cross connected, the overhead conductors would be cross-connected, and we would have in effect, what would correspond to two large planes, between which was moving at varying speeds a number of independent units, these two planes being kept at a constant potential by means of the generating station. All motors starting, running on a level, or ascending a grade, would be requiring current. All motors running on a down grade with just that velocity which the force of gravity would give them, would require no current; and motors running on down grades of greater percentage than is required to give them power for traction, or motors slowing down, could be generating currents which are sent back upon the line to aid in the general supply. No other system of distribution can by any possibility have this very remarkable interchange of energy. When running at a particular speed the slightest touch or movement of a regulating handle would make the motor receive from or give to the line, current in any desired quantity. The braking power of a motor thus acting as a generator is very powerful and the most perfect imaginable, because unlike the ordinary method, the brake does not operate if the wheels stand still, the very essential of the braking operation requiring the wheels to turn. And it is a well known fact that the most effective brake work is when the wheels do not skid upon the track but when they are turning under the pressure of the brake; and contrary to the ordinary braking practice, the energy of the electric train, instead of being thrown away in the form of heat and using up our wheels and brakeshoes can be made useful in the propulsion of other trains on the same track. I have tried this method of braking with such a degree of refinement that a heavily loaded car would creep on a down grade at a pace so slow that an egg could be put under the wheels and cracked and removed before the wheel would pass over it.

Having thus touched upon the characteristics such as I would propose for a railway system of this character, let us resume the consideration of our proposed line between New York and Philadelphia, and try to form some idea of the electrical pressure which would be required, the service which could be demanded, the number of cars which could be handled, the speeds which could be maintained, and the number of stations which would be required to operate the system. We will assume for the purposes of this investigation an overhead conductor in the form of a solid rod one inch in diameter was used over each track, or, if you please, a smaller rod over each track, and a main conductor making up the equivalent capacity proposed, and a track of equivalent capacity. I take this arbitrary size because it is convenient for the purposes of our calculations, and because it falls well within the limit of expenditure which such a system would warrant. For instance, the American Bell Telephone company has a line of long distance telephone wires running from New York to Boston, a distance of about three hundred miles, over three times the distance which we are considering. On these poles are about seventy wires each, of No. 12 copper. The aggregate area of these conductors is over 800,000 circular miles, and the total weight of copper on this line, which is used simply for telephonic purposes, would be about forty per cent more than the weight of two copper rods an inch in diameter running from New York to Philadelphia. If the investment is a reasonable one in the telephone system, can not we certainly consider it a reasonable one in that larger field of the transmission of power of which we are now speaking?

As I have stated, of the number of trains which in thirteen hours leave Jersey City for Philadelphia, twelve make usually only one or two stops. Allowing sixty cars, this would be about one car every thirteen minutes. Possibly this interval of thirteen minutes is nearly as short as would be desirable between cars running at an average speed of a mile a minute, no matter how perfect the block system; and it would be necessary, possibly, to run these cars in double car units. We will assume, for our purposes, the size of a car such as is used on the elevated road, or the Brooklyn Bridge in New York, which would, with motor and passengers, weigh from twenty to twenty-five tons, or a total of, say, fifty tons for our unit. The formula to determine the size of conductor for a single transmission of car is

$$c m = \frac{15666 n l}{e v \varphi}$$

where  $n =$  the number of horse power,  $l =$  the distance in feet,  $e$  the potential at the motor,  $v$  the fall in potential and  $\varphi$  the commercial efficiency of the motor. If we assume the station situated in the middle of a line, that is, at the best point, and the work divided equally at the middle section on each side, then  $l$  being the length of line, we have the formula

$$c m = \frac{15666 n l}{4 e v \varphi}$$

This will be practically the same if the work is distributed over the entire line.

If more than one station is used, then the formula will become

$$c m = \frac{15666 n l}{4 e v \varphi s^2}$$

that is, the size of the conductor would vary inversely as the square of the number of stations, if properly distributed. Now  $v$  may be expressed as a fraction of  $e$ , and for practical purposes, we will let  $v = \frac{1}{3}$  of  $e$ , and  $\varphi$  be such that

$$\frac{15666}{\varphi} = 16800$$

that is,  $\varphi =$  about 93%. Then we have

$$c m = \frac{37800 n l}{e^2 s^2}$$

which may be expressed thus, that the size of the wire varies inversely as the square of the product of the number of stations and the electro-motive force.

We may also note that with any fixed size of conductor the electro-motive force and the number of stations vary inversely, a somewhat important fact to remember.

We have another formula, one for the power required by a moving car, which is

$$h p = \frac{4}{75} w m \left( c + \frac{t}{20} \right)$$

where  $w =$  the weight in net tons,  $m$  the miles per hour,  $c$  the per centage of grade expressed as a whole number, and  $t$  the traction in pounds per net ton.

As I have stated, we will assume in this formula that  $c$  equals zero, a consideration in which I am justified in express service on a road of the character I have outlined, with the relation of grades and traction given out with the method of braking I have described. Our formula would then become, using ten pounds per ton as our average traction,

$$h p = \frac{2}{75} w m$$

which, substituted for  $n$  in the distribution formula, gives us

$$c m = \frac{1008 w m l}{e^2 s^2}$$

or, substituting for  $l$   $5250 d$ ,  $d$  being the number of miles between stations

$$c m = \frac{5322240 w m l}{e^2 s^2}$$

We have assumed for our conductors two rods an inch in diameter, and that the rail has the same resistance. Hence, substituting for  $c m$  its value, 2,000,000, we have

$$e = \frac{2.66112 w m d}{s^2}$$

$$\text{or, } e = \frac{1.631}{s} \sqrt{w m d}$$

It will be noted that  $m$ ,  $w$  and  $d$ , that is, number of miles per hour, weight handled, and distance over which operated, are all affected in the same way. Hence, with any value of  $e$  and  $s$  we can vary the relative values of  $w$ ,  $m$  and  $d$ , so long as we do not disturb the product. That is, we can halve the number of miles and double the speed, or double the distance and halve the running speed, keeping the weight hauled the same, and so on. For  $w$ , the total weight, we can substitute the weight of each unit,  $c$ , and the number of units,  $b$ , thus making the formula

$$e = \frac{1.631}{s} \sqrt{m b c d}$$

For the line proposed,  $d = 90$ , we have

$$e = \frac{15.56}{s} \sqrt{m b c}$$

Taking our unit of two cars, at fifty tons, the time intervals between them as ten minutes, and at sixty miles per hour as our mean speed, we have on the whole system eighteen active units of two cars each.

$$m b c = 54000,$$

which, substituted in our formula, gives

$$e = \frac{3616}{s}$$

which means that, with one station in the middle, the potential at the motor farthest from the station would be 3616 volts, and near the station one-ninth higher. Can we handle it? Yes, in time, I think we can; but perhaps not yet. Nor is there any necessity for doing so: for if we increase the number of stations and go to a three-wire instead of a two-wire system, making the track the balance circuit, we would have motor potential, or expressed by the following table:

Number.	STATIONS,		MOTOR POTENTIAL.	
	Miles apart.	2 wire.	3 wire.	
1	---	3616	1808	
2	45	1808	904	
3	30	1205	603	
4	22½	904	452	



which last brings us down to ordinary street car practice, which is only the beginning of what will be done in the effective handling of potentials.

So, after all, it does not seem such a serious electrical problem, and certainly not one to shrink from.

We can, in another way, illustrate the influence of the position and number of stations, and the potential used. Suppose we had a station at Jersey City to supply the entire line at a certain potential over a conductor of the required size. If the station is moved to the center, the weight of copper is only one-quarter. Use two stations properly spaced and the weight is quartered again. Double the potential, and the weight is further quartered. Now use the three-wire system, and the weight is again quartered. So that by these very simple processes the original weight has been reduced to  $\frac{1}{16}$  of the original.

I do not think I need to point out further the value of a proper determination of electrical values in a problem of this character.

We see, then, that the suppositious case is well within the range of possibilities. A sixty mile express service every ten minutes instead of a forty to forty-five-mile service every hour would revolutionize travel. Of the comforts of such a mode of travel I need not speak. That it will, in the not very distant future, be a fact, I know you all agree with me in hoping for it.

#### DISCUSSION :

MR. ARMSTRONG of Camden, N. J.: I want personally to thank Mr. Sprague for one of the most interesting papers to which I ever listened. The figures that he has given us, the explanations that he has made and the statements throughout his address, have been to me of the most intense interest. I was pleased with the legal position he took. As a lawyer I must commend him as a very good lawyer. Some of the matters he has stated were novel to me in the statement of them, but he stated such general principles, that I had to say I knew it all the time, but didn't think of it.

MR. SPRAGUE: As to the statement of the investigation we have made particularly into the motor power which has been used in central stations, the amount of power used, of course depends upon the amount of traffic, the number of cars run, the schedule, the intervals between the cars, the grades. In fact, there are a great many questions which determine it. But we have very recently had an investigation made on five roads embracing every possible condition, and in a short time those will be published in detail, and the result which will be interesting to you as central station operators, in the amount of operating power, the maximum per car, the minimum of current used. All these figures will be very exact and they will be useful in determining the contracts which are sometimes entered into between electric railways companies and electric lighting associations.

The cost of the operation of railways, is very much less than we have claimed. Whenever we have asked the railway companies to give us this cost of operating their roads, they reply: "Well, when we were in the early stages of this business and it was necessary to bring us to a satisfactory condition of mind to sign a contract, it was different. We find there are a great many elements of economy now we have reached there, and we would be glad if you would keep that element of economy out of sight, and do not publish it broadcast because we do not want some legislative body to come down on us and say, 'Reduce your fares to four cents or sell seven or eight tickets for twenty cents.'" So we have had, commercially speaking, to accede to that request.

There will be gradually in many of our cities an amalgamation in the electric light and railway interests. It seems to me that is the natural outcome, and I know that oftentimes the same stockholders are interested in both the electric light and railway companies. I am going to have very soon, in a little town in South Carolina, what I think is the most complete electrical station in the United States. Some associates and myself, being convinced that not only the electric light but the electric railway business was a good thing, from the experience we have had with it in the past two years, got hold of an electric lighting company that was earning a very reasonable dividend on its cost. The company had an electric railway franchise which was exclusive for thirty years, and which had been granted both by municipal and legislative action. It also had the general railroad privileges of condemning public and private property. The rights being exclusive not only in the two towns, but for the vicinity, for thirty years, and there being

no railroad there, and there being established an electric light interest there, and there being no gas company, we thought the opportunity was an excellent one to carry out that idea which is always in the minds of electrical people, namely, the consolidating of electrical interests. We not only consolidate the electric part of it, but we consolidate the elements of management and personnel. We have different systems, the arc light system, the incandescent system, the power circuit and the railway circuit, all in the same building and under the same roof of the car sheds, and with all respect to the telephone interest, I think pretty soon we will have the telephone circuit. We are going to run telephone wires on the same poles with the others. We are going to demonstrate that it is quite possible to run a telephone circuit, an electric railway pole line not only in conjunction with it, but in conjunction with electric lights and incandescent lamps. We hope this enterprise will be profitable and that there may be a great many other places in which the same thing can be done.

PROFESSOR EATON of Liberty college: I would like to ask Mr. Sprague if he has any objection to stating what his principal reasons are for his conclusion that the storage battery system will not successfully compete with the overhead or direct wire system?

MR. SPRAGUE: It is this, the simple reason is that you can not three times convert energy, at the same economy that you can once. That is the first reason. Secondly, because you can not carry a dead load of two tons around, unnecessarily, without energy—you can not carry it around anyway, necessarily or otherwise, without energy. You must carry your storage battery and you can not get rid of that useless load. It weighs nearly two tons. It weighs as much as thirty-five or forty passengers. It weighs more than your motor equipment; it weighs more than your car body considered by itself; it weighs more than your iron trucks considered by themselves. We have to carry our motors around, we have to carry the trucks, the passengers and the car bodies; but to carry our storage battery is another thing. There are no storage batteries in existence furthermore whose storage capacity will permit of more than 26 or 30 horse power being taken out of it. If you limit the weight or size of your battery, you reduce its capacity. On grades of eight per cent, and that is about the maximum which the adhesion of the rail will permit, you will find a great difficulty; you will use about 30-horse power of mechanical energy, and the motor must develop that. There is no storage battery that you can put on a 16-foot grade to day, out of which you can take that power for thirty minutes at a time; the capacity is not there. But when you get the overhead line or the underground conductor, provided it is connected with a big engine and a lot of dynamos at the other end, you can demand from that station all your motor can carry. There is no storage battery which a company dare recommend for operation upon a 6 per cent grade, or that you could run 160, 170 or 180 miles a day. The maximum work of a storage battery per car, per day, is about 80 or possibly 90 miles, and there are a very few cars doing that. There are no storage battery cars in the United States that I am aware of, that are working 18, 19 or 20 hours a day, as is the case with the direct system of supply.

I hope, as cordially as any other man can, that the storage battery is going to be a success, but there is no question that its limitations are pretty clearly fixed and that it can never compete with direct sources of supply in capacity. There is no limit to the capacity of the motor or the amount of current you can use from a direct source of supply. There is certainly a well defined narrow limit in the case of the storage battery. I say that with all friendliness to the storage battery, because I am interested financially in one—or rather I should say one is financially interested in me.

#### REPORT OF THE EXECUTIVE COMMITTEE.

Gerald W. Hart then read the report of the executive committee as follows:

The executive committee has confined its work largely to the present convention; other matters connected with the association having been dele-

gated largely to special committees. The following committees have made reports at this convention, and the reports have been accepted and spread upon the minutes: Committee on underground conduits and conductors, E. T. Lynch, jr., chairman; committee on harmonizing electric light and insurance interests, P. H. Alexander, chairman; committee to confer with Mayor Grant in regard to the International Exposition of 1892, Dr Otto A. Moses, chairman; committee on electrical data, A. R. Foote, chairman; committee to memorialize congress on the abolition of custom duty on copper, C. A. Brown, chairman; committee on standardization of potential on electrical street railways, E. T. Lynch, jr., chairman; the national committee on state and municipal legislation, A. R. Foote, chairman.

The work upon which these committees have been engaged is of great importance to the association, and the reports show that the subjects entrusted to them have been carefully considered, and a great amount of work has been accomplished. The secretary informs us that the number of communications from these committees which have gone out to the electrical public exceeds 12,000.

The following committees have not reported: Committee on patent legislation, Arthur Stenart, chairman; committee on electrical execution, E. W. Maher, chairman. Owing to the fact that the members of the executive committee are so widely separated, but one meeting has been held prior to the present session, since the Niagara Falls convention, although the members have been in constant communication.

At the above named meeting, held at New York on October 25, the date of the present convention was decided upon, and a general programme was outlined; also an important resolution upon the compulsory use of underground system for high potential circuits was passed.

The finance committee, a sub-committee of the executive committee, has audited and approved the accounts of the treasurer. A committee on credentials has been appointed for the purpose of examining the credentials of the active members.

The finances of the association have never been in better condition than at present, or the future more promising. The experiment of the past year of having the headquarters of the association at New York, has proved to be an entire success.

Since the last convention, there has been a net gain of 61 members; the total membership being now over three hundred. At a recent meeting the following names were unanimously recommended for honorary membership in the association, agreeable to the constitutional provisions therefor (see Art. 3, Sec. 4): Sir William Thompson, Prof. Henry A. Rowland, Chas. F. Bush, Thos. A. Edison, Prof. Elihu Thomson and Frank J. Sprague.

The report was then voted upon by a standing vote, and unanimously adopted.

The association, on motion, then adjourned until 3 o'clock p.m.

#### AFTERNOON SESSION.

PRESIDENT WEEKS: We are fortunate in having with us on this occasion one who has been for years intimately connected with Mr. Edison, one whose name has stood for the Edison interest throughout America; one whom I have, on urgent solicitation, succeeded in inducing to address you. I take great pleasure in introducing to you, Edward H. Johnson, of New York City.

MR. JOHNSON: President Weeks has sufficiently apologized for my appearance before you, to speak upon a matter, that comes in the nature of a surprise to me; and he has also explained why I am called upon to speak—concerning Mr. Edison's phonograph. Having been associated with Mr. Edison, in the laboratory and out of it, almost constantly now for the past twenty years, I am necessarily more or less familiar with everything that he has done. The phonograph, however, is an invention with which I am particularly familiar. Therefore it would seem appropriate that I should comply with the request of your chairman and say a few words to you on that subject. At first he only called upon me to explain the operation of the instrument, the principle upon which it acts, and to that I assented. Then he broadened out his request until finally he wishes me to go at some length into the history of the instrument and the whole subject. To do Mr. Edison justice and to do myself justice, I could not well do that. I have agreed, therefore, simply to relate the circumstances under which



the phonograph had its origin, to explain the instrument to you and then call upon the gentlemen who have the device in charge to operate it for your benefit.

When Professor Bell brought out the magneto telephone with which you are not only familiar, but which your children now know, Mr. Edison conceived the idea of amplifying the voice of the telephone, so to speak, by producing a transmitting apparatus which would generate a much stronger current than Mr. Bell's instrument did; and thus by operating upon Mr. Bell's instrument as a receiver, produce a much more audible and distinct vocalization, and render the instrument of much wider commercial value. These experiments ultimately led to the carbon telephone transmitter now universally used throughout the world and which you all recognize as the instrument to which you address yourselves when you are speaking in the telephone; and it was in the course of his experiments with that instrument that he conceived the idea of the phonograph. It did not dawn upon his mind, or for that matter upon the mind of any of us associated with him at the time, just what he had done, that is, produced a talking machine. He remarked to me one evening when he was pressing his finger lightly against the diaphragm of a telephonic instrument, and feeling those vibrations, "Johnson, if I was to put a needle in the center of that diaphragm and make a point there, an indenting point like the point on the old time Morse telegraph register," with which you are no doubt all familiar, "then draw a slip of paper or other easily impressed substance underneath that needle, the vibrations of that diaphragm would be accurately recorded on that paper." Being an old telegraph operator myself, I immediately saw the force of that apparently not very sane remark, and I said, "Certainly it will, but what of that?" Well, he said, "If we take that paper and start fresh with it, and draw it under the point of that needle or diaphragm, put a slight tension on the needle and pull the needle, it will follow the ins and outs of these indentations that naturally would be in the diaphragm, precisely as it did move when it made the original indentations." I said, "That is true; but what of that?" "Well, only this, that would be a telephone repeater. Of course if I speak in the telephone and that produces a vibration on the receiving telephone's diaphragm, that receiving instrument is made to record these indentations on that piece of paper, and that paper is afterward drawn under that needle, that diaphragm re-vibrated, without the action of the human voice, I have only to make that second diaphragm another transmitter, and I will carry my message on again to another station. Thus, instead of telephoning within the limit of the capacity of a single instrument, I will telephone to these limits, and then automatically repeat the speech over another circuit to the limits of the second circuit. In other words, you will make a telephone repeater that will be the exact counter part of the telegraphic repeater so well known in general use." I said, "It looks feasible; it looks practicable." That was the end of it for the time being. Neither one of us or Mr. Batcheller or the other laboratory associates of Mr. Edison thought any more about it for a long time. I was in somewhat straightened circumstances at the time, as we all were, owing to the fact that we had spent some six years in developing a system of electric automatic telegraphy, which we sold to our friend Mr. Gould, who was several years paying for it, and has not yet settled up entirely. The situation was that we had to look around and see what we could do to earn our bread and butter. Mr. Edison has since found a way of earning his. I had to strike out in some new direction; and it occurred to me it would be a very good idea to go around to the leading water places, this being summer time, and exhibit Edison's telephone and apparatus, particularly the musical telephone; describe it to the public, who seemed to be very much interested in these acoustic experiments of Mr. Edison and Mr. Bell at that time, and make a little money that way. I did it by having my singers stationed in the Western Union Telegraph building in New York, having my receiving apparatus in a house like this at Saratoga, Buffalo or Rochester, four or five hundred miles distant from New York, and reproducing the voices of these singers to my audiences at these distant points. It was very successful. A great interest was being aroused in the subject just at that time. In the course of one of my lectures or improvised talks, it occurred to me it would be a good idea to tell my audience at Buffalo about Edison's telephone repeater, which I did. My audience seemed to have a much clearer appreciation of the value of the invention than we had ourselves. They gave me such a cheer as I have seldom heard. I did not comprehend the importance of the device at the time; but the next morning the Buffalo papers announced in glaring headlines, "A Great Discovery: A Talking Machine by Professor Edison. Mr. Edison's Wonderful Instrument will Produce Articulate Speech with all the Perfection of the Human Voice." I realized for the first time that Edison had, as a matter of fact, invented a talking machine. The immediate importance to me was that this created a sensation, and I had very large audiences in all my entertainments thereafter. Realizing that and having had sufficient experience by this time to profit by such things, I made a special point of this feature in my next entertainment, which was at Rochester, and I had a crowded house; one that did my heart good—and my pocket too. There was a most magnificent enthusiasm. That satisfied me that I had better go home and assist in preparing this instrument. I knew from my own experience in the matter that it was a comparatively simple thing to do, so I canceled thirteen engagements ahead and went back home with these newspaper clippings. I went straight down to the laboratory, which was then at Newark, and I said, "Mr. Edison, look here. See the trouble you have got me into." He read these things over, and said: "That is so; they are right. That is what it is—a talking machine." I says: "Can you make it?" He says: "Of course. Have you got any money?" I says: "Yes, I have a little." And I had—a little. He says: "Go to New York and get me three feet of stub

steel an inch and a half in diameter, and get me a piece of brass pipe four inches in diameter and six or eight inches long, and bring it down here, and we will make it." I took the next train to New York and got the material, took it back and went to work. Within twenty-four hours we had a little revolving cylinder, turned with a crank, and a simple diaphragm needle, which I will explain presently, wrapped a sheet of tin-foil around the cylinder, and gave it the original phonographic sentence, "Mary had a Little Lamb." Then we set it back, to see what the instrument was going to do about it. It came out to our entire satisfaction. Not as clear as it does to day, but it was "Mary had a Little Lamb," sure enough. That was the original phonograph, and the starting point of an invention, which, notwithstanding all that Mr. Edison has done since, notwithstanding my high appreciation of what he has accomplished, notwithstanding the commercial value, the vastly greater relative commercial value, of his subsequent inventions, is to my mind the greatest thing he ever did, and which, as a matter of fact, is the invention which has carried Mr. Edison's fame and name outside of the comparatively limited technical circle in which he was then known, throughout the civilized world, and makes to day the simple announcement that somebody, it makes no difference who he may be, known or unknown, is going to make a few remarks about Edison, quite sufficient to crowd the largest auditorium with the most intelligent members of any community, in this country or abroad. And I speak from experience when I make that statement.

Now, a few words in explanation of this instrument, and then you shall hear it. In the first place, there is a mistaken idea as to the character of this instrument. It is popularly supposed to be an electrical instrument, because it is the invention of the greatest of all electrical inventors. It is not an electrical instrument at all. It is a mere bit of mechanism. It is a mechanical arrangement, pure and simple. It is necessary to have a revolution of the cylinder and to get that mechanical motion you must have some motive power. As I explained, the original machine was turned by hand. Others have been turned by water motors, gas motors. This instrument on the platform is operated by an electric motor. That is a matter which has no significance in relation to the machine; it is merely the motive power to turn the instrument, and is no part of it. The instrument is simply mechanical. Its principle is this: When I speak I throw the air into vibration of a given form. That strikes upon the ear and produces on the auditory nerves certain sounds, or rather they convey to the brain certain sounds, that is, what we term sounds. Those sounds are infinite in variety, but they have an intelligent meaning to the brain, that meaning being simply a matter of education. It follows, therefore, that if I can produce those vibrations on the air by other means than my own voice, but precisely and identically those vibrations, I will produce upon the ear and consequently upon the brain, precisely the same sensations, and they can not mean anything else in the one instance than in the other. Therefore, this invention is nothing more or less than an instrument which will accurately receive and record those vibrations, and retain their character, form and number with absolute precision, and then mechanically do the work by operating something which will contribute again to the air, all those peculiar waves of the vocal chords of precisely the character and form of the vibrations that it originally received. If it can be done, you will, of course, at once perceive that the instrument, although a bit of mechanism, if it has the capacity to reproduce those vibrations, it necessarily has the capacity to produce upon the brain precisely the same sound that the vocal chords produced in the first instance. Therefore, what we want is an instrument that will do that. Now let us see how we make an instrument of that kind. You take anything, no matter what, a piece of paper like this (indicating) and utter a sound, the musical note "do" for instance, and in touching it with your finger on the opposite side you feel the vibration. Very well, we will call that a diaphragm, a paper diaphragm. We will put that in a suitable frame, and hold it in such a position as we want. Then we will attach to the centre of that diaphragm, because the center is the point of the greatest amplitude and the greatest vibration necessarily, a needle, not a sharp pointed needle, but a needle whose point is comparatively sharp, one that will not scratch, but will simply produce the indentations upon that yielding substance. Take and arrange that in such a way that this diaphragm that has this needle point against the surface of the revolving cylinder. Now, we will put around that revolving cylinder that substance—paper is a little too hard for the needle to indent, of course; but tin foil, which is much better, and it was therefore used for a long while, so we will say tin foil for the time being—we will put around that cylinder a sheet of tin foil, and we will adjust this instrument so this needle will press slightly against that tin foil. Now, we will revolve the cylinder with a screw attachment at the end, so that the cylinder shall go past, transversely, in front of this needle, very gradually, so as to present a constantly new surface of tin foil to the needle. Now, you speak against that diaphragm and cause a vibration of this needle, while that tin foil is passing in front of it, and you will necessarily produce on that tin foil indentations of precisely the same number, and of a depth corresponding to the amplitude of vibration of the diaphragm, precisely the same as the diaphragm yields, and that will yield precisely the same vibrations as the air yields that has been put in motion by the voice. Consequently you have an absolute record on the tin foil of the vibrations of the air affected by the vocal chord, not only in number, but of the same character in all other particulars. Now, if you will reverse the action of this cylinder, turn it backward, if you please, then drag the needle back again onto these indentations just where they began, and do nothing but simply rotate that cylinder, so as to cause the needle to traverse the ground over again, thus going in and out of all the little indentations, you get precisely the same effect upon the diaphragm as you had originally, because it now being

moved by the rough path, so to speak, which it previously created, it must necessarily follow the same ups and downs. So that you get the diaphragm in motion again as it was before with the net result that the diaphragm contributes to the air precisely the same movement that the air had sent out from the diaphragm. Consequently, you get perfectly articulated speech. That is all there is to the instrument. This instrument lay dormant for about twelve years. Mr. Edison went from his telephonic experiment immediately into his electric light experiments, and consequently gave no attention to the phonograph, always saying to those of us who would urge him to take the matter up: "When I get through with this I will take that up. That shall be the next thing." But the electric light came along, and before he got through the carbon transmitter he took that up, and the phonograph was ignored. Then he promised to take it up when the electric light matter was settled. Before he had satisfied himself with his work in that direction others took up the phonograph and worked on it to a considerable purpose, namely, Me srs. Taintor and Bell, Professor Bell of telephone fame. He and his associates took the matter up and endeavored to make a phonograph which was then merely a scientific novelty. In other words, to do for Edison's phonograph what Edison had done for Bell's telephone, make it a commercial as well as a scientific success. They succeeded in developing what has proven to be the correct principle, namely: that instead of making indentations in this plastic substance wax, which is now the thing used, they made a little cutting knife, and actually cut the material out with each vibration, thus effecting two things, a more decided record than was made by the indentation method.

The result of that was an instrument which while it did not speak and was not intended to speak in the original voice, as the old tin foil phonograph did, yet it spoke with such distinctness that if you placed the tubes to your ear, while the voice was low, it was wonderfully clear and the utterance was easily comprehended. They brought out on the basis of that improvement what is now universally known as the graphophone, which is simply the phonograph turned the other way around. They did not claim to have anticipated Mr. Edison in this great discovery. They simply claimed to have perfected Mr. Edison's instrument and thus brought it into the realm of commercial utility; but they did not make the progress that they expected, and Mr. Edison then took the subject up again, and the result of his efforts in that direction was the perfected phonograph. Consequently we now have the graphophone and the phonograph.

A very shrewd gentleman in New York, recognizing the great possibilities of this thing, went to work to acquire the ownership of both. Consequently the North American Phonograph company to day is the owner of all the rights of the graphophone and the phonograph, and there now being but one common instrument, the aim in this instrument is to give you all that is known of the last and best development of this wonderful apparatus which is to record what we say, keep it for any length of time, and then reproduce it for any purpose we may wish with as perfect a retention of the character and quality of the original voice as the telephone to-day in its best form. I want to say that this instrument, although it is fitted up here with a rather elaborate contrivance so that you may hear it, is designed expressly not to do that which we are going to call upon it now to do, namely, to talk loud. It is designed to address itself to the individual ear. That is because the instrument is intended for commercial use, and we do not want the message or letter which I have dictated in my study at home and sent to the office to have the type writer put it in writing, to be heard by everybody in the room. Consequently the instrument is designed to speak in a low, clear tone to the ear. We can make them speak as loud as we please, but at some loss of clearness of articulation. Inasmuch as it is impossible for everybody to assemble around the instrument closely, we will endeavor to make the instrument speak loud enough for you all to hear. In this connection I will say that Mr. Levy played in that instrument many years ago and frequently since, and invariably took pains to inform the audience that the phonograph was his only competitor on the cornet.

The phonograph was then brought into action, and after reproducing several cornet solos by Mr. Levy, it presented the following message from Mr. Edison:

"Edwin R. Weeks, Esq.,

"KANSAS CITY, MO.

"MY DEAR MR. WEEKS,—

"When I had the pleasure of meeting you at my laboratory in December last, you suggested that I should send to the Kansas City convention, which commences next week, a phonograph discussion upon the subject of my five wire system of distribution, which you were good enough to assure me would prove of interest to the delegates, and ever since that time I have been trying to find an opportunity to prepare the data.

"My failure to do so has been through no fault of yours, as your letters have constantly kept the matter before me, nor has it been through want of inclination on my part that I am obliged to substitute this explanation.

"Certain urgent matters of business which I was unable to anticipate have occupied my attention to such an extent that I have even had to neglect the important work of my experiments.

"While I could not have contributed to the success of the convention, which is already assured through its location in your enterprising city, I regret that I am unable to send something which would at least be more interesting than this apology.

"Yours very truly,

"THOS. A. EDISON."

After Mr. Edison's message had been uproariously acknowledged by the audience, the phonograph was persuaded to furnish a xylo-



phone solo with a piano accompaniment, which received an enthusiastic reception.

Closing the convention, Chairman Weeks said: "As we have finished our business, I now declare this convention adjourned."

Entertainment.

On the night of the arrival of the delegates an informal reception was tendered them by the Commercial Club of Kansas City, which was attended by a large number of the visitors. The meeting was thoroughly informal and delightful in every respect.

The Chicago, Milwaukee & St. Paul Railway Company, not to be outdone in hospitality, dispensed theirs in their usual princely way by placing a special train consisting of three coaches and a chair car for the ladies, at the disposal of the delegates to convey them to Excelsior Springs, at 3:30 p. m. of the 15th inst.

Upon arrival at the Springs the party took stages and hacks and gave the residents of the famous health resort a surprise party. On the way to "The Elms" a stop was made at the Empire Spring. Dinner was served at 6 o'clock, and the following menu was presented for the delectation of the hungry visitors:

MENU.

- Raw Oysters. Green Turtle, aux Quenelles. Celery. Consomme Celestine. Broiled Whitefish a la Point Shirely. Potatoes Gastronomes. Small Patties of Lobster. Radishes. Olives. Ox Tongue with Spinach. Sirloin of Beef. Wild Turkey with Dressing, Cranberry Sauce. Croquettes of Fowl, with Mushrooms. Sweetbreads Larded, Jardiniere. Champagne Punch. Mallard Duck, Currant Jelly. Mayonnaise of Chicken. Dressed Lettuce. Mashed and Boiled Potatoes. Baked Sweet Potatoes. Green Peas. Dandelions. Stewed Tomatoes. Sugar Corn. Plum Pudding, Cognac Sauce. Apple Pie. Lemon Meringue Pie. Strawberry Pie. Brandy Custard. Fruit Jelly. Assorted Cake. Fruit. Pineapple Bisque Ice Cream. Nuts. Figs. Raisins. Edam, Cream and Pineapple Cheese. Jersey Biscuits. Graham Wafers. Tea. Carbonated Waters. Coffee.

A mandolin band furnished delightful music during the banquet, at the conclusion of which President Weeks proposed the toast of "The cup that cheers but does not inebriate," referring, of course, to the waters. Mr. Holden responded to the toast stating that he felt something like a man who would seek to turn on the electric light without seeking first to generate the current; he bid the visitors a welcome to the Springs in the name of the Excelsior Springs Company and of the C. M. & St. P. Ry. Company.

At about 8 o'clock a number of the party, headed, of course, by Drum Major Randolph, took up a stand on the outside of the hotel, and made the welkin ring with the sound of old college and plantation songs.

On the way back to the city the same kind of order prevailed, Brother Randolph being made master of the ceremonies. The smoking car was the seat of war, and between Excelsior Springs and Kansas City every song that has ever been written (more or less) was sung by the inmates of the car, whose combined voices (the passengers in that car numbered about a hundred) completely deadened the rumble of the wheels. It was on this memorable trip that the indefatigable M. C. transformed the famous formula C = P/R into a convention yell (C. E. R.—rah, rah, rah).

The Electric Limited.

The special train chartered by the delegates to the convention in Kansas City was probably the most magnificent and the most perfectly appointed train that ever left the Pennsylvania R. R. depot at Jersey City.

The train left the second section of the Pennsylvania R. R.'s Limited Express to Chicago. Eight cars composed the train, which was vested from stem to stern. The train left the depot at precisely 10:30 a. m., Sunday, Feb-

ruary 9th, and reached Philadelphia at 12:15, thus making the run of ninety miles in 105 minutes. The first change of engines was made there; the second at Harrisburg, between which and Philadelphia—115 miles—no stop was made; the third change was made at Altoona. The passengers, in spite of the immense amount of entertainment going on within the cars, could not help feasting themselves on the magnificence of the scenery along the route, especially in the heart of the Alleghanies. The famous Horse Shoe curve, the Conemaugh and the Pack Saddle all came in for their full share of attention.

Pittsburg was reached at 10:30 p. m., where a stop was made, but only long enough to change engines and restock the larder. It was a very hungry crowd that thronged the magnificent dining car, the property of the Chicago, Burlington and Quincy Railway. The train proceeded on its flight to the west over the superb track of the Pittsburg, Fort Wayne and Chicago Railway, reaching the metropolis of the West about noon on Monday. A delegation headed by the ubiquitous and popular F. J. Degenhardt met them at the Union Depot, and after loading them into carriages proceeded to the rooms of the Chicago Electric Club. A still larger delegation headed by Mayor Cregier met them there and entertained them in royal style. A magnificent lunch was served, in which everything designed to gladden the heart of man figured, after which a number of the delegates drove around the city to "view the manners (minors) of the town."

At Chicago two additional cars containing the Western delegation were hitched on to the train, and at precisely five o'clock it left the Union Depot on its Western flight. It would hardly be just in order for us to have much recollection of the thousand and one amusing, entertaining and instructive incidents that occurred on a trip like this; let it suffice to say that the most cordial feeling in the world existed between the delegates; that there was a "McGinty" on the train (of course), and that the party was one of the merriest that ever left the Union Depot in Chicago. Neither can we pretend to remember the number of fools that were sold on the train before reaching Chicago, as to the time of arrival.

In conclusion it is only fair to give unlimited credit to Mr. Harry E. Heller, the general traveling passenger agent of the Chicago, Burlington and Quincy Railway, who had charge of the party, for his untiring good nature and efforts to make the Electric excursion a magnificent success, and in these efforts he was most decidedly successful.

Echoes of the Convention.

CLIPPED FROM THE DAILIES.

Not since the bankers' convention last summer has Kansas City seen so many diamonds as are brought here by the visiting electricians, and perhaps the biggest stone flashes on the finger of A. L. Ide, the president of the Ide Engine company, of Springfield, Ill. Mr. Ide is a well known electrician, and is a perfect gentleman.

Ed. H. Johnston and C. A. Benton, the Damon and Pythias of the Edison Electric Light company, are well known figures in the corridors of the Coates house. Mr. Johnston is now president of the Imperial Conduit company of New York. Both gentlemen are well known on the turf in the Empire state, and what they say about horses always goes.

There seems to be a strong tendency toward batchelorhood by the servants of science, but if a few matches do not result from the vision of so much Kansas City loveliness it will be because the gentlemen are thoroughly insulated. I. Ward Leonard, the handsomest and youngest general manager in the business, has come from his desk in New York with a very determined look in his eye.

James F. Kelly, general sales agent of the Edison machine works, is called by his associates the Apollo of Dey street. Though still a young man he has gray hair.

Mr. C. R. Field's physiognomy is a sufficient indication of his business capacity.

Mr. A. H. Patterson is not a tall man, but a fund of energy is concentrated in his person.

Mr. Hazeltine, one of St. Louis' good looking young representatives, spent several of his youthful years in China.

Mr. David E. Evans grows a bushy beard, and wears the appearance of one with whom the world has dealt bountifully.

Mr. T. Carpenter Smith is a giant in stature, and from his altitude looks down condescendingly on his smaller brethren.

Mr. D. J. Buckley wears a sandy mustache and an air of refinement. There is a spice of the dandy about his dapper figure.

His erect carriage, cropped mustache and commanding air suggest M. Alexander Kempt's vacation as warlike rather than scientific.

Mr. George M. Myers is still a young man, and if the push which his demeanor suggests goes for anything he has a prosperous career before him.

That Mr. T. H. Brady delights in fresh air and a healthful, vigorous life is apparent beyond doubt. His clear complexion and bright eyes speak it.

The city inspector of electric lights in Chicago, Mr. C. C. Haskins, is a genial white whiskered gentleman of some fifty or sixty winters. His face reflects some of the laughing light of that illuminating power which engages his everyday attention.

The following ladies accompanied the delegates to the electric light convention: Mesdames W. L. Cander, W. J. Johnston, George Cutter, A. J. DeCamp, S. S. Badger, E. L. Mason, Boston; M. G. Ford, New York; W. Wall, Chicago; W. R. Kimball, Montreal; C. O. Baker, Newark, N. J.; J. A. Seely, A. H. Patterson, C. E. Stump, E. H. Johnson, New York; F. T. Walton and Miss Walton, Philadelphia; J. A. J. Shultz, St. Louis.

STREET RAILWAY NEWS.

(See also "New Enterprises," "Extensions," "Elections," etc.)

(The following data is compiled with all possible care, but the publishers, receiving news as they do, from almost every state, territory and country, cannot be held responsible for errors, as it would be wholly impossible to obtain a verification of each item received by them in time for each issue.)

ALABAMA.

Birmingham—Col. L. S. Morton, chief engineer of construction of the New East Lake dummy line, says that the line will be built just as soon as the company gets the right of way.

Sheffield—The dummy line here, running from this point to Tuscumbia, has been leased to a party who propose to test its operation for a short time, and if the experiment proves successful will lease it for a number of years. We understand that the road and rolling stock are to be put in first-class condition, and probably extended.

CALIFORNIA.

San Diego—It is very likely that the San Diego street car lines will be operated by cable power in the near future.

San Francisco—The street committee of the board of supervisors has decided to grant a franchise to the California Cable Railway company to lay down and maintain a single or double track, commencing at the intersection of O'Farrell and Market streets, thence on O'Farrell to Jones, on Jones in a southerly line to Pine, thence on Pine to Hyde; likewise on California street in a westerly line on Kearney to Davis. The franchise will be subject to the payment of two per cent of the gross income of the new road to the city.

GEORGIA.

Marion—The first trip of the electric cars in this city was made on the 26th day of January, and the machinery, etc., worked to perfection.

Augusta—The Augusta Street Railway company has petitioned the council for permission to operate an electric line out to the Sand Hills. It will be remembered that a long time ago Mr. H. B. King secured the controlling interest in the stock of this road. Messrs. Fleming, Thomas & Co. are likewise interested with Mr. King. (A list of the officers and directors will be found under the head of "Elections," in the present issue.)

ILLINOIS.

Carterville—Mr. F. L. Bates, president of the street railway here, states that he has all the material on hand to proceed with the work of building the road.

Elgin—The Elgin Street Railway company has closed a contract with the Robinson & Moen Car company for twelve new cars, to be delivered before the first of May. The new line will commence operation with 18 cars—9 motors and 9 trailers.

Joliet—On the petition of the Chicago & Alton Railway company an injunction was issued by Judge Sibell against the electric railway company here on the grounds that the trolley wire was only 23 feet from the ground instead of 25 feet. This is the first railway company that has interfered with the electric railway project.

IOWA.

Oskaloosa—The contractors have filed a bond of \$5,000 to complete the 1 1/2 miles of street railway here by August next.

KENTUCKY.

Covington—The South Covington & Cincinnati Street Railway company will adopt the overhead system, permission having been granted by the council.

LOUISIANA.

New Orleans—The Crescent City Street Railway company has received permission from the council to change its motive power from animal to electric, and storage batteries will be used, the contract for the same having been made with the Electric Construction and Manufacturing company.

MAINE.

Peak's Island—Mr. Bennett is interested in an electric street railway scheme here. His headquarters are at the Valley View House, Peak's Island. The company has not yet been organized, but it is expected it will be at once, all the capital necessary for the building of the road having been secured.



## MASSACHUSETTS.

**Boston**—The West End Street Railway company has requested permission to build double tracks on Brattle street from Brattle square to Mount Auburn street, and to operate its cars through these lines by the over-head system.

A petition by Mr. Charles H. Nichols was recently presented to the senate, to be known as the People's Electric Railway company, to build and operate an electric road through certain streets. The petition was, however, tabled.

**Lawrence**—Mr. G. W. Mansfield recently made a survey of the proposed line of the Lawrence & Andover Street Railway company.

**Milford**—Since November negotiations have been pending between responsible Boston parties and leading business men here looking to the building of an electric street railway between this point and Hopedale to the granite quarries; also the Hopkinton line. A charter was granted two years ago and the Boston parties now, in consideration of the charter being passed over to them, agree to have the road running six months from date of agreement, about June next.

## MICHIGAN.

**Detroit**—We understand that the Detroit Motor company has put a car with its motor, etc., on the lines of the Detroit City Railway company.

**Grand Rapids**—The cable company has requested permission to take up some of its horse car tracks in several of the streets and to connect several of its branches together in such a manner that connection can be made with the cable line at Lewis street.

The Grand Rapids Street Railway company has notified the council of its acceptance of the franchise granted it, permitting it to change from horse to electric power.

## MISSOURI.

**Kansas City**—The People's Cable Railway company has received an extension of time in which to complete its line to the union depot. The road will be organized at once, Mr. Churchill succeeding Mr. Lish Hopkins as receiver. We understand that the office of general manager has been abandoned.

**St. Louis**—The Holmes syndicate has decided to cable the Broadway line here. Had the operating company been granted the necessary permission for the erection of poles, the overhead wire system would probably have been adopted. It is expected that work will be commenced by the 1st of April. The line is seven and one-third miles in length, and four cables will be used. Two power houses will be erected, to occupy the locations of the present stables, at Broadway and Salisbury street, in North St. Louis, and at Broadway and Keokuk street, in the southern part of the city. A separate cable will extend each way from each of the power houses. The California system, such as in use on the Olive street line and the Citizens' line, will be used on this line. Temporary tracks will be laid on the side of the street over which the cars will be run during the time occupied in building the road. It is intended to finish the whole line during the coming summer if possible. The road is to be one of the best that money and skill can produce.

The Benton-Bellefontaine Street Railway has decided to equip its line with electricity. It already has a franchise to use electricity on its line from Cass avenue northward. The franchise will expire by limitation unless work is commenced by the 4th of April.

**Springfield**—We understand that the Citizens' Street Railway company will put on ten or twelve motor cars in the immediate future. We understand the contract for electrical equipment has not, however, yet been let.

## MARYLAND.

**Baltimore**—We understand that the City Passenger Railway company is in the market to negotiate a loan of several million dollars in order to meet the expenses contingent upon the proposed installation of the cable system.

## NEW JERSEY.

**Newark**—We understand that a syndicate of capitalists have secured the option of the purchase of the property of the Newark & South Orange Street Railway company. It is said that the price is \$1,600,000, of which \$300,000 is to be taken in stock and the balance in cash. This company was incorporated on March 7, 1861,

with a capital stock of \$25,000, with power to increase it to \$150,000. The road is eight miles in length, and, in spite of its running through a well populated territory, proved a failure. The company became embarrassed, and the property was finally sold to satisfy a judgment. After the property came into the possession of other parties, the line was extended and the rolling stock increased and such improvements made that the road has finally become a splendidly paying institution.

**New Brunswick**—We understand that the New Brunswick Street Railway company is to be sold under foreclosure proceedings, which have been brought by the American Trust company for the benefit of the bondholders.

## NEW YORK.

**Brooklyn**—A strong effort is being made by different labor organizations to have the charter of the Atlantic Avenue Railway company annulled, the associations claiming that the strikes of last year were caused by the unlawful and barbarous conduct of President Richardson toward his employes. It is alleged by them that he compelled some of them to work more than ten hours per day, and also that he failed to run cars for six days. The judge has reserved his decision.

**Syracuse**—We understand that the Standard Oil company is behind the syndicate that is working for the consolidation of the street railway interests here.

**Utica**—Mr. W. E. Haycox, once assistant superintendent of the East Cleveland Street Railway company, of Cleveland, O., but later superintendent of the Utica Belt line, has resigned his position in order to accept one with the People's line, of Syracuse, and will enter upon his new duties about the first of March. The GAZETTE wishes Mr. Haycox all prosperity in his new appointment.

**Waterloo**—The Seneca Falls & Waterloo Railway company here has been granted permission to operate its line by electricity. The line has been operated by steam power.

**Yonkers**—The property of the Yonkers Street Railway company, including its horses, cars, stables, etc., was attached on the 1st of February by Deputy Sheriff John Kennedy. The attachment was made for two judgments—H. Alvord and Lemuel Kramer, for \$5,243.75, and the other for Mrs. Julia Hyland, for \$37,774.75.

## OHIO.

**Cleveland**—The contracts for the machinery of the new cable road now being constructed by the well known contractors, Hathaway & Robison, with Col. W. H. Payne as chief engineer, has been let. The power house will be located on the corner of Superior and Kirtland streets and will be supplied with two mammoth engines having cylinders of 38x60 inches and of 1,000-horse power each. Two cables will be strung in Superior street, one east and one west of the power house and an auxiliary cable will be run along Water street. Two cables will be strung in Payne avenue, one east and the other west of Kirtland street; and two cables in St. Clair street, one east and one west of Kirtland street. Altogether the cables will measure 140,000 feet. These cables will be operated from six pairs of immense drums in the power house, two pairs being twelve feet in diameter, two fourteen feet and two of sixteen feet. Some auxiliary machinery will be located underground in Superior street in the Public square, just east of Ontario street. A vault, the width of the tracks and twenty-five feet in length, will be built and equipped with wheels, drums and the necessary apparatus to lessen the speed of the cable for the down town portions of the street. The cars will probably be run in the business portion of the city at the rate of six miles per hour, and in the suburbs at the rate of ten miles per hour. The power house will be one story in height and will front 213 feet on Kirtland street and extend along Superior street 150 feet. It will be constructed of brick with stone trimmings. The boiler room will be located at the extreme end of the building along Kirtland street. Owing to the uncertainty of the weather the company has not dared to begin work upon the power house, but has completed all plans for its construction and equipment. The contract for furnishing concrete Portland cement has been

let to Dixon Bros. and King of New York. About 16,000 barrels will be needed and will be used at the rate of 250 barrels a day. The contract for the rails for the entire road has been given to Wharton of Philadelphia, and the contract for the cast iron and yokes to the Brooks company of this city. The company expects to have the Superior street branch in operation by July.

**Findlay**—Col. G. B. Kerper, of Cincinnati, an also president of the Findlay Street Railway company, has purchased the Lima Avenue and West Park street railway line here; thus operating about fifteen miles of road under one management. We understand the price paid was \$30,000. It is three miles in length.

**Newark**—At a recent meeting of the directors of the Newark & Grandville electric road, it was decided to complete the line as far as the Baltimore & Ohio depot, after which the contract for the equipment will be placed.

## ONTARIO.

**Toronto**—The mayor and city council have resolved to petition the lieutenant and council against granting the charter prayed for by the Brookville company for a new street railway in this city; the reason being that it is alleged that an alderman of the city is believed to be interested in the application.

## PENNSYLVANIA.

**Franklin**—The matter of building an electric railway here for both freight and passengers is being agitated; the idea being to connect with the Old Colony railway at Renham.

**Johnstown**—Johnson company has received the order for track material for ten miles of new electric street railway here.

**Lillitz**—It is very likely that a street railway will be built here in the near future. Mr. John Miller of this city is interested and is anxious to obtain all the information possible regarding the cost of the road, obtaining right of way, etc.

**Philadelphia**—The Marshall Street Railway company has commenced to lay its tracks. The traction company is pushing the work on the bridge crossing the Reading tracks to Poplar street and connecting with the Gerhard avenue tracks just below the Sedgley guard house, making a new line to the west part.

We understand the tracks will be re equipped on Market and Seventh and Ninth streets, and Columbia avenue with improved and larger cars having double the capacity of those now in use.

It is stated that the negotiations of the Lehigh Avenue Railway company to secure a lease of the Tenth and Eleventh street railway are at an end, at all events, for the present.

**Pittsburg**—The Pittsburg, Allegheny and Manchester Street Railway company has received permission to use the same motive power used by any other company.

## SOUTH DAKOTA.

**East Sioux Falls**—We understand that a electric railway will be in operation here about May 1. The cost of the line when completed will be from \$75 to \$100,000.

## TENNESSEE.

**Chattanooga**—The North Chattanooga Street Car company is having a survey made of the route proposed, and we understand that the line will be operated by means of the storage battery.

**Jackson**—Messrs. H. W. McCorry, G. G. Bond and John I. Wisdom have purchased the controlling interest in the Jackson & Suburban Street railway, and we understand that the line will be considerably improved in the near future.

**Memphis**—We understand that the Prospect Park Dummy line has about determined to operate its cars by electricity. If this is done and the change turns out to be a success, the East End Dummy line will also do the same thing.

**Nashville**—Dr. Morrow has, we understand completed negotiations for the majority of the stock of the West Nashville Dummy line. The two dummy lines will be connected by the new line.

## TEXAS.

**San Antonio**—The Lake View Rapid Transit company has a petition before the council for the construction of a rapid transit line.

## VIRGINIA.

**Richmond**—The House bill authorizing a consolidation of the Richmond Union passenger, the



Richmond street railway, and the Richmond and Manchester Street railway, has been referred to the Committee on General Laws.

The Senate has passed, under a suspension of rules, a bill to amend and re-enact an act approved March 17, 1884, to incorporate the Petersburg and Chesterfield Railroad Company.

The amendment is as follows: The said company may construct and operate a steam or electric railroad from Petersburg to Matoaca or from Petersburg to any point on the Brighthope railroad, in the county of Chesterfield, provided their line does not touch any railroad line at grade.

The bill to incorporate the Richmond, Manchester and Petersburg Electric Railway company is on the House calendar.

## NEW ENTERPRISES.

### ALABAMA.

**Birmingham**—A petition has been presented to the council for right of way to build a dummy line to East Lake. The petition is made by R. H. Pierson, J. F. Johnson, E. W. Rucker, Joe McLester and J. A. VanHoose.

### CALIFORNIA.

**Napa**—A street railway is to be built here in the immediate future.

### COLORADO.

**Denver**—A syndicate has been formed for the purpose of buying up the land owned by J. L. Ewing at the end of the South Broadway electric road, and making a park of it.

The Denver Tramway company have been granted a franchise for the operation of its system by electricity. The franchise and privileges granted are limited to twenty years.

### FLORIDA.

**Green Cove Springs**—We understand that an electric railway will probably be built here very soon.

**St. Augustine**—The city council has voted a charter for the construction and operation of an electric street railway here, the road to be in running order within one year.

### GEORGIA.

**Buena Vista**—An electric road will probably be built here in the spring.

**Columbus**—A belt line will be built round the city, dummy engines being used.

### ILLINOIS.

**Champaign**—An electric railway will probably be built from this point to Urbana in the spring.

**La Salle**—The La Salle city council has granted a franchise to the City Electric Railway company to construct an electric street railway here. The ordinance requires the company to build at least two miles of road within six months after the franchise has been accepted, and at the end of two years five miles of road must be in operation. On the question as to whether "T" or flat rail should be used, a vote was taken, the result showing that seven votes had been cast in favor of the flat rail and five against it, in consequence of which the flat rail will be adopted.

**Peoria**—We understand that Capt. John Hall, of the Fort Clark line, will petition the council for an ordinance granting him a franchise to substitute electric for mule power on his street car line. Capt. Hall was the first man to apply to the council for permission to put in an electric line, but at the time the application was made the opposition was so great that it could not be done.

### INDIANA.

**Kokomo**—The Kokomo Railway company has been granted an ordinance for the construction, maintenance and operation of a street railway here. Mr. Frank E. Baker, of Bangor, Me., is prominently identified with the enterprise. The franchise is for twenty-five years, and it is specially stipulated that when the city of Kokomo should have attained a population of 20,000, the system shall be operated with electricity, and then only such a system as may be approved by the common council. Three miles of the road have to be finished by the 1st of October. The ordinance further provides that no smoking shall be permitted on any of the cars except upon the last two seats of open cars.

### IOWA.

**Burlington**—An ordinance has been passed authorizing the Union Street Railway company to operate its lines by electricity.

**Independence**—We understand that \$100,000 has already been raised for an electric railway here, and the probabilities are that it will be built in the near future.

**Keokuk**—Articles of incorporation of the Keokuk Electric Street Railway and Power company have been filed.

**Oskaloosa**—A street railway will be built in the immediate future and be in operation by the first of August, which will be known as the Oskaloosa Street Railway company. The franchise gives exclusive right to lay the track and operate a street railway, but the right to all streets which are not occupied within five years is to be forfeited. The company pledges itself to build and have in operation a street railway one and one-half miles long by August 1. The motive power has not yet been decided upon, but electricity will probably be adopted. Over one-half the stock of the company is owned by C. B. West, J. A. Stone, R. A. McPherrin and others, of Oskaloosa.

### MASSACHUSETTS.

**Boston**—Mr. R. T. White has petitioned for authority to build an elevated railway from Post Office Square to South Boston, thence to South Boston Point and back to the square.

**Greenfield**—It is highly probable that a franchise for a street railway will be granted at this point in the near future. If the franchise is granted, there will be no delay about the construction of the road. Mr. Sumner T. Dunham is interested.

**Quincy**—The Manet Street Railway company has been organized to build a line two and a half miles long and have standard gauge. The capital stock is placed at \$35,000. (A list of the temporary directors will be found under head of elections in present issue.)

**Weymouth**—A movement is on foot to build an electric railway from this point to Hingham and to extend it through South Weymouth and South Hingham.

**Whitman**—A franchise has been granted for the construction of a street railway here.

### MAINE.

**Gardner**—The Gardner & Augusta Electric Street Railway company has been granted location for its track.

### NEBRASKA.

**Beatrice**—The Mittenberg Street Railway Co. of this city has been incorporated with a capital stock of \$30,000. The incorporators are: A. W. Nickell, L. F. Easterday, W. E. Bright, L. M. Pendington and P. A. Albright.

**Lincoln**—The Lincoln Electric Railway company has been incorporated with a capital stock of \$100,000. The incorporators are: A. H. Andrus, A. C. Ricketts, John R. Barr, A. C. Ziemer, Thomas Ryan and John S. Reid.

### NEW YORK.

**Buffalo**—We understand that the franchise for a new street railway here has been sold to Rochester parties. We know but little about this franchise, but understand that the proposed road will be fifty miles in length. The company is to be known as the Crosstown Street Railway company of Buffalo. The capital stock is \$500,000.

**Brooklyn**—A project is on foot for the construction of an arcade or depressed road on Atlantic avenue.

It is estimated that the cost of construction will be from \$650,000 to \$700,000 per mile.

**Mt. Vernon**—Several electric street railway projects are on foot here, and we have reason to believe that an electric line will be constructed very soon between Yonkers and City Island. The company will probably be formed under the name of the Yonkers, Mount Vernon and Glen Island Electric Railway company.

**New York City**—The 50th Street, Astoria Ferry and Central Park Railway company of this city has been incorporated with a capital stock of \$500,000. (A list of the directors will be found under head of elections in present issue.)

**Port Jervis**—A street railway will probably be built here in the immediate future, a franchise for the same having been granted.

### NORTH CAROLINA.

**Winston**—The Winston Electric Street Railway company of this city has been organized with Frank J. Sprague of New York City as president of the company. Construction is to be commenced at once and pushed rapidly to completion.

### OHIO.

**Salem**—We understand that Mr. T. N. Harris, of Cream Ridge, is agitating the question of building a street car line from this point to Winona.

### PENNSYLVANIA.

**Beaver Falls**—An ordinance has been passed granting the Beaver Falls, College & Metamora Electric Railway company permission to operate through certain streets here.

**Lancaster**—A belt line will probably be built around this city, with electricity as the motive power.

The street railway here has received permission to operate its cars by electricity. Mayor Egerly refused to sign the ordinance; he did not veto it, however, and it became law by default.

**Pittsburg**—We understand that a project is on foot to build an electric railway from the West End street car stables over the old Stantonville Pike to Ricefield, a distance of six miles. It is also rumored that the West End road will probably be cabled, but as yet nothing definite is known about it.

### TENNESSEE.

**Chattanooga**—It is expected that everything will be in readiness to commence operation of the electric line to St. Elmo and East Lake by the first of April.

It is probable that a dummy line will be built from Ringgold to this point by way of Chickamauga.

**Jasper**—A charter has been obtained for a dummy line here.

**Memphis**—The City Suburban Railway company of this city has been chartered.

### TEXAS.

**Austin**—The Vernon Street Tramway company has been organized, with a capital stock of \$20,000. The incorporators are Jos. Schmidt, S. W. Lomax and A. M. Britton.

### VIRGINIA.

**Manchester**—A bill has been introduced to the legislature to incorporate the River View Railway company. As far as can be learned, this bill will authorize the company to build a railway, single or double track, from here to Lake View. It is expected that the capital stock shall not exceed \$100,000. The incorporators of the road are Messrs. E. D. Starke, William Ellyson, N. R. Savage, D. Mitteldorfer, Julius Straus, E. A. Saunders, Jas. B. Harvie, Henry S. Hutzler, R. B. Chaffin, William Lovenstein and John C. Easley.

### WASHINGTON TERRITORY.

**Evansburg**—A Tacoma syndicate has been looking over the ground here with a view of putting in an electric line.

### WISCONSIN.

**Marinette**—The Marinette Street Railway company has been capitalized at \$50,000. The incorporators are H. C. Higgins, Thos. Higgins, Phillip Gaffney, Edward Schofield and J. F. Hancock.

## ELECTIONS.

**Augusta, Ga.**—The following is a list of officers recently elected for the Augusta Street Railway company:

President—Frank E. Fleming.

Directors—H. B. King, R. A. Fleming, W. H. Howard, Z. W. Carwile, T. G. Barrett, E. T. Mosher and Landin A. Thomas, Jr.

**Jackson, Tenn.**—Messrs. H. W. McCorry and G. G. Bond have been elected as directors of the Jackson & Suburban railway, vice C. P. Heath and N. A. McFaul, resigned. Dr. C. P. Heath will still remain as secretary of the road.

**Keokuk, Iowa**—At a meeting of the recently incorporated Keokuk Electric Railway company the following named gentlemen were elected as directors:

M. H. King, Charles Mitchell, O. J. Chapman, H. J. Ransom and W. H. McCanaughy.



**Lincoln, Neb.**—The Lincoln Electric St. Ry. Co. elected the following directors for the first year:

Henry T. Clark, Thomas Ryan, A. M. Gardner, A. M. Trimble, George Downing, A. C. Ziemer and A. C. Ricketts.

**New York City.**—The directors of the recently incorporated Fiftieth Street, Astoria Ferry and Central Park Railway Co. are as follows: Frederick A. Bartlett, Horace M. Ruggles, C. E. James, John W. Mersereau, Robert A. Greacen, F. C. Pemberton and Jared F. Harrison.

At a recent meeting of the stockholders of the Blecker Street and Fulton Ferry Railway company, the following were elected as officers and directors for the ensuing year:

President—John H. Selmes.

Vice-President—Isaac Hendrix.

Sec. and Treasurer—Thomas O. H. McLean.

Directors—John H. Selmes, Isaac Hendrix, John Downey, Joseph Jacobs, Alexander E. Kursheedt, M. M. White, Matthew H. Beers, Samuel M. Smith, Otis W. Randall, Thomas H. McLean, Louis S. Brush, Samuel Rowland and A. S. Rosenbaum.

At a recent meeting of the stockholders of the Sixth Avenue Railway company, the old board of directors was re-elected.

**Norfolk, Va.**—At a recent meeting of the City Railroad company here the following named gentlemen were elected as officers and directors for the ensuing year:

President—Col. Walter H. Taylor.

Secretary and Treasurer—H. C. Whitehead.

Superintendent—James J. Ferris.

Directors—N. G. Miller, of New York; Capt. James W. McCarrick, Major A. Myers, W. A. Marable, Judge James E. Heath, William A. Graves, Jr.

Executive Committee—Capt. James W. McCarrick; N. G. Miller, of New York; W. A. Marable.

**Quincy, Mass.**—The following named gentlemen have been elected as directors of the recently organized Manet Street Railway company, pending permanent organization:

George H. Wilson, William H. Doble, Albert D. S. Bell, John H. Dinegan, George W. Morton, James D. Taber, Arthur D. McClellan.

## EXTENSIONS.

**Arvada, Cal.**—An effort is being made to get the Berkeley Motor Electric Railway company to extend its line to this point.

**Denver, Colo.**—We understand that the City Cable company will extend its line to the lake in the immediate future.

**Chattanooga, Tenn.**—The City Street Railway company is arranging to improve an extended system into the suburbs.

**Des Moines, Iowa.**—It is very probable that the Twelfth street line will be extended north to the Des Moines river, and on North street west to Twenty-first street.

**Marlboro, Mass.**—It is understood that a strong effort is being made to extend the street railway here to Hudson, but the project has not assumed definite shape.

**Moline, Ill.**—The Moline Central Street Railway company has an ordinance in the council petitioning for right of way for some important extensions of its system.

**Oakland, Cal.**—The Fourteenth Street Railway company will extend its line this spring.

**Warrensburg, Mo.**—The electric street car line here will probably be extended at once.

**Worcester, Mass.**—The consolidated horse railway company of this city will probably be extended to Greendale at once.

## TOO LATE TO CLASSIFY.

**Butte City, Montana.**—A new electric street railway has been incorporated at this place and the franchise has been granted. The following named gentlemen are interested: Wm. L. Hoge, Francis E. Sargeant, G. W. Dickinson and Chas. S. Warren.

It is expected that the road when finished will cost in the neighborhood of \$150,000.

**Des Moines, Iowa.**—The council has just authorized the Des Moines Street Railway company to extend its lines. We understand this is

for the extension of the Sevastopol line and its conversion into the electric system.

**Duluth, Minn.**—The Duluth Motor Line company has been incorporated, with a paid up capital stock of \$600,000. The incorporators are: A. R. MacFarlane, R. M. Hunter, G. G. Hartley, M. J. Forbes, H. M. Peyton, J. A. Willard, A. S. Chase, Joseph Sellwood, J. D. Stryker, S. L. Seldon, J. H. Upham, Simcoe Chapman, J. D. Howard, J. Mannheim, Cochrane & Walsh, Coffin & Warner, C. Markell, and others. A motor line will be built just as soon as the frost is out of the ground. Cars will run out six miles to Pike lake, a lovely sheet of water, which is to be turned into a pleasure resort, with hotels, etc. The intention is to start some new manufacturing enterprise there, the particulars of which the incorporators will not reveal. They and others have secured an immense amount of acreage about five miles from the city.

**Helena, Montana.**—The Sullivan-Power motor franchise has been amended, and compels the company to commence work within 100 days, and to have electric motor cars running by the first of September.

Mr. H. M. Keefe has applied for a franchise for a street railway on Broadway in this city. The matter was referred to the street and alley committee, as was also the application of Mr. R. F. Wallace for permission to construct a street railway on Main and Sixth streets.

In order to give street railways and other corporations better opportunities to place their bonds, an ordinance has been introduced into the council here to extend the right of franchise from twenty to thirty years. Another ordinance was introduced into the council lately by G. L. Palmer requesting permission to build a street car line on Main street and Sixth avenue to Broadway, etc. The matter was referred to the street and alley committee.

**Hopkinsville, Ky.**—The franchise granted last year to S. H. Turner et al. for the exclusive right of way to build and operate an electric light and street car line for twenty-six years at this place has been repealed by the council as far as the exclusive rights are concerned.

**Milwaukee, Wis.**—At a recent meeting of the directors of the Cream City Railroad company, the following named gentlemen were elected as officers for the ensuing year:

President—Henry C. Payne.

Vice-President—Christian Preusser.

Treasurer—Ferd. Kuehn.

Secretary—Wm. Damköhler.

**Pittsburgh, Kan.**—At a recent meeting of the stockholders of the Pittsburg Electric Railway company, the following named gentlemen were elected as directors for the ensuing year:

B. F. Hobart, of St. Louis, Mo.; A. E. Stillwell, of Kansas City, and Frank Playton; H. B. Wilson and F. E. Doubleday, of Pittsburg.

The Pittsburg Electric railway has been incorporated, with a capital stock of \$50,000. (A list of the directors will be found under head of Elections in present issue.)

**Steubenville, Ohio.**—The Market street and Pleasant Heights street railway has been incorporated, with a capital stock of \$50,000.

**Troy, New York.**—At a recent meeting of the stockholders of the Watervliet Electric Railway and Turnpike company, the following were elected directors for the ensuing year:

James B. Germain, Charles Newman, J. N. Tillinghast, John J. Acker, Ledgyard Cogswell, W. B. VanRensselaer, J. Howard King, A. N. Brady, Thomas A. Knickerbocker, of Troy.

Mr. H. McL. Harding, general agent of the mining department of the Sprague Co., has been somewhat annoyed within the last few days on account of a confusion of names. It appears that one, F. R. Harding, was engaged by the Sprague Co. some time ago to handle some special work in the south, and amply supplied with funds for that purpose. As far as we can understand, instead of transacting the business he had in hand, he spent his time at the Gibson House in Cincinnati, and other places, in enhancing his reputation as an expert billiardist. We are informed that he represented himself, while there, as being the general agent of the Sprague Co., and that he cut a pretty wide swarth in that section of the country, and did not hesitate to use

his alleged official position with the company as a means of replenishing his depleted exchequer.

Friends of Mr. H. McL. Harding can thus readily see how he has been subjected to the annoyance of his name being confused with that of the erst-while employee of the Sprague Co.

One of the features at the electrical exhibition at Kansas City was the display made by the Royal Silk Manufacturing company of 2 and 4 Stone street, New York. This firm is manufacturing a silk machine towel to take the place of cotton waste. It has many advantages over waste; namely, it is non-combustible, has great absorbing powers, leaves no lint or fibre on the machines, and can be washed from thirty to forty times, thus making it, in practical use, 50 per cent. cheaper than waste. All the large factories, mills, electric light and car works have it in practical use, and, from what we have heard, it is giving entire satisfaction in every instance. There is also a movement on foot by the insurance companies to make a reduction in all plants and factories where these goods are used.

The Robinson & Moan Car company of Minneapolis and Chicago has been awarded the contract for the construction of twelve new cars for the Elgin Street Railway company, to be delivered about May 1st. There are to be nine closed and three summer cars, and will be finished in solid bronze and nickel. We learn that, according to the specifications, the interior wood finish is to be of bird's-eye maple, and each car is to have seventeen coats of paint.

The U. S. Steam and Street Railway Advertising Company of Chicago and Boston sends us a handsome calendar, adorned with a picture of "Reynard," and a sketch of a fox hunt, the fox, of course, being in the lead, and the hounds, in full cry, making a good second.

The India Rubber and Gutta Percha Insulating company, of New York, had quite a large exhibit at the convention, showing end sections of various kinds of cable, and conductors having the famous Habir shaw insulation.

## Acknowledgments.

The GAZETTE desires to make the following acknowledgments:

To the WESTERN ELECTRICIAN of Chicago for their courtesy in the loan of the cut of the Westinghouse Engine and Dynamo shown in the February issue. Owing to an error, credit for the loan of the cut was not given that enterprising paper at the time.

To the CENTROPOLIS HOTEL, of Kansas City, and its most accommodating manager, Mr. J. T. CLYDE and his able assistant, Mr. Venable; likewise to the COATES HOUSE for many courtesies rendered to us during our stay at the N. E. L. A.

To Mr. HARRY E. HELLER, of Allentown, Pennsylvania, traveling passenger agent of the Chicago, Burlington & Quincy railroad, for many courtesies extended to us while on the famous "Electric Limited," and also during our stay in Kansas City.

To Mr. A. J. MEYER for courtesies extended to us in Kansas City, especially, that of dividing his space in the Casino with us.

To Mr. HORACE A. KEEFER, of Kansas City, for his most courteous treatment and entertainment.

To each and every member of the RECEPTION COMMITTEE for their kindness to us while in the city.

To the METROPOLITAN STREET RAILWAY COMPANY, likewise to the INTER-STATE RAILWAY COMPANY for courtesies extended.

To Mr. D. B. DEAN, of the "Electric Review," for many kind acts rendered during the convention.

## FOR SALE.

SUBJECT PRICE SALE—Have 3 Baldwin and 3 Porter Motors, various sizes; 7 Steam Motor Cars, together with a number of Horse Cars, and 750 tons 40-lb. Steel Rails.  
HORACE A. KEEFER, KANSAS CITY, MO.

## DIVIDEND.

THE semi-annual dividend of the Danbury and Norwalk Railroad Co., of one dollar and twenty-five cents per share will be paid by the Assistant Treasurer of the Housatonic Railroad Co., Feb. 15, 1890. The transfer books will be closed Feb. 5, and re-opened Feb. 27.  
G. E. ROBINSON, ASST. TREAS.

FOR SALE.—Owing to the fact of the equipping of our line electrically we will have for sale, about February 1st, 125 head of horses and fifty head of mules, all middle age stock and thoroughly adapted for street car work. Can sell and deliver 50 head of the above at any time. Also have 14 box cars and eight open cars 12, 14 and 16 feet long, mostly all Stephenson and Pullman cars. Can deliver open cars at once. Will sell at low price and easy terms to responsible parties. Call on or address SIOUX CITY STREET RAILWAY COMPANY, Sioux City, Iowa.

FOR SALE.—Two 1H, 1K Porter Standard Gauge Dummies; One Baldwin Engine and Car Combined, at a very low price. For particulars address THE RIVERSIDE AND SUBURBAN RAILWAY CO., WICHITA, KANSAS.



Electric Street Railways in North America.

IN OPERATION OR UNDER CONTRACT FEB. 22, 1890.

Table with columns: OPERATING CO., LOCATION, SYSTEM, CARS, MILES. Lists various street railway companies and their details.

Table with columns: OPERATING CO., LOCATION, SYSTEM, CARS, MILES. Continuation of the list of street railways.

Bond Offerings.

Table listing bond offerings with columns: OFFERED BY, Rate, Price, Pays, Amt. Offer'd, Mature, Int. Pbl., Miles Bnd. p.M., Issue, Net Earn'gs.

Among the Exhibitors.

The Ball Engine company, of Erie, was represented by Mr. W. B. Pierson, the Chicago manager. Mr. Geo. B. Cutter exhibited a handsome line of specialties, such as Cutter shades, simplex wires, etc.

the Standard Paint Co., sole manufacturers of the celebrated P. & B. Paint & Electrical compounds, and was showing samples of wood saturated with P. & B. paint, and one piece of wood which he was showing looked exactly like ebony.

English, Morse & Co., of Kansas City, had a splendid exhibit of engineer supplies and a large "ideal engine," which was driven by a belt connected with a motor in another exhibit.



the way, unequalled by any fare box yet placed upon the market.

Of course Brother R. J. Randolph, who, hereafter will be known as Drum-major Randolph, attended to the business of the Excelsior Electric company. Just what the convention would have done without Mr. Randolph, nobody knows.

Wm. Baragwanath & Son, Chicago, showed a number of banners descriptive of their famous feed-water heater.

Grimshaw tape and wires were thoroughly taken care of by the genial J. W. Godfrey, who had his exhibit as part of that of the South Western Electrical Supply company, of St. Louis, Mo.

John Roebing Sons' Co., of Trenton, N. J., was represented by George C. Bayley, of Chicago, who exhibited a line of wires for almost every purpose.

Messrs. Alex. Kempt, of Chicago, and C. C. Curtis, of Cleveland, attended to the business of the Brush Electric company.

H. A. Woodruff, Esq., of Davenport, Iowa, represented the Hawkeye Manfg. company of that city.

Holmes, Booth & Haydens, of New York, were represented by H. P. Lucas.

Messrs. W. T. Buckley, of Chicago, and Charles Knight, of Fort Wayne, represented the Fort Wayne Electric company.

The Triumph Compound Engine Co. had a beautiful model of its engine and was represented by the secretary of the company, Mr. Hobart.

Messrs. Webb C. Hayes, B. F. Miles and W. H. Lawrence attended the convention in the interests of the National Carbon company, of Cleveland.

A good display was made by the American Leather Link Belt Co., of New York.

Mr. A. H. Patterson had charge of the exhibit of shades, globes, etc., of the Phoenix Glass company.

Capt. H. A. Glasier, of Chicago, represented the business of J. A. Grant & Co., of Boston.

Messrs. J. B. Crouse and W. W. Lowe represented the business of the Standard Carbon company, of Cleveland, Ohio, showing all kinds of battery, carbon brushes, rods, etc.

Mr. H. J. Conant was well supplied with a number of photographs for the purpose of explaining the system of the Evans Friction Cone company, of Boston.

Messrs. Geo. E. Pyle and L. A. Boyd exhibited a number of photographs of the electric headlight, made by the National Electric Headlight company of Indianapolis.

The Fishkill, Landing Machine company, of New York, distributed a number of cards descriptive of the Fishkill-Corliss engine.

Col. J. H. Shay exhibited a 48-inch belt in

behalf of the Charles Munson Belting company, of Chicago.

A magnificent display was that of the Eddy Electric Manufacturing company, of Windsor, Conn. The company was represented by Messrs. M. E. Baird, A. D. Newton, W. L. Osborn and E. H. McFall. In their exhibit they had a one-horse power, 2-horse power and 5-horse power reversible motor, especially adapted for elevator service; also a 5-horse power ordinary stationary motor; they also had one of their motors driving an engine of from 30 to 60-horse power.

Mr. Daniel Russell, G. Parker and G. W. Hazeltine attended to the business of the Parker-Russell company, of St. Louis.

Mr. C. G. Armstrong, of Chicago, had an exhibit of some of the specialties of the Monitor Electric company.

Messrs. H. Lufkin & Floyd Platt had charge of the exhibit of the C. & C. Motor company, of New York. The exhibit consisted of several large motors, ranging in size from 3-horse power up.

Mr. J. F. Kelly looked after the exhibit of the Edison Machine works, of Schenectady, N. Y.

The Ansonia Brass & Copper company, of Ansonia, Conn., was represented by Dr. Gilbert M. Smith.

Mr. Ernest Horfer, Chicago manager of the Bishop Gutta Percha company, had a full line of samples of the goods of this company.

The Fred H. Whipple Company, of Detroit, showed a number of their books published by it pertaining to electrical matters.

Mr. Paul W. Bossart represented the Perkins Electric Lamp company, of Manchester, Conn.

The Okonite Company, of New York City, had a handsome display of Okonite wires, sub-marine cables, insulated with Okonite; Manson tape, etc.

Mr. A. L. Ide, of the firm of A. L. Ide & Son, of Springfield, Ill., attended the convention in the interest of his new "Ideal engine," which was exhibited by his local agents, Messrs. English, Morse & Co., of Kansas City.

Dr. S. S. Wheeler, of New York, represented the Crocker-Wheeler Motor company.

The interests of the Thomson-Houston company were ably attended to by Messrs. George Atkinson, Edwin Floyd and Chas. S. Rusling.

Mr. W. S. Turner, of the firm of Woodbridge & Turner, of New York city, attended the convention in the interest of his firm.

Mr. S. S. Leonard looked after the interests of the Hill Clutch Works, of Cleveland, Ohio, and we understand that he secured several good orders.

Mr. C. E. Gregory represented the Sperry Electric company of Chicago.

Mr. Charles A. Schiren of New York City,

had a magnificent exhibit of his perforated electric leather belting.

Mr. M. T. Mulford, of Kansas City, attended to the business of the Goodyear Rubber Co.

The Westinghouse Supply company, of St. Louis, had quite an exhibit in charge of its president, Mr. T. J. Wilson.

Mr. Frank G. Pond, president of the Pond Engineering company, was on hand with copies of his new paper, *The Western Engineer*.

The Detroit Motor company made its second exhibit of motors, varying in size from 7½ h. p., weighing 800 pounds, to 1-20 h. p., weighing 4 pounds. The mechanism of these motors is complete to the minutest detail, and their automatic switch was one of the interesting features of their exhibit.

The Young's automatic safety cut-out was exploited by the Royal Electric Specialty company, of New York city.

Johns, Pratt & Co., of Hartford, Conn., were looking after vulcanized asbestos packings and insulations.

The Eureka Tempered Copper company, of North East, Pa., was represented by A. L. Daniels, who showed some cast commutator segments, Washburn trolley wheels, rolled brushes of pure copper, etc.

"Okonite" received considerable attention at the hands of Mr. W. H. McKinlock, of the Central Electric company, of Chicago.

David Chalmers, Esq., attended to the business of the Empire City Electric company, of New York.

Mr. J. W. Lynch, president of the Washington Electric Conduit company, represented his company at the convention and had a number of samples of their conduit to show.

Bernhard H. Schmidt was kept very busy the whole time explaining the merits of Brill's independent rigid truck. We may say that this exhibit attracted probably as much attention as any other in the convention.

J. A. J. Shultz, of St. Louis, was, of course, on hand with samples of his new leather woven link belt—an admirable invention. He also showed some of his patented leather pulley covering (which was illustrated and described in our February issue).

Mr. Frank P. Wisner looked after the business of the Consolidated Fruit Jar company, of New York. This concern also manufactures sheet-metal specialties.

The Reynolds-Corliss engine made by the Reliance Works, Milwaukee, Wis., was taken care of by Mr. J. B. Allen, of Chicago, manager for E. P. Allis & Co.

Samples of wire belting, with special pulley covering, were shown by the Midgley Wire Belt company, of Beaver Falls, Pa.

## CELLULOID RAILWAY CHECKS,

THE BEST SUBSTITUTE  
FOR SMALL CHANGE.



SEND FOR

PARTICULARS TO

CELLULOID NOVELTY CO., 313 & 315 Broadway, NEW YORK

LIGHT, HANDSOME,  
DURABLE.

OUR BELTING IS TANNED ON THE SURFACES ONLY. INTERIOR IS RAWHIDE. The only perfect Belt made No shipping or lost motion.

SEND FOR OUR VALUABLE BOOK. FREE.

ST. LOUIS, MO.

ALSO RAWHIDE LACE LEATHER.

AGENTS IN ALL CITIES

## RAILWAY PATENTS

Low Rates. Reliable Work.

### HIGDON & HIGDON,

Mechanical Experts, and Solicitors of American and Foreign Patents.

St. Cloud Building, (Opp. U. S. Patent Office), WASHINGTON, D. C.

Also, HALL BUILDING, KANSAS CITY, MO.  
SCHMIDT BUILDING, PITTSBURGH, PA.  
RODEN BUILDING, BIRMINGHAM, ALA.  
S. W. COR. 8TH AND OLIVE STS., ST. LOUIS, MO.

Established 1878. We have protected hundreds of friends.

### FINE DRAWINGS

A Specialty. Printed copy of any patent referred to in this paper for 25 cents in stamps.

TRADE MARKS. Manufacturers, Protect Your Name and Trade-Marks by Letters-Patent. Write us for Instructions, cost, etc.

## STREET CAR VARNISHES

FINEST IN THE WORLD.

PARROTT VARNISH COMPANY,

BRIDGEPORT, CONN.



# The Street Railway Gazette.

(Copyrighted, 1890.)

VOL. V.

CHICAGO.

APRIL, 1890.

CHICAGO.

No. 4

## Compound High Speed Engine.

FOR ELECTRIC STREET RAILWAY SERVICE.\*

The rapid advance made in steam engine practice, in the direction of increased economy and improved methods of operating, is exemplified in the engine illustrated herewith, which is one of a number built expressly for the new station of the Edison Electric Illuminating company, of Brooklyn, one of the model stations of the day.

The objects aimed at in the design of this engine were, economy of steam construction, perfect regulation, minimum space occupied, and the production of a convenient and reliable unit of power.

The results have been most flattering, and the builders are to be congratulated on their success and upon their faith in the ability of the engine

to fulfill the extraordinarily severe specifications upon which the design was founded.

to fulfill the extraordinarily severe specifications upon which the design was founded.

to fulfill the extraordinarily severe specifications upon which the design was founded.

to fulfill the extraordinarily severe specifications upon which the design was founded.

ciate the results obtained, and that this type of engine will receive deserved recognition in the great field of electric street railroad work now so rapidly developing.

The results expected, by the adoption of higher steam pressures and compounding, have been fully realized; the arrangement of the cylinders divides the strain and gives a quieter-running engine, especially when run compound-condensing.

This engine is offered to the street railway trade with the conviction that it embodies features which will commend it to their patronage, and that better service can be rendered by the adoption of the most improved methods of operating, which are exemplified in its design.

## New Electric Road in the South.

We understand that a Northern syndicate has secured control of the electric interests in the towns of Winston and Salem in North Carolina, and that an electric line connecting the two towns will soon be installed. The line will be five miles long, and will include six cars. The Sprague system of overhead wiring will be used. The dynamos will be located in the electric light station, which will hereafter supply both light and power for the street cars and general industries along the line.

This is probably the first station in the country from which will be distributed electric power for street railway and general industries, and light by both arc lamps and incandescent.

Although electric roads are now in operation

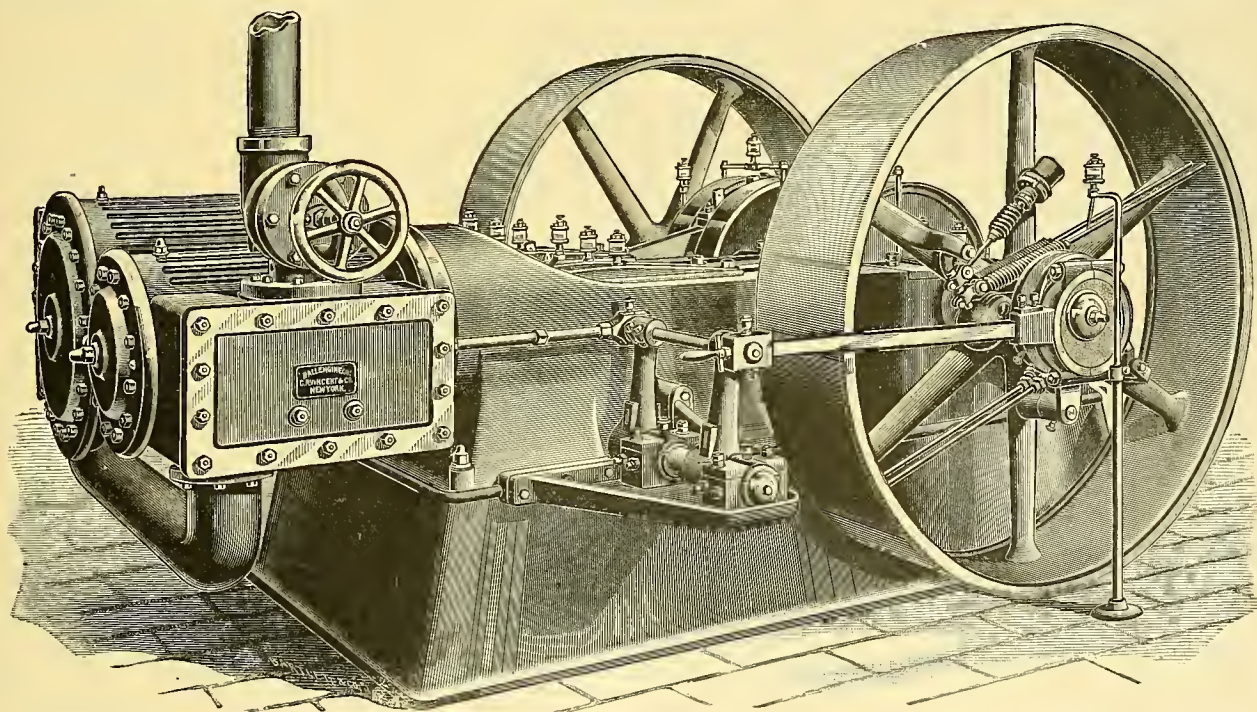

## Newark (N. J.) Street Railways.

The last annual statements of the Newark street railroad companies recently sold out to a Philadelphia syndicate, have just been filed with the state board of assessors. The total cost of all the street railroads represented, including the four railroads of the Essex Passenger Railway company and the Newark and Irvington Railroad, the Newark and South Orange Railroad, the Elizabeth and Newark Railroad, and the Orange and Bloomfield Crosstown Railroad, is \$3,419,438.26; the total stock, \$1,067,125; the total bonded debt, \$1,728,000, and the total gross receipts last year, \$1,028,349.04. The expenses were nearly 70 per cent. of the receipts. The roads have been sold for about seven million dollars, or more than double their cost to the owners.

pretty generally throughout the Northern and Western States, the use of electricity as a method of propelling cars has not as yet met with such wide adoption among the cities of the Southern States.

There are, it is true, a number of cities in the South where there are electric roads in operation, or in process of construction, but the horse and mule are still relied upon in most cities for the operation of the street cars. Northern capital, however, is rapidly developing many of the Southern towns, and a few years changes a locality from a condition of inertness to one of business and enterprise.

Salem—Winston is a good example of the progressive town of the new South, and shows by its enterprise in electrical enterprises, that it is fully awake to the latest of modern improvements.

to fulfill the extraordinarily severe specifications upon which the design was founded.

This faith, backed up by practical skill and first-class workmanship, has given to the trade an engine in every way worthy of the confidence of steam users, and one which has withstood the most severe tests, coming out in each case with flying colors, and developing a large percentage above its rated power without strain or failure in any respect.

Actual tests in service have demonstrated an economy 40 per cent. better than that obtained with any single cylinder engine, running non-condensing, in stations operating the same system, under precisely the same conditions of load, steam pressure and handling.

It is to be hoped that steam users will appreciate

\* Charles R. Vincent & Company, No. 15 Cortlandt St., New York.



**The Neversink Mountain Electric Railway at Reading, Pa.**

This electric railway, which is now being built on the "Sprague System" by the Equitable Electric Railway Construction company, of Philadelphia, differs considerably from ordinary electric railways, inasmuch as it is a mountain road, and will be used especially for carrying excursion parties to the various picnic grounds along the Neversink Mountain.

Commencing on the outskirts of the city of Reading, the road runs for eight miles along the sides of the mountain, sometimes on the very edge of a high precipice, and through deep cuts, and over high trestle bridges until the summit is reached, where a beautiful view of the surrounding valley is to be had.

The electrical equipment of the road will consist at present of four eight-wheel thirty-foot open cars, with seats facing the front. These

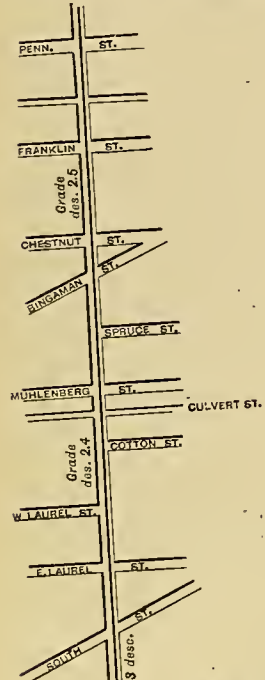

have connected their main line with the Neversink line, as they expect to bring excursions on from distant points.

A large pavillion on the top of the mountain will cater to the wants of the excursionists. Water will be pumped by an electric pump to the various pleasure spots, from a spring of clear water further down on the side of the mountain.

Ample attractions will be provided for the amusement of visitors. An electric toboggan slide and electric swings are already being built.

The electrical part of the road is being done by Mr. E. W. Courtney, of the Equitable company, under the direction of the company's chief engineer, Mr. W. A. Stadelman. The superintendent of the Neversink Road is Mr. Paul Millholland.

**Storage Batteries.**

Col. E. H. Hewins, General Manager of the Union Electric Car Co., read a paper on the application of storage batteries to street car propulsion, before the Society of Arts, in Boston, on the evening of March 27th. There was an unusually large attendance, Gen. Francis A. Walker presiding. In opening his paper Col. Hewins spoke of the problem of street railway transportation as one worthy the attention of any one desiring to serve the public. The horse cars had had their day and must give way to some better means of rapid transit, and at first sight it seemed that nothing could effect the desired result except elevated roads. The question might well be asked, why not two-story streets as well as two-story houses? Setting aside, however, the question of an elevated road, the means of improving the present surface system of street railway transportation might well be considered. It was not his purpose to enumerate the advantages of cars propelled by storage batteries over those taking their power from overhead wires,

teeth in one being broken out and all the teeth in one of the raw-hide ones entirely stripped off. In contrast to this Col. Hewins exhibited one pinion of the train of gearing invented by Mr. W. L. Stevens. This gearing ran in a bath of oil, and the pinion shown, practically without wear, had done over 8,000 miles of railway work. Thorough cleanliness and lubrication were the secrets of the endurance of the gear. The noise with this gear was very much less than with the kind commonly in use, and the lecturer believed that fully one-half less power was required to run a car than under the ordinary system of gearing. The cars also ran more smoothly.

Another important feature of Mr. Stevens' invention, continued Col. Hewins, was the "re-charging device." This invention consisted in rendering a machine either a motor or a dynamo as occasion required, and in making the change automatically. The change was accomplished by putting a few cells of the battery into a shunt circuit with the field coils of the motor. With these cells the field was kept charged in the right direction, and when the power was shut off and the car going down hill, or when the speed was too great, the motor was converted into a dynamo and the battery partially recharged by its action or the speed controlled perfectly without the action of the brake. The invention was equally applicable to overhead as well as storage systems. With this system the energy of the ordinary brake employed by other systems to hold the car from going faster than was desired or to bring it to a stop was returned to the battery to be used over again in the storage system, or to the line to reduce the power generated at the power house in an overhead system. The amount of energy so returned to the batteries on the Beverly and Danvers Street Railway (storage battery system), was by careful measurement determined to be about 14 per cent of that

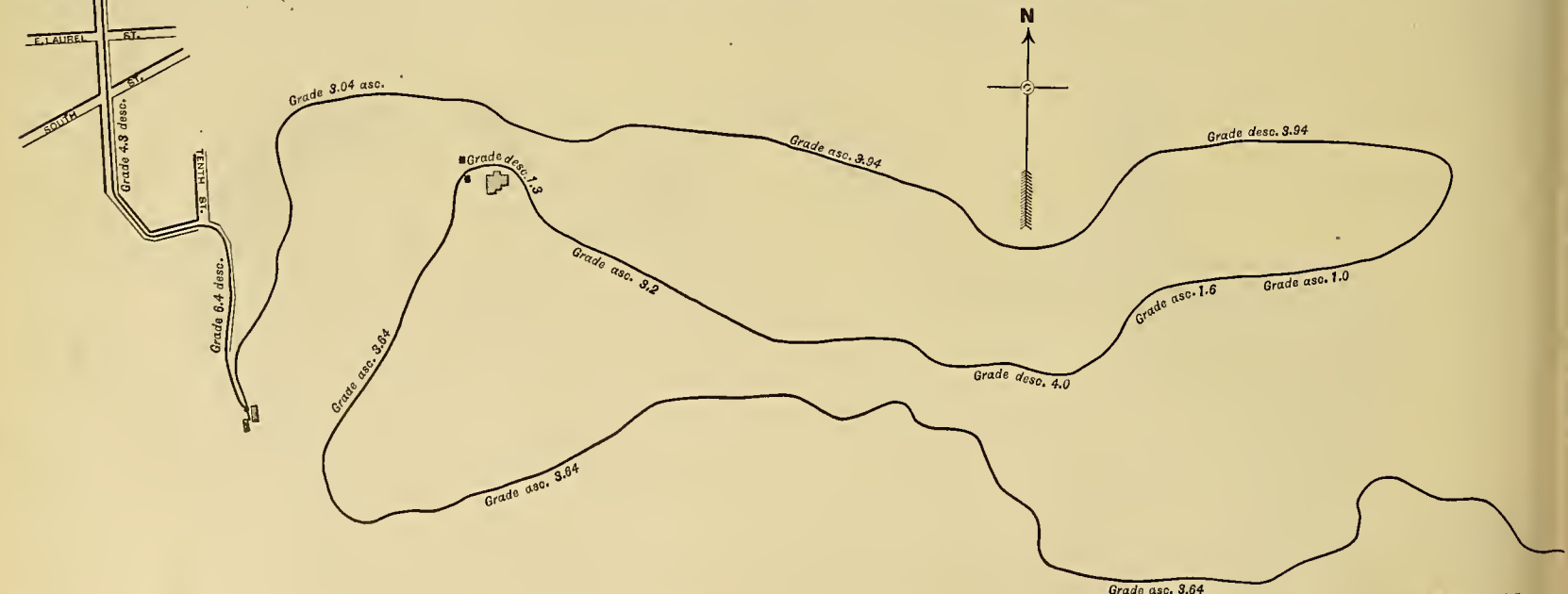

cars are being made by the Brill company, and will each be equipped with two 15 h.p. Sprague motors.

The generating plant has 500 h.p. of Victor turbines, while two 80,000-watt Edison generators will at present supply the necessary current.

In the construction of the road some very difficult features had to be met and overcome, which are so far new in electric railway construction, especially where for over one-fourth mile the road winds along the edge of a high precipice, where it was impossible to plant poles, and the overhead wires are fastened by rings and brackets directly to the rocks.

On the entire road there is no grade over 3.5 per cent, although there are over 200 curves, besides fourteen turnouts, necessitating the use of over 1,000 pull-off brackets.

The road is being laid with 58 lb. steel T rails, and is being constructed in a thoroughly substantial manner. The power station will be built with a house over it for the electrician to live in, and it is the intention of the company to supply power from the station to users in Reading and vicinity.

The Philadelphia & Reading Railroad Co.,

for they were obvious, but it was his purpose to explain what had been done with the storage batteries and what might be expected in the future.

Col. Hewins then exhibited specimens of the two styles of batteries generally used, one in which the idea was that the greatest possible surface be exposed to the solution, and the other in which mass of material, rather than surface, was believed to be most advantageous. In either case, he said, the idea was to deliver power at as low a rate as possible and at the same time reducing to the lowest possible point the waste of the active material in the battery. Which method would best effect the result the advocates of each would probably never agree. There was, however, one thing agreed upon, and that was that fully one-half the electrical energy was consumed in overcoming the friction of the gear necessary to reduce the armature speed to the required axle speed. With the gears in general use there was also much wear due to the friction, and the life of these gears was only about a couple of months.

Specimens of gears were here shown, in which friction and wear were plainly exhibited, several



taken out, while the increased mileage resulting therefrom with same amount of power supplied was about 9 or 10 per cent. The speaker believed that by this invention enough power was saved to enable the storage battery even in its present development to do the work required of it. He also believed that the frequent recharging of the batteries while in service increased their endurance.

Col. Hewins then illustrated the system by stereopticon views and explained its working in greater detail. He also said in answer to a question that on the Beverly and Danvers road the batteries were recharged after 30 miles of work. On an ordinary level road the recharging would be done only every 40 miles.



Electric Cars in a Snow Storm.

A view taken during the recent snow storm in Boston, is shown in the accompanying illustration. It was exceedingly unfortunate that during this snow storm there was a stoppage of the

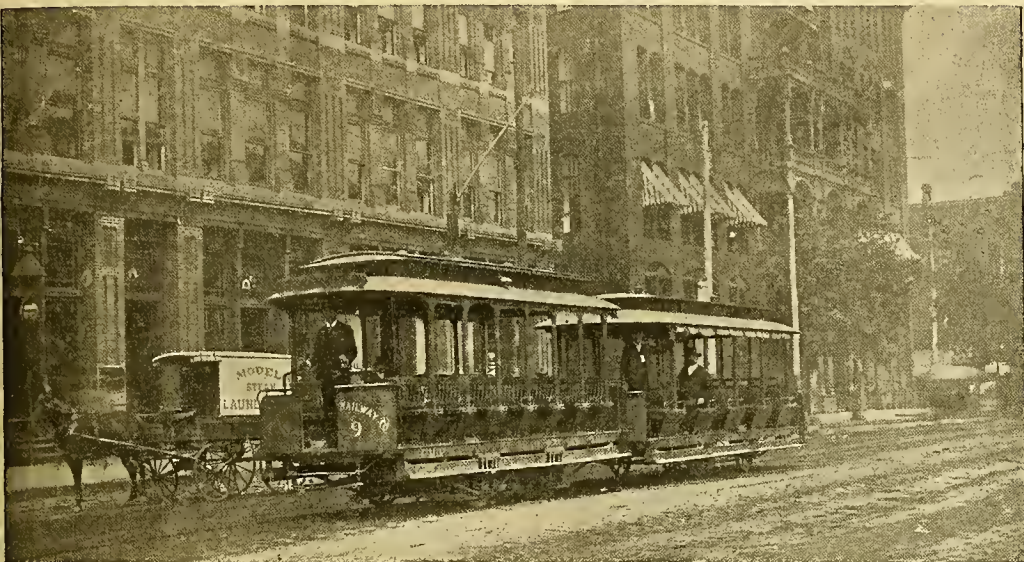

Electric cars at just about six o'clock, which was very inconvenient to the travelling public, and served to cause a good deal of criticism on the system in general, which criticism is not merited, for the facts of the case simply are; that an attempt was made to do much more work than there was power for at the generating station. As can readily be seen, it requires more power to operate cars under the many difficulties of that day of snow and ice, and pushing snow sweepers than under ordinary conditions.

When the machines became overloaded, of course they were obliged to shut down, and although several attempts to start up were made, the fact was that as soon as the current was turned on, every car on the line would attempt to start, which would cause another overload, and thus prevent any of them from starting; until affairs were so arranged that the cars were started in certain numbers.

While sufficient power is at hand to maintain an efficient and reliable service under normal conditions of travel and severe weather, it had not been exactly determined how much power it took to operate the cars in a severe snow storm, as in the present instance. In justice to the system, however, it is but fair to say that there was no trouble with the electrical apparatus, either with the motors, or any of the appliances used on the car, or the generators, or any of the apparatus used in the generating station. Of course this delay was unfortunate, but as it is a matter which can be easily remedied, it should not be taken either to reflect upon the West E d com-



pany, or the system employed in the operation of the cars. As the Boston Herald puts it: "The system has not failed, but those who have put it on, have not taken into sufficient account the magnitude of the demand that might be put upon it."

Low Speed Automatic Engine.\*

The present demands upon a steam engine are quite different from those of twenty or even ten years ago. The advent of electric lighting brought a necessity for absolute regulation of

speed, and what had in general been considered close enough regulation proved entirely inadequate to the new conditions. As the problem was soon solved, as all such problems are in this country, and, as, not only for electric work, but for other classes of work, engines of perfect regu-

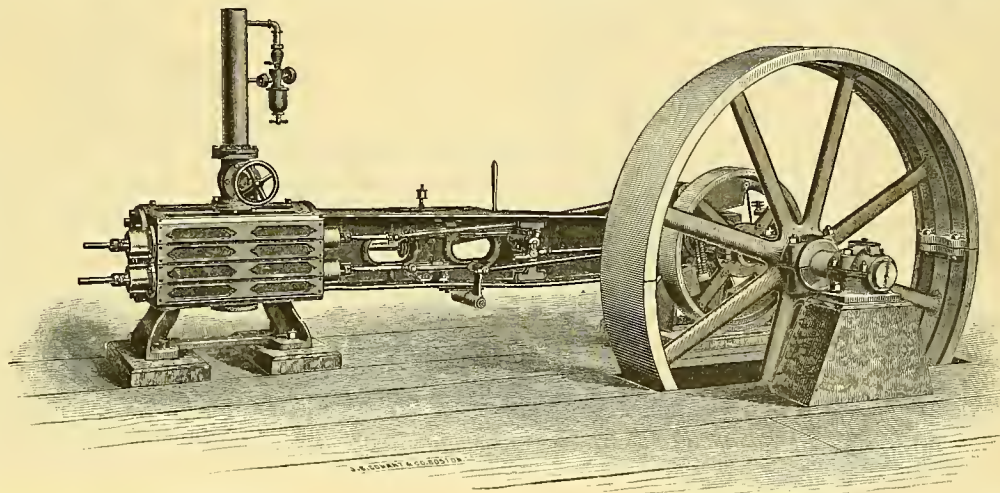

lation were installed, it was seen that while for electric lighting this evenness of rotative speed was necessary, for all classes of work it was greatly to be desired, as the maximum product could be obtained all the time, and in many cases a superior product would result. With a

For this reason high speed engines came at once into prominence, and have filled a large place. At the same time, builders of low speed engines were trying to attain the same result without high rotative speed, and the consequence has been a very marked advance in this direction by many of the prominent builders, with a decided increase in rotative speed, or to such speed as their respective valves could be properly worked at, and metal could be properly distributed for.

Realizing that the rotative effect of a given fly wheel is as the square of its number of revolutions, the advantage of an increase in rotations can readily be seen so far as efficiency of a wheel of given weight is concerned. The efficiency of one hundred pounds in the rim of a wheel at one hundred revolutions is more than double that of the same weight at seventy revolutions; at ninety revolutions is 65 per cent. more, and at eighty revolutions is 30 per cent. more. Incandescent lamps will allow no appreciable acceleration or retardation in the fly wheel during the stroke, hence the latter must be of sufficient inertia to equalize to the lamp the extremely unequal action of the steam in the cylinder, owing to the automatic cut-off needed for economy. This requires for an engine of seventy to eighty revolutions an excessively heavy fly wheel, bringing undue friction upon bearings and requiring expenditure of power to keep it in motion.

If a medium speed can be obtained without sacrificing any of the economical, and otherwise valuable, features of the slow speed engines, it would evidently be in the line of close regulation

with lighter fly wheels; more nearly parallel belts from the fly wheel to receiving pulley; and an engine requiring less attention than a high speed engine, with larger economy in the use of fuel.

The engine we herewith illustrate is one which is designed for, and is usually run at, a speed about one-third faster than releasing valve gear engines of equal power can be successfully run at, while it can readily and with entire economy and satisfaction be run one-half faster. It can also be run as slow as may be desired, at times but sixty-five revolutions being used. It has entirely independent steam and exhaust valves, so that any desired lead opening, exhaust release or exhaust closure can be given, all such adjustments being outside the cylinder and readily cared for. The valves are all perfectly balanced, and are adjustable to take up all wear during the life of the engine. The steam valves are actuated by a wrist plate, and are double ported the equivalent of a four ported gridiron valve, thus giving a perfectly free admission of steam at as near boiler pressure as the piping to engine will permit.

The clearance of the engine is very small, running from 2 1/2 per cent. in larger sizes to 3 per cent. in smaller sizes.

The automatic governor is upon the shaft and has several patented features, one of which allows the possibility of slow running, without dashpot or friction, giving an instantaneous response to any change of load, and the makers guarantee that the main belt may be instantly cut when engine is under full load, or the same load be instantly thrown on, with not to exceed 1 1/2 per cent. in increase or decrease in speed.

\* Fitchburg Steam Engine Co., Fitchburg, Mass.



**Lattice Work Pole for Overhead Wire.\***

When recently in Albany, N. Y., we noticed that the Albany Railway company had adopted a new style of pole on the line of its electric road

The pole, as shown in the accompanying illus-

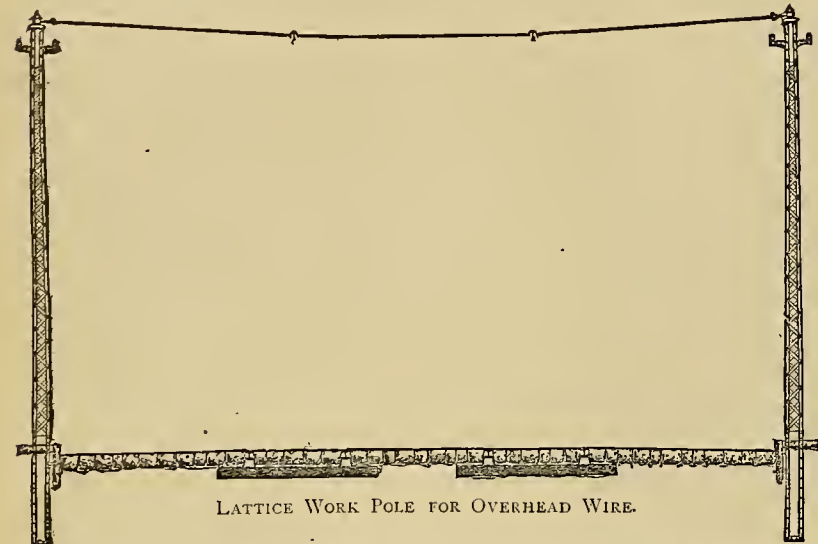

LATTICE WORK POLE FOR OVERHEAD WIRE.

tration, is constructed of channel bars built into tapering columns by rivetted plates, and are provided with an insulated cast iron cap and bracket for carrying supply or other electric wires.

The poles are made entirely of steel, and the peculiar form of construction guarantees the greatest strength to resist the forces to be applied.

They are so designed as to be as nearly as practicable of equal strength throughout, except that the lower portion is made unnecessarily strong by solid plate, to give stability and permanence to the portion below the surface of the ground.

The caps and brackets for attachment and insulation of wires are simple, durable and effective.

They present a light and graceful appearance when erected in the street, and offer practically no resistance to the wind.

**The Pingree Switch.†**

The accompanying illustrations show the general design of the new switch which has recently been placed on the market under the above name.

It is specially adapted for electric and cable roads and places where the traffic is heavy and the wear on the tracks severe. The nature of the material of which it is made and the care

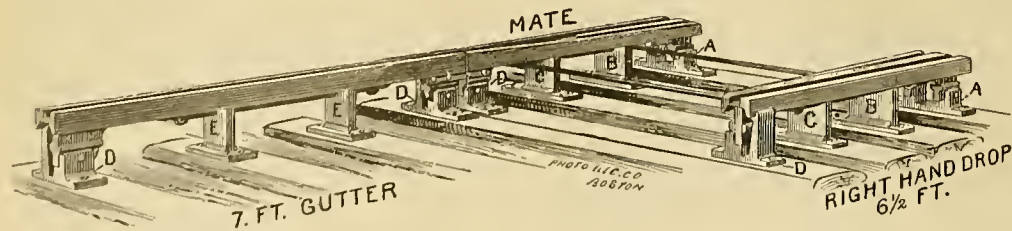

THE PINGREE SWITCH.

taken in its construction, as well as the simplicity and completeness of its design, should recommend it to the attention of all railroad men.

It is cast from gun metal, and is chilled to a depth of about one-half inch at heel and toe, where the heaviest of the wear comes.

The tongue is drawn out, under a hammer, from a solid bar of steel, with no weld. When the tongue is thrown over, it strikes about mid-

way its length a block cast into the bed of the switch, which braces it against the thrust of the wheel and prevents its being bent. The depth of the tread is sufficient to prevent the flange of the wheel from striking this block. A rib is cast on the bottom, and to this, at each end, are

valve chamber in such a manner as to be easily removed when the wear has been extensive enough to cause leakage; but, as this does not readily occur, the renewal of bushing seldom becomes necessary. This style of balanced valve is claimed to be most reliable known in

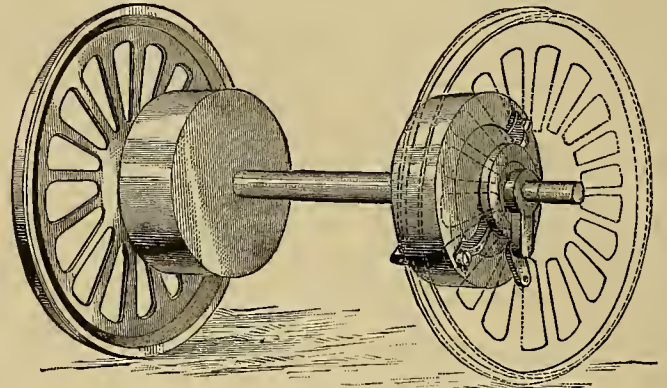

CAR STARTER AND BRAKE.

bolted the fish plates for a tee or girder rail, or the seats for a flat rail. By means of this, it can be fish-plated to any kind of a rail by simply offsetting the fish plates enough to bring the treads of the rail and switch on a level.

mechanics, remaining tight longer and growing more serviceable than valves of any other class.

The automatic drip cock apparatus consists of a valve connected to each steam port, the valves being connected by a cam and lavel, one

movement of which throws the valve wide open or closes it. These valves seldom require to be thrown wide open, as the automatic relief apparatus, which consists of an ingeniously arranged spiral spring holding the valves to their seats, acts automatically to relieve the cylinder of any accumulation of water caused by condensation or priming. As an auxiliary safety arrangement, thin metal caps are provided that will immediately relieve the cylinder of any great amount of water that might, accidentally, accumulate. The automatic cut-off regulator is claimed to be as sensitive as any on the market, and possessing

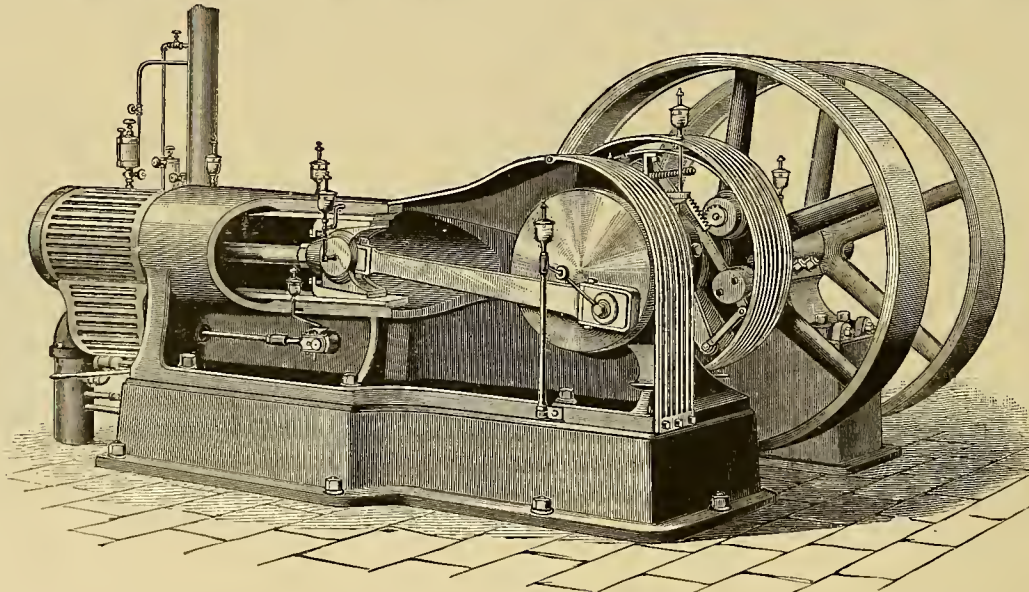

AUTOMATIC HIGH SPEED ENGINE.

The two end chairs are bolted to the switch, and the two centre ones are made movable to conform to the position of the cross ties.

The centre rib serves to strengthen the casting, and also to receive the tie rods which pass through it.

**Automatic High Speed Engine.\***

The engine shown in the accompanying cut is designed especially for electric

features that render it superior to any. The crank shaft is of forged steel of ample size, and the bearings are provided with wearing surface which, the manufacturers declare, render hot bearings an impossibility.

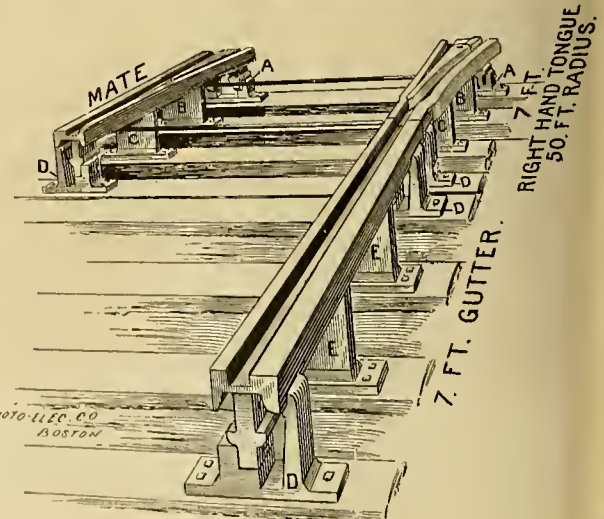

THE PINGREE SWITCH.

lighting purposes, but the peculiar qualities that adapt it to this purpose render it equally efficient for electric railway work, and, in fact, for any purpose to which engines of this class are usually applied. The special features of this engine are the balanced valve, the automatic drip cocks, and, last but not least, its sensitive and efficient shaft regulator. The valve is of the hollow piston type, which works in bushings secured to the

The carriages which have been put in operation recently on the streets of Chicago are doing a splendid business, and appear to be winning the favor of the public at large.

\* Hilton Bridge Construction company, Albany, N. Y.  
† Barber, Stockwell & Co., Cambridgeport, Mass.

\* Taylor Manufacturing Co., Chambersburg, Pa.



**Car Starter and Brake.\***

In this device, the main principle is the use of a coiled spring, one end of which is attached to the car body while the opposite end is attached to the axle, thus causing the spring to coil in stopping, and, by means of throwing the lever forward, the direct opposite result is attained; securing the end formerly attached to the car body to the axle, and the end attached to the axle to the car body.

Contained in both drums of the axle is a coiled spring, one end of which is attached near the rim and the other to a sleeve on the axle, said sleeve running to opposite spring and attached in like manner. In the outside end of the barrels, and securely keyed to the axle, are friction pulleys, which are provided with lugs set in the barrel in opposite recesses; said lugs have arms extending to and loosely connected with a loose friction pulley encircling the axle; said pulley is provided with trip appliances, as shown in the accompanying illustration, the same being attached to a forward lever and designed to engage trip friction at any point of revolution. The faces of the drum are prepared for and supplied with common brake shoes, arranged to apply on either drum alternately, which, when applied to said left drum, will stop rotation of same and allowing right to revolve with axle, thereby causing the springs in either drum to coil until the momentum of the car is stopped. At this point the trip lever is used, which not only releases the right drum from the axle, but also secures it to the frame, thereby giving a forward motion to the axle, which is immediately felt upon the brake being released.

It will be noticed that this device will run equally well when the car is started from either end, thus obviating the necessity of turning cars at the terminus, as also in case of a sudden stop when the brake lever will be thrown forward, thus engaging the brake shoes with right hand drum (the dogs of which stand in direct opposition to those of the left), which, while going in this direction, are stationary, and, consequently, will bring the car to a sudden stop.

**Mill Tramway at Lawrence, Mass.**

Conclusive proof of the fact that electricity can be used to advantage for mill tramways is shown in the accompanying illustrations, engraved from photographs of the installation at the Washington Mills, Lawrence, Mass., which has recently been completed by the Thomson-Houston Motor company. The tramway is used exclusively for carrying coal from the coal pockets to the boiler

to support the trolley wire, which runs in height from twelve feet where all is clear, to eight feet where the truck passes underneath a belt box between two of the mill buildings, the springs on the trolley arm being so adjusted as to maintain an even pressure of the trolley against the conductor, irrespective of its height. The current for the operation of the motor car is supplied from a 110-volt dynamo, which is used for mill

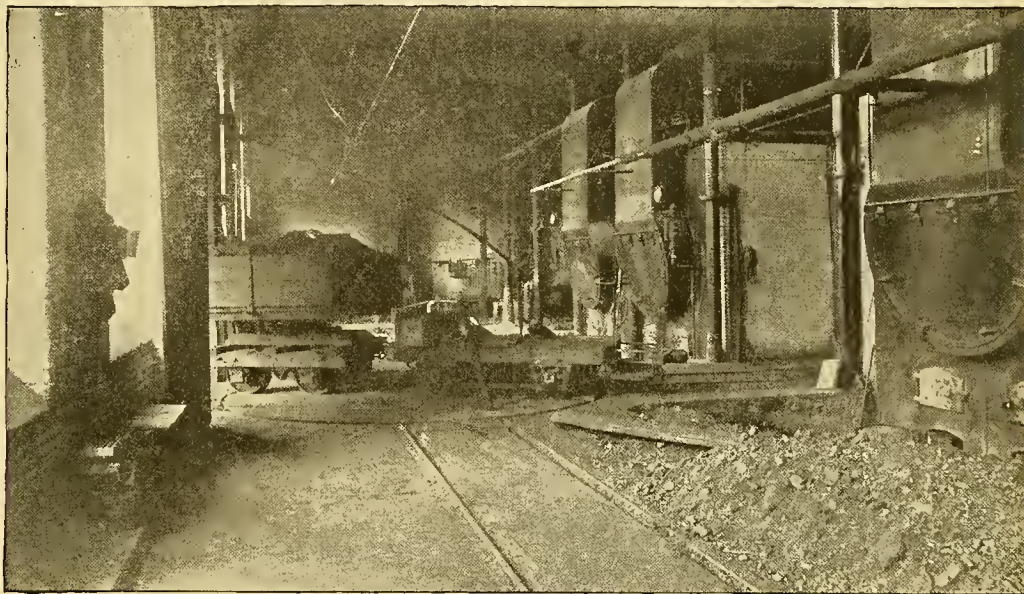

MILL TRAMWAY AT LAWRENCE, MASS.

lighting, the rails and a supplementary ground wire being used for the return circuit.

The car equipment consists of one ordinary dump coal car, and one platform car, provided with one three horse power 110-volt series-wound motor geared to the car axle, and capable of developing sufficient power to haul a load of 5,000 pounds at the rate of six miles an hour. At one end of the car are placed two levers, one for the special type rheostat used for governing the motor, the other for the reversing switch. Both of these as well as the brake handle are under the immediate control of the operator who stands upon the platform in front. The floor of the car is made so that it can be readily removed to allow an easy inspection of the motor and appliances, which, though covered with a thick coating of coal dust at all times, have not failed to operate since the tramway was first put in operation.

**Another Richmond in the Field.**

A company known as the National Electric Construction company has recently been organized in Boston, for the purpose of constructing electric plants for all purposes, for the construction of electric street railways and their equipment, with either the overhead wire or the storage battery system.

Having established intimate business relations

with other companies owning the various systems for the production and marketing of artificial light and power, it is enabled to construct such plants as circumstances render advisable at a very low cost, while its project for combining gas and electric light plants secures great economy in service.

It also proposes to utilize water-power, even for long distances, where the adoption of the same will reduce the cost of producing electricity, whether for lighting or for street railway purposes.

The company occupies a suite of offices at 620 Atlantic avenue, in Boston. The practical business of the company is managed by judicious business men, who have had considerable experience in this business; and an ample force of skilled workmen is at their command. The evident ability and great financial and other facilities of the company have already secured for it many orders for the construction and equipment of lighting and street railroad plants.

Among the prominent stockholders and directors of the company may be mentioned Gen. Benjamin F. Butler, Hon. Lucius M. Child, Andrew Washburn, Geo. W. Chipman, A. H. Sawtell and others. Mr. Geo. H. Drew is general manager, Mr. Fred W. Smith, secretary, and Mr. Geo. A. Beatey, manager of the electrical department.

The "GAZETTE" in welcoming the National Electric Construction company to the electric railway and power field, ventures to predict for it a brilliant career, and the splendid list of names connected with it is guarantee sufficient of immediate success.

**The Social Side of the Electric Railway.\***

By T. C. MARTIN.

A month or two ago we had the pleasure of listening in this hall to a most interesting paper by Mr. S. Dana Greene on the development of electric traction. I had previously promised the secretary of the Society a paper on the same subject, but I felt it would be useless for me to traverse the same ground again. Mr. Greene spoke with authority and not as one of the newspaper scribes, and I was glad to learn from him and to accept most of his conclusions. I recognize the fact, however, that he dealt with the topic mainly on its technical side, as a specialist of experience, and there was still a very important branch of the subject on which a few helpful words might be said—namely the relation of the electric railway to the public and to social conditions generally.

Few of us stop to think of the enormous difference that facilities for travel make in our lives. I do not refer to the opportunities and appliances for long journeys, but to the simple everyday transportation that we calmly accept as a prime condition of existence. It is probably safe to say that every one of us came here to-night, and will go home,

\* Given before the New York Electrical Society, March 12, 1890.



MILL TRAMWAY AT LAWRENCE, MASS.

room, a distance of about 400 feet. The track is level the entire length, and for the most part straight, there being but two curves; a reverse curve just after leaving the coal pockets, and a similar one, where the track enters the boiler house.

In the electrical construction the overhead system has been used, brackets being employed

Mr. Joseph Stanley, president of the Broadway & Newburg Street Railway Co. of Cleveland, O., was fatally injured on Feb. 28, by an accident resulting from his alighting from one of his own cars, when his coat became entangled in the gate of the platform. He was born in Liverpool, Eng., Feb. 28, 1830, and was consequently exactly sixty years old on the day of the accident.

\* W. A. Barker, Chicago.



without depending on our legs to make the trip. But this is altogether modern, and to the generation immediately preceding ours would have seemed as unlikely as that, from a total lack of exercise our legs should become atrophied and own no function of pedestrianism. Yet now that we have enjoyed the advantages that the means of artificial locomotion already give us we want more. The Harlemit does not consider it rapid transit unless he goes from City Hall Square to the rocks and goats above Mount Morris Park in an hour and a half, and his discontent with the steam railway on stilts becomes daily diviner and deeper. The citizen of Brooklyn is not satisfied to be reduced to a despairing calculation as to whether he is after all better off by being jammed and gouged on the bridge than by balancing on one trodden toe upon the old ferry-boats, before he can reach his little vine-clad, mortgaged home at the back of the East wind. And as for the Jerseyman, it is needless to say that of all the ills of his wearisome daily travel, he is able to commute only one. Still, we are infinitely better off in choice of location for our homes than were the people of Manhattan before us, who knew not the elevated railroad, and never gladdened their eyes with the majestic spectacle of the platform of Brooklyn bridge at a quarter to six on a wet March night, with the cable broken down. If you will take the trouble to invite the candid opinion of the "oldest inhabitant" as to the vanished Broadway stages, the early street cars and the ancient ferries, you will learn that we have scored a distinct advance. That is why we all want something better.

This is a barbarous age we live in, but we have a foretaste of the civilization that awaits our descendants. We are beginning to learn that luxury is a relative term. A hundred or even fifty years ago there was no such thing as luxurious travel. Washington came to New York to be installed as president in a manner that a fastidious tramp might despise. De Quincey was willing to give five years of his life for an outside place on a stage-coach that carried down from London through the English counties the news of a great event. We save our five years and our health, and get all the thrill we want by blocking up the sidewalk on Park Row, and reading the newspaper bulletins as they cover one another on the boards like successive waves of emotion, rolling in from the unseen but tangible throbbing distance. We know what the past was. The blizzard of two years ago brought us down to the normal average conditions of semi-savagery in locomotion as it prevailed prior to the introduction of the steam road, conditions that need all the glamor of the romancer to be made even tolerable as a picture to the New Yorker who boards the Pullman special for the South and has had his pleasure in Florida, and returned before the storm that was in progress when he left has gone eastward to discover Europe.

What steam has been to long distance travel in replacing the stage coach and the sail, electricity is in turn to urban travel in replacing the horse car and the cable road. Later in this paper I will indicate the manner in which electricity may sooner or later realize the best and brightest promises made on behalf of the trans-continental steam railroad, but our first thought is as to electrical travel within towns and cities, and the manner in which it affects social relations, by modifying as with the harlequin wand of transformation all the conditions to which we have heretofore been subjected.

In speaking of this great advance of electricity as applied to the comfort and convenience of man, I do not wish to be understood as praising a perfect thing. We are in the early stages of practical electric locomotion. The pioneer work has been done by young men, still among us, much too near their salad days to fall into the reminiscent vein. It is barely three years ago that I had myself the honor of bringing before the American Institute of Electrical Engineers the first statistics published on American electrical railways, when I seized with a brazen audacity upon every bit of a track that could possibly bear inclusion as a road. I would be understood rather as appearing in advocacy of an improvement, in many respects crude, but that is not yet appreciated even as it stands. We of the electrical industry have a great duty in this respect, of preaching the advantages of electric locomotion, in season and out of season; and by our persistency we can help the art along. The phrase that good wine needs no bush was not coined by an American advertiser, and the idea that electricity will make its own way is not justified by the history of any great invention that has yet subserved the needs of mankind. Electric locomotion is, however, ready for adoption at an opportune moment. It offers itself at a time when every thing else that has been tried for urban travel has revealed objections and disadvantages, the more keenly realized because of our higher conceptions of what such travel may be. It is a singular principle that as a system or device reaches perfection something comes forward to supersede it. The horse coach was at its height of speed and comfort when the steam engine challenged it. The white-sailed China clipper was never swifter than when it lowered its flag to the conquering steam ship. And so to day, the horse, the cable and the steam locomotive have shown the utmost that they can do, just as the electric motor rolls to the front and takes the stage, as the means best suited to the peculiar requirements of passenger traffic in modern towns and cities. I do not say that it will banish these competitors from the scene, but I do maintain that its superiority will quickly gain it the decided preference. I am always suspicious of an invention or improvement that is going to knock out every thing else, like a charge of dynamite. History is against any such phenomenon. What we do see is a limitation of the antecedent methods and appliances to the sphere within which they are most useful and economical. The old is restricted to its proper place and function as by a ring of fire; the new goes on making its own kingdom until at last its boundaries of achievement are also determined. Thus, as Tennyson puts it, "God fulfills himself in many ways, lest one good custom should corrupt the world."

The first of the social considerations to which I would

direct notice is the effect on the public of the adoption of electricity as a motive power for street railways. The struggle for supremacy in urban passenger work has already narrowed down strictly to the horse, the cable and the electric motor. As everybody knows, steam motors are completely out of favor for use within city limits. Their glorious record of half a century in long distance travel does not deceive any one dwelling in a city as to the insuperable defects and nuisances of noise, smell, smoke, dust, steam escape, oil drippings, etc., which may more readily be tolerated, remotely, in the open country. Perhaps I am wrong, but I believe we shall not see any more steam roads in New York, and that imposing as are the statistics of the Manhattan elevated system to-day, they will be eclipsed in a very few years by those of the newer form of electric locomotion. And may not the same be said as to the horse? There are now close upon 15,000 horses engaged in hauling street cars around this city. It is high time that every one of these was dispensed with, as well for its own sake as for that of the city, whose air it assists in polluting and whose population it aids in driving into exile. Allowing an average space of 40 square feet to each horse, or a stall 9 feet by 4½ feet, we find that in stall space alone those 15,000 horses occupy 600,000 square feet of floor in their stables. These horses are required to operate some 2,400 cars, an average of about seven to the car if every car were in commission at once, which is not at all the case. But even if nearly all the cars were wanted, an average of 10 horse power each would be ample in the central station of an electrical plant, bringing us to a liberal allowance of 25,000 h. p. But here comes in the remarkable though not unfamiliar fact that a steam plant will go into much less space than an animal power plant of equal capacity. Mr. C. J. Field, who is known to many of you as a constructing and mechanical engineer, informs me that his recent practice shows that a generating electrical plant for 20,000 horse power to operate all the street cars of this city could easily be placed in a building 100 x 150. The engines and the dynamos would be placed on the first floor, and the boilers on the second floor. The generators in such a plant would be multipolar, 500 h. p. each, directly connected to the engines, and each engine would be of a vertical triple expansion type, of 500 h. p. each. This gives only one and one half square feet to the horsepower, and we may offset the space for feed, etc., by that for coal, etc. I have tested these figures by those of recent electric light stations in actual operation, and they are found to be very fair and reasonable. It might be objected that all the power would not be bunched in this way; but even with half a dozen generating stations of 2,000 h. p. there would only be an increase in space required of about ten per cent. From this remarkable but strictly proper comparison, we can form an idea as to the economy of real estate, bearing in mind also the fact that horse car stables are generally wooden or brick sheds, only one or two stories in height, while an electrical plant may be run up as high as an apartment house or an office building, just as ornate without, just as clean within.

Hence there can be no mistake in the statement that electricity is a direct boon to the urban population that clings to the city, loves the city life, and that if crowded out from it into the country suffers all the pangs of banishment. Indirectly, too, it is a further boon because with horses a great portion of the district surrounding the car stables is also spoiled for human habitation. The whole region within what I would define as "the area of smell" is unsavory and unhealthy the year through, and the consequence is that while the taxing and renting value of it is lessened, the death rate is run up. "Do not insult a respectable animal who has come from the country to do his share of the work of the world," says one authority, "and has brought with him the memory of the sweet hills and skies at least, by immuring him in one of those cramped rickety, rotten, slovenly, damp dungeons, where a dumb beast would lose his self respect and his courage, beneath an oppressive weight of miasma, and hideous, gloomy, nasty confusion." And so say all of us, and all of us are glad to note a vast improvement in this respect. The stables are better ventilated now as a rule, but the trouble is just there. If they were not so well ventilated the neighborhood would be sweeter, and would be fitter for human beings to live in. The poor die quicker that the horses may suffer longer.

An objection I may anticipate is that after all, such large generating plants would not be desirable with their huge smoke stacks, their discharge of gases, etc., upon the atmosphere, their receipt of coal and their removal of ashes. I would reply that it is by no means necessary for such plants to be, as the stables must be, right upon the main lines of travel. They would by decided preference be located near the water's edge, out of the way. Moreover the stack would be, as they are to day in large electric light plants, high enough to carry off all smoke or smell far beyond perception. Perhaps the familiar smoke stack is not an aesthetic object, but it can be made so. There are steeples in this town that on the score of their beauty are not fit to compare with smoke stacks near them.

Much that I have said under this head with respect to electricity applies to the cable. That system has been an immense advance in street car travel, and is destined to many years of usefulness yet. It is worthy of much praise, but it will not hold its own with electricity, simply because it is deficient in some things that electricity possesses to a preëminent degree. It has been a John the Baptist for electricity. It is not only enormously costly in its first installation, but has the disadvantage of being a unit. The whole of the road and all its power hangs by that one cable. If the cable be duplicated in the conduit, the expense is again so much the heavier, while the criticism as to risk still stands. Moreover, a cable car can not go backward at its driver's will. Onward it must go, Mazepa-like, strapped down to its carrier, no matter what unfortunate contingency impend, or what obstacle lies in its path. It can not greatly vary its own speed. An electric car is so manageable that it will reverse in its own length or less.

But the greatest trouble of all with the cable is that it is always the one thing, while there are very few towns or cities that are alike in offering just the rigid Procrustean conditions it meets. There are about 50 cities in the United States with a population of over 50,000, but there are between 700 and 800 street railway companies, if not more; so that even if all the places in the first category could justify the heavy expenditure on a cable system, there are hundreds of others unable to do so. We need not wonder, then, that at their last convention in Minneapolis, the street railway men gave electricity such a hearty welcome, adopting the enthusiastic if not elegant language of a committee report which said that it "filled the bill to perfection." Nor need we wonder that the street railway company in Minneapolis has just thrown aside an unused cable plant that cost \$400,000, and is putting in electric cars and over 100 miles of electric road.

Why does electricity "fill the bill," and in a manner that interests the public? Well, for the reasons given already and for others. It is above all things flexible, plastic, protean. It can be applied in half a dozen different ways, and be absolutely safe for human life in any and all of them. The street railway may be equipped with an overhead system for supplying the current to the motors, and to that system, well built, with trim ornamental poles, lines well run and guarded, little or no objection can be offered. The air is God's own insulation; we know none better, none so cheap, and a wire is well insulated up aloft. The Bostonians, who are people setting no small store by their refined, acute and cultivated taste, have adopted poles and wires in preference to the hideously ugly lattice-work tunnels we have in New York to hold up our elevated roads, and I admire them for it. It is possible that Boston may have an elevated road, but if so it will be a handsome electric one. Or, if the overhead wire be objected to, as it may, there is the conduit system, which is fully able to give a good account of itself if well put in and plenty of money be spent on it. It is true that the wires are not exposed in the conduit system, but otherwise there is not much operative difference between it and the overhead method. There may be difficulties in heavy, wet or snowy weather, but we shall see them all overcome. Or should this or its modifications again be found fault with, there is the ideal storage battery system, where each car starts out "on its own hook," an independent, self-contained unit. I don't exactly know why we call it the "ideal system." It is either within reach or beyond. If within reach, it is not "ideal," but ought, speaking from the public standpoint, to be adopted wherever there is actual need for it. It may be a trifle expensive, but that is certainly not one reason more why the public should do without it. It may be somewhat difficult to put and keep in order. "Coaches, Sammy," said the elder Weller, sententiously, to his son, "coaches is like guns—they require to be loaded with werry great care afore they go off," and that is about the case with the storage battery cars. But they do go off, and we know from the approval that they have met with that they do hit the mark of popular approval. And that is one of the main things I am talking about to night.

It is in one or other of these systems or modifications of them that electricity will become familiar to the public of this country in street railway work. It will, I think be chiefly for a long time to come, the overhead system, which is not costly to put up, is not expensive to maintain, can be operated economically at about half the running charges of animal power, and fully answers the requirements of the vast majority of our thriving, intelligent centres of trade and manufacture. All these methods are safe, and none of us ever heard, or expects to hear, that the currents of 500 volts they have employed has taken a single human life. The motor cars can not "explode," the daily papers to the contrary notwithstanding. They scatter no dust or ashes; they do not litter the streets with offensive refuse, but rather ozonize the air; they are pleasant to ride in and they do not damage the paving. They require good tracks for their best operation, and naturally make their worst showing on the automatic mud sprinklers that so begutter the roadways in this city. But the roadbed between the tracks they never touch. It might as well be a continuous plot of flowers. In the outskirts of Boston some of the electric cars whose aerial wires run hidden between the overarching trees, have their tracks laid down on a narrow green lawn for three or four miles; and at a remove of but a few feet it seems to the spectator as though the cars were gracefully skimming over the smooth grass, in effortless flight, like jow-darting, even-poised swallows.

I have just spoken of the outskirts of Boston, and this brings me to another important point wherein electric cars are an element making for the public good. They help a man to get farther away from his business, and yet bring him nearer to it. "Rapid transit" by this means is no longer a deceiving phrase or the proud monopoly of one or two big cities. The smallest city in the country is at once given a command it never had before over the territory around it. The smallest storekeeper or the humblest clerk can revel in the sweets of rural life if he wish. His electric car, running at 15 or 20 miles an hour, will give him more of home life—a few golden minutes with the children in the morning, an earlier return to the wife at nightfall. The whole social atmosphere of the place is vivified, and the social bonds are knit closer, as they always must inevitably be where the facilities of travel are increased and the opportunities of intercourse are multiplied.

Nor is this all. Rapid transit of this nature opens up a number of districts that before were practically inaccessible for residential purposes. There are few of us who care to practice the ancient form of dissipation known as early rising, agreeing rather with Charles Lamb in the idea that to rise with the lark or to go to bed with the sheep is a popular fallacy. There are still fewer of us who even for the sake of rural delights care to isolate and immure ourselves in remote suburbs reached with difficulty. In vacation time, it is true, we often seek the loneliness of the woods, or the solitude of the mountain, that we may commune with Nature and hear the still small voice of our better



self; but when we are doing the world's work fifty weeks in the year, we want to be handily situated for reaching our desk or bench. If a man lives in the city, he pays a high rent and takes Irish views of the landlord question. If he lives far out, and wastes his time in travel, he is in hearty sympathy with the eight-hour movement. I look upon electric roads, therefore, as likely to prove a beneficial agency in the more equal distribution of a happier population around any centre, thus increasing the return on outlying property, while, by the encouragement of retail trade, enhancing the profit of the area lying within the region thereafter more legitimately restricted to business occupancy. I have watched with much interest the manner in which electric roads have already thus developed suburban areas. Booms are not a particularly healthy feature of progress, but they may be, and not infrequently are, genuine and real; and I know nothing more likely to bring on a real estate boom of the best character with permanent results than the installation of a well-managed electric road, enabling a man to leave his work at six o'clock and be sitting down to his supper seven or ten miles out, if he wish, under his own roof tree at 6:30.

Having thus discussed the effect of electric roads on the community and on the individual citizen, I will add a word as to their effect on the wonderful impersonal entity "capital." If all that I have said be true as to the general benefits, it follows that the wealth and ease of the community are materially increased; but what I refer to now, is not the direct enhancement of values, so hard to trace out, though so palpable, but the stimulus given to saving habits by the better opportunities of investment. Careful analysis of the working of electric roads goes to prove that when operated with skill and discretion, they are 50 per cent less expensive to run than horse railroads are. What does this mean? One thing it means is that many roads can be built that would be out of the question with horses. Another is that roads not paying can be placed on a dividend basis. In 1888, out of nineteen horse roads reporting in New York City, ten showed a deficiency. Last year their net earnings were much better, but it is evident that a horse road is not always a mine of wealth, though it may be of fertilisers. A third point is the establishing of a new class of investments of a solid, enduring nature. It is within everybody's knowledge that the accumulation of capital tends constantly to the reduction of interest to a minimum. There was a time when the long stocking and the iron chest were the common banker for the savings of the timid, and the capital that was bold earned the double reward of its bravery and scarcity. As Walter Bagehot, the economist, has remarked, the English people have always wanted to put their money into something that will yield five per cent; and this is undoubtedly one reason why English capital, free and fluent, is so much a power in the finance of the world, and why so much comes this way. As Mr. Bagehot says: "In most countries, most men are content to forego interest; but in more advanced countries at some times there are more savings seeking investment than there are known investments for." It is thus in America, so far as "safe" investments are concerned, and by safe I mean such as do not require the active care and ceaseless thought of the capitalist, but may be held by trustees, widows, hospitals, universities, savings banks and the like. The competition of capital for the best class of government bonds, municipal bonds, railroad stocks, etc., has reduced the earnings on these to a very low figure, whether in America or England or Germany; and the result is that we see to-day, as never before, the planning of enormous trusts and gigantic industrial enterprises, which represent in no small degree the endeavor of capital, or savings, still to enjoy its wonted income, but in newer fields. Now I look upon the street railway business of the country, under the regime of electricity, as offering one of the best opportunities for local capital, and for what may be called the organization of local savings, which might otherwise lie around in napkins, like the unjust steward's talent, and be of no use to anybody. The capital in street railways in America to day reaches from \$175,000,000 to \$200,000,000. If the statement I have made as to the superior economy of electrical power be true, how much greater becomes the earning capacity of this investment and how much greater are the attractions held out to construct the hundreds of new roads that are still wanted and will be called for as our towns and cities grow. Of course, I am aware that it may be said that this showing might lead to a demand for lower fares. It might, but the public is intelligent enough to know that other things are more necessary, such as better cars, with better heat and better light; improved tracks, faster running time and shorter headway; so that the fifteen hundred million passengers on street railroads every year may travel in all safety and comfort. Street railroads are peculiarly suitable as a field for local investment. Their operation can be watched all the time. They run under a man's eye when he is on the street or past his window when he is home. He knows something of their officials; he can influence the domestic legislation they are subject to; he can assist in more ways than one to swell their earnings.

The next important point to which I would direct your attention is the effect that the electric railway has upon the employees of the service. It can not be denied that the introduction of electricity in this respect marks a decided advance in the social condition and aptitudes of a large body of men. I have never yet met with anybody or anything that could place the work of a horse car driver in a favorable light. One certainly could not fairly expect a man who spends the day with his nose at the tail of a car horse to realize a very high ideal of life and duty, especially when the whole of his work is done under conditions exhausting alike to temper and physique. It is outdoor exposure the whole time, whether in summer heat or winter blast. Half the time it is an exercise of sheer brute strength, and no car driver believes in his heart that a horse power is, as a fact only 33,000 foot pounds a minute. His aching wrists and dislocated shoulders tell him that Watt was far below the mark even in putting it at that fig-

ure. And then, the worry of the street traffic! We have all of us noticed the conscientious persistence with which draymen and coachmen will keep on the car tracks in front of a car. An investigation made two or three years ago in Chicago showed that at one point in the streets there 97.6 of the street traffic sought the railroad, while at another it was 87½, and at a third, 90 per cent. Against such odds the driver with his restless or apathetic team has to make his way and keep to the running schedule; fighting all the time with the fear of an accident either to his car or to some hapless foot passenger.

With an electric car, the matter is not one of muscle and brawn, but of average intelligence and ordinary readiness of decision. A better class of men are wanted and forth coming, or the same men are relieved from physical wear and tear, and thereafter can earn their bread in the sweat of their brow and not that of their body. A woman might easily run an electric car. The motor-man gets instantaneously by the turn of a switch the exact degree of power that he wants; he can apply his brakes readily; and if he needs to run backward uphill he can do so, sitting down at his switch. It is not necessary to expose him to the weather. His fears as to running people down are materially lessened by the gain in control of the car and by the further fact that an electric car takes up only half the space on the street that a horse car and its team do. The work is not less safe than cleanly. You may remember that when steam roads were started in South Carolina, one of the negro drivers tied down the safety valve and then sat on it. As a result, cotton bales were placed between the locomotive and the coaches to protect the passengers in case of explosion. The new driver was, however, still on the wrong side of the bales. In electric cars both driver and passengers are free from harm. John Bright once said that the safest place on earth was a first class carriage in an express train but to-day it may be fairly affirmed that no vehicle can compare as to freedom from danger with the electric street car.

A feature of this refinement of the work is that it must necessarily be attended by better pay for the higher intelligence and skill. Mere brute strength does not command good wages nowadays, except in a prize fighter and the further we get away from animal conditions the better do we find the status of the individual or the occupation to be. The remarks made above as regards the drivers apply equally to the staff at the generating plant. People sometimes wonder why there are so many hostlers around car stables but when you remember that well kept car horses work only two hours and a quarter daily, you will see that they need a good many attendants at the stables during the other twenty odd hours. In place of these grooms and hostlers you have, with an electric plant, a skilled force of steam engineers and mechanics, each trained for the special function which the principle of the division of labor has shown him to be best qualified for.

And here let me inject the pertinent remark, that this new and successful development of electricity is one reason more why the mechanical engineer and steam engineer should master electrical principles and practice, whether for the higher walks of his profession or for the humbler duties of running a plant. The coming of electricity, and its application to light and power has afforded a grand stimulus to steam engineering in every department and may not improperly be claimed to have created the modern high speed engines. Sir William Thomson has said that the electrical engineer is nine-tenths a mechanical engineer. To this I will add a corollary, and say that the mechanical engineer may be a master in these new electrical fields if he will only add the one tenth to his education. The time is at hand when the mechanical engineer will not be considered worthy of his name or his calling unless he is also an electrical engineer, as familiar with Ohm's law for instance, as he is with Carnot's or Mariotti's.

Incidentally through this paper I have referred to the effect of the electric railroad upon horses. It has, indeed, been most gratifying to see how readily the electric railroad has rallied to the support of the Humane Society. It is a Humane Society itself. Whether he wished it or not, the electrical engineer in this instance is conferring a great boon on the horse. We sometimes do the greatest good, as we do often the greatest evil, unconsciously rather than of set purpose; and so, here, the inventors of the modern electric motor and the electric car have released the horse from one of the most painful and exhausting services that it was ever put to. Investigations over a long period have shown that with the pavement dry a horse would meet with an accident in every 78 miles of travel on granite; in every 163 miles with the pavement damp, and every 537 with the pavement thoroughly wet. Unfortunately for the horse, though happily for the rest of us, the first two conditions generally prevail on our streets; and hence the horse has a poor outlook as to accidents. But it is not the accident the horse has so much to dread, after all, as the constant strain and the pull of a heavy load from its dead rest every few hundred yards. It is generally admitted by street railway men that car horses fail because of this feature of their work, and that it helps to cut down their railroad life and utility to the average of from three to five years. If you want to see these conditions at their worst, take Broadway, once our pride, now one of the most overrated thoroughfares in Christendom. The pavement is abominable, and the horses, like the foot passengers, can be seen struggling for a grip on the uneven, slippery stones, all the way from one end of it to the other. The traffic on the street is so great that I have noted full cars making a dozen halts and starts from dead rests between Chambers and Barclay streets, two blocks. It does not require an expert to foresee the effect of such wear and tear on animals. In Cincinnati, recently, on installing an electric equipment a street railway company advertised its horses for sale for family and carriage purposes. I have not observed any such advertisements in New York city. The street railway managers are more modest or more truthful here than they are on the banks of the Ohio. The only persons likely to regret seriously the departure of the street car horses from

this city would be the horse dealers and feed supply houses—and possibly the street cleaning contractors, though they get their pay anyhow.

I might point out that as a further offset to this displacement of a certain amount of labor in an elementary form, whether that of the horse or the human being in charge of him, we have the stimulus given to a higher class of labor, not only in the station engineer and motor car driver, but in the electrical expert and inventor. Society benefits greatly by this, just as it does by the superior skill and efficiency implied in the maintenance of such a system as that of the Pennsylvania Railroad company. The running of express trains and fast steamships demands the exertion of the best qualities of a man as well in the conception of ideas of improvement as in the details of solid construction and vigilant management. Here, therefore, we strike at once into a new field of design and invention, one that promises to be as large and fruitful as any other known to the application of electricity. There have already been several hundred patents taken out on the special subject of electric railways and the whole air is alive with rumors of the ideas and inventions assuming shape. In a year or two it will be a wise motor that knows its own father. Each new step is a prophecy of a dozen more. Each new patent is a "father of its country" a germ of endless fertility. We begin to learn our resources. "Is there any load that water can not lift?" asked Emerson. "If there be try steam; or if not that, try electricity. Is there any exhausting of these means?"

Now and then I hear the objection that people would be the quicker to adopt electric locomotion if it were not so beset and made costlier by patents. This is not true and I have no patience with the spirit that begrudges the inventor his reward. Why do we use the great inventions? Simply and solely because they effect an economy for us in some way or other chiefly in time or money. If they did not, we should care little about them, and the inventive geniuses of the day would be mere common clay to us. But, on the contrary, the inventor is revered and admired, and is encouraged by the wealth and fame he can earn. Occasionally one hears the expression of an idea that the inventor is wanting in public spirit and devotion to science because he takes out patents and does not invite the world to revel in the riches he reveals while he is content to starve over a crust in a garret. A few weeks ago Mr. Edison told me that he had found one of his greatest intellectual pleasures in reading "Evangeline." But why should it be less public spirited for Edison to secure a patent on his phonograph than for Longfellow to obtain a copyright on his poetry? Why should not Bell have a patent on the telephone when Victor Hugo protects his "Notre Dame"? Is it not as right for George Westinghouse to derive a princely income from his life-saving air brake as for Gilbert and Sullivan from their comic operas? Shall not Elihu Thomson derive some income from his new art of electric welding as well as Bronson Howard from his "Shenandoah"? It is time that the ideas on this subject were set in the right perspective. Our inventors enjoy the benefits of the patent system because, like the novelists, the poets, the musicians and the artists, they are public benefactors. They promote the public welfare, add to the public comfort, increase the public wealth. The field of electric locomotion will be but one more opportunity to demonstrate this truth. There is no patent on the horse, but the patented electric motor can beat him on every point every day in the week.

Such, then, are some of the reflections to which our subject invites us at this early stage of its development, and there is but one other point to which after this section I shall refer in closing. Before I leave the electric street railway, I would again say, as I said at the outset, that I am not presenting this latest application of electricity as perfect. It is not; on the contrary, it is in development and improvement under our very eyes. It is endeavoring to harmonize with its environments. The questions and problems that it opens up are very much like the concentric shells of the Chinese ivory puzzle balls; and we have not yet reached their core. It has one or two family quarrels on hand. The telephone is hardly yet on speaking terms with it. But we know fairly well where the solution of each difficulty lies, and we are on the way to it. Nor am I in any sense an apologist for the shortcomings of our pioneer work. Electric railroad men have made mistakes, are making them now. That can not be helped. Heaven save us from the men who can not make mistakes! They will never learn! The conditions in electricity as an industry change with lightning rapidity. A Russian general once remarked of the political situation in Central Asia that it changed every minute; and so it is in regard to the onrush and uplift of electrical discovery and enterprise. This very fact explains why much of the earlier electric railway work has been of an unfinished, unempt kind. Mr. Charles Francis Adams, some years ago, in his interesting little work on railroads, said: "It is a matter of curious observation that almost uniformly those early railroad builders made grave blunders whenever they tried to do their work peculiarly well; they almost invariably had afterwards to undo it." This is not an excuse, however, for slovenly work. It is better to make blunders trying to do well than in lazily neglecting one's duty; and though it hurts a man who built for eternity to see his work ripped out in five years, he has the serene, sustaining consciousness of right effort and honorable performance. The electric street railway will the sooner achieve its social destiny if the engineering done upon it be the highest and best that the art at each instant will allow.

The topic I have reserved for brief final mention is that of electrical long distance travel. This is the department of the subject in which imagination has not yet sobered down into invention. Our fancy still plays around the possibilities, and so far from realizing the social side of teletravel, people have not yet awakened generally to the idea that it has any serious practical side at all. Our patriarchal poet Whittier expressed his surprise a month or two ago in his "Burning Driftwood," when he wrote;



"Far more than all I dared to dream,  
Unthought before my door I see;  
On wings of fire and steeds of steam  
The world's great wonders come to me."

The steeds of steam are now an old, familiar story; but the mechanical Jay Eye-Sees of the coming day bid fair to be those with "wings of fire;" and then our speed may be something more nearly approximating that of light. It is amusing, however, to see how quickly our generation has become accustomed to teletravel. Did not the Royal College of Bavarian Doctors seek to forbid railway travel because it would induce *delirium furiosum* among the passengers, and drive the spectators crazy? Did not an English quarterly say: "We would as soon expect the people of Woolwich to suffer themselves to be fired from one of Congreve's rockets as to trust themselves to the mercy of a machine going at the rate of twelve miles per hour?" And did not our own General Webb in 1835, after a railroad journey with ladies from Boston to Providence, exclaim in horror: "To restore herself to her caste, let a lady move in select company at five miles an hour, and take her meals in comfort at a decent inn." Such alarming and conservative extracts have a familiar sound, perhaps, but I can assure you that they are positively of the ancient date mentioned and not extracts from recent New York newspapers. The fact remains that to-day we have ceased to regard a speed of 60 miles an hour in railway travel as extraordinary, and are casting about for the means with which to attain a higher rate even than 75 miles, of which record was made in 1886 on a short run. This acceleration is, it appears probable, to be found best, or only, in the use of electricity, for the reason that the electric motor may drive directly on the axles, that it need not offer much resistance to the air, or smash the track, and that it does not have to carry its own supply of fuel and water. There are men in this audience who have seen such an electric locomotive making with ease 120 miles an hour, and who propose to propel it at 180 miles an hour. If these things be so—as they are—we know that with electric teletravel, the public will have to accustom itself to strange new conditions, exceeding in scope and power those of the last fifty years. The change will come in our time, and the present telegraphic and telephonic facilities are but an education for it. When we can talk instantaneously with friends in Boston or Philadelphia over a wire, we resent the inadequacy of the means of fast and far locomotion that should enable us to meet them face to face if we wish to do so. When we see electric cars in our streets traveling easily at 15 and 20 miles an hour, and know that on a clear, unbroken straightaway track we could go from New York to Philadelphia or Boston with the same agency and kindred apparatus, in about an hour, American ingenuity and enterprise will not rest until the thing is done. That will be the first stage in the next evolution of travel.

At the present time electric street railroads are running or building in nearly 150 of our towns and cities, with some 2,000 cars on about 1,200 miles of track. So far as urban traffic is concerned, the new departure has been made. Electric locomotion is with us, an assured fact, the most civilized form of travel, as the electric light is of illumination and the telegraph or telephone is of communication. Already over 100,000,000 nickel ballots are being cast yearly in its favor, and the welcome to it is universal. In the Northwest that brand-new cable plant costing \$400,000 has just been thrown aside to make room for it. In the South it is saluted with the exclamation of the delighted darkey, "First dey freed de negro, and now dey freed de mule." In New York we are waiting on Providence and the Aldermen, but we shall not be satisfied till this city is abreast of other progressive communities in the adoption of that which has given, in so short a time, so many proofs of its ability to promote in every respect the highest social welfare of the citizen.

**Double Motor Truck.**

The accompanying illustration shows the new improved Thomson-Houston double motor truck which has many new points of excellence. As can be seen from the cut, it is very substantially and thoroughly made, and so arranged that every part is easy of access, and especial attention has been paid in its design and construction to facilitate the easy removal of the motor armature, and the wheels, and, in fact, all the parts which are subject to wear, and require replacing.

**New Style in Poles.**

The tendency among electric railway companies seems to be toward making all parts of their apparatus as handsome and durable as possible, especially in the direction of the overhead line.

This portion of a street railway equipment is now the object of a great deal of study, and the new roads which have been installed show that

a great deal of care and skill has been spent in the design of the overhead system.

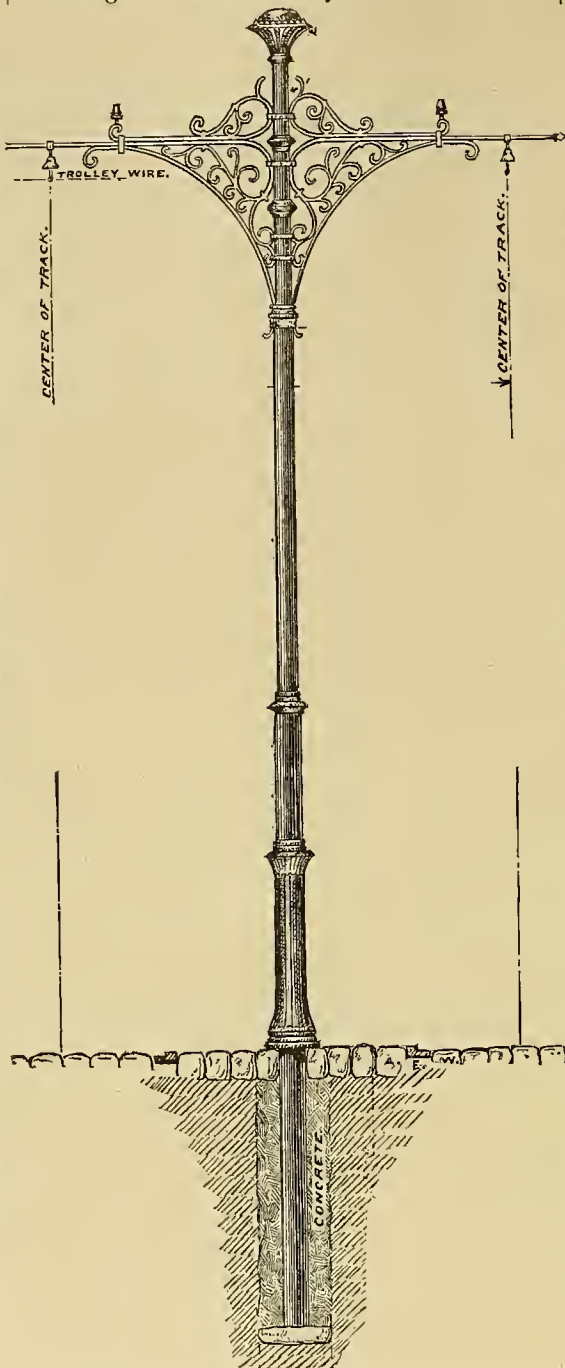

The pole we show is of quite ornamental design. The trolley wires are carried at the end of bracket over the center of the track, and main current

**Compound Engine for Electric Service.\***

In this engine one of the most important features is the ready access to the valves. (See opposite page.)

The high pressure cylinder is attached to the frame, and the arrangement is such that the piston and rear head of the high pressure cylinder, together with the front head of the low pressure cylinder, can all be drawn back together through the low pressure cylinder. This construction permits both pistons to be taken out without disconnecting the cylinders.

The valves are all of the D slide type. The high pressure valve works between the valve seat and a pressure plate, and is pressureless. As this valve and the pressure plate have inclined surfaces in contact, it is self-adjusting and always tight. By reason of the valve being pressureless, the extreme high steam pressures so desirable in compound engines are permissible.

The high and low pressure valves are actuated by independent eccentrics. That moving the high pressure valve is controlled by the governor, while that of the low pressure is fixed. The governor is on of the ordinary types of the shaft governor. The engine is very heavy, and is admirable adapted for electric railway work, and especially in cases where severe duty is demanded.

**Findlay, O., Street Railway.**

GEO. B. KERPER'S UNIQUE REGULATIONS.

"I was a conductor on the first line of street cars that was run into Findlay, O.," said Uncle Silas Bowersox, "and some of my experiences in that capacity have never got into print. You see, Findlay is a natural gas town that sprung up in a night, as it were, and the agricultural regions roundabout were sort of dazed. The farmers used to come in and gaze with wonder on the bustling young town.

"The street cars were a source of great curiosity to the natives. They were afraid of them at first, but at last they began to cotton to them. In fact they soon found them so useful in the delivery of farm products about town that we were obliged to print and hang up in the cars a set of rules such as no other street car company ever had before or since, I think. I called at the superintendent's residence one evening, and after explaining the situation to him we formulated the following rules which we displayed conspicuously on all our cars:

**"NOTICE TO PASSENGERS.**

"Passengers must not bring live stock on the cars, except pigs, sheep, lambs, calves, geese and chickens in crates.

"Not more than ten bushels of vegetables allowed to each passenger.

"Pumpkins not taken unless passengers carry the same on their laps.

"For each telegraph-pole and bundle of fruit-trees five cents extra will be charged.

"Household goods, such as furniture, beddings, stoves and kitchen utensils, will not be carried at all. We are no van company."

"There were more to the same effect. It was a long time before we could get the folks out that way to observe these simple rules, and almost every trip you could see a conductor holding his car while he got out and read the rules to some old farmer who had a calf he

wanted to bring aboard."

We understand that another electric company will at once enter the street railway field.

\* B. W. Payne & Sons, Elmira, N. Y.

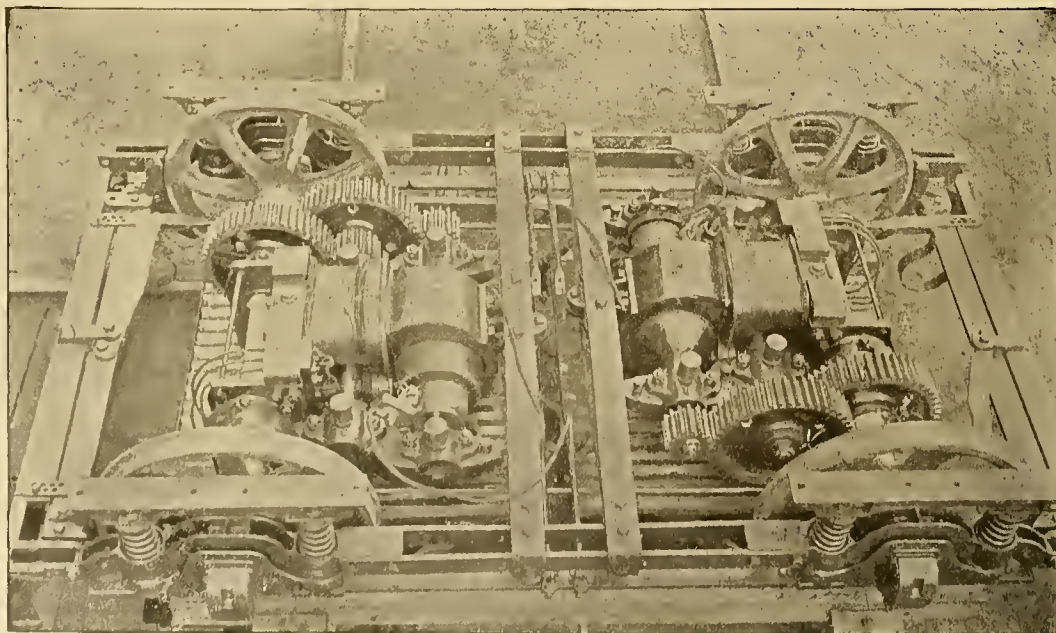

DOUBLE MOTOR TRUCK.

wires nearer the pole on the insulators shown in the view. The pole, in order to secure stability, is set in concrete to a considerable depth, this being found to be the most reliable and durable method of pole erection.



**Judge Coxe's Brush-Julien Secondary Battery Decision.**

UNITED STATES CIRCUIT COURT, SOUTHERN DISTRICT OF NEW YORK.

*The Brush Electric Company vs. The Julien Electric Company, et al. In equity.*

COXE, J.  
This is an equity action for the infringement of four letters patent, granted to Charles F. Brush, for improvements in secondary batteries, and now owned by the complainant. These patents are numbered and dated as follows:

Nos. 337,298 and 337,299, were applied for June 13, 1881, and were granted March 2, 1886. No. 260,654 was applied for June 13, 1881, and was granted July 4, 1882. No. 266,090 was applied for June 9, 1881, and was granted October 17, 1882.

The first of these, No. 337,298, which is distinguished as Case I. relates to secondary batteries, and consists in a plate or support provided with a mechanically applied coating of absorptive substance to be transformed into an active coating. Also, in a plate or support provided with a mechanically applied coating of granulated, spongy, or porous metallic lead. It further consists in the method of constructing plates for secondary batteries, consisting in mechanically coating lead, or other suitable plates, with an absorptive substance adapted to be transformed into an active coating. The drawings attached to the specification represent the supports in various forms. They show plain, studded, honey-combed, corrugated and ribbed plates; plates with angular corrugations, arranged singly or in pairs, and plates with slots or perforations extending through the plates. The active material consists of granular, porous or spongy lead, which is held in position upon the plain plate of lead by a sheet of heavy paper, cardboard, cloth or felt, which may be secured to the plates by rivets, ties, or binding strips of wood or metal. The paper or felt may be dispensed with, and the spongy lead held in position on both sides of the support by subjecting it to pressure, hydraulic or otherwise. In the corrugated, grooved, ribbed, perforated, studded or cellular plates the spongy lead may be held in the grooves, cells, or cavities by paper or felt, or it may be rammed or pressed into them.

The specification states that "when a pair of plates are associated together to form a secondary battery, and immersed in dilute sulphuric acid and charged by the passage of an electric current in the usual manner, one of the plates absorbs a large quantity of hydrogen while the other plate has its spongy or granular portion peroxidized, and thus forms the oxygen element in the battery."

The claims alleged to be infringed are the first, fifth, eighth, tenth and eleventh. They are as follows:

"1. A suitable plate or support provided with mechanically applied absorptive substance and adapted for use as a secondary battery element or electrode after being rendered active by an electric current, substantially as set forth.

"5. An improvement in the construction of a secondary battery element or electrode, said improvement consisting in a plate or suitable support provided with grooves, receptacles, or perforations primarily coated, combined, or filled with mechanically-applied absorptive substance, substantially as set forth.

"8. In the process of making plates or elements for secondary batteries, primarily and mechanically applying or combining with a suitable plate or support an absorptive substance adapted to be transformed into active material, substantially as set forth.

"10. In the process of making a secondary battery plate or element, combining by means of pressure an absorptive substance and suitable material to form a support therefor, substantially as set forth.

"11. In the process of making a secondary battery plate or element, constructing a suitable plate or support with grooves, cells, receptacles or perforations, said plate or support having an absorptive substance primarily applied thereto or combined therewith, substantially as set forth."

The second, No. 337,299, which is distinguished by the inventor as Case J, is for the same invention, substantially, as Case I. The drawings of the two are identical and the language of the specifications is very similar; where it differs, equivalent expressions are employed.

Perhaps the principal differences are the substitution of the words "active material" for the expression "absorptive substance adapted to be transformed into an active coating," of Case I, and the words "lead oxide" for the "granular or porous lead," of Case I.

The specification in question contains this additional statement:

"Peroxide is the best oxide of lead to use in the prepara-

tion of the plates; but as this is rather expensive to prepare, red lead or minium may be used. Some sulphate of lead is liable to be formed when this oxide of lead is employed, by the action of the sulphuric acid of the battery on it before peroxidation or reduction is effected. Protoxide of lead or litharge may also be used, but is objectionable, on account of the large quantity of sulphate of lead which is unavoidably produced by the action of the acid on it."

And also the following:

"I would have it understood that I do not restrict myself to any particular form of active or absorptive material, or to any particular method of applying it to or combining it with the plate or support, as my invention consists, broadly, in a secondary battery plate or element having active or absorptive material primarily and mechanically applied thereto or combined therewith, as contradistinguished from a plate or element having the active material produced by the disintegrating action of electricity, as in the well known Planté process."

The claims alleged to be infringed are the first, second, third, sixth, seventh, eleventh, twelfth and thirteenth. They are as follows:

"1. A secondary battery element or electrode consisting of a plate or suitable support primarily coated or combined with mechanically applied active material or material adapted to become active, substantially as set forth.

"2. In a secondary battery, an electrode consisting of a plate or support provided with a coating or surface layer of an absorptive substance, such as metallic oxide, applied thereto, substantially as set forth.

"3. A plate or suitable support primarily coated or combined with mechanically-applied oxide of lead or equivalent lead compound, substantially as set forth.

"6. A plate or suitable support provided with grooves, perforations or receptacles, and primarily coated, combined or filled with mechanically applied active material or ma-

terial adapted to become active, substantially as set forth.

"7. A plate or suitable support provided with grooves, perforations or receptacles, and primarily coated, combined or filled with mechanically-applied oxide of lead or equivalent lead compound substantially as set forth.

"11. In the construction of secondary battery elements or electrodes, a plate or suitable support primarily coated or combined with mechanically-applied red lead, substantially as set forth.

"12. The method of making plates or electrodes for secondary batteries, consisting in primarily combining active material with suitable plates or supports mechanically, in contradistinction to forming the active material by an electrical disintegration of the plate or support, substantially as set forth.

"13. The method of making plates or electrodes for secondary batteries, consisting in coating the plates or supports with red lead prior to their immersion in the battery fluid, substantially as set forth."

These two patents, Nos. 337,298 and 337,299, are fundamental patents designed to cover the broad inventions of Mr. Brush.

No. 260,654 is a division of Case J and is distinguished by the inventor as Case J, Division A

The invention "consists in the method of making the plates of a secondary battery consisting in forming receptacles for oxide of lead in its surface, then applying oxide of lead to the plates and within such receptacles and afterward subjecting the oxide of lead to pressure."

The drawings of this patent are identical with those of the preceding patents, except that Fig. 1, showing the use of cardboard or felt, is omitted.

The specification contains the statements above quoted from Case J, relative to peroxide being the best oxide of lead to use, and says, further, that the oxide of lead may be retained in place by being rammed or pressed into its receptacles, cells or grooves.

The single claim is as follows:

"The method of forming the plates of a secondary bat-

tery, consisting in forming receptacles for oxide of lead in its surface, then applying oxide of lead to the plate and within such receptacles, and afterward subjecting the oxide of lead to pressure."

In No. 266,090, distinguished as Case C, the invention consists in a secondary battery element, constructed of cast lead or other suitable substance, having cells, receptacles, ribs or projection in its surface, whereby an extended surface of metal is exposed to action.

The drawings are the same as those attached to the preceding patents, with some new ones added, showing the plates arranged ready for charging.

The specification says of Fig. 4 that it shows a modified form of ribbed plate resembling an ordinary window-blind with the slats open. It may also be regarded as a thick plate perforated with a series of parallel slots. And of Fig. 5, that it shows the honey-comb form of plate, resembling in construction a simple or double comb of beeswax. It may have its cells extending entirely through the plate.

The plates may be made by pressing plain sheets of lead or other suitable metal into dies or forms by hydraulic or other means, also by slotting, punching or otherwise perforating suitable plates, and also by casting the melted metal into suitable molds.

The claims alleged to be infringed are first, third, fourth, fifth, sixth, seventh, eighth, ninth, twelfth and fourteenth. They are as follows:

"1. In a secondary battery, an element or electrode made up of a series of ribs, substantially as and for the purposes set forth.

"3. A secondary battery element or electrode having its body support or frame provided with ribs.

"4. In a secondary battery, the combination, with one cell thereof of two or more ribbed plates or elements, substantially as set forth.

"5. In a secondary battery, a plate, frame, or other sustaining body provided with ribs or their equivalent, of a less general thickness than the said plate or support, substantially as set forth.

"6. In a secondary battery, a plate, frame, or other sustaining body provided with ribs or their equivalents, said ribs or their equivalents being thicker at their bases than at their free edges or ends, substantially as set forth.

"7. A secondary battery element or electrode having its frame, support or body provided with cells or cavities, the walls of said cells or cavities, or the septa, between them having an increasing thickness from their outer or free edges inward.

"8. In a secondary battery, plates or elements provided with comparatively thin ribs, or their equivalents, for surface exposure, and thicker ribs suitably disposed for supporting or stiffening purposes, substantially as set forth.

"9. A secondary battery having a body frame or support of cast-lead.

"12. A secondary battery element or electrode having a supporting body or frame of cast lead for the active coating or substance, said body or frame provided with ribs or projections.

"14. A secondary battery element or electrode having a supporting body or frame of cast-lead for the active coating or substance said body or frame provided with slots, perforations or openings."

The defendants have made, used and sold secondary or storage batteries composed of a series of electrodes, consisting of a cast metal support plate, 96 per cent. being metallic lead, and an exterior spongy or porous coating of mechanically applied active material consisting of lead oxides. These electrodes are placed in an electrolyte of dilute sulphuric acid in water. The charging current converts the lead oxide coating upon the oxygen plates into peroxide of lead and reduces the lead oxide coating upon the hydrogen plates to the condition of spongy or porous metallic lead. The battery is capable of numerous charges and discharges, in the course of which the active material undergoes successive reductions and reoxidations. The lead oxides used consisted generally of minium and litharge, the former largely predominating in the mixture applied to the oxygen plates and the latter predominating in the mixture applied to the hydrogen plates

The defenses to all of these patents are anticipation, want of novelty, lack of invention, abandonment (except of No. 260,654), and that the claims have been fatally broadened. As to cases I and J, it is said that the scope of the original applications had been unlawfully enlarged; that the patents expired with an Italian patent to Brush containing the same invention, and, finally, that they are for the same inventions, and that one of them is, therefore, void.

It is also insisted that No. 266,090 is limited by the

(Continued on 3d col. p. 62.)

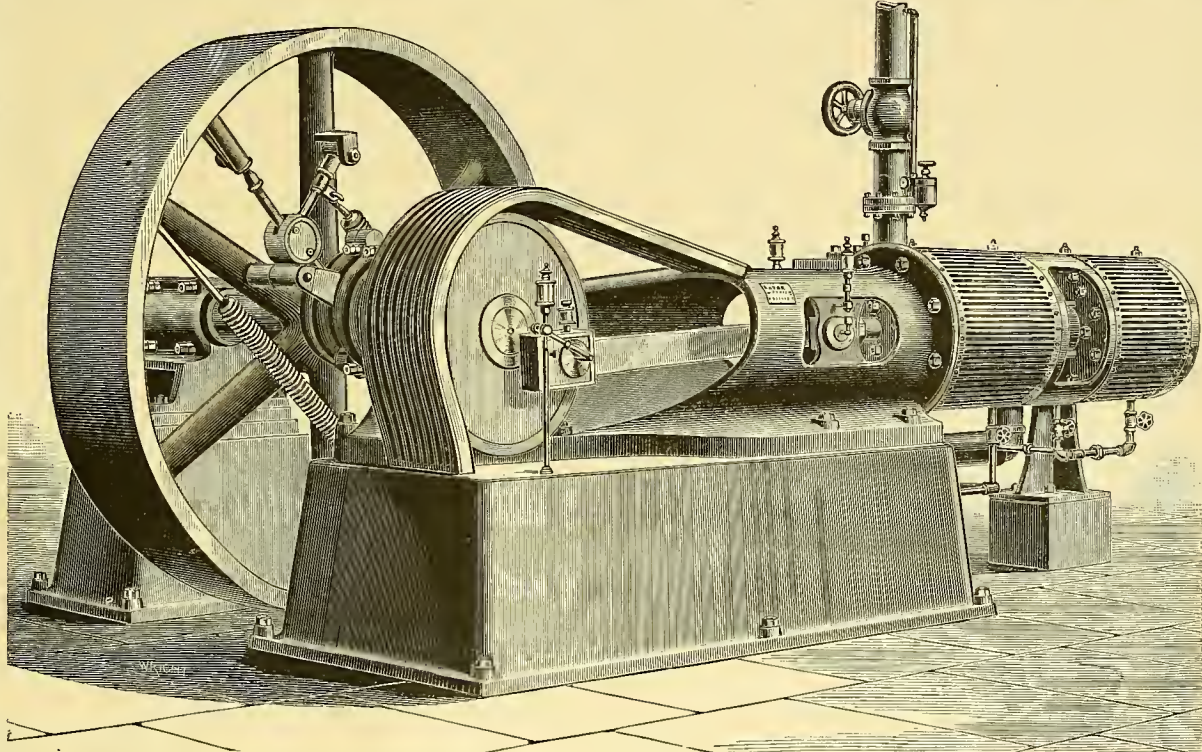



# The Street Railway Gazette.

S. L. K. MONROE, - - - - - MANAGER.  
 E. V. CAVELL, - - - - - EDITOR.  
 EDWARD J. LAWLESS, - - - ASSOCIATE EDITOR.  
 W. L. S. BAYLEY, - - - - - MECHANICAL EXPERT.

### GENERAL OFFICES:

CHICAGO:

8 LAKESIDE BUILDING.

AGENCIES } San Francisco, - - - 1222 Bush Street.  
 } Toronto (Canada), - - - 53 Magill Street.  
 Cable Address=TRAM, CHICAGO.

Annual Subscription (Including Postage).	Per Copy
United States, Canada.....	\$2.00. .... 25c.
Great Britain, Ireland, India, Australia 10s.	..... 1s.
Germany.....	9mk. 75 pf. .... 89pf.
France, Belgium, Switzerland.....	21fr. 95c. .... Fr 1.10.
Spain.....	21ps. 95c. .... Fs 1.10.
Austria, Holland.....	6d. 74c. .... 55c.
Italy.....	12 lire. .... 1½ lira.
Venezuela.....	12 bolivars. .... 1½ bol.
Mexico.....	\$3.00. .... 30c.

Annual Subscriptions in Argentine Republic, 2½ peso; Brazil, milres; Turkey, 54 piasters.

[Entered at the Chicago post-office as second-class matter.]

\*.\*

Matter for publication should reach the Chicago Office not later than the last day of each month. All communications should be addressed, THE STREET RAILWAY GAZETTE, Chicago, Ill.

### Announcement.

Owing to pressure of matter of greater importance, in this issue, we have been compelled to omit the publication of our usual list of Electric Street Railways of North America, together with the Quotations of Street Railway Securities, Bond Offerings, Patents, etc., all of which will appear in corrected form in our next issue.

### The Brush Decision.

We publish in this issue a verbatim report of the decision lately rendered by Judge Coxe in the United States Circuit Court for the Southern District of New York, in the case of the Brush Electric company vs. the Julien Electric company. Important as this decision is, we notice that none of the technical journals give a very exhaustive statement as to its scope. We fail to see that any of them state in their reference to the decision, just what has been decided; and one journal in particular, the *Electrical World*,—usually very correct and conservative in its statements—appears to have an erroneous idea of the subject matter of the suit.

The Brush Electric company sued the Julien Electric company for the infringement of two broad claims made by Mr. Brush for improvements in storage batteries.

First: For the application of the active material, or an absorptive substance to a support plate. This claim was allowed Mr. Brush; and in allowing it, Judge Coxe says that the words "active matter" and "absorptive substance" are synonymous. It naturally follows that the application of any absorptive substance, no matter of what nature or in what form it may be applied, to a support plate, is an infringement of Mr. Brush's patent. The patent containing this claim runs for seventeen (17) years from March, 1886.

The other claim is for a support plate with receptacles. This claim has also been sustained.

It will, therefore, be impossible to use a support plate containing holes, cavities, perforations or receptacles of any nature without infringing Mr. Brush's patent.

The paper to which we have above referred, attempts to throw doubt on the finality of this decision, and in doing so appears to us to have fallen into many errors.

It recites that the suit of the Brush Electric company vs. the Electrical Accumulator company, which is now pending, involves the real questions at issue. The inference naturally to be drawn from this statement would be that the case of the Brush Electric company vs. the Julien Electric company did *not* involve the real questions at issue. We understand that the editor of the *Electrical World* has admitted that this is not the construction which he intended should be put upon his words, but we do not find that he has corrected it in any subsequent number of his journal. The fact is, that the issues between the case that has just been decided and the one now pending between the Brush Electric company and the Electrical Accumulator company are identical, as the record in both cases disclose. Each defendant has been sued by Mr. Brush for the application of active matter or absorptive substance to a support plate. Both defendants are sued for having done the very same thing, to-wit, pasting a perforated support plate with minium and litharge. What is more, we are informed on the very best authority that the defence so far made by the Electrical Accumulator company is almost identical with that made by the Julien Electric company.

Another error which the editor of that journal appears to have made is when he states that the "Interference between these two claimants in the patent office resulted in favor of the former, inasmuch as the date of the Faure patents in this country was held to limit the question of priority." The date of the Faure patents in this country "had nothing to do with the case." It was the date of the French patent, to-wit, October 20, 1880, that limited Mr Faure's priority.

He then goes on to state that "still another of the questions left in doubt by this recent decision is that involved in the expiration of the Italian patent to Brush, a question which was not pressed to an issue in the present suit, but may appear in litigation at a later day." The Italian patent was most certainly pressed to issue in this suit, and several pages of the argument of the counsel for the defendant, are devoted to the attempt to convince the court that Mr. Brush's American patent was invalidated by the Italian patent.

Judge Coxe, referring to the Italian patent, says in substance that he regretted the defendants did not give any expert testimony whereby the court might be enlightened as to whether the Italian patent was or was not an anticipation of the American patent. In answer to this we are informed that the expert of the defendant could not conscientiously testify to that effect.

The reference by the same journal to the fact that the results may be influenced somewhat "owing to the fact that the litigants had arrived at a mutual understanding prior to the decision" appears to us to be hardly fair or just to the parties to the suit, without going further and stating that the "mutual understanding" was reached only after all the evidence in the case had been closed.

The decision is one of the most important and far-reaching that has been rendered for some time.

(Continued from page 61.)

Italian patent. Invalidity and non infringement of several claims are alleged.

Are Cases I and J for the same invention, and, if so, what course should be pursued regarding them? It will simplify the controversy to answer this question at the outset.

As stated above, the drawings of the two patents are the same, and the language of the specifications and claims are substantially alike upon all matters material.

The contention of the complainant is that Case I is for a secondary battery support mechanically coated with an absorptive material, and Case J for a similar support coated with an active material; "the distinction between the two relating to the condition and inherent capacity of the material of the coating as that material exists at the time of mechanical application." For instance, the spongy lead of Case I has, it is said, no oxygen and is initially absorptive and inactive, while the peroxide of Case J is a fully saturated oxygen compound and is, therefore, active and non-absorptive. It is admitted that the moment a battery, constructed with plates having either coating, is charged or discharged, all distinction vanishes.

"The fundamental distinction between these patents," says the complainant's brief, "is that in the former the coatings of the secondary battery electrodes, are, broadly, mechanically applied absorptive substance, while in the latter these coatings are that class of mechanically applied absorptive substance defined as active material."

Therefore, both patents, it is alleged, are valid.

This question, though it is an accurate statement of the difference between the two, would seem quite tantamount to an assertion that a party may have a patent for a device composed of a combination of iron and wood and a second patent for the same device composed of iron and basswood or hemlock.

One who has a patent for a combination, one element of which is an adhesive substance may not have a second patent for a combination, identical in every respect, except that the adhesive material suggested must be moistened before it becomes adhesive.

The coatings of both patents being absorptive and active, is the fact that one, prior to immersion in the electrolyte, has absorbed and that the other will at once absorb, a sufficient dissimilarity upon which to base invention? Is it a patentable distinction? The difference is one which would hardly occur to a practical electrician, and even specialists enthusiastic in the cause of the patent find it difficult to state it in words which are intelligible to ordinary men. It is too esoteric, metaphysical and minute. It is a mere theory of the scientists, and not a fact upon which to found a patent.

The essence of Brush's broad invention was an improvement upon the secondary batteries of Planté, by adding the porous layer mechanically to the supports, in the manner described, instead of forming it by the tedious and inefficient process of disintegration in the body of the plates themselves. When he is thoroughly protected in this invention he has received all that he is entitled to. By taking two patents he should not be permitted to multiply claims which could not stand side by side in one and the same patent.

There seems to be little controversy that absorptive substance and active material are used in the art as synonymous and equivalent terms, and have been so used since the time of Planté. The inventor, himself, apparently so understands it, for he has frequently used them interchangeably, not only in his testimony, but in the patent (Case J) itself.

Prof. Barker says: "To a person skilled in the art, as it seems to me, the terms are only different forms of expression for one and the same thing. A secondary battery electrode, such as is contemplated in these patents, can consist of but two essential parts: (1) the material of the coating which gives to the battery its usefulness, and to which is due its capacity of storing electrical energy, and (2) the conducting frame or support upon which this material is spread. Since upon the former the action of the secondary battery depends, it has become the general practice to speak of it as the "active material" of the electrode, in contradistinction to the support of the plate itself, which is or should be inert. The function of the coating is to change its chemical condition, as, for example, its state of oxidation, so far as to vary this condition in one direction in charging and in another on discharging. . . . Since, in my judgment, granular, porous or spongy lead, the substance of the first patent is 'active material or material adapted to become active' in the words of the second; and since the oxides of lead of the second patent 'are absorptive substances adapted to be transformed into an active coating' in the first, I am of the opinion that the 'absorptive substance' of the first patent and the 'active material' of the second are to be understood as equivalent terms." The court is fully satisfied that this conclusion is correct.

The identity of the two patents can best be illustrated by placing similar claims in juxtaposition; the first claim of Case I, and the first and second claims of Case J, for instance:

Case I.	Case J.
1. A suitable plate or support provided with mechanically-applied absorptive substance and adapted for use as a secondary battery element or electrode after being rendered active by an electric current, substantially as set forth.	1. A secondary battery element or electrode consisting of a plate or suitable support primarily coated or combined with mechanically-applied active material or material adapted to become active, substantially as set forth.
	2. In a secondary battery and electrode consisting of a plate or support provided with a coating or surface layer of an absorptive substance, such as metallic oxide, applied thereto, substantially as set forth.



There can be no question, if "absorptive substance" and "active material" are equivalent terms, that these claims are for the same invention. Each has the following elements: (1) A secondary battery support plate, (2) mechanically coated with (3) an absorptive or active material.

The question then, is: Can a patentee who has received a patent for a plate coated with absorptive substance obtain another patent for the same plate coated with active material? Can an inventor obtain two patents for a broad invention because in one he practices the invention with one substance, and in the other he practices it with an equivalent substance? Manifestly not!

After Case I no one could have a patent for Case J, even if confined solely to the points wherein the two are said to differ. The former includes the latter. I am constrained to say, therefore, that the two patents are, in legal contemplation, the same. Although the possibility that the court might reach the conclusion was stated at the argument, neither counsel offered any solution of the difficulty and none has been offered since. The situation is certainly an unusual one. Here are two patents for the same invention applied for at the same time and granted at the same time. It is true that no injury can result in this particular instance, but what would be the situation if one of these patents were owned by a third party and a suit were brought on it against the defendants for the same infringement, or if the second patent were granted years after the first? If the principle is once established that an inventor can, by such inconsequential changes as here are shown, obtain two patents for the same invention, the greatest injuries may be done, both to competitors and to the public.

It would seem that the inventor had given Case I the preference; and as his expert regards that as the broader of the two patents, the difficulty might be met by a surrender of Case J, or perhaps by a disclaimer of similar claims in Case J, leaving those which have not been brought into controversy or considered, and, possibly, the red lead claims, to stand. But, as neither counsel has expressed his views on this subject, the method of carrying out the opinion of the Court can best be arranged on the settlement of the decree.

Many of the propositions now advanced were examined and decided, upon identical testimony, by this Court, in the case of *The Electrical Accumulator Company vs. The Julien Electric Company et al*, 38 Fed. Rep. 117. These need not be again considered.

A definition of a secondary battery was there attempted and is now adopted for the purpose of this controversy. When the present inventor refers to secondary battery he means precisely what Mr. Faure meant when he used that term.

It was further decided in the Accumulator case, that the exhibits which were the closest approximations to the invention were the article from the *Electrician* of 1863, the report of the Smithsonian Institution for 1856, the Grove gas battery, Planté's descriptions of 1872, and the patents to Kirchhoff and Percival. Faure's claim, before being limited by a disclaimer, was broad enough to cover a secondary battery electrode to which the active material was applied, not only mechanically, but by galvanic action, chemical precipitation or in any other way, so that it was not formed out of the plates themselves in the manner described by Planté.

The evidence referred to, together with the testimony of Mr. Brush, was regarded as sufficient to limit the Faure invention to the application of the active material in the one form described by him, namely, as a paste or cement. What effect the evidence disclosing the prior art had upon the patents in suit was, of course, not directly considered.

In the complainant's brief considerable space is devoted to the establishment of the proposition that Brush was, in legal contemplation at least, prior to Faure. It is thought that a discussion upon this point is unnecessary. The precise question was presented and decided in the interference proceedings before the Patent Office and in the Accumulator case. The defendant's counsel having there contended that Brush anticipated Faure, recognizes the impropriety of now contending that Faure anticipates Brush, and merely submits the testimony in this behalf without comment. The decision theretofore made upon the same state of facts will, therefore, be adhered to.

It was there decided—although the date was not definitely fixed—that Faure, being a citizen of France, and having conceived his invention in a foreign country, was not permitted to claim it here earlier than the date of the delivery of his French patent—Dec. 7, 1880. Faure's contributions to the art need not, therefore, be considered in this action.

The proof now offered to establish invention was carefully examined in the Accumulator case, and it was held that "the evidence of Mr. Brush as to what he accomplished in 1879 and 1880 must be accepted as true."

What did Brush accomplish?

A history of his experiments and their results is given at length in the other case (pages 129, 130, 131), and need not be again repeated. In brief, it is this: In the summer of 1879, he made secondary battery electrodes, by applying to suitable plates an active or absorptive coating consisting in three instances, respectively, of metallic lead in the form of a fine powder, red oxide of lead, and litharge. These coatings were held in place by a piece of blotting paper, a strip of wood and a string wound tightly around the whole. In July, 1880, he made lead plates with deep grooves; into the grooves of some he rammed yellow oxide of lead and in others sulphate of lead. In September, 1880, he made six plates grooved by a gang of circular saws, and filled the grooves of two by ramming them full of litharge, and of two by ramming them full of sulphate of lead. The electrodes thus constructed operated successfully in secondary batteries and produced satisfactory results.

Many other structures leading up to the invention were made, but it is not necessary to consider them in detail. It may be said, however, that from the time the idea first entered his mind until the applications were filed, Mr.

Brush was engaged, almost constantly, in progressive experiments and investigations.

For the reasons stated in the Accumulator case it is thought that this invention is not anticipated by the testimony of Professor Van der Weyde, the article from the *Electrician*, the Smithsonian report, the Grove battery, or the patents to Kirchhoff or Pulvermacher (39 Fed. Rep. 490.)

It was said of the patent granted to George C. Percival, April 3, 1886: The idea of Percival also, as shown in his United States Patent No. 53 668, was to improve on Planté's method by saving time and expense. He describes a secondary battery consisting of one pair of electrodes placed in a water-tight wooden box, divided in its centre by a porous partition. On each side of this partition is a layer of powdered gas carbon. These layers constitute the two electrodes, and when in use they are wet by a proper solution. For convenience in establishing connection with these layers there is on each end of the box a screw cup fastened to a strip of copper which is in contact with the carbon. "Lead or any other suitable metal in the form of a coarse powder may be substituted for the gas carbon. This appears to be somewhat analogous to some of the forms described by Faure. The complainant contends that the reference is valueless for the reason that there is no suggestion of a conducting support plate like Faure's, which holds the active layer and conducts electricity to each and all parts of it so that the whole material instantly becomes spongy and thus capable of receiving and discharging electricity. In short, that the Percival battery is without the Faure support plates." (Accumulator case, 38 Fed. Rep. 126).

It is argued that this patent is an anticipation of claims 1 and 8 of Case I. This is probably true, if a very broad construction is placed on these claims, but there is nothing in the record requiring such a construction. There is no evidence that a Percival battery was ever used or could be made operative. His invention does not seem to be on the line subsequently followed by Brush. He has no plate or support at all resembling those of the Brush patents. He has no coatings. His two copper connecting slips support nothing. The pulverized gas carbon is not mechanically applied to them; they are simply in contact with the gas carbon. Their presence is not necessary; they are put there for greater convenience only. Percival's electrodes are not coated supports at all; they are cells filled with coarse conducting powder and divided by a porous partition.

Percival's claim is for:

"The forming of the electrodes of a secondary pile of layers of gas-carbon or some other conducting powder, substantially as, and for the purpose herein before described."

It is not clear that he did not have in mind a lead, or other suitable plate with a layer or coating of active material mechanically applied thereto?

It would seem, then, that nothing in the record anticipates the Brush patent, Case I, when a construction commensurate with the invention is placed upon it. He did not invent secondary batteries or electrodes for such batteries having a layer of active material, or the use therein of a conducting powder, but he seems to have been the first in this country who held the absorptive substance, in the form of dry powder, in place on the supports by paper or equivalent material, and the first who rammed or pressed it into grooves or receptacles in the plates.

The invention of Case I was not abandoned by descriptions in Patents No. 261,512 and 261,995, granted to Mr. Brush, respectively, July 18 and August 1, 1882.

There is no evidence as to when the applications for those patents were filed, other than the date appearing upon the specification, and this would seem to be insufficient proof of the fact. But accepting this date, June 9, as the true one, only four days elapsed before the filing of the application of Case I—June 13.

The inventor was not responsible for the delay in the Patent Office, which was occasioned by interminable interference proceedings between him and other inventors. His intention not to abandon is demonstrated by the fact that the application for the patent in suit was made out and sworn to two days before the application for the prior patents were filed.

In *Holmes vs. Alarm Company*, 33 Fed. Rep. 254, this Court decided that where a patent fully describes an invention which could be claimed therein, and makes no reservation and gives no warning to the public, a second patent granted upon an application filed months after the first patent was issue, which claims simply the invention previously made public, is invalid. But the Court also used the following language, which seems quite applicable here:

"This is not the case of a patentee who has made application for the second patent before the first is issued. It would be manifestly unfair to hold him responsible for the action of the Patent Office in this regard."

It is thought no authority can be found holding an invention abandoned upon such facts as are here developed. I should be sorry to make a precedent now which can have little but the most technical reasoning to support it.

The patent is not invalidated by the introduction of the descriptive term "absorptive substance" after the original application was filed. The claims as originally stated use the language "mechanically applied porous, granular, spongy or equivalent lead." The claims as issued substitute the words, "mechanically applied absorptive substance." This did not change the invention. It was the employment, simply, of more apt and artistic terms for the comparatively clumsy language of the original.

It is argued that claims 5 and 11 of Case I have been unlawfully expanded by the insertion of the word "perforations" therein. Neither the specifications, claims or drawing, as originally filed, mention perforations extending through the plate. They first appear in an amendment filed June 1, 1882.

Prior to this, in the summer of 1881, Prof. Eaton had made perforated secondary battery plates. (Accumulator case, 38 Fed. Rep. 141.) John S. Sellon and Joseph Wilson Swan had described similar plates in their patents of March 10, 1882, and Nov. 22, 1881 respectively.

It is not contended that Mr. Brush ever made such a plate. There is no proof that he did, and he testifies that he cannot recall having done so.

The value of perforations extending through the plate seems to be conceded. Proof of the advantages of this construction appears in the record and the language of Sir William Thomson, who testified in the previous case, may be adopted as an epitome of what is affirmed by the witnesses here. (See Accumulator case, 38 Fed. Rep. 140.)

The complainant's brief contains the following:

"Thus perforations may in his view be a specific improvement over recesses or receptacles broadly considered, but recesses broadly considered in combination with the mechanically applied active or absorptive material in a secondary battery is the subject of the claims now under consideration." And again, "As to the improvement in recessed plates, which consisted in carrying the recesses through the plates and forming perforations, Mr. Brush has no separate claim for that specific improvement. Defendants insist that Swan has the prior right to that specific improvement. Brush's claims are for the broad ground of a recess, and it may be that Swan is entitled to be considered the first who carried the recess through the plates, making a recess which was also a perforation. But that question does not arise here."

But it seems that the question does arise. The claim is certainly susceptible of a construction covering a plate containing receptacles not only, but also perforations which go entirely through the plate. In other words it may be construed to cover the features Mr. Brush is entitled to, as well as the one he is not entitled to. So construed, an infringer, after paying complainant for the use of the recesses which belong to Brush, might also be compelled to pay for perforations which, so far as this patent is concerned, belonged to some one else—Eaton, Sellon or Swan. Neither of these gentlemen, if he had a patent for this specific improvement, could prevent complainant from using perforations as distinguished from recesses.

The common meaning of "perforation" is a hole or aperture through a body. It is argued that the patentee intended that this meaning should be adopted, for he says: "Fig. 8 shows a vertical section of a ribbed plate provided with slots or perforations extending through the plate." And yet, other parts of the specifications would indicate that he intended to make no distinction between perforations and receptacles. As before stated, the language quoted first appeared a year after the original application was filed. The court has grave doubt, therefore, whether these facts do not bring the case within the rule laid down in *Railway Co. vs. Sayles*, 97 U. S. 563; *Kittle vs. Hall*, 29 Fed. Rep., 508, 514, and cases cited.

But consideration should be given to the unusual circumstances attending the filings of so large a number of applications and drawings at or about the same time. The inventor seems to have thought that by cross references the information contained in all could be imported into each separately. This, certainly, bears upon the question of intent. The drawings which he afterwards filed in Case I were in fact filed with Case C, and were in the Patent Office when the application for Case I was filed. The third claim, as originally proposed, covered a ribbed, honey-combed or equivalent plate. If the claims as finally allowed may be fairly construed to cover nothing more than a honey-combed or equivalent plate, which certainly contemplates a plate containing cells or cavities, can it be said that the claims in question have been fatally expanded?

It is true that the ordinarily accepted meaning of the word "perforation" would imply an opening extending entirely through the plate, and such an opening the inventor could not engraft upon the original application. But the word may also have a meaning synonymous with "cavities" or "cells"; it may mean a hole not passing entirely through but into the centre or interior, and a plate with such perforations the inventor was at liberty, it would seem, to claim under the original application.

Such a construction does not interfere with the rights acquired by the public, for it does not permit the broadening of the claim. It holds the inventor strictly to what he asked for in the first instance.

When, by a liberal construction, a patent may be sustained, is it not the duty of the court to adopt it rather than one which, though possibly more plausible, will deprive the patentee of the fruits of a meritorious invention to which he is fairly entitled?

With considerable hesitation I shall hold that these claims, as thus construed, are valid. That they are infringed there can be little doubt. The defendants' electrodes have receptacles; they may be improved receptacles, but they are receptacles nevertheless. These claims do not cover the improvement.

Regarding the pressure claims, so called, the defenses are that they are void for want of invention, and if a construction is placed upon them sufficiently narrow to enable them to stand, the defendants do not infringe.

The tenth claim of 337,298 is as follows:

"In the process of making a secondary battery plate or element combining, by means of pressure, an absorptive substance and suitable material to form a support therefor, substantially as set forth."

The only claim of No. 260,654 is as follows:

"The method of forming the plates of a secondary battery, consisting in forming receptacles for oxides of lead in its surface, then applying oxide of lead to the plate and within such receptacles, and afterward subjecting the oxides of lead to pressure."

The latter is a narrower claim than the former, being limited to oxides of lead, to support plates having receptacles and to pressure after, and, therefore, in addition to, the mere mechanical application.

It is not denied that the prior art plainly reveals the use of pressure in making primary battery plates. The distinguishing feature of the invention of these claims is pressure. Every other element is covered by other claims. It is argued with plausibility and force that it is not invention for the patentee, with the coated plate before him, to sub-



ject it to treatment which he could easily have learned from Leclanché and others.

It is said that the function of pressure is the same whether used on a primary or secondary battery electrode, and that the claim can not be upheld by importing into it all the valuable features of the broad invention.

It is contended for the complainant, on the other hand, that pressure applied to secondary battery plates produces an entirely different result and performs an entirely different function from that produced when applied to primary battery plates.

If the claims are limited to the use of hydraulic, or other similar pressure, the court, as now advised, would be inclined to recognize the force of the complainant's contention.

But the construction asked for is broad enough to cover the application of the absorptive material with trowel or spatula and the incidental pressure attending this operation.

Says the complainant's expert: "In the plates of defendants' battery I find a series of small cells perfectly filled with an apparently uniform and extremely even mass of absorptive material. I know of no way in which this could have been effectively done except by spreading and forcing into the perforations the absorptive substance, either in the form of a paste or of a powder; generally the application of the absorptive substance to the plate is accomplished by means of a trowel or spatula; the support is usually laid upon a slab of some material such as slate or glass, and the absorptive material in the form of powder or paste, is spread over the plate and forced into the perforations; considerable pressure is always applied to the material to force it into the receptacles; the excess of material is removed by a spatula or some equivalent implement, and the plates are then quite smooth, the absorptive material at the receptacles having almost the thickness of the support plate. From a careful examination of defendant's batteries and from my general knowledge as to the methods employed, I am of the opinion that the absorptive material has been applied in substantially the manner of the tenth claim above described, and that considerable pressure has been employed in the operation."

There can be no doubt that a construction as broad as here demanded would invalidate the claim. It would cover a well known and exceedingly simple operation. It would cover the mechanical application of the coating. It is hard to conceive how it could be made to adhere without some degree of pressure. Even the blotting paper, stick and string of the 1879 electrode would infringe. Pressure such as this, it is believed, was not contemplated by the inventor. He had in view pressure, plus the chemical application, by means of which the coating would adhere more perfectly not only, but by which better conductivity could be obtained.

But if the narrower construction is given these claims, the defendants do not infringe; at least they have not been proved infringers.

I do not lose sight of Mr. Weston's later testimony taken April 3, 1889, but it seems to me that it adds nothing to his former statements upon which the court would be warranted in acting. It is hearsay merely and wholly indefinite as to time. The bill was filed in April, 1887, alleging that before the commencement of the action the defendants had infringed. This allegation is hardly sustained by the testimony of a witness taken two years later that he has been informed that the defendants have infringed for "some time."

The stipulation signed by the defendants' solicitors, designed to cover undisputed matters upon the subject of infringement, makes no mention of pressure.

Case C, No. 266 090, contains two classes of claims. The first class (claims 1 to 8 inclusive) relates to the form of the plates; the second class (claims 9, 12 and 14) to the material of which the plates are formed.

Claim 7 relates to a secondary battery electrode having its support provided with "cells or cavities," other claims of the first class relate to "ribs."

Claim 14, in addition to the element of cast lead, has also the element, not elsewhere claimed in this patent, of "slots, perforations or openings."

It is said that the defendants do not infringe the claims of the first class, other than the seventh, for the reason that they do not have a ribbed support plate. The language of the seventh claim described with much greater precision the defendants' supports than that of any other claim of this class. They certainly use cells or cavities. Whether they use ribs or not is, at least, doubtful.

If there were nothing in the art but the contributions of Mr. Brush, it is evident that a narrow construction must be given to these claims. Every word by which even a shade of distinction in the formation of these plates can be expressed, has been adopted. Advantages of the most surprising and mysterious character are said to lurk in the slightest change of size, shape or depth in the holes or recesses. In these circumstances a different rule should be adopted than if the art showed that all these methods of keeping the active material in place are, substantially, equivalents.

The defendants use a support filled with rows of uniform square holes. The Court is not prepared to say that the walls between these holes are ribs. The ordinary meaning of the word would have to be strained and distorted to make it cover "partitions or septa between the cavities," and especially so in an art where a restricted meaning is required. A careful reading of the specification confirms the impression that the patentee intended to use the word, not as now asserted, but in its ordinary sense as synonymous with projections or ridges. He intended to draw, and does draw a sharp distinction between plates with ribs and those with cells, cavities and perforations.

Claims 9 and 12 are clearly void for want of patentable novelty. Their only distinguishing feature is cast lead. The complainant, if its position is correctly understood, does not assert that there is anything patentable in casting lead. It is not alleged that the eleventh claim, which covers the process of casting, is infringed. Not only every skilled mechanic, but every schoolboy who has experimented with

melted lead, who was shown a model of defendants' grid, and asked to make a series of them, would at once suggest the idea of casting them in molds. This proposition is, virtually, conceded by the complainant's counsel, for, in speaking of the advantages of casting over rolling or pressing, they say: "If this latter were the only advantage and the only mode of operation and result then the invention would be old in any casting of a complex form, and that is the plane on which defendants deal with this invention; but the true understanding of the invention shows that it had its birth in the needs of secondary batteries that operate by expansion and contraction of a permanent coating which must not be allowed to get away from its support, and that its peculiar mode of operation and advantages exist only in such a battery."

What, then, is the novelty upon which these claims are sought to be sustained? It would seem to rest solely on the theory that cast lead produces better results on a secondary battery than rolled or pressed lead. A patent can not stand for a moment upon ground so narrow. Lead plates were old in secondary batteries, cast lead plates were old in primary batteries. The art of casting was old and free to all. The form of the plates desired would suggest casting them to the skilled artisan. This right being clear, it is idle to assert that one may cast his plates but shall not be permitted to use them after they are cast. It being quite impossible to pour melted lead into molds without producing cast lead the question arises: Can the person who first uses this obvious process in making secondary battery plates not only obtain a monopoly of the product but of the process as well? Manifestly not! It is not even the substitution of one known material for another. It is the substitution of one well known for another well known form of the same material.

In *Hotchkiss vs. Greenwood*, 11 How. 243, the Court says: "The improvement consists in the superiority of material, and which is not new, over that previously employed in making the knob. But this, of itself, can never be the subject of a patent. No one will pretend that a machine, made in whole or in part, of materials better adapted to the purpose for which it is used than the materials of which the old one is constructed, and for that reason better and cheaper, can be distinguished from the old one, or, in the sense of the patent law, can entitle the manufacturer to a patent. The difference is formal, and destitute of ingenuity or invention. It may afford evidence of judgment and skill in the selection and adaptation of the materials in the manufacture of the instrument for the purpose intended, but for nothing more."

See also *Bushing Co., vs. Doelger*, 23 Blatchf. 168, and cases cited.

With every disposition to act with liberality toward those who, with undoubted genius and untiring research, are developing this recently-discovered mine of industry, the Court can not ignore the repeated and uniform utterances of the Supreme Court upon this subject.

In addition to the familiar and oft quoted authorities, see the following decided at the present time:

*Burt vs. Evory*, Feb. 3, 1890; *Hill vs. Wooster*, Jan. 13, 1890; *Day vs. Railway Co.*, 132 U. S. 98; *Watson vs. Railway Co.*, Id. 161; *Marchand vs. Emken*, Id. 195; *Royer vs. Roth*, Id. 201.

Claim 14 may be construed as covering a combination, one element of which, the slots, etc., is new and useful, and is not covered by the other claims. The original specification and drawings, filed June 9, 1887, describe and show grooved, honey-combed and slotted plates. Indeed, the drawings, for the absence of which Case I is criticized, were filed at the outset in Case C.

Of Fig. 4, showing the slotted plate, the specifications say:

"Here the supporting plate between the ribs is removed, the latter being supported by the heavier side or end ribs and other intermediate transverse ribs if necessary. This modification is in form somewhat like an ordinary window blind with the slats open."

This can mean nothing else except that there were openings extending entirely through the plate. The specification as originally filed is sufficient, therefore, to support the claim.

Regarding the infringement of this claim and claim 7 there can be no doubt, and the same is true of the claims in controversy of Case I.

The point is suggested that the defendant Bracken is not proved to be an infringer, but the stipulation signed by the solicitors makes no distinction between the defendants.

The questions arising on the expiration of the Italian patent are of a serious character, and, in view of the elaborate attention given to the other defenses, would seem to demand greater consideration in the testimony and in the briefs. The patent appears in the record, but no word of explanation, so far as can be discovered, has been offered on the part of the defendants. The only testimony explanatory of the patent is the clear and positive statement of the complainant's expert, that it describes and claims inventions entirely different from those of the patents in controversy.

The patent contains five divisions and twenty two claims. It requires little expert knowledge to perceive that some of these are wholly dissimilar to the inventions in suit. Others would seem to be dangerously near to some of the inventions, but those portions of the Italian patent, which seems to the Court to be most in point are but little discussed, and in some instances are not even alluded to in the defendants' brief.

For example, take a portion of Division D and its corresponding claims. The Italian patent says:

"To form an element having a core or body coated with the mass described, I take a sheet or other suitable piece of lead, or of other substance suitable for the purpose, and if necessary roughen or score its surface, or pierce it with numerous perforations to insure a firm adhesion of the mass which is to constitute the active coating. I cover it with the finely divided superficially oxidized lead (or the mixture of metallic lead and lead oxide particles) and apply

heavy pressure. The result is that the finely divided particles are not only pressed into a firm and strongly coherent mass, but the mass is also firmly united to the supporting core or body. This core may be of lead, or it may consist of non-oxidizable metal, such as gold or platinum, or any alloy of these metals with lead."

Claim 17 of the Italian patent is as follows: "A process for making secondary battery elements (or material from which said elements can be constructed); said process consisting in covering one, or more, or all of the surfaces of a suitable metallic and electro-conducting core or body, either with superficially oxidized particles of lead, or with a mixture of particles of pure lead and lead oxide, and, afterward, applying pressure sufficient both to unite said particles or mixture into a compact and firmly coherent mass, and to unite the mass to the core of body, as set forth in 'Division D.'"

Bearing in mind the fact that metallic lead and lead oxide are absorptive or active material, a comparison with some of the claims in controversy will certainly show marked features of similarity.

Claim 10 of Case I is as follows: "In the process of making a secondary battery plate or element, combining by means of pressure an absorptive substance and suitable material to form a support therefor, substantially as set forth"

To the uninitiated it would seem that these claims are for similar inventions. Would not a person, following the formula of the Italian patent, infringe the pressure claims of the patent in suit? Is not the method of making electrodes by pressing active material upon the support set free "by the expiration of the Italian patent?"

It is also true that Division D of the Italian patent describes also the process of uniting the absorptive substance into a compact or firmly adherent body or mass without the intervention of a support plate, but to the ordinary reader it would seem to be reasonably clear that when the inventor says, as in the description quoted, that he takes a sheet of lead, pierces it with numerous perforations to insure a firm adhesion of the mass which is to constitute the active coating, covers the support with the mixture of metallic lead and applies heavy pressure, so that the mass is not only pressed together but is also firmly united to the supporting core, he is describing the process which is covered by the claim in question.

Other claims of the Italian patent are as follows: "11. As a new article of manufacture, a mass consisting of a mechanical mixture or association of metallic lead and oxide of lead, united by pressure into a coherent and firm body, substantially as set forth in 'Division D.'"

"14. For use in an element of a secondary battery, a metallic core, or body, to one or more sides of which is attached a mass or substance, primarily consisting of metallic lead and oxide of lead, united by pressure so as to be strong and firmly coherent, substantially as set forth in 'Division D.'"

"15. A secondary battery element, consisting of a metallic core, or body having attached to it a coating primarily consisting of mixed lead and oxide of lead, firmly united by pressure into a strong and coherent mass, substantially as set forth in 'Division D.'"

"16. A secondary battery element, consisting of the combination with a metallic supporting core or body of a coating attached or united to said core; said coating primarily consisting of metallic lead and lead oxide in an intimately commingled state, united by pressure into a strong and firmly coherent mass, substantially as set forth in 'Division D.'"

It will be observed that the first of these, Claim 11, covers only lead and oxide of lead mixed and united by pressure into a coherent mass for use as an electrode or as a coating. The element of a support plate is wanting in this claim, but it is present, under the name of "a metallic core or body," in all the others.

Compare these claims with the pressure claims of the patents in suit, but also compare them—and particularly claim 11—with claims 12 and 13 of Case I. They are as follows:

"12. Absorptive material for use in secondary batteries formed into a coherent mass by pressure, substantially as set forth."

"13. For use in secondary batteries, porous, granular, spongy, or equivalent lead formed into a coherent mass by pressure, substantially as set forth."

The language is different, but in substance, where is the lack of identity?

But all these are questions which the Court, in view of the action of the American and Italian patent officials, in distinguishing between the inventions covered by the Italian patent and those covered by the patent in suit, and in view of the uncontradicted opinion of the complainant's expert, should hesitate long before answering in the affirmative.

Mr. Weston says of "Division D" of the Italian patent: "It is for an improved form of electrode especially adapted to the foundation by electrical disintegration, either by the Planté method, or by the peculiar method of electrical disintegration invented by Mr. Brush and described in Division A."

It should be remembered that we are dealing here with a mysterious and occult power of nature, the science of which is still in its infancy, the phenomena of which are but little understood, even by those who have made its study their life work. For one who has but a casual and superficial knowledge to place a construction upon a patent, which is addressed to those who are educated in this department of science, and which constantly employs terms of art, in opposition to the opinion of the only electrician who speaks upon the subject, would be unwarranted especially when such a construction will destroy rights and interests of great value. In very many of the patent causes which come before the courts, where the device is so simple that any man of ordinary capacity can understand it, the presence of an expert is wholly unnecessary, but when the invention relates to a subject where even the pioneers



re still groping in shadows, the court needs the instruction of those most competent to advise, and without such assistance should proceed with the utmost caution. The law does not favor forfeitures. A patent should never be declared invalid because of the expiration of a foreign patent, if there is doubt about the inventions being the same. The burden is upon the defendants and the doubt should be resolved in favor of the patent.

After such study as I have been able to give the subject, I am not satisfied that the Italian patent is for the same invention as those in controversy. It is sufficient, for present purposes, to state that the mind of the Court is in doubt upon the question.

The language of Judge Bradley in the case of *Bishop vs. Vethered*, 9 Wall, 312, where a patent was introduced, as here, without explanation, seems particularly applicable.

"The specifications of patents for inventions are documents of a peculiar kind. They profess to describe mechanisms and complicated machinery, chemical compositions and other manufactured products, which have their existence *in pais*, outside of the documents themselves; and which are commonly described by terms of the art or mystery to which they respectively belong; and these descriptions and terms of art often require peculiar knowledge and education to understand them aright; and slight verbal variations scarcely noticeable to a common reader, would be detected by an expert in the art, indicating an important variation in the invention. Indeed the whole subject matter of a patent is an embodied conception outside of the patent itself, which, to the mind of those expert in the art, stands out in clear and distinct relief, while it is often unperceived, or but dimly perceived by the uninitiated. This outward embodiment of the terms contained in the patent is the thing invented, and is to be properly sought, like the explanation of all latent ambiguities arising from the description of external things, by evidence *in pais*." It was, therefore, decided that the Circuit Court was right in charging the jury that there was not on the face of the respective patents such an identity as authorized the Court to pronounce that they were for one and the same invention.

No. 260,654 is not, in any event, affected by the Italian patent. The former bears date July 4, 1882, the latter Aug. 8, 1882, and it was not applied for till July 28, 1882.

It follows that upon filing a disclaimer of the invalid claims the complainant is entitled to a decree in accordance with this opinion, but without costs.

In connection with this decision the following statement should, I think, be made:

A suit similar to this is pending against the Electrical Accumulator company. Sometime after the oral argument in this cause was concluded, the counsel for that company, after due motion to all parties interested, called the attention of the Court to the following facts:

On the 28th of March, ten days after the decision on the above patent was filed, the president and secretary of the alien company, without the knowledge or consent of counsel, obtained from the complainant an option to take an exclusive license under the patents in suit provided they were sustained.

In view of these facts the Court was asked either to refuse to decide the case altogether or to postpone the decision until the cause against the Accumulator company is ready for argument.

The Court urged upon counsel the importance of having the issues passed upon in a controversy which is, in all respects, genuine and earnest, and expressed his own disinclination to decide an action where a suspicion to the contrary might exist. Several plans were suggested, but none upon which counsel could agree. As a decision in the other cause will not be reached for a year, and as the option alluded to is not regarded as a settlement of the cause, the conclusion has been reached that justice to the parties demands that a decision should be made at this time.

I regret having to inflict so long an opinion upon litigants and counsel, but the examination and study of a record and briefs aggregating twenty-five hundred printed pages, has made it impossible to devote the necessary time to review and condensation.

## LEGAL DECISIONS.

### COURTS OF LAST APPEAL.

IMPUTED NEGLIGENCE OF PARENTS IN CARE OF CHILD.—*Chicago West Div. Ry. Co. v. Ryan*; Supreme Court of Illinois, Jan. 21, 1890. 23 N. E. Rep. 386.

The accident upon which this suit is brought occurred on the first day of October, 1885. At that time the plaintiff was an infant not quite 17 months old. On Indiana street, which runs east and west in the West Division of the City of Chicago, and upon one of the street crossings, where Armour street, running north and south, crosses Indiana street, the plaintiff was struck and knocked down by one of the appellant's street cars, drawn by horses going eastward upon Indiana street. His feet were caught under the car wheels, and one of them so badly crushed that it was amputated a few hours after the injury. The child was so young that it was incapable of exercising care, and can not be charged with negligence. It is claimed that no recovery can be had against the defendant, unless the plaintiff's parents, or the custodian in whose charge they had placed him, exercised reasonable and ordinary care for safety. It is assigned as error that none of the instructions

given for the plaintiff required the jury to find the exercise of ordinary care by the parents or custodian, and that all the instructions asked by the defendant which did so were refused. From a judgment for plaintiff, defendant appealed. The Court say:—"The question in this case is whether the driver of the car could have avoided the injury to the plaintiff after the latter had been discovered to be a position of danger. Even though the plaintiff had come into such position through the negligence of those having him in charge, the defendant's servant who had control of the car, was bound to use reasonable care in evading an injury to the plaintiff, if he saw, or by the exercise of ordinary prudence, might have seen, plaintiff's peril. If B, in the performance of some lawful work of his own, such as operating a street car, has notice that A is in danger of being hurt by what B is doing, and that A is unable to escape the danger, then B must use reasonable care to prevent the threatened injury, and he is answerable for the want of such care. In *Railroad Co. v. Godfrey*, 71 Ill., 500, it was held that although a party was guilty of negligence in placing himself upon a railroad track at a point where he had no right to be, yet the railroad company 'might not, with impunity, wantonly or willfully injure him;' and in that case we said: 'If defendant's servants who were in the management of the engine, after becoming aware of plaintiff's danger, failed to use ordinary care to avoid injuring him, defendant might be liable.' In *Werner v. Railway Co.*, 81 Mo., 368, plaintiff's husband had fallen upon the railroad track in a state of intoxication, and while lying there was run over by one of the defendant's cars between 8 and 9 o'clock at night and killed. The driver testified that he saw an object ahead of the horses, but supposed it to be a bundle of hay or sack of oats. He could have stopped the car, but made no effort to do so, or to ascertain what the object was. It was there said: 'If the negligence of a defendant, which contributed directly to cause the injury, occurred after the danger in which the injured party had placed himself by his own negligence was, or by the exercise of reasonable care, might have been discovered by the defendant in time to have averted the injury, then defendant is liable, however gross the negligence of the injured party may have been in placing himself in such position of danger.' The doctrine is thus stated by Shearman & Redfield in their work on the Law of Negligence (Vol. I, p. 99, 4th Ed.): 'It is now perfectly well settled that the plaintiff may recover damages for an injury caused by the defendant's negligence, notwithstanding the plaintiff's own negligence exposed him to the risk of injury, if such injury was proximately caused by the defendant's omission, after becoming aware of the plaintiff's danger, to use ordinary care for the purpose of avoiding injury to him. We know of no court of last resort in which this rule is any longer disputed. \* \* \* The plaintiff should recover, notwithstanding his own negligence exposed him to the risk of injury, if the injury of which he complains was proximately caused by the omission of the defendant, after having such notice of plaintiff's danger as would put a prudent man upon his guard, to use ordinary care for the purpose of avoiding such injury. It is not necessary that the defendant should actually know of the danger to which the plaintiff is exposed. It is enough if he has sufficient notice or belief to put a prudent man on the alert, and he does not take such precautions as a prudent man would take under similar notice or belief.' In such cases where the person in danger of being injured is an adult, the defendant will only be liable for willful injury or gross negligence on the ground that the adult will be presumed to have the capacity of making some effort to remove himself out of the way of the threatened peril; but, in the case of a child of tender years, the defendant will be liable for the want of ordinary care. *Railroad Co. v. Spearen*, 47 Pa. St. 300." Judgment affirmed.

NEGLECTANCE IN ARRANGEMENT OF SIGNALS.—*Ferry v. Manhattan Ry. Co.*; Court of Appeals of New York, Feb. 25, 1890. 23 N. E. Rep. 822.

At the trial of an action against an elevated

railroad company for injuries sustained by a passenger while stepping from the car to the station platform, owing to the sudden starting of the train, a witness testified that, to steady himself when the train stopped, he caught hold of the bell-cord, and thereby gave the signal which caused the train to start. The court charged that if the jury found that the train was so started then defendant was not negligent, and plaintiff could not recover. Defendant could not have been prejudiced by the refusal of the court to charge that there was no proof that there was any negligence in the system of communicating signals, or that the method of fixing the bell-rope was not the best method, and that the jury were not to consider these questions.

NEGLECTANCE OF PARENTS IN CARE OF CHILDREN.—*Weil v. Drydock, E. B. & B. Railway company*; Court of Appeals of New York, January 21, 1890. 23 N. E. Rep., 486.

This is an action to recover for personal injuries sustained by the plaintiff in being run over by one of the cars of defendant company. From a judgment of non-suit plaintiff appeals. The court say: "The question here is whether or not the trial court was warranted in disposing of the case as a question of law instead of submitting it to the jury as one of fact. At the time of accident occurred, the plaintiff was a few days under two years of age, and the non-suit proceeded upon the grounds that her parents with whom she lived, neglected to exercise that care and restraint over her that the law requires in case of children of such tender years; that this negligence is imputable to the plaintiff and precludes her from recovering damages for injury. It appears that the plaintiff, with her father and mother at the time the accident occurred, resided on the first floor of a house in Lewis street, the father keeping a bakery store on the ground floor and a bakery underneath in the basement, and carrying on the bakery business. About four or five o'clock of the day, the mother took the child to her father in the store and requested him to take care of her. The child after playing and talking with her father for a couple of minutes, went behind the counter and remained there some time; while she was there, or at least while the father supposed she was there, he proceeded to make some entries on his books, and while he was thus engaged, the child escaped through the door into the street and was run over by one of the defendant's cars. In regard to the negligence of the defendant, it was shown that it was a one-horse car with a driver but no conductor. The driver could have seen the plaintiff in the street had he been looking ahead, but his attention was directed to the rear of the car and to the opposite side of the street to warn off some boys who were improperly attempting to ride upon the rear platform. It is apparent that the driver did not see and could not have seen the plaintiff when she was struck, as his back was towards the horses and the same rate of speed was kept up for a considerable distance past the point in the street where the accident occurred. There was therefore evidence in the case competent and proper for the consideration of the jury on the question of the defendant's negligence. We think that the trial court was not warranted in deciding that as a matter of law, parents of the plaintiff neglected to observe that degree of care and watchfulness in regard to her movements that the law imposed upon them. The parents were bound to protect her from danger so far as that could be done by the exercise of reasonable prudence and care. The law did not require the father to suspend his business and keep the child every moment under his eye; he was required to exercise such a degree of care as was reasonable in his situation and under all the circumstances of the case. Whether in this case the father did in fact all that a reasonable, careful and prudent man ought to have done under the circumstances, was a question for the jury and not for the court. *Birkett v. Ice company*, 110 N. Y., 506, 18 N. E. Rep., 108; *Kunz v. City of Troy*, 104 N. Y., 344, 10 N. E. Rep., 442; *Stackens v. Railroad company*, 79 N. Y., 464." Judgment reversed and new trial ordered.



## STREET RAILWAY NEWS.

See also "New Enterprises," "Extensions," "Elections," etc.

The following data is compiled with all possible care, but the publishers, receiving news as they do, from almost every state, territory and country, cannot be held responsible for errors, as it would be wholly impossible to obtain a verification of each item received by them in time for each issue.

## ARKANSAS.

**Little Rock**—The street car companies here have passed into the hands of a syndicate of which J. M. Taylor, of Pine Bluff, and George R. Brown and Wm. Stammers, of Little Rock, are members. We understand that the price paid for the stock is in the neighborhood of \$400,000.

## CALIFORNIA.

**Oakland**—We understand that the Fourteenth Street Railway company is to be reorganized, and that the road will probably be cabled.

## COLORADO.

**Denver**—The Denver Tramway company has been accorded the right to build and operate an electric street railway line on two of the principal streets of the city.

We understand that the Highlands Street Railway and the Berkeley Park Rapid Transit company will pool their issues and construct a rapid transit line at North Highlands. It is reported that the storage battery will be used.

**Pueblo**—The property, etc., of the Pueblo City Railway company has passed into the hands of the Chamberlin Investment Co.—J. E. Pussey and others—and the work of constructing and equipping the road will be proceeded as speedily as possible, and it is the intention of the syndicate to construct about twenty miles of track during the first year. (The list of directors will be found under the head of "Elections," in the present issue.)

**Santa Cruz**—A street railway is being built at this point.

## CONNECTICUT.

**Norwich**—The street railway company here has been accorded permission to use electric power for the operation of its cars.

## DELAWARE.

**Wilmington**—The Wilmington City R. R. Co. has been accorded permission to erect electric wire poles in the centre of Market street, from Eighth to Tenth streets. The poles are to be of iron, and located at a distance of 125 feet apart.

## FLORIDA.

**Leesburg**—We understand that a street railway will very probably be built here in the immediate future.

## GEORGIA.

**Athens**—The Classic City Street Railway has been extended to Rock College.

**Augusta**—An ordinance was recently granted to the Augusta Railway company for the construction of a street railroad upon a number of the principal streets. Among a number of other conditions, the following were by said ordinance imposed upon the railroad company:

"Said railroad shall be authorized to use and operate on said streets, railway carriages and cars to be propelled by electricity or by an endless cable. They shall be authorized to lay down and use double tracks, provided the space occupied by same shall not exceed fourteen (14) feet on any one street, and all the other provisions of this ordinance shall be applicable to said double tracks when used.

"SEC. 2. That if said railroad shall desire to use an endless cable to propel its cars, then said cable shall be laid and used under such terms and conditions and restrictions as council may ordain for the purpose of protecting persons and property.

"Said railroad shall be authorized to use electricity for propelling its cars under the following terms, conditions and restrictions, viz.: The poles for the support of cross section wires, as well as the parallel wires overhanging the track, shall be placed and the work connected therewith done under the supervision of the City Engineer in conjunction with the Chief of the Fire Department and Streets and Drains Committee of Council. The parallel wires shall not be less than nineteen feet from the street level. In the event use of said electricity shall at any time be declared a nuisance by council and courts, then the authority granted hereby to use the same shall be at once terminated and the use of same discontinued by said company."

## ILLINOIS.

**Venice**—Work on the proposed electric railway will be commenced at once and pushed to completion.

## INDIANA.

**Brownstown**—The street railway company, organized by a number of citizens of this place,

is now owned and controlled by about five of them, but we are unable to say when the company will be in active operation.

**Evansville**—We understand that the street railway company here has passed into the control of outside capitalists for \$225,000. (The news lacks confirmation.)

**Indianapolis**—The Citizens' Street Railway company has received a thirty-five years' franchise to use the streets of this city for street car purposes. The ordinance embracing the franchise provides that the West Indianapolis line shall be run in connection with the City line, passengers being entitled to transfer. Either animal or electric power will be used.

## IOWA.

**Keokuk**—The Keokuk Electric Street Railway and Power company has executed a mortgage for \$100,000 in favor of the International Trust company, of Boston, to secure 200 bonds for \$500. The bonds bear interest at the rate of 6 per cent. and expire in 1910.

**Sioux City**—We understand that the Highland Park Motor Railway has passed into the hands of a syndicate of which Messrs. J. F. Pearey, J. Booz, C. M. Swan, John Horrick, W. W. Vivian and others are members. We further understand that it is the intention of the syndicate to equip the motor line with electricity, and to make considerable extensions.

## MASSACHUSETTS.

**Lowell**—A project is on foot for the consolidation of the Lowell Horse Railroad company and the Lowell and Dracut Street Railroad company, and it is proposed that the new corporate name shall be the Lowell and Suburban Street Railway company.

**Nantucket**—The Nantucket Railroad company has not yet commenced operations toward relocating its tracks, and it is rumored that nothing will be done so long as the Electric Railway company holds a franchise to run a railway to Siasconset.

**Newburyport**—The Plum Island Street Railway company has been authorized to dispose of its property and franchises to the Black Rocks and Salisbury Beach company, which latter is authorized to increase its capital stock for the purpose of purchase from \$65,000 to \$125,000.

## MICHIGAN.

**Detroit**—The Fort Wayne and Elmwood Railway company has discarded all one-horse cars and put two-horse cars in their places.

**Lansing**—The Lansing Street Railway company has been sold to W. B. Skinner, of Des Moines, Iowa, and H. L. Hollister, of Sioux Falls, S. D.

## MINNESOTA.

**Duluth**—The Duluth Street Railway company has been accorded the right to construct, maintain and operate an elevated inclined street railway.

## MISSOURI.

**Kansas City**—The stockholders of the Kansas City Cable Railway company, at a recent meeting, issued bonds to the amount of \$300,000, to pay off the indebtedness incurred by its new lines.

The Rapid Transit Railway company has been granted the right of way upon Kansas avenue north from Eighth street to the Kansas River bridge and into North Topeka.

**St. Louis**—A Crosstown Electric Railway Co., of this city, has been incorporated, with a paid up capital stock of \$100,000; the following named gentlemen are prominent stockholders: Given Campbell, 40 shares; D. K. Furgerson, 20 shares; George W. Brown, 350 shares; P. P. Mammon, 70 shares; C. C. Carroll, 500 shares. It is expected that over 92 miles of electric street railway will be in operation in this city before Fall.

**Springfield**—Track laying has commenced on the Walnut Street Railway, and two more will be laid with the utmost possible despatch.

## NEW HAMPSHIRE.

**Concord**—The Concord Railway Co. has been authorized to operate its cars by electricity.

## NEW JERSEY.

**Asbury**—Information reaches us from this point, that the Mattawan Horse Railway Co. was sold at public auction last month, Mr. John W. Keough being the purchaser, and buying the

property in for \$5, subject to \$60,000 incurred by the company.

**Asbury Park**—We understand that the earnings of the electric railway at this point last year exceeded \$20,000.

**Newark**—Thomas C. Barr has resigned the Presidency of the People's Passenger Railway company, and the Omnibus Company General that he may devote his whole time to the system of passenger railways here, recently purchased by a syndicate of which he is president. Edward B. Murphy succeeds him as President of the People's company.

**Passaic**—The Passaic, Garfield and Clifton Railroad Co. has filed a mortgage on its property, a franchise, for \$60,000; a mortgage was given to the Atlantic Trust Co., which company guarantees the payment of bonds to the extent of \$60,000 with interest. Work is being pushed energetically all along the line, and it is very likely that the road will be extended to Paterson.

## NEW YORK.

**Albany**—We understand that negotiations are still pending between the directors of the Albany Railway company and the North and East Greenbush Horse Railway company for the sale of the road of the latter company to the former corporation. No definite understanding has been arrived at.

**Binghamton**—All the street railway companies here have been already consolidated, and the Hon. J. B. Lanfield is now president of the consolidation.

**Brooklyn**—The Brooklyn City and Newtown Railroad company is about to issue bonds to the value of two million. These bonds will bear interest at the rate of 5 per cent. We understand that the principal idea of the issuance of these bonds is to have one million dollars intact for permanent improvements, and for the substitution of cable or electric power for that of animal. \$600,000 is needed to redeem the present outstanding 7 per cent. bonds which mature in July and October. The mortgage to secure the bonds will be on all the property of the company and also all the property that it may hereafter acquire.

The Brooklyn City Railroad company is negotiating for the purchase of the Grand Street and Newtown Road, which runs from the foot of Broadway to the village of Newtown, a distance of six miles. The road was chartered in 1864 and cost \$450,000 to build.

It is proposed to bind Brooklyn and Dutchess county towns closer together by a street railway which will be known as the Gravesend, Flatlands and Brooklyn Street Railway, and it is very likely that the road will be built in the immediate future. When completed for the proposed distance it will be between 5 and 10 miles long.

**Beverly**—The board of railroad commissioners has granted the request of the Beverly and Danvers Street Railway Co. to connect with the line over the tracks of the Naumkeag Street Railway Co., on certain streets in Beverly.

**East Greenbush**—The secretary of the East Greenbush Horse Railroad company recently filed his report for the last quarter of 1889, with the railway commissioners at Albany. The report shows that the gross earnings amounted to \$2,442.31; operating expenses, \$2,315.34; fixed charges, \$305.10; loss from operation, \$178.13. The corresponding quarter for 1888 showed gross earnings of \$2,507.24, and loss from operation of the road, \$263.52.

**Lockport**—Information reached this office that the Overhead Trolley system is to be adopted here.

**New York City**—The Metropolitan and Croton Town Railway company, at a special meeting of the stockholders, decided to bond the road at 4 per cent in the amount of \$600,000, which said bonds are designed to run for 30 years, and are to be secured by a first mortgage upon all the effects of the road. The road was incorporated a year ago with a capital stock of \$300,000, at which time it will run cars from Grand Street Ferry to the Hoboken Ferry at West 14th street.

**Ogdensburg**—Stockholders of the Ogdensburg Street Railway Co. have been assessed in order to meet running expenses.

(According to our recollection of Ogdensburg



There is certainly a good field there for a well managed, thoroughly equipped street railway, and maybe the road will be gobbled up by outside parties, who will put it in first-class condition, with the result that a year hence "assessments" will take the form of "dividends."—E.D.)

**Poughkeepsie**—The Poughkeepsie Horse Railway Co. will issue bonds for \$20,000, secured by mortgage on the property, and the money is to be used in repairs and extensions.

**Rochester**—The following is the text of the opinion rendered by Judge Danforth regarding the termination of the franchise of the Rochester City and Brighton Railway:

To the Executive Committee of the Rochester Chamber of Commerce:

In answer to your inquiry I would say: The Rochester City and Brighton Railroad company had no right or privilege to construct its railroad in or through any of the streets of the city until the 24th of June, 1862. On that day the common council ordained that "it will permit to be constructed" by that company a railroad in the several streets of the city as specified in the ordinance "upon the terms, conditions and limitations therein mentioned," and by sections 24 and 25 expressly provided that the grant and franchises, rights and privileges proposed to be conferred in the company "shall be" limited to the term of thirty years from and after the date of acceptance of the same by the railroad company. This acceptance was required to be given by the company within sixty days in such manner as should be approved by the city attorney and be legally binding on the company. The company did accept the offer contained in the ordinance and so declared by an instrument signed by its officers and by a resolution of its directors, and its acceptance was approved by the city attorney and his certificate filed in the office of the city clerk on the 26th of June, 1862. Permission was subsequently given to lay the road on other streets in accordance as the ordinance stated, with the terms of the above ordinance.

By foreclosure of a mortgage executed by the company Mr. Woodworth afterwards became the owner of its property and franchises, and he in 1868 sold the same to a new company under the same name. This foreclosure and sale by Mr. Woodworth had no other effect than to vest Mr. Woodworth with the property and franchises of the former company, and the new company acquired nothing else from him. The franchises remained good, and so far as the streets mentioned in the ordinance and in subsequent resolutions are concerned, I entertain no doubt that the limitation prescribed by the ordinance applies.

In my opinion, therefore, all the rights, franchises and privileges conferred upon the Rochester City and Brighton Railroad over the streets named in that ordinance or subsequent resolutions will expire in the year one thousand eight hundred and ninety two. These streets are the principal ones of the city and are among those on which lines are now operated by the Rochester City and Brighton railroad.

I find nothing in any subsequent proceedings of the common council or the legislature which at all modifies or changes the effect of that ordinance or resolution.

GEORGE F. DANFORTH.

The Rochester Railway company has been incorporated, with a capital of \$500,000. It is intended to build a road connecting Rochester, Chili, Gates, Greece, Irondequoit, Briton, etc. The length of the road when completed will be about sixty miles. The names of trustees as follows: Frederick Cook, George E. Munford, William S. Kimball, Arthur G. Yates, Arthur Wetchford, Marsenus H. Briggs, John N. Beckley, Rochester; H. Seller McKee, Murry A. Werner, Pittsburgh; Benjamin Graham, New York; Richard W. Clay, Horace Megee, Thomas Hewitt Cuyler, Philadelphia.

**Saratoga Springs**—The Saratoga Electric Railway company has decided to increase its capital stock from \$50,000 to \$150,000.

**Troy**—The Troy & Lansingburg Railway company has increased its capital stock from \$350,000 to \$700,000.

**Utica**—The work on the belt line electric power station is rapidly approaching completion. The installation was made by the firm of Edward Hamson & Co., of New York city. We understand that there are over 44 miles of wire in the belt line system, to operate which six generators of 500 voltage are required. The power is furnished from three Armington & Sims compound condensing engines of 200 h. p. and capable of running 300 rev. per minute. It is expected that the plant will be in active operation during the present month.

The belt line here made its first trip under the Union Electric system on the evening of March 14th. On board the car were a number of prominent gentlemen, including the officers of the road and Mr. W. E. Haycox, superintendent of the company, to whose indefatigability and energy the splendid condition of the belt line is a large extent due. Mr. Walter Scott represented the Thomson-Houston Co. There were also a number of prominent city officers on the

car and a representative of the STREET RAILWAY GAZETTE. The car was put through some pretty severe tests, and in speeding fifteen miles per hour was attained. The officers of the company could not but feel entirely satisfied with the working of the system.

**White Plains**—The time for building the Portchester, White Plains and Tarrytown Electric railroad was extended to November 1.

NORTH CAROLINA.

**Asheville**—The Asheville Street Railway company has confessed judgment in favor of H. T. McGee in the sum of \$30,000 in order to liquidate its obligations and improve the condition and operation of its line.

OHIO.

**Brooklyn**—The Brooklyn Street Railway company has increased its capital stock from \$350,000 to \$600,000.

**Chillicothe**—We understand that negotiations are pending looking to the purchase of the street railway interests of this city by an eastern syndicate represented by Mr. M. Frost.

**Cleveland**—The Eastland Avenue and West-side Street Railway company, of this city, has increased its capital stock from \$1,000,000 to \$1,100,000.

**Tiffin**—The Tiffin Street Railway has been authorized to increase its capital stock from \$50,000 to \$150,000.

**Zanesville**—There is no doubt but what the street railway company here will adopt electricity as a motive power in the immediate future.

OREGON.

**Baker City**—The Baker City Street Railway company has purchased 200 acres of land south of the city for special purposes.

PENNSYLVANIA.

**Lancaster**—A charter for the Lancaster & Lititz Electric Railway (as reported in the last issue of the GAZETTE) has been issued, and the negotiations are that the road will be built during the coming year. The capital stock of the company is \$50,000.

The Lancaster City Street Railway company has decided upon the issue of mortgage bonds to the extent of \$260,000.

**Philadelphia**—The ordinance granting permission to the Lehigh Avenue Passenger Railway company to use electric storage batteries has been reported favorably by the Railroad Committee of Councils.

**Pittsburg**—The Duquesne Traction company has ordered one hundred cars from the Pullman Palace Car Co. through its contracting agent, Mr. Chas. L. Pullman, who visited Pittsburg for the purpose of securing the order. Each car is to have two four-wheeled trucks, the wheels being of the Allen tire and spoke patent, and the cars are to be delivered by August 15th.

The Pleasant Valley Street Railway company is erecting a new car house, 240 x 150 feet, to be built of terra cotta fire brick.

The eighteenth annual meeting of the board of managers of the Pittsburg & Castle Shannon was held at the office of the company on February 18th. At the meeting it was decided to operate a cable line from the head of the new inclined plane to the railroad station in Allentown.

**Scranton**—We understand that a movement is on foot by the Peoples' Street Railway company to acquire by purchase what is known as the South Scranton Railway.

**Williamsport**—News reaches us that a Philadelphia syndicate has obtained control of the street railway property here, the purchase price being placed at \$100,000.

RHODE ISLAND.

**Woonsocket**—At a recent meeting of the stockholders of the Woonsocket Street Railway company, it was voted to change from horse to electric power, and the president and treasurer were directed to close a contract with one of the electrical companies for the equipment of the entire line.

SOUTH CAROLINA.

**Charleston**—It is very likely that the Enterprise Street Railway here will be operated by electricity in the near future.

TENNESSEE.

**Nashville**—The report has reached this office that the different street car companies here have

ratified their consolidation with the Union Electric Street Railway company of this city, under which name the street car lines here will be operated in future. Over fifty miles of electric railway will probably be in operation before long.

VERMONT.

**Burlington**—The Winooski and Burlington Horse Railroad company has declared a quarterly dividend of 1 per cent.

DISTRICT OF COLUMBIA.

**Washington**—A bill to incorporate the Washington Cable Railway company, which was recently introduced into the house, has been reported adversely. The following named gentlemen were interested in the project: Francis G. Newlands, Frederick W. Sharon, Curtis J. Hillyer, William K. Ryan, H. Rozier Dulaney, General C. Bullett and Arthur Horr.

WASHINGTON TERRITORY.

**Anacortes**—It is very likely that the electric road projected to run from this point to Fiedalgo, a distance of seven miles, will be in operation this fall.

**Seattle**—The Yesler Avenue and Jackson Street Cable Road has been re-incorporated by the new managers. The incorporators are Fred E. Sander, Henry K. Hall and L. B. Burns. The capital stock is placed at \$600,000.

WISCONSIN.

**Madison**—An item reaches us from this point stating that the Douglass Street Railway company has filed amended articles increasing its capital stock to \$50,000.

NEW ENTERPRISES.

ALABAMA.

**Auburn**—We understand that a dummy line will be built from this point to Opelika.

CALIFORNIA.

**Alameda**—Theodore M. Wetz, president of the Oakland and Piedmonte railroad company, has applied for a franchise to construct and operate a street railroad on certain streets of the city.

COLORADO.

**Boulder**—A syndicate is desirous of obtaining a fifty-year charter for the purpose of building a street railway through the main streets of the city. Messrs. James McLean of New York, S. F. Heath, J. M. Hunter and Henry Stevens are interested.

**Colorado City**—An ordinance has been passed by the council granting a franchise to the Electric Motor Line here, provisional upon the completion of the line by July 1st, upon which it must also be in operation.

**Colorado Springs**—We understand that the rapid transit Electric Railway company will operate about sixteen miles of line when the construction of the same is completed. A list of the officers of the company will be found under the head of Elections in this issue.

The Palmer Lake Street Car company has been incorporated by E. S. Hall, J. S. Judd, J. M. Younger, E. C. Gard, B. B. Roberts, S. C. Agnew, T. A. Hawks and John Munger. The capital stock is \$10,000—100 shares at \$100 each. (A list of the directors will be found under head of Elections in present issue.)

**Denver**—The mayor has recently signed an ordinance passed by the city council granting a franchise to the Colfax Avenue Electric Street Railway company, which will operate a line from York St. to the city limits here.

**Sloan's Lake**—We understand that an electric railway will probably be built from this point to Highlands in the immediate future; local capitalists will construct and operate the road.

CONNECTICUT.

**New Haven**—We understand that a street railroad will be built to Union depot from New Haven during the coming summer.

**West Manchester**—The McGregorville line of horse railway will be built in West Manchester this season.

DAKOTA.

**Rapid City**—An electric street railway is projected for this point.

GEORGIA.

**Savannah**—A charter has been granted Messrs. Sandlin & Dahl, covering five miles of street, of which one mile is to be pushed to completion.



**Trenton**—A charter has been granted for a street railway and dummy line from Rising Fawn, via Trenton, New England and Wildwood, to the Tennessee line, as also for an electric light and motor company.

## ILLINOIS.

**Alton**—Property owners along certain streets here will probably organize a company very soon for the building of a motor line. Prominent real estate men will probably take the matter up.

**Aurora**—We understand that New York capitalists are arranging to build an electric street railway in this city.

**Chicago**—The Chicago Suburban Belt Line Passenger R. R. and Extension Street Ry. Co., has been incorporated, with a capital stock of \$2,500,000, for the purpose of constructing a suburban belt line passenger railway, to be operated by electric or cable power, or by dummy locomotives; also, to build street railways to connect with said belt line from terminal points now operated by street railway companies. The incorporators are E. E. Harbert, Frank E. Barker, John A. Taylor, and others.

**Rockford**—J. S. Ticknaugh, B. A. Knight and O. W. Haegg have incorporated the West End Street Railway company here with a capital stock of \$30,000. The company expect to commence work on three miles of electric railway at once.

## INDIANA.

**Goshen**—The Goshen Street Railway company has been organized, with \$25,000 capital, and it is proposed to connect the railroads, cemeteries and fair grounds by mule motive power.

**Kokomo**—The Kokomo Street Railway company has been incorporated, with a capital stock of \$100,000, by F. E. Baker, J. D. Oakford and W. B. Doods.

**LaFayette**—The LaFayette Union Railway company, of this city, has been incorporated, with a capital stock of \$150,000, to build a line seven miles in length. (A list of directors will be found under head of "Elections," in present issue.)

**LaPorte**—A street railway will probably be built here at once.

## IOWA.

**Creston**—A charter for the construction and operation of a street railway at this point has been granted to Regan Bros., of Omaha, and it is expected that construction along the line of the road will be commenced at once.

**Muscatine**—The Citizens' Electric Light company made application to the council for a franchise over certain streets. The Muscatine Street Railway company claims that it holds a franchise for twenty years, commencing in 1883, and protested against the granting of the application. However, the ordinance was granted as requested.

## KANSAS.

**Kansas City**—The city council here has passed an ordinance granting to Norton Thayer, of this city, and T. J. Enright, of Argentine, a franchise to construct and operate an electric street railway, beginning at the northern city limits and running through the central portion of the city and over the new Union & Pacific viaduct to Argentine. The ordinance provides that work must be commenced within three months, and the line be in operation within three months.

**Wichita**—The Wichita Electric Railway company, of Wichita, has been incorporated with a capital stock of \$1,000,000. (A list of the directors will be found under the head of "Elections," in this issue.)

## KENTUCKY.

**Winchester**—The Winchester Railway company has been organized for the purpose of building an electrical street railway here. (A list of the directors will be found under the head of "Elections," in this issue.)

## MARYLAND.

**Hagerstown**—An application has been made to the Hagerstown city council for the right to lay street car tracks upon the streets of the town.

## MASSACHUSETTS.

**Boston**—We understand that a syndicate has been formed here of Boston, Chicago and Texas capitalists for the purpose of buying and operating street railways. It is said that the following named gentlemen have been elected as offi-

cers of the company, which will have its general offices in Boston, with a branch office in Fort Worth, Texas. We understand that the capital stock of the company has been placed at \$500,000, with a bonded indebtedness of \$250,000. President, T. A. Hurley, Fort Worth, Texas; Vice-President, Nat. J. Rust, Boston, Mass.; Treasurer, J. Otis Weatherbee, Boston; Secretary, H. C. Butman. It is reported that the street railway systems of Austin and Gainesville have already passed into the hands of the syndicate, together with a portion of the Fort Worth system.

**Fall River**—We understand that the project is on foot for the construction of an electric railway in this city.

**Framingham**—The Framingham Electric Railway company has been incorporated. The length of the proposed road is to be about two and one-half miles, the gauge standard. Capital stock, \$30,000.

**Nantucket**—The Nantucket Street Railway company has been incorporated with a capitalization of \$60,000. (A list of the directors will be found under the head of the "Elections," in the present issue.)

**Natick**—The Natick Horse Railroad company is contemplating extending its tracks to South Natick and Framingham.

**Orange**—A franchise has been granted for an electric road between this point and Ottol.

**Whitman**—A franchise for an electric road between this point and Brockton has been granted and work will be commenced as soon as satisfactory arrangements can be perfected.

## MICHIGAN.

**Detroit**—A franchise for the extension of the Highland Park electric railway has been granted to Capt. Wm. H. Stevens, and the same party has also received a perpetual and exclusive franchise for a railway on Woodward avenue. It is believed that all this means a future probable extension to Orchard Lake.

**Menominee**—An electric railway will probably be built at this point in the immediate future.

## MINNESOTA.

**St. Paul**—The North Side Street Railway company, organized for the purpose of running an electric line to Robbinsdale has been incorporated here with a capital stock of \$500,000. The incorporators are J. M. Moan, of the Robinson & Moan car company, T. P. Walker and others.

## MISSOURI.

**Anaconda**—A franchise has been given by Marcus Daly and his associates for the construction and operation of the street railway at this point.

**Chillicothe**—An ordinance for the construction and operation of a street railway here has been granted to and accepted by Mr. W. J. Clark and his associates.

**Kansas City**—We understand that a belt line to connect Kansas City and Independence is to be built under the overhead system. It is proposed to construct nearly twenty miles of road.

**St. Louis**—The Vandeventer Avenue Railroad company has been incorporated by G. D. Capen, Edwoods Whitacre et al., with a capital stock of \$20,000.

**Webb City**—A St. Louis company has been organized to build a motor line here.

## MONTANA.

**Butte**—Articles of incorporation of the new electric railway company at this point have been filed, capital is placed at 3,000 shares, of par value of \$100 each. The incorporators are Chas. S. Warren, F. E. Sargeant, M. B. Brownlee, Wm. L. Hoge and Geo. W. Dickinson.

## NEBRASKA.

**Geneva City**—It is probable that the street car line will be built here at once.

## NEW HAMPSHIRE.

**Dover**—A survey is being made for an electric railway between Dover and Great Falls.

**Great Falls**—A project is on foot for the construction of the electric railway between this point and Dover.

**Manchester**—It is expected that an electric railroad will be built this season from Manchester to Lake Massabesic, a distance of about four miles.

## NEW JERSEY.

**Jersey City**—The Jersey City and Bergen Horse Railroad company has decided to operate all its cars by electricity. It is uncertain what system will be adopted.

**Plainfield**—A street railway is to be built here. The incorporators of the company are as follows: Jacob Kirkner, Dr. J. T. Fritts, T. A. Van Zandt, H. M. Du Flon, F. A. Dunham, J. N. Haywood, A. W. Platt, W. H. Kelley and J. H. Mooney.

## NEW YORK.

**Brooklyn**—The Union Ferry Street Railway company of this city has been incorporated with a capital stock of \$100,000, in order to construct and operate a road on Union street and from Hamilton avenue to 9th avenue and Prospect Park, a distance of two miles.

**Niagara Falls**—The Niagara River Street Railroad company, of this point, has been incorporated, with a capital stock of \$65,000. The length of the road when completed will be from six to seven miles. (A list of the directors will be found under head of "Elections" in present issue.)

**Pelhamdale**—Mr. Young, of New Rochelle, is the moving spirit in a project to connect this point with Travers Island and Pelham Bay with a horse car railway. It is expected that the scheme will be pushed through to completion.

**Syracuse**—The Syracuse Electric Railway company has been incorporated. (A list of the directors will be found under the head of "Elections" in this issue.)

**New York City**—The East & West Railway company, recently incorporated with a capital stock of \$300,000, will construct a road street railway company from corner of East 129th street and Second avenue, west through 129th street to Fifth avenue, to 135th street, to Edgecombe avenue, northerly along Edgecombe or New avenue to 142d street, through Bradhurst avenue to 155th street, to Harlem River; also from Eighth avenue and 155th street, northerly along Eighth avenue to 159th street and Harlem River. The length of the road is three miles.

**Saratoga**—We understand that the Saratoga Electric Railway company is to make some immediate extensions to its line.

**Tonawanda**—The project is on foot for the construction of an electrical railroad along the Niagara River road from here to connect with the line of the New Cross Town Street Railway company in Buffalo. (The news lacks confirmation.)

## NORTH CAROLINA.

**Hendersonville**—A street railway is being constructed at this point.

## OHIO.

**Cincinnati**—Word reaches us from Cincinnati that Messrs. George B. Kerper, Mooney & Lamont, all of this place, are interested in a project to run another rapid transit line from the heart of the city up to Walnut Hills. While we have not time to verify the information, we will say that the news hardly surprises us, inasmuch as one who has been so magnificently active in the promotion of street railway developments during many years past as has Mr. Kerper, it would be strange indeed if his restless soul could be kept out of the business.

**Cleveland**—A movement is on foot for the construction of an electric railway running from the Cleveland city limits down to Berea, a distance of about ten miles. The project is really in the hands of the prominent stockholders of the Berea Street Railway company. The cost of the road will necessitate the increasing of the capital stock of the Berea Street Railway company by some \$60,000. Nothing definite has, as yet, been decided upon.

**Columbus**—The question of an electric road on West Broad street has been revived and it is probable something will be done this week to determine when work shall begin.

**Fostoria**—The Fostoria Street Railway company, of this point, has been incorporated with a capital stock of \$50,000.

**Ivorydale**—The Ivorydale and Mill Creek Valley Railway company, of this point, has been incorporated with a capital stock of \$100,000.

**Marion**—The Marion Street Railway company has been incorporated with a capital stock of \$50,000. The incorporators are Hon. Warren P. Noble, Hon. J. T. Bunn, Samuel B. Sheath and



M. Trost, of Tiffin, and William Aye, of Marion.

**Staubenville**—The Market Street and Pleasant Heights Street Railway company has been incorporated with a capital stock of \$50,000.

**Uhrichville**—The Uhrichville and Dennison Street Railway company has been incorporated with a capital stock of \$30,000.

#### ONTARIO.

**Windsor**—We understand that the Detroit capitalists are negotiating for the right of way for the street railway on several streets at this point, while a company has been organized for the purpose of acquiring a franchise for the road between here and Walkerville.

#### OREGON.

**La Grande**—A twenty year franchise has been granted to parties here for a system of electric street railways, provisional upon the work being commenced within ninety days from March the 6th, and two miles of road must be in operation during this summer.

#### PENNSYLVANIA

**Beaver Falls**—An ordinance has been granted to the Beaver Falls College and Metamora Electric Street Railway company authorizing it to operate a street railway over certain streets in Beaver Falls.

**Philadelphia**—The Park Avenue and Carlisle Street Passenger Railway company, capitalized at \$30,000, and also the Tioga and Venango Street Passenger Railway company, capitalized at \$20,000, have been chartered.

**Pittsburgh**—The Post-Office and Schenley Park Passenger Railway company, of this city has been incorporated.

The Pittsburgh and Wilkesbarre Railway company has been granted the right of way over certain streets of the city. We understand it will parallel the Fifth avenue line and consequently will be a strong competitor of the same.

The Post-Office and Park Traction company proposes to build an electric street car line from the post office to Squirrel Hill. The capital stock of the company is \$36,000, and the stockholders are Maj. W. G. McCandless, James Breen, J. C. Alles, C. F. Jahn, M. F. Maloney and Mr. Bailey.

**Pittston**—A company has been formed here for the purpose of constructing an electric street railway from Wilkesbarre through this point to Scranton.

**Reddington**—The East Reddington Electric Railway company at a special meeting recently held, voted to increase its capital stock from \$50,000 to \$100,000.

#### TENNESSEE.

**Cumberland**—The Cumberland Street Railway company has been chartered by W. H. Simonds, J. L. Thomas, J. C. White, Sam B. Sittrell and W. L. Scott, all of Knoxville.

**Johnson City**—A street railway will probably be built at this point during the summer.

**Knoxville**—C. R. Walter, of Knoxville, M. M. Wilson and Engene Dedrick recently purchased a claim a little east of the city limits and have organized a street railway company for the purpose of running a street car line through the property. It will be operated as a real estate scheme.

**Rockford**—The Rockford Street Car company of this point has been incorporated.

A charter has been granted for a street car line to extend from this point to Cardiff and on to Harriman. H. H. Squair is president of the company, which latter is capitalized at \$15,000.

**Tazewell**—We understand that a company has been organized for the purpose of building a dummy line to the Knoxville, Cumberland Gap and Louisville railway depots, a distance of two miles.

#### TEXAS.

**Dallas**—A Dallas Electric Railway company has been incorporated with a capital stock of \$20,000. Among the incorporators are J. N. Dixon, A. W. Berlew and R. R. Vivian.

**Queen City**—Application for a charter for a rapid transit railway has been made by H. J. Allen, W. G. Wadley, Jr. and W. H. Wright, of this city, and Ed Rand, of Atlanta, Texas. The capital stock of the company organized is placed at \$10,000. Headquarters of the company are

to be here. (The names of the president and secretary will be found under head of "Elections" in present issue.)

**Sherman**—We understand that the street railway company here is about to build a belt line about seven miles in length.

A street railway will probably be built in a suburb of this city known as Fairview. Some prominent capitalists are interested.

#### UTAH.

**Salt Lake City**—We understand that an electric street railway will be built out to Terrace Heights, where an immense amount of property is owned by the Salt Lake City Improvement company. It will cost about \$40,000 to complete the road.

#### VIRGINIA.

**Hampton**—A new company has been formed to run a street railway between Hampton and Old Point. The incorporators are Dr. Selden, R. S. Hudgins, W. H. Mears, W. T. Gatewood and others. The new company proposes starting to build within ten days after the granting of the charter, and declare themselves ready to push the road to an early completion.

#### DISTRICT COLUMBIA.

**Washington**—A bill has been introduced in the house for the purpose of incorporating an East and West Washington Traction Railway company and District Columbia. The incorporators are James G. Berret, Archibald M. Bliss, Hamilton Disston, George S. Boutwell, Albert W. Fletcher, Joseph Clark, Samuel Cross, T. A. Duffy, E. C. Carpenter, H. A. Linger and William W. Repley.

#### WASHINGTON TERRITORY.

**Seattle**—A West Seattle Cable Railway company has been incorporated with a capital stock of \$50,000 for the purpose of building and operating street railways. (A list of the trustees of the company will be found under the head of Elections in this issue.)

Articles of incorporation have been filed by the Lake Washington Cable Railroad company for the purpose of building, equipping, operating and maintaining street railroads of every description, electric light wires and lines, etc. The capital stock of the company has been placed at \$600,000. (A list of the trustees will appear under head of Elections in present issue.)

The West Seattle Cable Railway company has been incorporated by Thomas Ewing, W. E. Bailey and J. F. Eshelman, all of Seattle; Homer King and G. W. Grayson. The capital stock is \$50,000, divided in 500 shares of \$100 each. The principal business of said company is to be in West Seattle.

**Spokane Falls**—The Spokane Falls East Railway company has been granted a franchise to run its line into the city, and it proposes to open a summer resort, running the street car line thereto. The distance will be in the neighborhood of sixteen miles. Steam will be adopted as motive power.

**Stevens**—A project is on foot for the formation of an electric railway and light company.

**Sprague**—This place is to have a new line of street cars and it is possible that electricity will be adopted.

**Tacoma**—A Tacoma Belt Railway company has been incorporated by William H. Cushman, George P. Eaton, Fremont S. Harmon, Elisha S. Callender, Eben Pierce, Allan B. Graham, Charles W. Whedon, Frank D. Nash and William A. Sternberg, of Tacoma, and Henry A. Strong, of Rochester, Monroe county, N. Y. The company is incorporated with the following objects: To construct, operate, build, buy, sell, lease and maintain street and other railways, operated by animal, steam, hydraulic, gravity or electric power, for the transportation of freight and passengers, to sell, lease, purchase land by gift or condemnation for all the purposes aforesaid, and to build, manage and run tugs and vessels and all manner of water craft. The capital stock is \$30,000, divided into 300 shares of \$100 each, duration fifty years.

#### WISCONSIN.

**Wauwatosa**—An electric street railway has been projected to run from Milwaukee to this point.

## ELECTIONS.

**Binghamton, N. Y.**—The officers of the new consolidated company which controls all the street railways here and is known under the name of the Binghamton Street Railway company, are as follows:

President—Jerome B. Landfield.

Vice-President—Gustav Stickley.

Secretary—Charles O. Root.

Treasurer—G. Tracy Rogers.

Officers and Directors—T. S. Rogers, George Whitney, J. H. C. Clark.

**Brooklyn, N. Y.**—At the annual meeting of the stockholders of the Vanbrunt Street and Erie Basin Railroad company the following officers were elected:

President—David W. Binns.

Secretary and Treasurer—Wyllys Terry.

Superintendent—F. A. Morrell.

Directors—D. W. Binns, Michael Murphy, Thomas J. Cunningham, Joseph F. White, Michael Coffey, Wyllys Terry and Benjamin F. Stebbins.

**Colorado Springs, Col.**—The Palmer Lake Street Car company has elected the following named gentlemen as directors:

J. L. Judd, E. C. Gard, S. C. Agnew, William Younger and T. A. Houks.

The officers of the Rapid Transit Electric Railway company here are as follows:

President—F. L. Martin.

Secretary—A. L. Lawton.

Treasurer—A. A. McGoveney.

Director's Officers—E. J. Eaton, M. A. Leddy.

**Grand Rapids, Mich.**—Senator S. Wesseling has been elected to the board of directors of the Kent County Street Railway company, vice D. H. Donovan.

**Knoxville, Tenn.**—At a recent meeting of the Knoxville Street Railway company the following named gentlemen were duly elected as officers for the ensuing year:

President—W. G. McAdoo.

Vice-President—F. K. E. Huger.

Secretary—S. G. Heiskell.

Manager—M. R. McAdoo.

**La Fayette, Ind.**—The following is a list of the board of directors of the recently incorporated La Fayette and Union Railway company:

Brown Brockenbrough, Edgar V. Burt, Samuel C. Curtis, Samuel Moore, James Buck, Oliver C. Goldsmith, Cyrenius Johnson, John Levering, James Murdock, James M. Reynolds, William Ross, Walter J. Ball and John P. Gagen.

**Louisville, Ky.**—At a recent annual meeting of the stockholders of the Louisville City Railway company, the old board of directors was unanimously elected.

At a subsequent meeting of the board of directors all of the old officers of the company were elected.

**Nantucket, Mass.**—The following named gentlemen constitute the board of directors of the recently incorporated Nantucket Electric Street Railway company:

J. A. Grant, P. A. Underwood, F. S. Pearson, J. Freeman, R. B. Hussey, H. Paddock and A. G. Brock.

**New York City, N. Y.**—The following named gentlemen were elected as directors of the recently incorporated Metropolitan Cross Town Railway company at the first annual election of same:

C. A. Winch, H. S. Mendelson, G. M. Law, A. B. Stone, A. J. Heyn, C. W. Smith and S. Barclay. At a recent election of directors of the Second Avenue Surface road of this city the following named gentlemen were elected to serve on the board:

George S. Hart, M. M. White, Samuel Knox, Edward C. Smith, Moses Mehrbach, Charles Brenneman, Noah C. Rogers, James L. Breese, Augustus S. Hutchins, Payson Merrill, Charles F. Cox, William E. Peck and Richard A. Anthony.

The inspectors of election for 1891 who were elected are Oscar Purdy, Henry H. Haight and William H. Payne.

The directors of the recently incorporated East & West Railway company of New York are as follows:

Lyman E. Minor, James W. Cragin, Elijah L.



Payne, Byron H. Searing, Samuel Barclay, Le-grand McKown and James A. Smith, all of New York.

**Niagara Falls, N. Y.**—The following named gentlemen have been elected as directors of the Niagara River Street Railroad company:

W. B. Rankin, New York; Charles B. Gaskill, Alexander J. Porter, H. Nielson, Lauren W. Pettibone, Henry S. Ware, David Phillips, Thomas Welch, Eugene Cary, W. C. Ely, Francis C. Belden, Niagara Falls; Henry Durk, Asher T. Cudaback, Suspension Bridge.

**Pittsburg, Kan.**—The Pittsburg Electric Railway company has elected the following directors: B. F. Hobert, Frank Playter, B. H. Wilson, F. A. Doubleday and A. E. Stillwell. The capital stock of the company is \$50,000.

**Pittsburg, Penn.**—At the eighteenth annual meeting of the Pittsburg and Castle Shannon Railroad company the following named gentlemen were elected as officers for the ensuing year: President—Walter Chess.

Directors—Jacob Geib, L. S. McKallip, James M. Bailey, W. H. Brunt, P. F. Schuchman, Jas. R. Redman, H. Dana Rolfe, Charles Zugsmith, Jr., Thomas Mellon, J. M. Conroy.

**Pueblo, Col.**—The new board of directors of Pueblo City Railway company consists of A. W. and F. J. Chamberlin, J. T. Vail, J. E. Downey and J. B. Warman.

**Queen City, Texas.**—The following named gentlemen constitute the executive of the recently organized street railway company:

President—H. J. Allen.  
Secretary—Ed. Rand.

**Salt Lake City, Utah.**—At a meeting of the directors of the street railway company, which was held on the 18th of last month, the resignations of Frank Armstrong, president and director, and Henry Dinwoody, vice-president and director, were accepted. A. W. Coon was elected president, and R. C. Chambers vice president and director. Mr. Baker, of the Bank of Salt Lake City, was elected director.

**Seattle, Wash. Ter.**—The following named gentlemen constitute the board of trustees of the recently incorporated Lake Washington Cable Railroad company:

Fred E. Sander, Henry K. Hall and Louis D. Bruns.

The following named gentlemen have been constituted a board of trustees of the West Seattle Cable Railway company, recently incorporated at this point:

Thomas Ewing, H. G. Struve, W. E. Bailey, J. E. Eshelman, W. C. Hill, Homer S. King and George W. Grayson.

**Syracuse, N. Y.**—The Syracuse Electric Railway company has elected the following named gentlemen as directors for the ensuing year:

Henry F. Stephens, Abraham D. Sanford, Michael Whelan, Charles Johannot, Riley V. Miller, Iram C. Reed and Thurston D. Brewster.

**St. Joseph, Mo.**—At the recent annual meeting of the stockholders of the Union Line Street Car company the following named gentlemen were elected as directors for the ensuing year:

James Craig, Jr., A. Steinacker, John Houck, Louis Steinacker, Henry Krug, Sr., Charles F. Ernst, Seymour Jenkins and William Krug.

**Wichita, Kan.**—At a recent meeting of the Wichita Electric Railway company the following gentlemen were elected to constitute the board of directors:

J. O. Davidson, Thos. G. Fitch, George L. Rouse, B. H. Campbell and C. A. Walker, all of Wichita.

**Winchester, Ky.**—The following named gentlemen have been elected as directors of the Winchester Railway company, recently organized:

N. H. Witherspoon, Claiborne Lise, J. D. Simpson, H. P. Thompson, Thomas G. Stuart.

**Weymouth, Mass.**—The board of directors of the Weymouth and Hingham Street Railway company are as follows:

J. S. Cushing, P. M. French, J. A. Fogg, J. A. Burdett, George Cushing, J. W. Hart, John Carroll and W. A. Stiles.

The May issue of the GAZETTE will contain a large amount of street railway news from all quarters of the globe.

## EXTENSIONS.

**Auburn, Me.**—We understand that preparations are now being made for the establishment of a big water power plant at Veazie, to furnish power and light as far as Oldtown.

**Bangor, Me.**—The Bangor Electric Railway is to be extended in the spring, when about eight miles of new track will be laid.

**Bay City, Mich.**—The Bay County Electric Light company has decided to extend its line up Broadway on 29th st.

**Dubuque, Iowa.**—The Key City Electric Street Railway company will extend its line over all the remaining right of way of the company in the immediate future.

**Knoxville, Tenn.**—A Knoxville Street Railway company has decided upon more extensions and improvements, and it is reported that nearly \$200,000 will be expended on the work.

**Lebanon, Pa.**—The Lebanon Electric Railway company will extend its line to Myerstown and Annville, a total distance of about fifteen miles.

**Lima, Ohio.**—We understand that the Main street line of the street railway here will be extended for a distance of one mile during the spring.

**Lockport, N. Y.**—The Lockport Street Railway company will probably extend its lines some three miles this spring.

**Milwaukee, Wis.**—The Cream City Railroad company will extend its tracks at once.

**Mobile, Ala.**—The Mobile Street Railway company will extend its line at once.

**Moline, Ill.**—The Moline and Rock Island Horse Railroad company has been granted permission for the extension, etc., of its line.

**Muscatine, Iowa.**—We understand that the Muscatine Street Railway company will extend its line at once.

**Newburyport, Mass.**—The Salisbury and Newburyport street railroad is to be extended to Seabrook, New Hampshire.

**New Britain, Conn.**—The Street Railway company of New Britain is about to extend its lines in the eastern sections of the town.

**Newark, N. J.**—At a recent meeting of the council, the Essex Passenger Railway company obtained a franchise to extend its lines at Crosstown in the upper part of the city.

**New Brunswick, N. J.**—S. A. Clark, of Elizabeth, has been appointed superintendent of the New Brunswick Street Railway company.

**Pierre, Dak.**—The street railway system here is being extended.

**Poughkeepsie, N. Y.**—The Poughkeepsie Railroad company will extend its lines in the immediate future.

**Saginaw, Mich.**—We understand that the Saginaw Union St. Ry. Co. will extend its electric car service to the west side; the owners of the Bristol St. bridge refused the railway company permission to permit electric cars to cross the bridge, so the company turned around and bought it.

**Salt Lake City, Utah.**—As predicted some time ago in the GAZETTE, the street railway company here is about to adopt electricity as a motive power, and to make some immediate extensions along its lines.

**St. Louis, Mo.**—The St. Louis Cable and Western Railway company will extend the Locust Street cable line to Forest Park, and use electricity as motive power.

**Springfield, Mass.**—It is reported that the street railway company will extend its line at once.

**Topeka, Kan.** We understand that the Rapid Transit Railway company will extend its road at once.

**Toledo, Ohio.**—We understand the Toledo Electric Railway company will be extended at once.

**Worcester, Mass.**—It is possible that the street car line here will be extended in the near future.

A. S. R. A.

OFFICE OF  
THE AMERICAN STREET RAILWAY ASS'N,  
BROOKLYN, N. Y., March 26, 1890.  
THE STREET RAILWAY GAZETTE, Chicago, Ill.  
GENTLEMEN—The following is the list of

Special Committees to report at the Ninth Annual Meeting of this Association, to be held in Buffalo, N. Y., the third Wednesday in October, 1890:

A Perfect Street Railway Horse.—Charles Odell, Pres. Naumkeag Street Ry. Co., Salem, Mass.

A Year's Progress of Cable Motive Power.—James C. Robinson, V.-Pres. Los Angeles Cable Ry. Co., Los Angeles, Cal.

Electric Motive Power Technically Considered.—Dr. W. L. Allen, Pres. Davenport Central Ry. Co., Davenport, Iowa.

Novel Schemes for the Development of Street Railways.—Benjamin F. Owen, Pres. Reading City Pass. Ry. Co., Reading, Pa.

Public and State Treatment of Corporations.—No. 2.—G. Hilton Scribner, Pres. Central Park, North and East River R. R. Co., New York, N. Y.

Sincerely yours,

WM. J. RICHARDSON, Sec.

OFFICE OF

THE AMERICAN STREET RAILWAY ASS'N.  
Brooklyn, N. Y., April 5, 1890.

*The Street Railway Gazette, Chicago, Ill.*

GENTLEMEN:—The following is an extract from the report of the executive committee at the regular meeting of the association, held at Minneapolis, October 16-18, 1889.

THE COLUMBUS EXPOSITION.

Your Committee considers it wise to bring to the notice of the association the fact that somewhere in the United States a grand World's Fair will be held in 1892; and to suggest that a committee, sufficiently extensive as to territory, shall be appointed to secure for the street-railway industry an exhibition commensurate with, and fully illustrative of, the business."

The association appointed the following gentlemen the World's Fair Committee:

George W. Pearson, Washington, D. C.  
G. Hilton Scribner, New York, N. Y.  
Charles B. Holmes, Chicago, Ill.  
E. B. Edwards, Philadelphia, Pa.  
Henry M. Whitney, Boston, Mass.  
Thomas Lowry, Minneapolis, Minn.  
Charles Green, St. Louis, Mo.  
Edward Lusher, Montreal, Can.  
William H. Martin, San Francisco, Cal.  
George B. Kerper, Cincinnati, O.  
William J. Richardson, Brooklyn, N. Y.

It is confidently expected that the street-railway exhibit under the auspices of The American Street-Railway Association will be one of the most interesting at the exposition.

### Winter Work of the Thomson-Houston Company.

The Thomson-Houston company recently closed a contract with the Augusta, Hallowell & Gardiner Railway company, of Augusta, Me., for three motor cars and an equipment of three miles of track. The construction work will be commenced as soon as the condition of the ground will permit of the setting up of poles, and it is expected that the road will be in operation early in the spring.

A contract has been closed by the Thomson-Houston International company with the Bremen Tramway company, Bremen, Germany, for six motor cars, and two miles of electrical equipment.

The Citizens Street Railway Co., of Indianapolis, Ind., has contracted for six and one-half miles of equipment and ten motor cars.

A contract has also been closed at Pueblo, Col., with the Pueblo City Railway for ten motor cars. The overhead construction will be used throughout on this line, which comprises a total of 21 miles of rack.

A contract has also been closed at Port Townsend, Wash., with the Port Townsend Street Ry. Co., for three cars. The line is three miles in length, and the overhead construction will be used.

The Rockford Street Ry. Co. has also closed a contract for a line (overhead construction) of six and three-fourths miles in length and an equipment of seven motor cars.

The South Bend & Mishawaka St. Ry. Co. has



closed a contract for an electric railway at South Bend, Ind. The line will be eight miles in length (overhead construction) and six motor cars will be used.

A contract has also been closed with the Springfield City Ry. Co., Springfield, Mass., for a line of two miles in length, on which six cars will be operated.

A contract has also been closed at Springfield, Ill., with the Springfield City Ry. Co. for eight motor cars, and an equipment of seven miles of track (overhead system).

A contract has also been closed with the Toledo Elec. Ry. Co., Toledo, O., for an equipment of 17 miles of track, and 25 motor cars, in addition to the two and one-half miles and three motor cars already in operation there. With the additions the road will have 28 motor cars, and 19½ miles of track electrically equipped.

The Winona City St. Ry. Co., Winona, Minn., has also closed a contract for five motor cars, and four miles of track, and the Douglas County St. Ry. Co. for the same length of track and two motor cars.

A contract has also been closed at Shreveport, La., for four motor cars, and four miles of track.

These contracts aggregate 114 motor cars, and 107.05 miles of track.

**Business Mention.**

W. B. Knight, of Kansas City, has recently placed a contract for the electrical equipment of the Augusta Railway, at Augusta, Ga., with the Sprague company, of New York City. The contract embraces fourteen miles of overhead construction and sixteen motor cars, which will be equipped with double 30 h. p. motor trucks.

The open motor cars are to be built by the Robinson & Moan Car Co., of Minneapolis, and the closed cars and motor trucks by the J. G. Brill Co., of Philadelphia. Mr. Knight is also preparing plans and specifications for a power station, which will be a brick building 95 x 145, and which will contain two 80,000-watt Edison generators, car storage for twenty-four cars, car pits, machine shops, and everything necessary for a power station, together with offices for the company itself. He is also designing a water power plant of 500 h. p., which the company expect to use for regular service, in addition to which he is putting in an auxiliary steam plant, consisting of 150 h. p. Babcock & Wilcox boilers and 150 h. p. New York Safety High Speed Automatic Engine. It is intended that the steam plant will be put in first and used while the water power plant is being arranged for, and for service during periods of high water or interruption to the water power from any cause. The contracts for the rails to be used on the line have been placed with the Waugh Steel company, of Belleville, Ill., and the Wm. Wharton, Jr. Co., of Philadelphia. Track laying has already been commenced, and will be pushed through to completion, and it is expected that cars will be running on one of the three lines by the first of June.

The Kansas City & Blue Valley Railway Co. has recently closed a contract with Mr. Knight for the equipment of its electric line, which will be double track, with centre pole overhead wire construction, and which will be operated under the Thomson-Houston patents. When completed, the road will be about two and one-quarter miles long, and will be supplied, for the present, with four double 30 h. p. motor trucks. It is expected that the road will be in operation by September.

The following is self-explanatory :

OFFICE OF  
BRODERICK & BASCOM ROPE CO.,  
ST. LOUIS, MO., Jan. 3, 1890.

Mr. John Walker, Esq., Cleveland, O.:

DEAR SIR—In reply to your favor of 26th inst., would say that from my observations of the Walker Differential Drum system, I believe it to be not only the best, but the only proper system of driving drums for cable road purposes now in use. Next to the cable, the driving drums are the most important feature of a cable road plant as regards the life of a cable, for no cable, to do effective work, should be allowed to make any more bends, and undergo any additional strains due to unequal wear in the grooves, than can be

absolutely avoided. The solid drum system, as now in use on most roads, has a very serious defect—that of putting an unequal strain on the cable by the unequal wear in the grooves, consequently stretching and breaking up the wires much sooner than they would if the grooves were kept the same depth throughout. Where the grooves of driving drums are badly worn, it not only has a bad effect on both cable and machinery, but is very often the cause of a cable stranding at the splice on account of the unusual strain on the cable at that point. I have seen frequent instances on various roads where the grooves varied in depth from ⅛" to ¼", and, in the latter case, the ordinary knot splice could not be made to remain intact, and the difficulty was only remedied by moving the cable to the grooves on that part of the drum that had not been previously used, and which had the effect of immediately stopping the trouble. A cable should not be run with any more wraps on the drums than is absolutely necessary to do the work, as every wrap means four bends to the cable, and every additional wrap means four added bends, which has a very injurious effect after the cable has become partly worn, due to abrasions caused by grips, wear, etc. The proper method to obtain the minimum number of wraps to do the work without slippage is to gear the drums together, thereby increasing the driving efficiency of the drums 100 per cent. over the present method of many roads, who use only one drum as a driver and the other as an idler or carrying drum. A decreased number of wraps not only insures a longer life to the cable, but also lessens undue strains and wear and tear on the machinery plant, thereby making it much more economical as regards repairs and fuel. I have known one single wrap added to driving drums, when cable was running empty, to increase the load on the engine by over fifteen indicated horse power. In this instance the grooves were very badly worn. From what I have seen of your system in operation in St. Louis (at St. Louis Cable & Western Ry. Co.), I am convinced that it accomplishes all that you claim for it as regards lessening the strain on the cable and increasing its life, and I would not hesitate to advise any road to adopt your system, as I am satisfied that with proper and intelligent care of the cable that it would add a very large per cent. of life to it.

Very truly yours,

EDWARD P. FREDERICK,  
Supt. Broderick & Bascom Rope Co.

W. R. Mason, late of New York City, has associated himself with the Sprague Electric Equipment company, Chicago, as general sales agent.

The following is an extract from a letter written to the Sprague Equipment company by James F. Peavey, President Sioux City Street Railway company:

"I am more than pleased with our electrical construction all the way through, which is of such a character that you and all connected with the Sprague Electric Equipment company can point to it with much pride, and I believe it will prove not only satisfactory to us but also profitable."

The Walker Manufacturing company has secured the contract for the driving machinery for the Cleveland City Railway Co. The Walker differential drums will be used.

A. L. Ide, of Springfield, Ill., recently closed a contract for two 150 h. p. "Ideal" engines for the Fort Worth Land and Street Railway company, of Fort Worth, Texas.

PULLMAN'S PALACE CAR CO.,  
Chicago, April 8, 1890.

THE STREET RAILWAY GAZETTE, Chicago, Ill.:

GENTLEMEN:—In accordance with your request, we beg to advise you that among the orders recently taken by us for new street railway equipment, are the following :

Closed motors (Thomson-Houston system) for the Douglas County Street Ry. Co., West Superior, Mich.

Excursion equipment (steam motor) for the Willamette Bridge Ry. Co., Portland, Oregon.

Sixteen closed cars for street railway service,

(steam motor), for the Point Defiance Ry. Co., Tacoma, Wash. Ter.

Open motor cars (Sprague system) for the Metropolitan Railway Co., Portland, Oregon.

Open and closed motors (Sprague system) for the Colorado Springs Rapid Transit Railway company, Colorado Springs, Colo.

Open horse cars for the Toledo Consolidated Street Railway company, Toledo, Ohio.

Closed motors (Thomson-Houston system) for the Green Lake Electric Railway company, Seattle, Wash. Ter.

Closed motor cars (Sprague system) for the Capital City Railway company, Salem, Oregon.

Closed motor cars, Joliet City Railway company, Joliet, Ill.

Open and closed motors (Sprague system) for the Passenger and Belt Railway company, Lexington, Ky.

Open motors (Thomson-Houston system) for the Omaha and Council Bluffs Railway and Bridge company, Council Bluffs, Ia.

Closed motors (Sprague system) for the Federal Street and Pleasant Valley Passenger Railway company, Pittsburgh, Pa.

Open motors (Sprague system) for the Laredo Improvement company, Laredo, Texas.

Trail cars (Sprague system) for the Laredo Improvement company, Laredo, Texas.

Closed motors (Sprague system) for the Moline Central Street Railway company, Moline, Ill.

Open motors (Sprague system) for the Sioux City Street Railway company, Sioux City, Iowa.

Open and closed motors (Thomson-Houston system) for the Helena Electric Railway company, Helena, Montana.

Closed motors and open trail cars (Sprague system) for the Chamberlain Investment Co., Fort Worth, Texas.

Open and closed motors (Thomson-Houston system) for Spokane Falls, Wash. Ter.

Closed motor (Thomson-Houston) for Port Townsend, Wash. Ter

Closed motors (Thomson-Houston system) for Portland, Oregon.

Closed excursion car (steam motor) for the Bay Railway company, Astoria, Oregon.

Closed motors (Sprague system) for the Tacoma Railway and Motor company.

Closed motor (Sprague system) for the Willamette Bridge Railway Co., Portland, Oregon.

Closed motor and open trailers (Sprague system) for the United Electric Railway company, Nashville, Tenn.

Open trail cars (Thomson-Houston system) for the Knoxville Street Railroad company, Knoxville, Tenn.

In addition to the above, we are building for the Duquesne Traction company, Pittsburgh, Pa., sixty double truck electric cars, which are to be equipped with the Thomson-Houston system. These cars are 29 feet long, with the cab at the front, and platform at the rear, and are mounted on double trucks, which are equipped with steel tired wheels and vacuum brake. The motors are placed one upon each truck.

We are also under contract to build for the Elmer A. Sperry company, a 26 foot motor car, which is to be mounted upon double trucks and equipped with the new Sperry motor. The motor on this car, however, is hung from the centre of the body and not on the trucks as is usually the case.

Yours truly,  
C. L. PULLMAN,  
Contracting Agent.

CHICAGO, March 6, 1890.

THE STREET RAILWAY GAZETTE, Chicago, Ill.:

GENTLEMEN—With pleasure we beg to notify you that we have become incorporated under the old name of "Blomgren Bros. & Co."

As the name remains unchanged, so does the personnel of the concern. In the new company, Oscar N. Blomgren is the President; Claus G. Blomgren is Vice-President; John Soderberg, for the past thirteen years bookkeeper for the firm, is Treasurer; and Jos. H. Barnett, who has been with the firm for eleven years, is Secretary and Manager.

Those of our customers with whom we have had pleasant relations so long will find us making the same efforts to excel in every department, and can continue their patronage with the utmost confidence. As our trade demands, we shall make such increase in our facilities as will enable



us always to do the best work in the shortest time.

We thank you for the patronage heretofore extended us, and cordially invite you to continue the same. Whenever you need electrotyping, stereotyping or engraving, either process or wood, please call upon us, as our future aim will be to maintain the same pleasant relations with our customers that have been experienced in the past.

Respectfully yours,  
BLONGREN BROS. & Co

The Union Passenger Railway Co., of Chester, Pa., has awarded the contract for the building of its new road to the Equitable Electric Railway Construction Co., of Philadelphia, and as soon as the thirty days' injunction is off work will be started. This new road will run from one end of Chester to the other, and will start with five 30 h. p. cars. A Wetherill Corliss engine will furnish the power for the generators, and the road will be laid with Johnson rail.

The Wilmington City Electric Railway Co., Wilmington, Del., is connecting its Eighth Street road with its Riverview Extension, by building the three intervening squares on Market street. Besides, it is erecting its own power station, which when completed, will be a very extensive and complete plant. It will consist of three 150 h. p. Westinghouse compound engines, and six 50,000-watt Edison generators, with the necessary boilers, etc. Additional car equipments have been ordered, and when all the improvements will have been made, Wilmington will have a very complete electric railway system. All the work is being done by the Equitable Electric Railway Construction Co., of Philadelphia.

The Southwark Foundry and Machine Co., builders of the Porter Allen high speed engines, is about putting in their new foundry, two Sellers improved traveling cranes, of 50 tons capacity each, each crane being driven by a 35 h. p. Sprague motor. A 50,000-watt generator, situated in another part of the works, will

furnish the necessary power, and the whole plant is being installed by the Equitable Electric Railway Construction Co., of Philadelphia.

The East Reading Electric Railway Co., Reading, Pa., is extending its line from 19th and Perkiomen streets to 9th and Penn streets, a distance of 9,000 feet. This brings it to the centre of the town, and will add greatly to its traffic. It has ordered two new 30 h. p. Sprague equipments, and is changing all its old 15 h. p. equipments, which will give it six new 30 h. p. cars, and will make this railway one of the best equipped electric railways in the country. Mr. A. J. Brumbach, the president, takes a great deal of pride in his road. All the above work is being done by the Equitable Electric Railway Construction Co., of Philadelphia.

The North Avenue Electric Railway, of Baltimore, Md., which is being built by the Equitable Electric Railway Construction Co., of Philadelphia, will be the only electric railway in the City of Baltimore that has ever been granted an overhead franchise. The road is being built under the "Sprague system," and is about 2 miles long, and will start with two cars. The current will be furnished from the Brush station about 2 miles distant. The road will be in operation on the 15th of April.

The Equitable Electric Railway Construction company has closed a contract, with the owners in Philadelphia, for the electrical equipment of the Quincy, Ill., Street Railway. Ten cars, each equipped with two 15 h. p. Sprague motors, with the necessary generating plant, will be installed at once. The McLaughlin storage battery will be used.

Reviews.

We find lying on our desk a copy of the initial number of the *Western Engineer*, published by the Pond Engineering company. It is a well gotten up paper, and contains information of value and use to engineers and parties interested in the generation of steam and transmis-

sion of power. We understand that a copy of the paper will be sent to any one upon application to the Pond Engineering company, St. Louis, Mo.

Obituary.

It is with unfeigned sorrow that we have to record the demise of Mr. H. A. Glasier, the Chicago partner of J. A. Grant & Co., who died very suddenly of heart failure at 5 o'clock, on the morning of April 15.

Mr. Glasier was well known to all in the electric, steam and railway fields, and his unflinching good nature, his open, straightforward manner, and his many manly qualities made him universally beloved, and his death will be deeply regretted by all who knew him.

The deceased was born in Johnsbury, N. Y., Jan. 7, 1840, of Scotch-French parents; he spent many years of his life on a farm, and entered the 64th Regiment Volunteer Infantry of Mass. as private upon the breaking out of the war. He won his military title of captain on the field of battle, by conspicuous bravery, and at the close of the war interested himself in mercantile pursuits, and was Vice-President of the Jarvis Engineering company, of Boston, prior to his connection with J. A. Grant & Co. For a week or so previous to his death, Mr. Glasier had been working very hard to secure some large orders, and the consequent excitement is supposed to have been somewhat instrumental in hastening his death.

He leaves a wife and two sons to mourn his loss, and the "GAZETTE" begs to assure them of its heartfelt sympathy in their sad bereavement.

FOR SALE.

SUBJECT PRICE SALE—Have 3 Baldwin and 3 Porter Motors various sizes; 7 Steam Motor Cars, together with a number of Horse Cars, and 750 tons 40-lb. Steel Rails.

HORACE A. KEEFER, KANSAS CITY, MO.

FOR SALE.—Two 1H, 1K, Porter Standard Gauge Dummies; One Baldwin Engine and Car Combined, at a very low price. For particulars address THE RIVERSIDE AND SUBURBAN RAILWAY CO., WICHITA, KANSAS.

IT BELTS THE EARTH AND MAKES THE MOON SPIN LIKE A TOP.

OUR BELTING IS TANNED ON THE SURFACES ONLY. INTERIOR IS RAWHIDE. The only Perfect Belt made. No slipping or lost motion.

ST. LOUIS, MO. AGENTS IN ALL CITIES

**JAMES A. TRIMBLE,**  
MANUFACTURER OF  
**RAIL ROAD CAR WOOD WORK,**  
Plain and Carved Mouldings, Doors, Sashes, Blinds, Pillars and Sills, all patterns.  
**Nos. 220 & 222 EAST 28th STREET,**  
Between 2d and 3d Aves.,  
**NEW YORK.**

**CELLULOID RAILWAY CHECKS,**  
THE BEST SUBSTITUTE FOR SMALL CHANGE.  
LIGHT, HANDSOME, DURABLE.

SEND FOR PARTICULARS TO  
CELLULOID NOVELTY CO., 313 & 315 Broadway, NEW YORK

**Southwestern Electrical Engineering Company**

AGENTS FOR . . .

- The Brush Electric Co.
- The Short Electric Ry. Co.
- The Simplex Electrical Co.
- The Swan Lamp Manf'g Co.

**ELECTRICAL ENGINEERS AND CONTRACTORS**

BUILDINGS WIRED AND ELECTRICALLY EQUIPPED.

**ELECTRIC RAILWAY CONSTRUCTION A SPECIALTY.**

**515 WALNUT STREET, ST. LOUIS, MO.**



# The Street Railway Gazette.

(Copyrighted, 1890.)

Vol. V.

CHICAGO.

MAY, 1890.

CHICAGO.

No. 5

## 80 H. P. Generator.

In electric railway power stations the apparatus is of the greatest importance, and that on which the successful working of the car depends is the dynamo, or generator, usually called. Such a machine must be of the best quality, both in design and construction, and fully capable of supplying a current at a uniform potential under all changes in load which are met with in electric railway operations. A machine of such description is shown in the accompanying cut, the Thomson-Houston 80 h. p. Motor Type Generator, which has been extensively used for street railway work, and has proved to be particularly suited to this field of electrical engineering. As its name implies, it is similar in form to the well known Thomson-Houston Motor, and has, too, many of the same features found in the machines used for lighting purposes. The company is now engaged in building railway generators of 100 and 250 h. p., which are demanded by the magnitude of its operations in the direction of electric street railway work.

## Rochester Railway.

In the construction and electrical equipment of this line, on the Short electric system, the engine house will be in the center of the system, on the lower falls of the river. From this the lines radiate in every direction, taking in the entire city and extending in several directions out of the city.

This station is to be located on the site of the old passenger depot of the New York Central R. R., on a piece of land about 120 x 250 feet, bounded on two sides by streets, on the third side by the railroad tracks, and on the fourth side by Brown's race, which furnishes water for condensation.

A new building especially designed for convenience is to be erected, and Heine Safety Boilers of 1,500 horse power (water tube) are to furnish steam at 125 pounds pressure.

The engines will consist of three triple expansion engines of 300 h. p. each, three single cylinder engines of 150 h. p. each, and one single cylinder engine of 60 h. p., furnished by The Ball Engine company.

An independent Worthington condenser will be used, also Worthington boiler feed pumps. Each of the triple expansion engines is to drive two generators, and the single cylinder engines each one.

The independent condenser will be com-

pany has followed the best practice, and bought eleven small generators instead of a few large ones (100 h. p. generators of the improved Bru-h type.) Ten cars will be operated from each generator, leaving one in reserve for emergencies. The switch board and station appliances will show some important advances in this line of apparatus, which will be described later on.

"The silent motor" will be used, two 15 h. p. motors to each car. Both the truck and the car body are to be modified to admit of the easiest possible adjustment of the motors, which, under the new arrangement, can be reached from any point under or in the car, and a novel method of car lighting, to be described later on, will mark a long step in advance of the present discomfort and inadequacy.

The road is to be in operation by July 1st, and track wiring has been commenced. Steel and octagon poles are to be used. The motor armature weighs 198 lbs., and has a very gentle movement at starting, stopping or when the car is traveling at a crawling rate of speed. One of the important features of the motor is an almost entire lack of noise, in consequence of the use of insulated gears, a system of wooden insulation being used. The weight of the

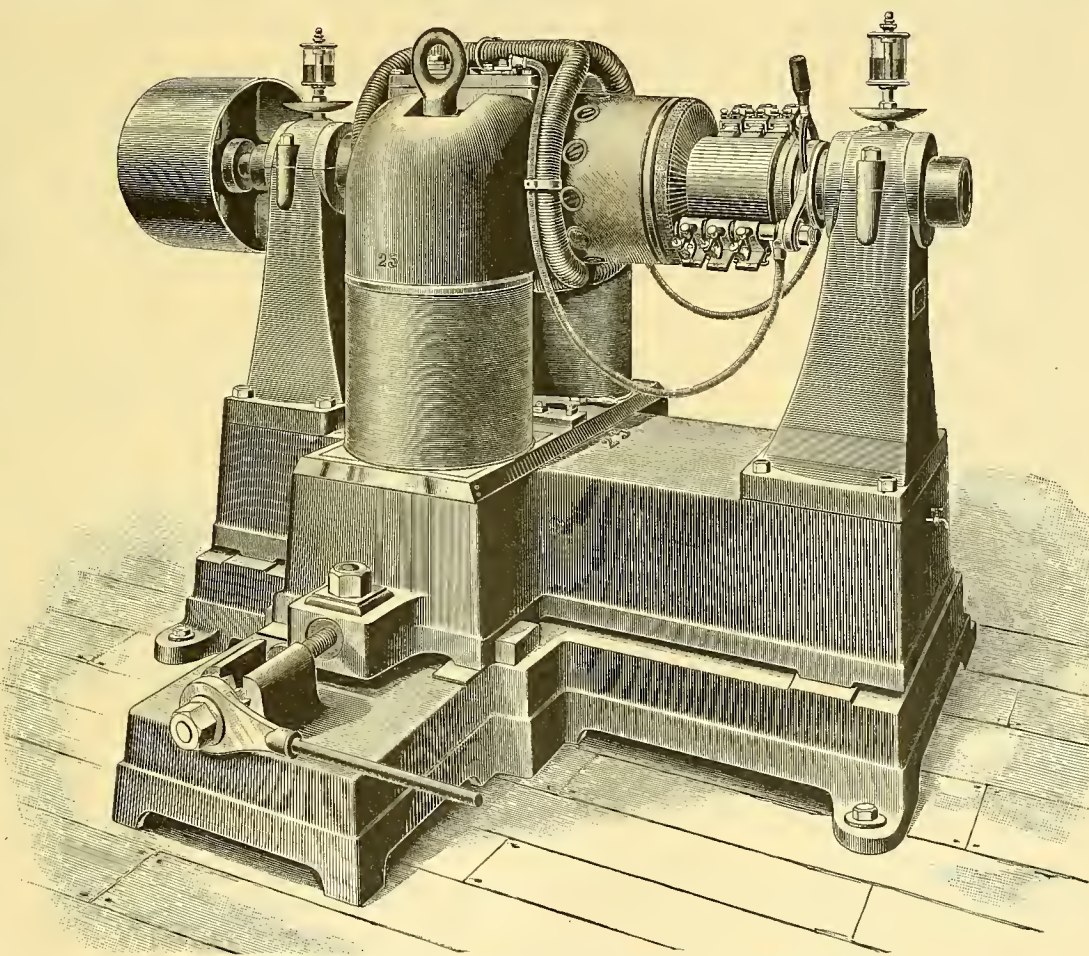

THE THOMSON-HOUSTON 80 H. P. MOTOR TYPE GENERATOR.

pounded with the low pressure cylinder of the engines, and all the arrangements of the station are intended to be of the very latest that can be obtained.

The general design of these triple expansion engines will be of the cross compound type, with tandem cylinders, using four cylinders, a high and a medium pressure cylinder being placed tandem with the low pressure cylinders, the steam expanding from the high pressure to the medium pressure cylinders, and thence to two low pressure cylinders.

It is expected to develop a horse power on 1.75 pounds of coal.

In fitting out the power station the railway

motor—which is secured to the truck by six bolts—is 1,787 lbs. The armature can be removed by two men in less than ten minutes; it runs 1,000 revolutions per minute. The cars are to be furnished with an electric brake, thus ensuring a high degree of safety. The cars will be equipped with Peckham's cantilever truck, slightly changed with regard to the motor hanger in order to conform to the requirements of the Short motor.

In this truck, which is being very generally adopted by prominent electric railways, the elements of strength and ease of motion enter largely into its construction, and in every case where it has been adopted it has given complete satisfaction to the operating company.



### Car Heating.\*

It is very generally admitted that the question of heating street cars will allow of almost as much reform as has taken place, during the last few years, in heating steam railroad cars.

The requisites of a perfect form of heater or system of heating for street cars are too numerous to admit of much discussion here, but we believe that the principal objects to be attained are:

- { "Comfortable and uniform temperature.
- { "Safety and cleanliness for the passengers.
- { "Economy and simplicity of operation.
- { "Utility of space."

The coal stove hardly fills the bill; but there is a system on the market that has been tried on the North Hudson County Street Railroad, N. J., and the Hoboken, N. J. cable cars, which certainly merits the consideration of street railroad men on account of its unique and almost perfect completeness in fulfilling the foregoing requirements, and of which the following is a brief description:

In this system, a cylinder or "storage heater" runs down the full length of the car under each seat; and absorbs sufficient heat, when charged with steam at the depot, to keep the car comfortably and uniformly warm for one journey of three or four hours.

The distinctive feature is called the storage heater (see figures 1 and 2). It consists of two wrought iron boiler tubes, the one within the other. The smaller and enclosed cylinder is filled with a strong solution of salt water to seven-eighths, of its capacity, thus allowing room for expansion. It is hermetically closed at both ends and thus the solution is maintained at a constant strength; it can not freeze, and never needs replacing. This smaller cylinder rests on small supports "H," leaving an annular space "C" as a steam chamber.

The outer cylinder is fitted with caps leaving sufficient space at each end to allow for expansion of the smaller cylinder. The caps are tapped for pipe connections, the steam entering the chamber "C" at one end, and the water of condensation escaping at the other.

Upon the admission of steam into the chamber "C," the outer cylinder at once begins radiating heat, and at the same time the smaller cylinder is absorbing heat; so that when the steam is shut off, the heat stored, passes by conduction to the outer cylinder and thence radiates into the car, keeping the temperature uniform for several hours.

The cylinders are so placed that the passengers' feet can not touch them; and are protected by wire mesh.

It is necessary to have facilities for supplying steam to charge the heaters once every two or three hours; this can be done at termini of route or in depot yards.

A coupling is fitted at each end of the car, for making connections with steam supply, and returning water of condensation to boiler in which case there is no waste, and the nuisance and danger of the waste water freezing in the depot yard or in the car house is thereby avoided.

When steam pressure is taken off, and the connection broken, a check valve in the body of the coupling closes.

There is also a cock at each end of the car which can be used if necessary, these close the heaters and prevent the escape of steam, until all the heat is absorbed. Then the remaining water of condensation escapes through an automatic relief trap which is also in the coupling which opens immediately pressure is reduced.

The following figures are taken from some tests made in Hoboken on a car doing a round trip in one hour:

Steam Pressure—80 lbs.  
Duration of one charge.—1 1/2 m.  
Outside temperature.—39 deg.  
Temperature of car after first charged.—55 deg.  
Number of hours run—6 1/2.  
Number of charges—3.  
Average inside temperature—56 deg.  
Weight of water condensed—18 lbs.

It will be seen that the stored heat was sufficient to raise the temperature of the car on an average one degree higher than when first charged, showing how completely the storage was effected.

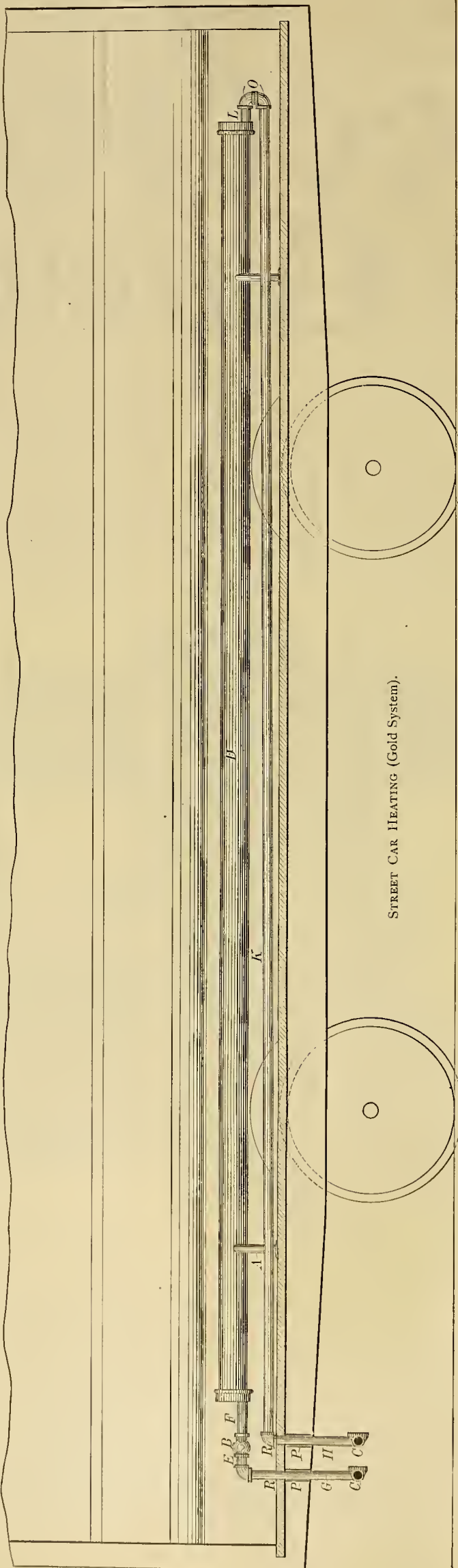

This and other experiments where but one heater was used in the car, showed that to maintain a uniform temperature of 53 degrees in a car for twenty-two and a half hours, 126 pounds of steam were condensed, requiring the consumption of fourteen pounds of coal, which, at \$4 per ton, would equal a total cost of three cents. For colder weather and with two heaters this might be doubled.

Street railroad officers may compare this with the cost of coal used where there are stoves; and another most important point, the space saved, will, in one day, pay for the heating of the car for a week.

This heater requires no attention after it is charged.

Street cars can be equipped with this system at a very low figure, and it can be applied to horse, electric, compressed air, steam or cable cars.

There are no repairs needed after it is once fitted; the heaters will always outlast the car, and then be just as good to equip a new one, only requiring to be repainted.

Either one or both heaters may be charged according to the outside temperature, or the charge may be made less at frequent intervals, and the heat is radiated with the same uniformity, and at no time do the seats of the car become unpleasantly warm. The heater being placed near the floor it is quickly dried and does not remain sloppy or damp.

There is sufficient heat in the car to allow the ventilators to be opened from time to time, thus giving free circulation of fresh air.

### Economy of Electric Railways.\*

Even were electricity as expensive as horse power, its numerous advantages would ultimately result in its general adoption, but as a matter of fact, it shows very considerable saving over horse power. This is to be expected. If we have one source of power—one power station—instead of a thousand, we ought to generate the power at a less cost. If we have efficient motors and a well-constructed line, we should expect to utilize this power with little waste. Of 100 horse power produced in the steam engine, ninety-two is converted into electricity and goes out of the station over the line as electrical energy. The loss in the line need not exceed 10 per cent., though in some cases it may be economy to allow a larger loss. We thus have 82.8 horse power delivered to the motor on the car. If the commercial efficiency of the motors and gearing be 75 per cent. we have 62.1 per cent. horse power utilized in moving the car, or a total efficiency of 62.1 per cent. Of course, we may fall below this figure. The actual power required per car depends upon the grades, the speed, the curves, the kind and condition of track, the size and weight of the car, the average load, etc., conditions so variable that it is hopeless to try to determine any average figure. The power will range from 4 horse power to 9 horse power under ordinary conditions, and may increase very considerably under extraordinarily bad conditions. The cost of power at the station depends upon the kind and size of the engines, the price of coal, the management of the station, etc. It ranges as low as nine-tenths of one cent per car mile, and as high as seven cents per car mile. The latter is a very extreme case and does not represent the actual cost. This price is paid for power for a single car operated under the most disadvantageous conditions; this car, however, yields a better return to the railway company than any other car on its entire system. This indicates that a high price is not always incompatible with economical results. The

\* Extract from lecture delivered by Captain Eugene Griffin at Franklin Institute, Philadelphia.

\* Gold Car Heating Co., New York; Western Office 422-423 Phenix Bldg., Chicago.



cost of repairs depends very largely upon the care bestowed upon the apparatus, and any figures given without a full statement of all the special conditions would be misleading. I have known the cost of material for repairs on a large road to run as low as nine mills per car mile for one month, and I have known it go very much higher.

Speed is not only an important factor in determining the value of electric railways to the public, but it is equally important to the railway manager as a source of economy. If we average six miles per hour with horses and nine miles per hour with electricity, it is evident that in the latter case one car does 50 per cent. more work with a corresponding saving in the item of wages of conductors and drivers.

In the crowded city streets we cannot hope to gain much speed. In the suburbs the gain is only limited by considerations of safety. From Harvard Square, in Cambridge, to the end of the line, in Arlington, the electric cars average about eleven miles per hour, including stops—better time than is made by the elevated roads in New York City. On the Watervliet Road between Albany and Troy, the following is the record of one month's work :

MILEAGE OF WATERVLIET CARS, DECEMBER, 1889.

Average number of cars in daily service	7 1/4
Total mileage, thirty one days	31,340
Average daily mileage	1,011
Average daily mileage, per car	139

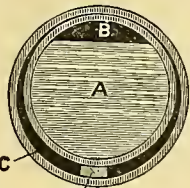

STREET CAR HEATING (Gold System).

in speed will be greater when all the cars are equipped, as the average is now kept down by the horse cars holding back the electric cars running on the same tracks.

The increased speed should not be lost sight of in comparing the cost of operating electric, with the cost of operating horse cars. A comparison on the basis of car days is not a just one. The comparison should be made on the basis of car miles. On the Watervliet road the daily mileage per car has been nearly doubled by the use of electricity.

Another economical feature of the use of electricity is the ability to haul one or even two tow cars. We can double or even treble our carrying capacity in case of emergency; and the extra plant kept for such purposes is in the cheapest form, representing a comparatively small invested capital, and subject to but little deterioration. Compare this with the cost of keeping extra horses sufficient to double or treble our carrying capacity. The difference is enormous.

On those roads or lines where the traffic is great and constant, we will have larger cars. By using the radial truck or double trucks, we can handle 30-foot cars as easily as our present standard form, and do away with the annoying and destructive teetering inseparable from a long car mounted on a 6-foot truck. We can nearly double the seating capacity, and still use but one conductor and one driver.

From the foregoing it is evident that electricity admits of many economical changes and that, in many ways, we may hope to reduce expenses by its use, at the same time giving better service. What we must look to, of course, is the ultimate commercial result. Whatever may be said pro and con, the commercial result must be the final criterion.

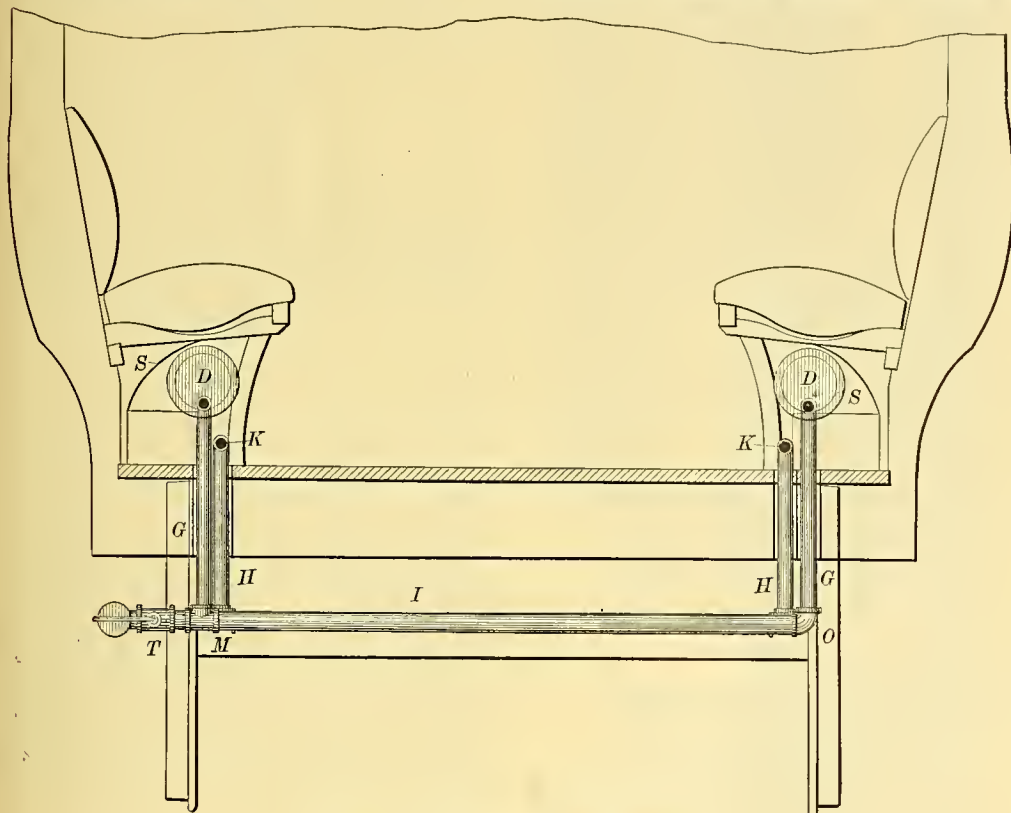

STREET CAR HEATING (Gold System).

On December 20, 1889, we have the following record of five cars :

Car No. 43 made a total of	180
" 44 "	190
" 45 "	190
" 46 "	190
" 61 "	180
Grand total	930
Average per car	186

On January 3, 1890, we have the following record of five cars :

Car No. 40 made a total of	190
" 42 "	190
" 44 "	190
" 60 "	180
" 62 "	180
Gand total	930
Average per car	186

This is an imposition upon the motors. It is requiring more than we ask of the steam locomotive which runs under the most favorable conditions as to grades, curves and track. I give these figures as an instance of what can be done and what is done, not as an example of what should be done. We must be reasonable and not work the willing horse to death.

Increased speed is a great boon to the public, always clamoring for rapid transit. By the aid of electricity we have increased the average speed of the cars in Boston from six miles per hour to eight miles per hour, and were all the cars equipped electrically, this increase alone would make an annual saving to the passengers of 4,152,000 hours or about 474 years. Think of this as one year's saving in one city resulting from the use of electricity as a motive power for street cars. As a matter of fact, the gain

in speed will be greater when all the cars are equipped, as the average is now kept down by the horse cars holding back the electric cars running on the same tracks. We are now receiving some light in this direction from the annual reports of the roads in those states where the statutes require such reports. Such statistics are of great value, for whatever difference may exist as to classification and arrangement, the total expenses and the total receipts are bound to appear in some form or other. From the reports of the Railroad Commissioners of New York and Massachusetts for the year 1889, we extract the following :

EXPENSES OF STREET RAILWAYS, NEW YORK STATE, 1889.

Horse Roads.—Average proportion of receipts to

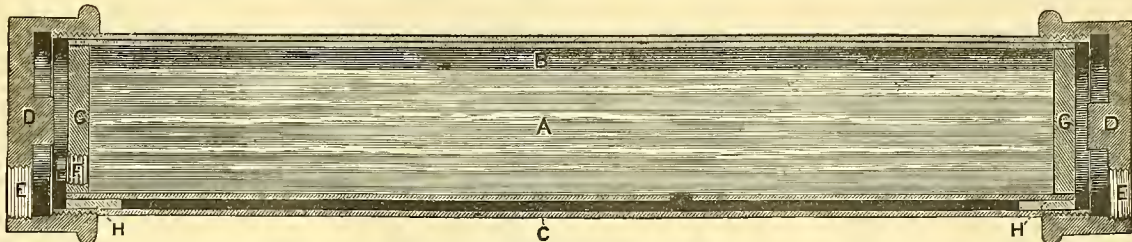

STREET CAR HEATING (Gold System).

operating expenses, thirty-three roads, 79.39 per cent. Electric Roads.—Average proportion of receipts to operating expenses, two roads, 53.50 per cent.

EXPENSES OF STREET RAILWAYS, MASSACHUSETTS, 1889.

Horse Roads.—Average proportion of receipts to operating expenses, thirty roads, 82.87 per cent.

Electric Roads.—Average proportion of receipts to operating expenses, two roads, 55.50 per cent.

In 1888, the gross earnings and operating expenses of surface and elevated roads in three states were as follows :

RECEIPTS AND EXPENSES PER PASSENGER, 1888.

	Gross Earnings	Operating Expenses	Net Earnings
	Cents	Cents	Cents
Elevated Roads—New York State	5.01	2.81	2.20
Surface Roads—New York State	4.94	4.02	.92
Third Ward Electric Railway—Syracuse (1889)	4.92	2.78	2.14
Surface Roads—Pennsylvania	5.59	3.18	2.41
Surface Roads—Massachusetts	5.10	4.28	.82
Boston and Revere Electric Railway (1889)	4.70	2.71	1.99

The column of operating expenses contains some very significant figures.

Such figures are more convincing than any labored argument. In time, as we have more of these reports, the skeptical will become convinced, and the doubting will be satisfied.

FIRST COST.

If electricity does all that is claimed for it, then it is a necessity in street railway work. If the railway president investigates and finds that the claims are well supported, that electricity is safe, economical, durable and reliable, then he seeks to know the cost. A really good article is expensive. Electric motors are good articles.

The cost of equipment for a first-class double track road, including iron poles (side suspension), fifty-six pound girder rail, one 16-foot closed car and one open tow car to each mile of track, suitable generator and steam plant capacity, etc., would be approximately as follows :

PER MILE OF TRACK.

One mile of track (paved street)	\$10,000
One motor and one open tow car, generator and station equipments, line construction, including poles and steam plant	10,000
	\$20,000

A double track road ten miles long would cost on this basis \$400,000, including twenty motor cars and twenty tow cars.

On a road with very bad grades, greater power might be required. If wooden poles be used, the cost of the line would be very materially reduced.

And now a few words as to the future of electric railways. The success of electrical propulsion has been established beyond question. It is only a matter of time, and that a short time, when it will replace the horses on the majority of our street railways. It is only a matter of time, a somewhat longer time perhaps, when it will be the propelling power on all our elevated roads, for the elevated roads possess ideal conditions for the application of electricity. It is within the bounds of possibility that our steam roads will be run with electricity; certainly this power offers many advantages for the suburban traffic in the vicinity of the large cities. The possible utilization of hitherto neglected water powers will be one of the factors in determining the extension of electrical propulsion in this direction. Already we see the beginning. The West End company of Boston, are building longer cars with radial and double-sweveled trucks. The New York elevated roads are anxiously seeking a solution to the problem of how to enlarge their carrying capacity without rebuilding or materially altering their superstructures. Longer trains are requisite to meet the increased demands. The limit of the capacity of the present locomotives has been reached. Increased weight in the locomotive means an immense expenditure for strengthening or practically rebuilding the roadway. Cables are not feasible, as the strain on the grip would not permit of long trains, and it would be difficult to combine speed and safety with any considerable increase in the number of trains. Cables would not permit of satisfactory switching arrangement at the termini and elsewhere. Electricity offers the best solution. Equip each car with motors. Flexible electrical connections can easily be made from car to car as is now done on surface roads to light the tow cars, and the whole train controlled by the driver on the front platform of the leading car. Electric,

vacuum or air brakes can be used in the same way. It matters not how many cars we have in a train—one or fifty. Each car adds its own power, and all work together. There is no dead weight to pull, as in the case of the locomotive. The passengers themselves furnish the weight for traction. The switching arrangements present no difficulties whatever. The motors can be reversed and run equally well in either direction. The train can be controlled from either end and any increase or decrease in the number of cars will not affect the controlling mechanism. It is difficult to conceive of a more flexible system. It seems to be the ideal system for the elevated roads, and is bound to be adopted in the near future.



**New Designs in Poles.\***

We show in this issue a number of new designs in iron and wooden poles recently placed upon the market by the Sprague company.

Poles Nos. 5, 6, 7, 9 and 10, as shown in the accompanying views, are for use where double

**Does Current Between Wheel and Rail Increase Traction?\***

BY O. T. CROSBY.

We have not infrequently seen in print and heard in conversation the statement that in electric railways, working on a grounded circuit, there is an increase in the adhesion coefficient over that obtained in steam propulsion, due to the passage of the current through the wheels. To obtain some light on this subject the following experiments were made:

The car used was fitted with two motors of the second type made by the Sprague company. Its total weight was 10,900 lbs. The rail was of the tram type, and, though rusty, was reasonably free from dirt. The wheels showed tires in ordinary service condition. In such case the

The control thus obtained was somewhat irregular, but answered the purpose. The current could be taken up quite regularly from 0 to about 20 amperes; from that value it frequently jumped to about 42 amperes. In such case the wheels always started to skid, whether ground was made through the wheels or directly to rail. When the current could be made to approach 42 amperes through a

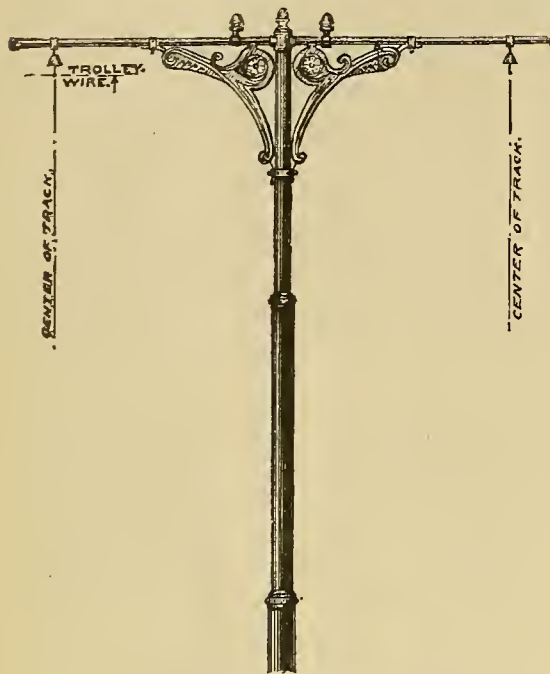

No. 7.

tracks are used, and a center double bracket pole is required.

Poles Nos. 5 and 6 are somewhat simple in design. The main current wires in these poles are carried directly on the pole itself, instead of on the bracket arms. These poles are also set in concrete, with their base resting upon a stone foundation.

Pole No. 7 is a very popular style of double track iron pole, of neat and tasteful design. The method of setting is the same as in the other styles.

Pole No. 9 shows a wooden pole with square section at base and top, and octagonal during the greater part of its length. The pole is tapering, being ten inches square at the base and seven inches square at the top, before being pointed. The bracket arms are of iron to secure it firmly in place. The method of setting the pole is clearly illustrated in the view, the pole being set in stone, and tamped firmly in place.

Pole No. 10 is used for span wire construction, one pole being required at each side of the street, the trolley wire being suspended from the span wire over the center of the track. These



No. 10.

ordinary coefficients would show a possible tractive effort, before skidding, of 2,500 to 3,500 pounds. As this would have required currents greater than I cared to use, and would, moreover, have exceeded the capacity of the dynamometer at hand, it was determined to skid only one pair of wheels, and to relieve these of a part of their weight. One end of the car was, therefore, jacked up until the springs were almost, or wholly, relieved. This made it impossible to get dynamometer and current readings simultaneously, as had been desired. However, the ammeter and dynamometer were separately compared.

The currents necessary to produce skidding were first observed when the ordinary connection to ground, *i. e.*, through the metal of the motors, truck, wheels and rail, was in position. The connection was then changed, the ground wire being taken directly to the rail, at a point near the grounded terminal of the dynamo. The wheels were thus out of circuit.

As the first position to which the controlling switch can be thrown admits a current of about 50 amperes (one motor in circuit), a graduated resistance was improvised by putting a soldering iron and a tin plate in circuit; these were approached to, or separated from, each other through a tub of water, in the bottom of which lay the tin plate.

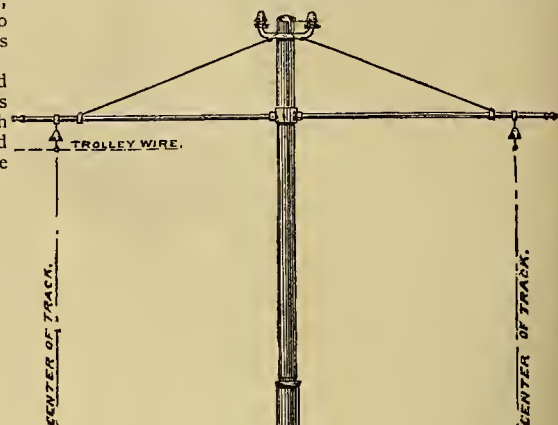

No. 6.

better gradation, as with intermediate values of 30, 34, 36 amperes, the skidding did not occur until a higher reading was reached—up to 50 amperes. When the jump was considerable, skidding occurred at even lower values than 42 amperes, as is shown in the accompanying table:

*Wheels in circuit.*

(1) Current.—	0	12	16	37	..	Here wheels skidded.
(2) " "	0	12	14	37	--	" "
(3) " "	0	14	16	40	--	" "
(4) " "	0	12	16	42	--	" "
(5) " "	0	10	12	42	--	" "
(6) " "	0	25	16	40	--	" "

Similar records, up to 12 in number, were obtained.

*Wheels out of circuit.*

(1) Current.—	0	12	31	16	42	..	Here wheels skidded.
(2) " "	0	14	16	18	42	--	" "
(3) " "	0	15	34	40	39	--	" did not skid.
(4) " "	0	15	42	40	35	--	" "

In the last case (4) the rise from 15 amperes to 42 was not as sudden as indicated in the table, though too quick for the recorder to get clear differences. A number of similar trials was made, to the number of fifteen or twenty. In one case of gradual approach up to 40 amperes, without movement of wheels, the controlling switch was thrown into a position giving less resistance in the field; the current rose to 52 amperes, and the skidding began quite vigorously. The change in position of the switch, the current values being such as are here considered, has little effect on the strength of field produced by the three field-coils, the arrangement of which is changed by the switch-

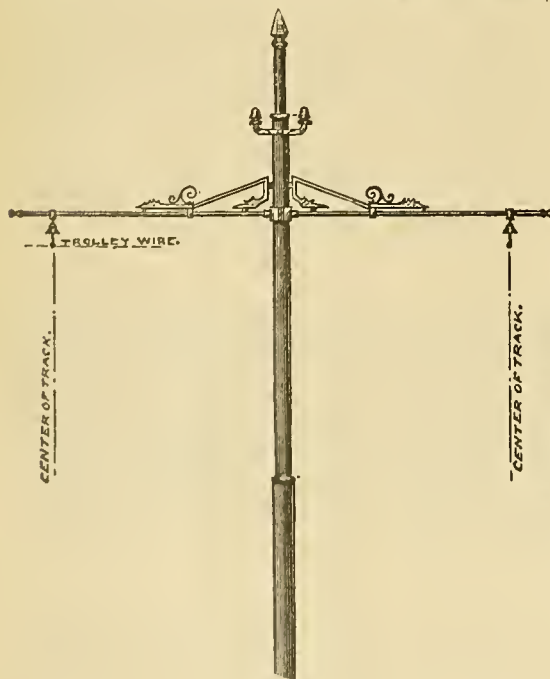

No. 5.

poles are equipped with pole ratchets, shown in the view, for tightening the span wire. The main current wires are carried on the cross-bracket near the top of the pole.

\* Sprague Electric Railway and Motor Co., New York.

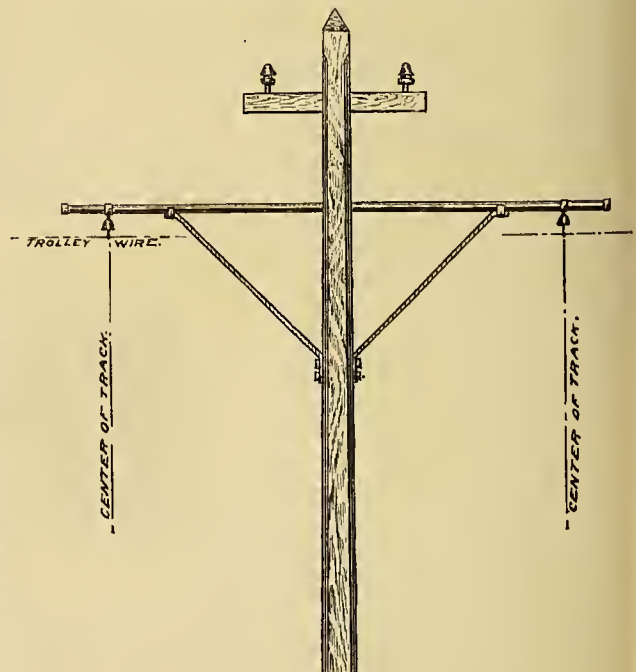

No. 9.

movement; saturation having been reached for any arrangement produced by the switch, at lower currents than the effective values, as shown above.

While the sudden current changes might conceal the particular value just sufficient to produce skidding, the existence of the values, 34 and 25 in the tables above,

\* Electrical Engineer.



shows that 37 amperes is about the lowest value, if approached with some gradation, that could produce skidding. This is further shown by this record:

*Wheels out of circuit.*

Current.—	0	10	15	23	24	25	—	No skidding.
"	0	12	15	22	20	23	—	"

A general conclusion may be stated—that, while the test was not delicate enough to prove that *absolutely no difference* of adhesion exists in the two cases, yet the difference, if it exists, is not worth considering.

Aside from this test, I may say that with nearly the whole of the experience of the Sprague company to refer to, I can recall nothing which refutes the conclusion here drawn. Furthermore, it is to be remembered that up to date the double metallic systems have climbed as steep grades as the grounded systems. In making these experiments it was noted that the slack of the gearing was taken up at from 5 to 10 amperes. When freed from the supporting chocks, the car started at from 10 to 20 amperes, the needle moving so quickly as to prevent accurate reading. When started by man-power, exerted through a dynamometer, the record shows 175 to 210 lbs. pull, varying with slight irregularities in the track (called level, but varying slightly in grade and condition of surface).

Correspondingly, when the car was held fast by a chain the dynamometer in the line of pull, a steady current of 14 amperes through the motor produced a reading of 175 lbs. on the dynamometer, showing the true starting current to have been about 15 amperes. As this occurred when the current passed through the wheels, it again shows that there is no appreciable resistance to wheel movement, either as to skidding or rolling on the rail, produced by the passage of the current.

It is to be remembered that the momentary starting current, as shown by an ammeter, is a function, not only of the actual torsional effect required in the motor, but of the total resistance which it has pleased the manufacturers to insert in the motor circuit. Unless controlled, as was here the case, this initial current may, therefore, be greater than *just enough* to start the car.

The writer is indebted to Mr. Offut, superintendent of the Brooklyn and Jamaica Electric Railway, for the use of a car in making these trials.

**The Patton Motor.**

The accompanying sketch shows the Patton Motor coupled to a double-truck Pullman palace street car, as it appeared at a public test at Pullman, Ill., April 22, in the presence of a large number of prominent men, and a representative of THE STREET RAILWAY GAZETTE.

This electric motor car is the first one constructed by the Patton Motor Manufacturing Co., of Chicago, upon a system peculiarly its own, and merits careful mention as to details.

The basis of operation is the generation of electricity upon the vehicle, thus rendering each car independent, and dispensing with over-head or conduit wires for the transmission of electric force. By this system also all the obstacles which have rendered the service of so-called storage battery cars so unsatisfactory, have been removed.

The plan is simple and inexpensive. The gas engine runs continuously, and is geared to a dynamo generating electricity, which is received by accumulators where it is stored for service as desired. An electric motor is geared to the axles, and the current necessary for the propulsion is admitted to the said motor in a greater or less degree, according to the power required at any given moment. Thus the movement of the car is entirely subject to the will of the operator, who can regulate the propelling force in accordance with the obstacles to be overcome.

Meantime the storage batteries are kept continually charged by the engine and dynamo, so that reserve force is always in readiness for any emergency. The entire cost of maintenance of this power is 1 1/10 cents per mile.

The engine, dynamo and motor are carried upon a truck specially devised for the purpose, by which plan the car body can be removed very readily, and the same truck suffice for an open car in summer or closed car in winter. The batteries are arranged under the seats of the car. The motor car, as shown in the accompanying cut, weighs with the truck and all mechanism complete, 14,100 pounds, and has seating capacity for thirty passengers. A single fifteen h. p. motor was used, as it was intended that the car should run without trailers, simply to show the success of the plan, but at the trial of April 22d, above referred to, it was desired by Mr. Geo. M. Pullman, and others, that the power be tested to a greater degree, and the Pullman palace street car, the only one of its kind ever constructed, was coupled to the Patton Motor for this purpose.

It must be borne in mind that the Pullman railway was constructed with a view of giving

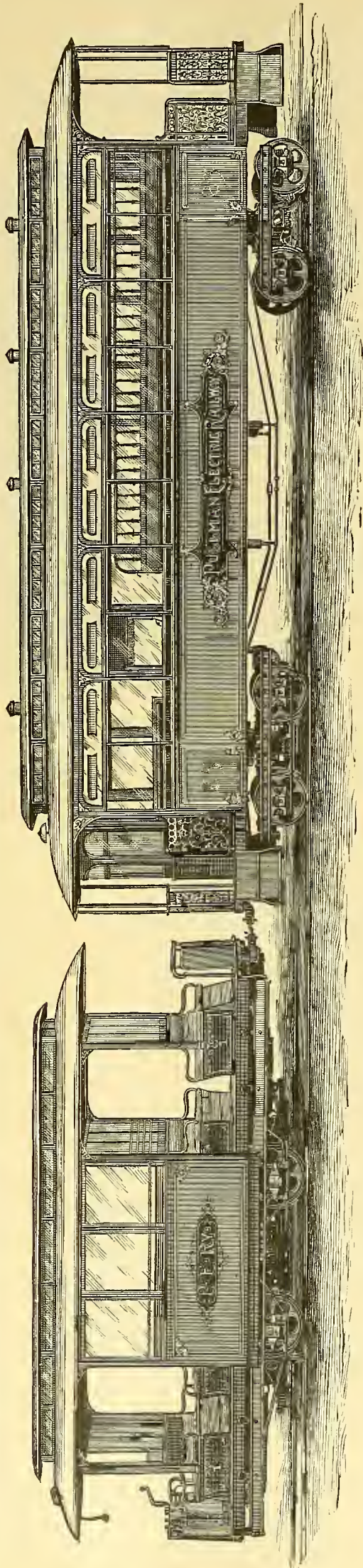

THE PATTON MOTOR.

severest possible tests to any motor cars which are manufactured at the Pullman Car Works.

It is 3 3/4 miles in length and has 25 curves, many of them 22' 6" radius.

The Pullman car weighs 15,800 pounds, thus the entire weight of the empty train was 29,900 pounds.

The first trip was made with the motor alone, carrying 37 passengers, making the circuit at the rate of 10 miles an hour. The second trip was made with the above mentioned car attached, with no diminution of speed. All present were well pleased with the result.

The trial of the Patton Motor was a great success. Among those present were Geo. M. Pullman, Henry Villard, Marshall Field, N. B. Ream, A. B. Pullman, C. L. Pullman, T. H. Wickes, G. F. Brown, H. G. Bird, H. H. Sessions, W. H. Patton and the GAZETTE's representative.

The motor is in constant service on the Pullman Electric railway, and can be seen at any time by parties who so desire.

Mr. A. B. Pullman, president of the Patton Motor Mfg. Co., has devised several plans for cars peculiarly adapted to carrying the required details, with or without capacity for passengers—thus these cars will be constructed to serve solely as motors or (as in the present instance) to carry passengers. One of the plans shows a "double deck" car, the upper compartment closed, warmed with hot air, and lighted with electricity; the sides and roof so constructed as to be easily removable, and replaced with a light canopy for summer service.

**From Buenos Ayres.**

**TRAMWAYS IN THE PLATA.**

The following appeared in a recent issue of the Buenos Ayres *Standard*. It tends to show how the dividend-loving directors in England look after their property here:

History threatens to repeat itself. Just as the mismanagement of railways, the utter disregard for the comforts and necessities of the traveling public and the scandalous delays in the forwarding of the country's produce, brought on a long expected and much deserved retribution, in the shape of a railway inspection bureau to correct abuses; just so the tramway companies are bringing on their heads the creation of a National Tramways' Inspection Bureau, to put an end to the sufferings of this patient and too-resigned public.

It would appear that the narcotic influence of yearly big dividends has lulled to sleep the senses of tramway companies. In their Rip Van Winkle lethargy, hibernating on yearly 10 per cent returns, the chairman, directors, managers, and shareholders are forgetful of the march of the world around them and of the requirements of that dull public which pays for those dividends and guinea-pig emoluments. Year in, year out, we have preached in the desert; we have suggested more humanity to the horses, more rolling-stock for the public, and less disregard of the requirements of those who are the bone and sinew of the yearly returns, but in vain.

It is high time that the National Government appeal to Congress with a bill to put tramway matters aright by the creation of a board under the control and superintendence of the National Railway Inspection Bureau, to see that the line is drawn between the rights and duties of tramway companies. This is not only feasible, not only imperious, but it is a satisfaction that man and horse demand from their tramway masters.

The people of Buenos Ayres are tired journeying in open tramways at night in winter, tired of standing every evening on knife-boards to get to their homes, tired of overcrowding cars and over-burdening the game little horses who are fed to a certain point to stand "four years' work." The people are tired of cars with creaking doors, smashed windows, and wickless lamps; tired also of break-downs, from overcrowding and brutalizing sights, such as horses dropping to the ground from sheer exhaustion, slipping under the cars etc. The public cries *basta!* and appeal to the government for redress.

Let the tramway companies be brought to their senses and taught that they must supply cars for the traffic. Let all apologies for the lack of that rolling-stock be disclaimed; months ago these companies should have ordered hundreds of new wagons to relieve the congestion of traffic; months ago they should have given orders for the purchase of fresh horses. Meantime, what have they done? Well, they may have done everything from buying buttons for the guards' coats to getting out a new patent for punching tickets, but they have done absolutely nothing, or next to nothing, to meet the requirements of traffic.

It is sheer nonsense to state that such or such a company have ordered new cars, purchased new horses, but that the traffic grows too quickly for them. It is the bonnden duty of these companies to the public to meet that growth of traffic, to anticipate it, and be fully equipped in all circumstances. Let there be an end to the daily sights of overcrowding, and since common sense, a consciousness of their own interests, does not prevail on the companies to reform, well, then, let the Government step in and protect the interests of the public. More of this anon.

The above is only a slight and one of many accounts that appear in the newspapers, and



shows what a disgraceful way the traveling public are treated by these London tramway companies, but here there is no law by which a person might "run in" the manager of the line, for cruelty to the horses and the scandalous treatment of the passengers.

The writer has seen horses of the tramway companies dying in the streets wholly from over work, starvation and cruelty, by which three-named courses these poor little animals always meet their death, at the hands of the brutal drivers and indifferent companies, for whom they toil so hard.

Cruelty, delays, and other inconveniences will all end when motive power makes its debut, which is now being talked over in this city and when started (which is thought will be soon) will be a relief to humanity and the end of the now ceaseless barbarous treatment to the poor tramway horse, who is a victim at the hands of the savage driver, until death relieves him.

A public carriage company has been formed in Buenos Ayres under the name of "La Bon-aerense," with a capital of \$2,000,000, divided into 20,000 shares of \$100 each.

The statutes have been approved and contain some novel features. The share capital can not be increased, but if further capital should be required for extending the business, bonds will be issued at a fixed rate of interest.

The operations of the company will be conducted in a manner similar to those of the General Carriage Company in Paris, which has been highly successful. One-horse carriages will be used, the weight of the carriage being adapted to the average size of the horses of this country (which are only the size of ponies); the horses are to be well fed and cared for, and land will be bought for pasture and training ground. Workshops will also be erected where the carriages will be built and repaired. The rates are to be as low as possible. It is intended to employ at least 500 carriages in the business.

The above is a thing much needed here, and when started, will be a great boon to the public at large, and saving of time and money to commercial men who desire quickness and moderate prices.

FRANCO LODIA.

### Makin' of the Motor.

Have you heard of that famous Pittsburg man,  
Who said to himself, "I certainly can  
Make a wonderful motor on a wonderful plan.  
A motor that when it has once began,  
When called upon, to do its work,  
Will never fail and never shirk.  
That will have a car 'from A to Izzard,'  
Fast as lightning or slow as lizard.  
A motor 'twill do the very thing  
That man has wanted, or man has done,  
Or man has thought of, under the sun.  
A motor that must surely turn out  
One of those kind that will not burn out.

But before I start on this creation  
I will summon men from every nation,  
Men who are skilled in every station,  
Men who are skilled in iron and steel,  
Familiar with copper and wire reel,  
With boiler and engine, gear and wheel.  
Wherever I find a man of knowledge,  
From shop or farm or store or college,  
He is the man that I will take in  
To add his mite in this famous makin'  
Of this famous motor that's bound to stand  
The highest product of brain and hand  
That was ever realized in the land."

So he gathered together in Pittsburg town  
Men of science and wide renown,  
Men for work and men for brains,  
Men all covered o'er with stains,  
From crucible, mine, from shop and bench,  
So that all might together from Nature wrench  
The art of making a current tote a  
Heavy load through an electric motor.

For years and years these men worked on  
And then before their eyes saw done  
Machines and engines without number;  
Besides a lot of smaller lumber,  
Which from a reckoning must not be lost  
When calculating total cost.  
But still they worked as for a prize,  
And still they saw before their eyes  
A motor perfect in every part,  
The highest triumph of electric art.

And they swore together that they would build  
Just such motors as surely filled  
The wants and wishes of all mankind,  
Even if they had to go it blind.  
They swore it should be the very best,  
With every part as strong as the rest,

Strong as the rest and yet no stronger,  
So that no part would last the longer.  
That there should be no weakest spot,  
No armature burnt or bearing hot  
To stop the working of the lot.

They tried first one thing, then another,  
Sparing neither time nor bother.  
Every region they ransacked  
For anything they thought they lacked;  
On every side the things were stacked.

From Norway came the iron and steel,  
From Michigan the copper reel.  
They sent to China for their silk,  
The Brazilians gave the rubber milk,  
Which, in another form, another nation  
Makes into excellent insulation.  
From Texas came a dozen sides  
Of tough old leather, once bull hides,  
But now, when cut and duly laced,  
And covered o'er with patent paste,  
A thousand horse power will carry away  
On a two-foot pulley without slip or play.  
From Wales came sheets of lustrous mica,  
Glittering in the sunlight like a  
Waterfall with foamy breast,  
A rainbow shining on its crest.  
Mahogany and rosewood trimmed by labor  
Of Mexico, our nearest neighbor.  
Paint, paste, paper, cement, japan,  
Of beauty enough for a lady's fan,  
Was about the right thing for this Pittsburg man,  
Who thus gathered together from round about  
Skill and science, the latest out;  
From every clime its different goods,  
Metals, minerals, native woods.

The solid shaft by hammer was steeled,  
Made from a certain famous weld  
Of hardness, such it would not yield  
To touch of file, and yet so tough  
'T would stand for a hundred years and enough  
Be left for shaft of a size  
As would take the place where first it lies.  
Gears and brackets, screws and wheel,  
Exactly cut from the selfsame steel,  
Cut so exactly they would not feel  
A hundred years of wear and tear.  
But still, as first, would do their share  
Of the common burden all must bear.

The poles and cores of iron were wrought  
Of the purest metal that could be bought,  
With its co efficient of magnetism  
Acknowledged the highest, without a schism,  
By every professor of every ism.  
While huge steel bolts throughout their length  
Bound them to their keeper in greatest strength.  
The armature core of discs of iron  
Separated from each other by an-  
Other insulating mica sheet,  
The whole made up in a way so neat,  
It had the look of a solid thing,  
Not a succession of ring on ring.

And now came the most important part,  
What might, perhaps, be called the heart,  
Of winding around this solid core  
The coils of wire, o'er and o'er.  
Hard drawn wire of purest copper  
And round the wire was silk to stop a  
Bit of current from crossing over,  
To stay a wild, rebellious rover,  
Instead of going as they had taught a  
Current to go and where it o'er.  
A solid block was the commutator,  
Sawed to segments, and then, later,  
Between the segments, an insulation,  
To separate each from its relation.  
To each of these pieces a wire was bound,  
And, following this wire, it is easily found  
That each armature coil, by a couple of bends,  
Has opposite segments for two solid ends.

The shaft, like a coat, its armature wearing,  
Was fitted to turn in a self-oiling bearing.  
And, as this is the place where is only found friction  
In the whole apparatus, it is not a fiction  
To say that the shaft spun so easily round  
There was more power lost 'twixt a top and the ground.  
It is true the commutator the brushes wear on,  
But still, the pressure with which they bear on  
Is as light as a fly from the evening breeze  
Which lights on your nose and makes you sneeze.  
The brushes are made of graphite fine,  
The purest product of the mine;  
Each bolt and screw, each rivet and pin  
Will hold as fast as original sin.  
For they, with each pinion and spring and wheel,  
Are made of the very finest steel.  
Of copper pure each switch connector,  
All nicked so deep you could not resurrect a  
Smallest place, long years from hence,  
Similar to paint scratched off of a fence.  
Yes, they made it a beauty, as well as of use.  
In nickel and silver they let themselves loose,  
And they did it so fine, so well were they able,  
One was stolen, to ornament a swell parlor table.

A machine complete in every detail,  
And yet a machine that is sold at retail,  
At prices that show that every "Trust"  
Must come to line or go to rust.  
With worked out details of construction,  
That, in themselves, will cause reduction  
Of space and cost of bother and care,  
Of labor and worry and wear and tear,

So after years of labor and pain,  
The Pittsburg man has, once again,  
With his busy brain and sturdy heart,  
Become the leader in his art.  
At last the motor stands before him,  
He swings the switch that hangs just o'er him,  
When with a buzz and whiz and rush  
The motor starts; but wait, a hush!  
Has the motor stopped? No, far from that,  
It whirled around at a speed that sat  
On the polished bearings, with easy grace,  
It seemed as if it was still in its place,  
Instead of going at such a pace  
That ne'er machine of any make  
Has, heretofore, e'er dared to take.  
It still is going and still it will  
Up to that very moment till  
Like the Deacon's wonderful one hoss shay  
Every part will pass away.  
"All at once and nothing first  
Just as bubbles do when they burst."

And now they make these motors fast,  
Make them strong so they will last  
As long as the first and even more.  
They fasten them below the floor  
Of rapid transit cars, for cities,  
And people cry: "A thousand pities  
We did not know of this before."  
And still demand for them increases  
Until like England's royal flag,  
Which in the sun does ever wag,  
The world itself will go to pieces,  
And every person on it ceases  
To care for travel except on wings.  
But up to that time he gaily sings  
Whenever I travel near or far  
I go on a Westinghouse motor car.

### MORAL.

Every city must have rapid transit.  
Many a town that thinks it can sit  
Even to doomsday in the same old place  
Regardless of what may be the pace,  
You will find next census out of the race.

C. EMERY.

### Rae Generator.\*

In the accompanying cuts is shown a Rae 65,000 watt generator compounded for 500 volts at a speed of 850 revolutions per minute, but it is so constructed that it will yield for a considerable length of time 23 per cent. beyond the nominal output. The field cores are cylindrical, and made of the softest wrought iron. The pole pieces and base are of the best cast iron. The shunt coils are of double covered wire wound on brass sleeves which are heavily insulated. These coils are constructed so that they may be easily slipped off the field cores. Immediately above and below the shunt coils are cut grooves on the pole pieces. These contain the series coils of insulated copper ribbon.

The armature is of very low resistance, and is wound with two layers of wire. It is of the drum type and the core is constructed of insulated disks of imported iron, in the following manner: The body is divided into sections, each of which is insulated from its neighbor by shellaced cheese cloth, and built up of alternate disks of iron and paper. These iron disks are .006 or .007 of an inch in thickness. The whole is drawn together and clamped by means of washers and nuts, special precaution being taken to insulate the shaft and to secure the necessary driving pins which engage the wire.

The bearings of this dynamo are of the latest pattern, and oil throwing has been avoided by careful design. The connecting wires are colored black and are highly polished, and give the appearance of good workmanship and finish.

### Chancellor Gibson's Knoxville Decision in Favor of Electric Railways.

*The East Tennessee Telephone Company vs. The Knoxville Street R. R. Company.*

This is a suit brought by the telephone company to enjoin the railroad company from using the earth as a return electric circuit, and from interfering with the electrical condition of the air, to its injury.

The telephone company claims:

- (1) That it has a grant from the city to erect poles and string wires in, over and along all the public streets and alleys of Knoxville;
- (2) That it has such posts and wires, and is doing a telephone business;
- (3) That the railroad company is about to use electricity as a motor, with the earth for a return circuit;
- (4) That the telephone company is now using the earth for its return circuit;
- (5) That both companies can not so use the earth at the same time, as the telephone current is too delicate to contend with the railroad current;
- (6) That the railroad company's wires are also liable so to affect the electricity in the telephone wires, or are liable

\* Detroit Electrical Works, Detroit, Mich. Courtesy of Western Electrician.



so to charge the air with its electricity, as to interfere with the very delicate electrical currents used by the telephone company;

(7) And that the telephone company has a "vested right" to the "exclusive use" of the earth and the air as against every person using the same for electrical purposes to the detriment of its telephones.

For these reasons the telephone company has obtained a temporary injunction against the railroad company inhibiting the latter from using the single trolley system or any other system that uses the earth for a return circuit.

wires" on said poles, or about "using and operating the same for the purposes of telephonic and telegraphic communication."

I mention these matters for the purpose of ascertaining what rights were granted by said ordinance—to measure their comprehensiveness. The bill claims practically unlimited rights to erect poles, string wires, and "use and operate the same" "in, over and along" all the "public streets, alleys, lands, roads and public squares" in the city; whereas, the ordinance merely gives the "Exchange," not the company, the "privilege of erecting poles on the

only gave the Telephone Exchange a right to use all the ground, public and private, within the corporate limits, as its own, but the right to use it to the exclusion of all other electric companies from now to the ending of the world, he would have been regarded as a wicked exaggerator, if not a deliberate falsifier. And yet this is exactly what the telephone company claims in its bill.

I am unable so to construe this scant "privilege of erecting poles" as to make it "grant the right" to the exclusive use of every inch of ground within the corporate limits, for all the purposes of an earth circuit for electricity. Such a grant could never have been in the minds of the mayor and aldermen; and I am unable to find these exclusive rights and monopolistic powers condensed in five such harmless words as "the privilege of erecting poles."

The telephone company, however, does not content itself with literally claiming the exclusive use of the whole of the earth on which Knoxville is built, for its return electrical currents, but it claims a monopoly of the whole air also, and insists that no other electrical company can string its wires in the near neighborhood of the telephone wires. And thus the simple privilege of "erecting poles" on the side of the streets of Knoxville is magnified into a grant of the exclusive right to all the earth and all the air within the corporate limits of Knoxville, for all electrical purposes, except telegraphing.

But it may be urged that the ordinance says that "this privilege of erecting poles shall be confined to telephone exchange purposes exclusively." So it does; but will it be contended that these words, which are rather words of limitation than of extension, give the telephone company the exclusive right to use every inch of Knoxville's ground and a superior right to all its air, as its private property for electrical purposes?

And thus it is, this once humble telephone company, that was given the bare privilege of "erecting poles" on the edge of the curbing, now comes forward, and, by virtue of those two talismanic words, claims the right to make the electric light companies, the electric railroad companies, and all other electric companies, for all time to come, keep their wires from communicating with any part of the ground on which the city stands or else pay it for the privilege of so doing. In a word, it claims a perpetual monopoly of the earth upon which the city is built for all the uses of an electrical circuit; and also claims a superior right to the air itself, for electrical purposes.

Ordinarily a person's strength consists of his physical power, but the telephone company's strength is sought to be derived from its weakness: it says that its electrical current is so weak that all strong currents greatly affect and impair its usefulness, and that, as a consequence, no company using a strong current can lawfully use the earth for a return circuit without its leave. If this contention be correct, then no electric company can ever use the underground on which Knoxville is built without the consent of the telephone company. It makes no difference what grand discoveries and inventions in the use of electricity may be made. Coal, wood, gas, steam and animal power may all be superseded by electrical devices, machines may be invented to heat and light all of our homes, do all of

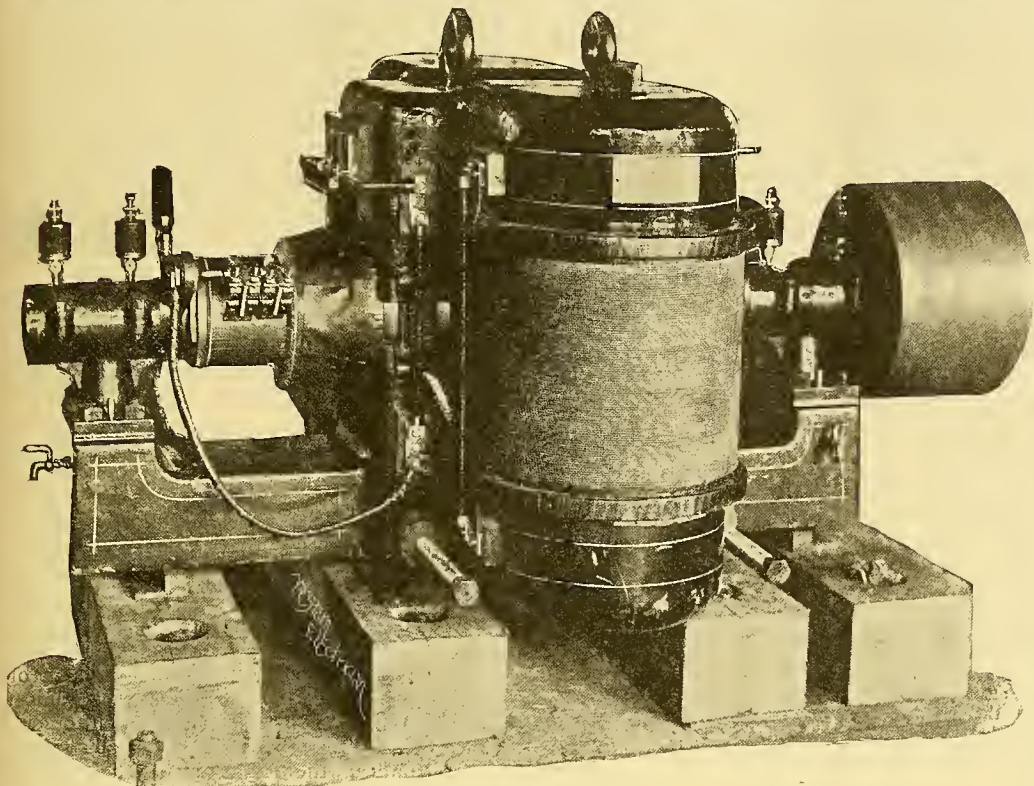

FIG. 1.—RAE GENERATOR.

To this bill the railroad company has put in a sworn answer, setting up, among other defences, the following:

(1) The ordinance under which the telephone company claims its rights does not vest in it any such rights as it claims.

(2) That what rights the ordinance does give are not the property of the telephone company.

(3) That the railroad company's electrical appliances will not injure the telephones;

(4) And that if they should, the injury can cheaply be remedied.

On this answer, the defendant moves the court to dissolve the injunction.

On the hearing of this motion, the affidavits of many electrical experts have been read, much electrical literature has been offered, not a few judicial opinions have been cited, and most able and elaborate arguments have been made. The whole subject of electricity has been brought before the court, including a miniature telephone plant and a miniature electric car and electric railroad, so that Menlo Park itself seemed, in miniature, before the court. The main questions for determination presented by the pleadings are: 1st, were such rights as the telephone company claims conferred upon it by the city of Knoxville; 2d, if so, are they exclusive and monopolistic in their nature?

On examining the bill I find that the telephone company avers that on Oct. 22, 1880, it was "granted the right and privilege to erect its poles in, over and along the public streets, alleys, lands, roads and public squares of the city, to string its wires thereon, and to use and operate the same for the purposes of telephonic and telegraphic communication;" and that relying on said franchise it has constructed a telephonic plant and is now operating the same.

This averment is the foundation of the telephone company's right and claim to relief; and the truth of this averment is doubly denied by the railroad company, which says that no such franchise was granted and that what was granted was granted to the telephone exchange and not the telephone company. On examining the ordinance of the city I find it reads as follows: "Be it ordained, etc., that the privilege of erecting poles on the public streets and alleys of Knoxville be granted to the East Tennessee Telephone Exchange, and this privilege of erecting posts shall be confined to telephone exchange purposes exclusively. That the posts erected shall in no way interfere with the public travel along the streets, sidewalks and public alleys of the city. That nice posts, straight and smooth, be required, and that the same be in line with the outside edge of the curbing."

To an impartial mind this ordinance does not seem to "grant the right and privilege to erect poles in, over and along the public streets, alleys, lands, roads and public squares of the city." The ordinance confines the location of the poles to the streets and alleys, and says nothing whatever about "lands, roads and public squares;" nor does it say the poles may be erected "in, over and along the public streets, etc.;" it says "on" the streets and "in line with the outside edge of the curbing." Neither does the ordinance say a word about any right "to string

public streets and alleys, . . . this privilege to be confined to telephone exchange purposes exclusively."

It must be remembered that the telephone company does not claim any particular right of way, or strip or piece of ground, or any particular streets or alleys, within the limits of Knoxville, for its earth circuit, but it claims

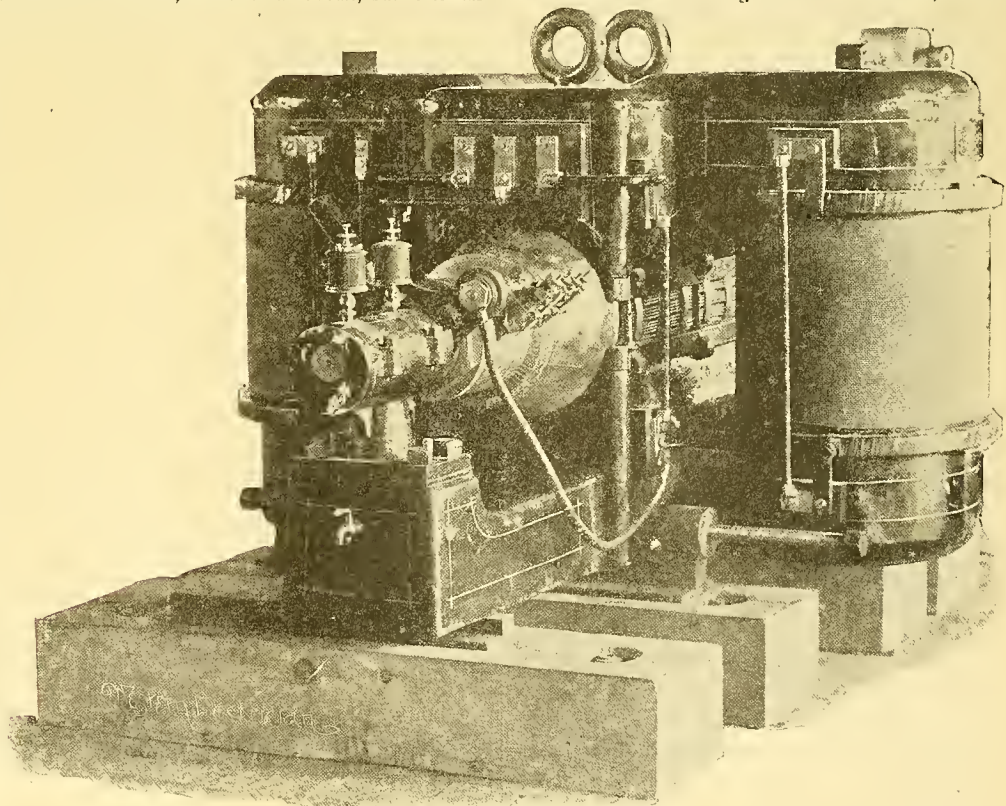

FIG. 2.—RAE GENERATOR.

the whole of the surface of the earth, and all that is beneath the surface of the earth, within the corporate limits, as its exclusive property for all the purposes of an earth circuit.

Now, if at the time this ordinance was passed, any one had suggested that this limited privilege of "erecting poles" gave the Telephone Exchange a right to use all the ground on which the city stood, public and private, as an easement to be used in place of wires, to complete its electrical circuit, he would, no doubt, have been regarded as a wilful distorter of language. But if, in addition, he had claimed that this meager privilege of "erecting poles" not

our cooking, propel all of our vehicles and machinery, and all or a large part of this electricity may be drawn from the earth, or it may be drawn from the air, and yet Knoxville and her people are to be denied all of these wonderful benefits for all the ages to come, if they, either through the earth or through the air, in any way cripple or injure the feeble current of the telephone company, unless the telephone company gives or sells its consent.

The streets of Knoxville are held in trust by the city for the benefit of the people, to the end that the people may

(Continued on page 80.)



# The Street Railway Gazette.

S. L. K. MONROE, - - - - - MANAGER.  
E. V. CAVELL, - - - - - EDITOR.  
EDWARD J. LAWLESS, - - - - - ASSOCIATE EDITOR.  
W. L. S. BAYLEY, - - - - - MECHANICAL EXPERT.

## GENERAL OFFICES:

### CHICAGO:

8 LAKESIDE BUILDING.

AGENCIES } San Francisco, - - - 1222 Bush Street.  
} Toronto (Canada), - - - 53 Magill Street.  
Cable Address=TRAM, CHICAGO.

Annual Subscription (Including Postage).	Per Copy
United States, Canada.....	\$2.00. .... 25c.
Great Britain, Ireland, India, Australia	10s. .... 1s.
Germany.....	9mk. 75 pf. .... 89pf.
France, Belgium, Switzerland.....	2fr. 95c. .... Fr 1.10.
Spain.....	21ps. 95c. .... Ps 1.10.
Austria, Holland.....	6fl. 74c. .... 55c.
Italy.....	12 lire. .... 1½ lra.
Venezuela.....	12 boliv. .... 1½ bol.
Mexico.....	\$3.00. .... 30c.

Annual Subscriptions in Argentine Republic, 2½ peso; Brazil, milreals; Turkey, 54 plasters.

[Entered at the Chicago post-office as second-class matter.]

\*.\*

Matter for publication should reach the Chicago Office not later than the last day of each month. All communications should be addressed, THE STREET RAILWAY GAZETTE, Chicago, Ill.

## Inter-mural Transit.

The immense growth of what is now known as the street railway industry almost passes comprehension—even to those immediately in the field it is a matter of no little difficulty to keep an accurate record of the multitudinous schemes for the construction of street railways which are being originated and pushed forward from day to day.

Scarcely a day passes but what an application for a street railway charter in one city or another is brought to the consideration of city fathers, while we see upon all sides indubitable evidences that capital is seeking investment in the same field.

It is but a very few years ago that it was a very difficult matter for the projector of a street railway to find a market for his bonds; to-day the heaviest financiers are constantly on the lookout for street railway securities as investments. And, in being thus ready to invest their capital in such enterprises, it must be patent to everyone that they but exhibit perspicacity and admirable foresight. Is there a village, a town or a city in this great Union regarding which the coming census will fail to show an increased population?

Such a showing means more travel; it means an enhanced value to real estate; it means an extension of city limits, more earnings, and, consequently, larger dividends to street railway stockholders.

The almost phenomenal success of electricity as a motive power has, undoubtedly, been largely instrumental in bringing about the present activity in street railway construction, and is turning the attention of some of the most brilliant scientists of the day to a solution of the great and important problem of satisfactory inter-mural transit—satisfactory to the public in giving it speedy and comfortable transportation, and, therefore, satisfactory to the stock and bond-holders in ensuring them adequate returns for their investments.

The success of the overhead wire system, as it is now constructed and operated, is fully demonstrated by the fact that almost every road now in operation on that system reports a tremendous increase in travel since its adoption, in some cases amounting as high as 50 per cent.

(Continued from page 79.)

have the right to walk and ride and transport goods and animals, and propel vehicles over and along them. And the city has no right to allow the streets to be used for any purpose inconsistent with these rights of travel and transportation. Telephone poles have no connection with travel or transportation, and have no just rights on our street, and are, at best, mere tenants at will. These doctrines were distinctly recognized by the city when it granted this privilege of "erecting poles," the ordinance emphatically providing that "the posts erected shall in no way interfere with the public travel." It may be said the trouble grows not out of the "posts" but out of the "wires." To this it is answered that the word "wire" is not in the ordinance, and all the right the telephone company has to use wires is as an incident to the post, and what the ordinance means is that neither the posts nor the wires on them shall, in any way interfere with the public travel. In other words, this privilege of "erecting poles" or posts, is to be, in every respect, subordinate to the use of the streets, for public travel. If this be the meaning of the ordinance, then the city has the right to allow electricity to be used as a motor for the propulsion of street cars, and if the telephone poles or wires "interfere with the public travel" on these electric cars, the city has a right to have them removed. And, on this ground, also, it will thus be seen that instead of the telephone company having exclusive and monopolistic rights both to the earth and to the air for electrical purposes, it is a mere humble occupant of the streets, by permission of the city, and liable to be declared a nuisance whenever its poles or wires interfere with the public travel.

Fast, indeed, must our rights be slipping from us, and most insecure, indeed, must be their moorings, when such claims as these are countenanced by the courts. I have, heretofore, declared in a suit between the defendant and the city, that our streets are public property under the trusteeship of the mayor and aldermen, and very slowly and very reluctantly will I ever decide that any of the property of the people has become the fee of any one person, whether such person be a Kentucky corporation or one native born.

I might go further and show that there is no evidence or allegation that the E. T. Telephone Company, a corporation under the laws of Kentucky, is the E. T. Telephone Exchange that acquired this privilege of "erecting poles." The answer denies their identity, and the ordinance supports the answer. In the light of the present claims of this telephone company to the benefit of this ordinance, and to the monopoly of ground on which the city stands, for all the purposes of an earth circuit, I can only say that if such was its object when it secured the apparently humble privilege of "erecting poles," it was seeking to perpetrate a fraud upon the city of Knoxville, whose mayor and aldermen could not have supposed that they were selling the birthrights of their constituents for less even than a mess of pottage. The courts must see to it that no public grants, and no privileges granted, shall so be construed as to deprive the people of any rights or powers except such as are expressly stated or necessarily implied. In applying this rule I hold that the ordinance referred to did not give the telephone company any such exclusive right as it claims; and I am further of the opinion that under its charter powers, and under the corporation ordinance, the Knoxville Street Railroad Company has the right to propel its cars by the single trolley electric system, or by any other the city has authorized or may authorize.

HENRY R. GIBSON, Chancellor.

## LEGAL DECISIONS.

### COURTS OF LAST APPEAL.

REQUISITES OF COMPLAINT.—*Breese v. Trenton Horse Railway Co.*; Supreme Court of New Jersey, Feb. 20, 1890. 19 At. Rep. 204.

On demurrer to complaint the court say:—"A count which alleges that the plaintiff was on 'a car, and it thereby became the duty of the company' to guard, protect and secure the plaintiff while leaving the car, is not good, as it fails to show any facts giving rise to such duty. A count which simply alleges that plaintiff was 'on' a car and that it thereby became the duty of the company to safely and securely carry him, is not good, as the plaintiff might have been on the car as a trespasser. But the count charging in general terms that he was upon the car of the defendant, and by the carelessness of the management of those having it in charge it was run over the body and arms of the plaintiff, while loosely drawn, may stand. It need not appear with much particularity how the tort was committed. On this count the plaintiff is entitled to judgment.

CONTRIBUTORY NEGLIGENCE OF PASSENGER. *Reddington v. Philadelphia Traction company*; Supreme Court of Pennsylvania, February 3, 1890. 19 At. Rep., 28.

The plaintiff in this case was injured while attempting to board an open car on one of the defendant's lines. Plaintiff had his coat over his left arm and his dinner bucket in his left hand, and attempted to mount the car while it was yet

in motion, stepping on the front end and taking hold with his right hand. Just as he was getting on the car the driver released the brake which was partially applied, and its sudden release gave the car a jolt which threw plaintiff to the ground, and he was injured by being caught in the car. Judgment of non suit and appeal by plaintiff. The court say: "According to the plaintiff's own statement of the cause of the accident, he was not entitled to recover. It occurred as he was attempting to get on one of the defendant's cars while it was still in motion. The only alleged negligence of the driver was in loosening the brake when the plaintiff stepped on the car; it may be a jury would have found this to be negligence, but it would have been little short of a burlesque on the administration of the law. The facts being undisputed, the learned judge below did not need the aid of a jury in determining their legal effect." Judgment affirmed.

VALIDITY OF SWITCH PATENT.—*Johnson v. Brooklyn & C. Railway Co.*, Circuit Court of the United States, Eastern District of New York. 40 Fed. Rep. 892.

The Court say:—"This patent was before Judge Coxe in *Johnson v. Railroad Co.*, 33 Fed. Rep. 499. After investigating the state of the art as disclosed by an examination and comparison of the various patents put in evidence in that case, he reached the conclusion that Newman (complainant's assignor) was the pioneer inventor of a combination, being the first to produce a practical horse-railroad switch, which could be operated by the weight of the draught animals oscillating a tip-table, the vertical movement of which is converted by connecting mechanism into horizontal movements of a switch-tongue. Whatever improvements upon Newman's invention are found in the device used by defendants, the latter is plainly an infringement of his patent when thus broadly construed, and the only point left for discussion is whether or not the state of the art will warrant so broad a construction. This, however, has been decided by Judge Coxe, and the only question is whether the new evidence presented in this case calls for any modification of that decision. Several prior patents, not before him, have, it is true, been introduced, but they do not show any more clearly an anticipation of the combination of the Newman patent than did the Sansom and Alexander patents, which were considered in the former case. Decree for complainant."

WHAT WILL CONSTITUTE SUCH A REASONABLE GROUND FOR FEAR AS WILL ENTITLE A PASSENGER TO ALIGHT FROM A MOVING CAR IS A QUESTION OF FACT FOR THE JURY. *Ashton v. Detroit City Railway company*; Supreme Court of Michigan, December 28, 1889. 44 N. W. Rep., 141.

Mrs. Ashton, the plaintiff in this case, took a Russell street car on the line of defendant to go to her home, which was a short distance beyond the end of the line on Ferry avenue. The barns on Ferry avenue were some distance from the end of the line, and when the car approached the barn, instead of carrying plaintiff on to the terminus of the line, the driver turned and drove the car into the barn a number of car lengths, and when she left the car in the barn, who laid hold of her and made indecent proposals to her until she broke away from him and ran to her home, thereby escaping from his further violence and insults. The plaintiff further claims that on a subsequent occasion she was again a passenger on this same line of cars. This time, as before, she intended to ride to the end of the line, and again the car turned into the barn, as it had on the previous occasion. She remembered her experience at that time, and rang the bell to stop the car. Finding that it did not stop, she waited a second, and then went out on the rear platform and got off while the car was in motion, being thrown by so doing, and injuring her knee. She recovered judgment for \$500, from which defendants appealed. The court say: "The Circuit judge was right in receiving the testimony brought out by the question: 'Will you state to the jury what happened when you alighted from



the car in the barn?' referring to the occasion prior to that on which she was injured. This was offered as a reason for justifying her leaving the car while in motion; to show that the place to which she was being taken by the company was one not only improper for ladies, but to the plaintiff it had proved to be dangerous. The fact that the driver did not respond to the ring of the bell was to the lady a suspicious circumstance, and to what extent she had cause to fear and did fear danger approaching as she neared the barn, were proper subjects for the consideration of the jury, and were properly left to them. I think whether or not the treatment the plaintiff received in the defendant's barn when she was taken there was sufficient to justify her belief that she was avoiding an actual impending danger, into which she was being taken, by leaving the car, was a question for the jury and not for the court. It was of no consequence what the car-driver or his company knew or believed in regard to the insult offered to the plaintiff in defendant's barn. The real question was, assuming the testimony of the plaintiff to be true, what reasonable ground had she to expect she would receive insult or injury, and is she to be deemed negligent in doing the only thing which was left for her to do, by the action of defendant, in avoiding such insult and injury?" Judgment affirmed.

VIGILANCE OF DRIVER IN LOOKING OUT FOR PEOPLE ON TRACK.—*Anderson v. Minneapolis Street Railway Company*; Supreme Court of Minnesota, February 10, 1890. 44 N. W. Rep., 518.

This is an action to recover damages for killing a child about three years of age. No question of contributory negligence was raised. The car in question was one upon which no conductor was employed, and hence it was necessary for the driver in addition to other duties to make change for passengers and to see that all passengers paid their fare. While making change in pursuance to his duties to his employer, the accident in question occurred, and before the driver could stop the car the injury had been done. A verdict for defendant was directed, from which plaintiff appeals. The court say: "Unquestionably, so far as the public is concerned, it was the duty of the driver to sit or stand where he can have such control of his team and car as was practicable. The right of defendant to run its cars must be exercised with due regard for the rights for others, and with an appreciation of the knowledge that children as well as adults may lawfully be upon our public ways. The driver may have been doing his duty to defendant when engaged in making change for passengers at a time when he should have been watchful of the rights and careful for the safety of others, but this fact does not absolve the defendant from the charge of negligence. The duty which it and its employees owe to the public is paramount to that which each man owes to the other." Order reversed.

CONSTRUCTION OF STATUTES AND LICENSE.—*Mayor, etc., of New York v. Eighth Ave. Ry. Co.*; Court of Appeals of New York, Jan. 28, 1890. 23 N. E. Rep. 550.

The Court say:—"Under laws N. Y. 1874, c. 478, requiring the Eighth Avenue Railroad company to extend its route, and providing that when the extension shall be completed it shall use and operate its road, 'subject only to the provisions of the general railroad act of this state, with its amendments,' that company is not relieved from its agreement to pay license fees to the city, as laws 1854, c. 140, providing that common councils of cities shall not permit the construction of railroads, beginning and terminating in the city, for transportation of passengers, without consent of property owners on the street, being, *in pari materia*, will be considered as an amendment of the general act, and by this statute the common council is given power when property owners consent, to grant authority to establish a street railroad upon such terms, conditions, and stipulations as it sees fit.

"Though the grant of authority by a common council to operate a street railway on payment of certain license fees was invalid for lack of

authority in the council, yet the grant and contract with the company have been ratified by laws N. Y. 1854, c. 140, under which act, in part, the company was incorporated, the agreement to pay the license also became valid.

"The passage of an ordinance imposing a penalty for failure to procure a license, will not prevent the city from suing for the license fee."

LIABILITY FOR COLLISION WITH VEHICLES.—*Chicago W. D. Ry. v. Ingraham*; Supreme Court of Illinois, Jan. 21, 1890. 23 N. E. Rep. 350.

An appeal from the judgment for plaintiff. The Court say:—"That in an action for injuries caused by collision with a street-car, damages may be recovered both for injuries to plaintiff's person and to his horse and buggy, though they are both set up in the same count of the declaration, when no demurrer is filed, and no objection is made to the introduction of evidence as to such injuries. In such an action, instructing the jury that mere omission to perform any duty is not sufficient to render defendant liable, 'unless such omission caused the injury complained of,' is not reversible error, where other instructions explain the degree of care required of defendant, and state the doctrine of comparative negligence. In such an action, an instruction that a street-car company is entitled to the track on meeting other vehicles, and that the latter should yield the right of the track to the car, is misleading, as indicating that a street-car company is not bound to exercise due care to prevent a collision. In such an action, after a witness has testified regarding the accident, and has been asked on cross-examination, whether he did not say, shortly after the accident, that he could not see the plaintiff, evidence that he said he could not see 'the accident' is admissible, where objection to the form of the statement is not made at the trial.

THE USE OF ELECTRICITY ON STREET RAILROADS.—*Taggart v. Newport Street Railway Co.*; Supreme Court of Rhode Island. 19 At. Rep. 326.

The bill in this case sought to enjoin defendant from operating a railway by electricity along the streets of Newport. The court say:—"The street railway here complained of is operated neither by steam nor horse power, but by electricity. It does not appear, however, that it occupies the streets or highways any more exclusively than if it were operated by horse power. The answer avers that 'electricity, besides being as safe and as easily managed as horse power for the propulsion of street cars, is more quiet, more cleanly, and more convenient than horses, both for residents on the streets used by said cars, and for the public generally, and also causes much less wear and injury to the streets and highways than is occasioned by street cars of which horses are the motive power.' These averments, the case being heard on bill and answer, must be taken as true. We see no reason to doubt their truth. It is urged that electricity is a very dangerous force, and that the court will take judicial notice of its dangerousness. The court will take judicial notice that electricity, developed to some high degree of intensity, is exceedingly dangerous, and even fatally so, to men or animals, when it is brought in contact with them; but the court has no judicial knowledge that, as used by the defendant company, it is dangerous. The answer denies that it is dangerous to either life or property. It is also urged that the cars, moving apparently without the application of external force, alarm and frighten horses. This, so far as it is alleged in the bill, is denied in the answer. We see no reason to suppose that this form of danger is so great that on account of it the railway should be regarded as an additional servitude. The answer alleges that a great many street railways operated by electricity, in the same manner as the railway of the defendant is operated, are in use in various towns and cities in different states, and that many others are in process of construction. Reference has been made to cases which hold that telegraph or telephone poles and wires erected on streets or highways constitute an additional servitude, entitling the owners of the fee to additional compensation; and from these cases it is urged that

the railway here complained of is an additional servitude, by reason of the poles and wires which communicate its motive powers. There are cases which hold as stated, and there are cases which hold otherwise. But, assuming that telegraph and telephone poles and wires do create a new servitude, we do not think it follows that the poles and wires erected and used for the service of said street railway likewise create a new servitude. Telegraph and telephone poles and wires are not used to facilitate the use of the streets where they are erected for travel and transportation, or, if so, very indirectly so; whereas the poles and wires here in question are directly ancillary to the uses of the streets, as such, in that they communicate the power by which the street cars are propelled. It has been held, for reasons which we consider irrefragable, that a telegraph erected by a railroad company, within its location, for the purposes of its railroad, to increase the safety and efficiency thereof, does not constitute an additional servitude, but is only a legitimate development of the easement originally acquired. *Telegraph Co. v. Rich*, 19 Kan., 517. Our conclusion is that the complainants are not entitled to the relief prayed for on the ground alleged, and that the bill be dismissed with costs."

UNDER THE FACTS STATED CONTRIBUTORY NEGLIGENCE HELD TO BE A QUESTION FOR THE JURY. *Little v. Grand Rapids Street Railway Company*; Supreme Court of Michigan, December 28, 1889. 44 N. W. Rep., 136.

Plaintiff, while digging in a sewer-connecting ditch in a street in Grand Rapids, was struck in the back by the projecting foot-board of an open passenger street car and was badly injured. He sued defendant, and the defense was based on allegations of contributory negligence. The court took the question from the jury and directed a verdict for defendant, and from a judgment in accordance therewith plaintiff appeals. The court say: "That the driver of the street car was negligent is hardly questioned, and negligent to a gross degree, not only in driving very fast but in doing so without keeping any lookout ahead whatever. The only question is whether plaintiff was so unequivocally negligent that there were no facts for the jury. It is not disputed that he was engaged in a lawful work and he was doing it in a lawful way. It was like all other manual work, such as required his attention to do it properly. He had also a right to expect that the cars would not be run in any unusual way or carelessly. It was also his own duty to keep a reasonable degree of care on such perils as were incident to the work, as it was that of defendant to avoid any careless interference with the rights of those lawfully working near the track, and to avoid doing any mischief. Plaintiff swore positively that he did not hear the car coming. Although there was some conflict, there was evidence which indicated that there were street noises which deadened the sound of the car, such as it was. Several witnesses who had the same opportunity as plaintiff, if not better, swore they did not hear the bells or any other noise that drew their attention. Plaintiff swore, and is corroborated in the statement, that he looked toward Hall street at intervals, and did not see the cars, when, if they had been going at the usual rate of speed they would have been some distance nearer than the corner. Defendant introduced no testimony at all, and in order to convict plaintiff of negligence, it was necessary to assume that he must have heard what other unimpeached witnesses did not hear, or seen what they did not see. To assume, in the face of testimony to the contrary, that there were bells that made such a noise as should have given warning of their coming to all persons, or that the noises of the street must have had no effect in deadening the noise of the car in its approach, is to go beyond the province of the court, and prevent the jury from passing on pertinent facts. That plaintiff took some precautions is shown affirmatively. It was for the jury to say whether, under all the circumstances, he was so remiss that failure to actually hear or see the car in its approach, so as to avoid it, is his own fault, so as to make him responsible for his own hurt." Judgment reversed.



### Cable Railways--Their Defects and Remedies.

That so rapid an evolution from the primitive devices first used for traction purposes to the most powerful, most economical motor of street railway traffic in the world should, of necessity, entail marked defects in construction, if not in operation, goes without saying; we propose to try to specifically detail those defects and succinctly point out their economical remedies.

#### I.

First in unusual importance is the great question of the employment of labor. Were we not able to secure a sufficiency to carry on our great industries, the law of supply and demand would quietly settle the question; but when and where there is a glut of labor offered, it is the political and moral right of American labor to demand first recognition in any and all branches of trade and commerce. By American, we refer to our citizens, whether born on this soil or claiming their share of the rights inherently ours by adoption.

#### II.

Preliminary to construction comes the collection of financial data. This is not, as many would imagine, a difficult problem. Each household within your proposed territory will certainly pay for transportation, each year, a sum so nearly amounting to twenty five dollars that that has come to be regarded as a basis for income calculations.

#### III.

##### CONSTRUCTION MATERIAL.

In construction material, the use of Portland cement concrete seems to be considered indispensable, and perhaps this is true if better material is not at our door offering its services at vastly less cost and ready to insure one hundred per cent. better results. To give facts: One immense corporation has builded its conduits or channel walls of Portland cement concrete, with an average thickness of eight inches in every part. If the work were honestly done, the expense would be so enormous as to appal less favored enterprises; while another, nearly as powerful, cable company has adopted the three-sixteenth-inch steel shell, backed by what appears to us to be an inferior grade of concrete. This, during the life of the shell, would not seriously affect the construction. But a mere reference to the fact that the engineers do not expect to be able to rely on the life of the steel, thus exposed, as being more than ten years, will compel attention to the concrete backing, and such investigation, we opine, would not result favorably to its use. We believe that the shocks of wheel traffic will shatter the mass even before moisture has given ample facilities for destruction. No concrete, as such, has been, or is, free from this serious evil. The amount of concrete, such as it is, used for backing the steel shell's is quite equal, in dimensions, to the channel where no shell is used; but it is not claimed to be of as good a quality. At best, concrete is but an inferior limestone product; but is its use financially legitimate? This costly product can not be manufactured economically by such methods.

The item of waste alone, on the streets of a windy city, is enough to cause capital (properly understanding the subject) to shrink from the venture. All capitalists see the immense possibilities of the cable railway but are generally appalled at the estimated expense. It is for this reason that the GAZETTE offers for their consideration a substitute, if not of material, certainly in form. We propose cement, terra cotta and brick, cast in forms to suit, which, when in place, will occupy not to exceed a thickness of two inches, a length equal to the space which the location of the yokes requires, and a semicircular depth equal to the requirements of cable service and a proper drainage. Let us consider the claims of each material in the order above named. The best of Portland cement and a manufactured sand, crushed from commercially pure quartzites, obtainable in inexhaustible quantities in the Chicago and other markets at a price not exceeding four dollars per cubic yard, would give you a concrete shell which can be put in place for less than one-third of the cost by the old methods. But while we are confident that this would resist frost effects, on account of its superior compactness, yet as this is not assured by experience we

are next led to consider the claims of terra cotta dipped in an asphaltum or coal tar bath. This coating would make the material, wonderfully light and porous, non-absorbent, while it has a thousand elements of value to commend it to the attention of capitalists, while its cost would be somewhat less than the Portland cement shell and its years of service endless. These considerations place it in the van of cable materials. Brick. In recommending brick shells we refer to the product generally known as vitrified material; a material largely made up of iron and fire clay. This is fast becoming popular for street paving, sidewalks, floors and tiling. It has a crushing resistance of nearly thirty thousand pounds and is readily cast in any required form, with air cushions, dovetails, openings for drainage and for the location of miniature tramways, serving as carriages for the carrying pulleys of the cable. This material is found in inexhaustible quantities in Cook and other counties in the West, although distinctly exclusive in its bed from common clay. There is one division within twenty miles of Chicago with a superficial area of five hundred and twenty acres and an unknown depth. Breakage, inconsiderable at any time, is quickly repaired by cement mortar. The cost of this material is even less than terra cotta, because it would have no government protection in form of a patent.

#### IV.

##### CARRYING PULLEYS.

Having considered conduit materials, let us look within, to those vital but neglected adjuncts which are relied upon to transmit power. As now, or rather then, constructed, they have a dead weight of nearly fifty pounds, and when coated with filth, which their construction seems especially to invite, they add at least ten per cent to their normal weight. They are set by the same alien labor, to which we make no apology for so often referring, and, to sum up briefly, are the most unmechanical makeshifts which were ever relied upon to do such important service. As a remedy for these pioneer devices the GAZETTE advocates a five-inch steel-rimmed pulley with a thickness of three-sixteenths of an inch and an aggregate weight of only twelve pounds. A grade of steel is now manufactured which does not oxydize and its extra cost is a mere bagatelle when you consider the power which is consumed in the propulsion of an idle cable.

#### V.

##### THE POWER AND ITS LOAD.

The art imitative has much to answer for in this regard, and no hereditary disease is more difficult to eradicate than the conditions which the size of the grip entails upon the relations of the power and its load. That twenty-one inches from grade for the cable rest should have proved not a barrier to the "go" of the system, is the strongest evidence of the justice of the claims of cable engineers. If an arm's length pull can outstrip all other motors, what may we not expect when they are brought into true mechanical relations?

The Remedy.—Build the grip of the finest of steel and brass, thus reducing its weight one-half, and one of the most difficult problems of economical rapid transit will have been solved. Raise the grade of the carrying pulleys to twelve inches below, build the grip car frame of steel, and in these regards cable service will be economically and rapidly given.

#### VI.

##### WHEEL OR TRANSFER PITS.

Thirty inches for roof purposes in the form of raisers, with brick and concrete filling, is not only a very expensive method of restoring the street to its legitimate uses, while securing transfer conditions below, but compels the location of the turning sheaves so low as to entail unhealthy cable conditions—conditions which compel the cable to twist and untwist in its effort to reach its service point on its ceaseless rounds. The remedy is to build in the shop, from or with fifteen-inch I beams, a roof, which, when in place, arched with steel plate and concrete filling, without brick, will save you fifteen inches of the most costly space which cable construction entails. The time in which this construction of a roof could be put in place is invaluable when the rights of wheel traffic are considered.

#### VII.

##### POWER AND POWER HOUSES.

Such is the legitimate prestige which the mechanical engineer has justly earned, that a novice may be chary in his efforts to point out defects, even though they exist. Vast improvements in steam manufacture and uses are of almost daily occurrence and capital can be safely depended on to adopt all the good things offered, especially assisted, as it is, by a long line of builders and workers, each in his own line capable of a sturdy and intelligent investigation and a quick adoption of that which, to them, seems best adapted to the purposes it is intended to serve. Yet more room is imperatively called for in the engine house and wheel pits. It is unreasonable to expect steam handlers to be jammed too closely between the upper and nether swiftly flying lines of machinery.

#### VIII.

##### LINES, CURVES AND GRADES.

Of lines not much is required to be said, because they are almost always arbitrary conditions imposed by municipal regulations except where the construction lines are along the center of broad avenues. It is well known that rarely can a perfectly straight line be secured for more than a single half mile, but the engineer, by trial, will find on wide streets that the course of each half mile, as related to another, is a zigzag; hence on a line of three miles you will find a mean or average location, which, while it secures to you the advantages and beauty of a perfectly straight line for the whole length, it does so without practical prejudice to the rights of the city.

Curves are the most costly hindrances, as constructed, except the carrying pulleys and sheaves, with which we have to contend. To make square-cornered returns to the city's sidewalks is not only unsymmetrical but is a costly hindrance to the successful operation of the cable machinery and the wheel traffic of the city. The remedy: Turn the sidewalk corner on a radius equal to the width of the widest intersecting walk and take sixty or eighty feet for your curvature instead of the forty-five now so common, thus saving a terrible bill of expense which is continuous for all time.

Grades.—Where you can get grades for the cable they are very desirable. They absolutely cost nothing and are, by their novelty, valuable financial conditions. These conditions are, in every known sense, remunerative, while a reciprocal arrangement of the car service, for a counterpoise, makes the operation of the cable non-expensive. It is to be regretted that few of our cities have a "Clay Hill;" hence may be obliged, for a financial novelty, to take an "Eiffel." Do we doubt the building of a cable railway to such a resort when it shall come?

#### IX.

##### THE METAL SHAPES USED IN THE CONSTRUCTION OF CABLE RAILWAYS.

The rails, as now manufactured by a few great firms, are as near perfect as we could reasonably ask, and we only call attention of our readers to a few items of interest. First, an extended web, for paving purposes. We think that the object sought is not better attained thereby and when attained is not an improvement upon legitimate shapes. These manufacturers are thoroughly reliable and would give you the best material for the purposes required. The market does not offer in shapes for curves any thoroughly good designs. In this they are away behind straightway material. In fact, to sum it up, we find a natural antipathy between the curves and the rolling stock. This is a very costly condition. Fifty years behind may be said to be the best shapes in switches and cut-offs. The remedy consists in giving to these shapes their legitimate proportions of the curvature of which they are so vital a part. "Be sure you are right and then go ahead" seems never to be true of the work on these appliances.

NOTE.—Thousands of these errors have been condoned by the remark that "it is only a street railway; it's good enough, and the income is so great that it will not pay to meddle with it." The peculiar shape of the slot or Z iron has been forced upon us by the use of the cumbersome grip, and the peculiar paving conditions have also had their origin in the same cause.

(To be continued.)



**STREET RAILWAY NEWS.**

See also "New Enterprises," "Extensions," "Elections," etc.

The following data is compiled with all possible care, but the publishers, receiving news as they do, from almost every state, territory and country, cannot be held responsible for errors, as it would be wholly impossible to obtain a verification of each item received by them in time for each issue

**ALABAMA.**

**Gadsden**—The Gadsden Land & Improvement company has sold its property to J. M. Elliot, Jr., and his associates, for \$21,000.

**ILLINOIS.**

**Aurora**—We understand that parties are endeavoring to buy the Aurora Horse Railway, and should they be successful, electricity will be adopted in the immediate future.

We understand that the City Railway company has decided to put in a \$250,000 Thomson-Houston electric railway system. Twenty miles is the extent contemplated, and ten miles will be constructed this season. Drexel, Morgan & Co., of New York, are backing the enterprise.

**Peoria**—We understand that the Fort Clark Street Railway is for sale.

The Central Railway company, of this city, has contracted for an additional equipment of three 80 h. p. generators.

**INDIANA.**

**Anderson**—An ordinance has been introduced into the council granting a franchise to Messrs. Sam Hodson, of this place, and S. J. Jones, of Ohio, for the construction of a street railway. If the franchise is granted, the company agree to have its line—2½ miles long—in operation within twelve months.

(There is already one street railway company here.)

**Evansville**—The Evansville Street Railway company has now passed into the control of Messrs. Hathaway & Robinson, of Cleveland, Ohio.

**IOWA.**

**Dubuque**—After a persistent fight, Major A. J. Rhomberg has been granted his charter, and the Dubuque Street Railway is empowered to erect poles, and adopt electricity as motive power.

**KANSAS.**

**Arkansas City**—The city street car stables were destroyed by fire on the 9th ultimo, and the loss was in the neighborhood of \$18,000, on which there was a nominal insurance of \$5,000.

**MARYLAND.**

**Baltimore**—Information reaches us from this point that northern capitalists are negotiating for the purchase of the Pimlico and Arlington Horse Railway. If the deal is consummated the road will, it is said, be made an electric railway. The road will be run at first only to Pikesville, the present terminus. Later it will go to Green Spring Valley. A connection with the Pimlico grounds will also be built. The road passes through a beautiful country, which is being steadily improved.

**MASSACHUSETTS.**

**Fair Haven**—We understand that electricity will be adopted on the lines of the street railway here.

**Lowell**—The Lowell & Dracut Street Railway company has received permission from the board of railroad commissioners to increase its capital stock \$100,000.

**Lynn**—The Lynn Belt Line Street Railroad company has mortgaged its plant, in Lynn, for \$100,000 to the American Loan & Trust company, in order to secure the issue of first mortgage bonds at four per cent.

**Natick**—The electric company has a petition signed by 618 voters, asking that it be granted the franchise to build a street railway.

**Salem**—Mr. David N. Cook has been elected superintendent of the Essex Electric Street Railway company.

**MINNESOTA.**

**Duluth**—At a recent meeting of the city council, the street railroad company outlined its plans for the coming year, which call for the expenditure of about \$500,000, and waived the question of changing the gauge of the tracks. The council committee reported an ordinance, which was passed by a vote of 11 to 1, giving the company the right to erect its poles and string its wires on Superior and 4th streets, and

such streets and avenues as are necessary to connect the lines. It places several restrictions and conditions on the company, such as widening tracks to the standard gauge, compelling the grading and paving between tracks, the payment after five years to the city of \$5 annually on each car owned and run by the company, and two per cent. on the gross earnings. The ordinance must be accepted in thirty days. It is not satisfactory to the company, and it is not known whether it will be accepted or not.

**MISSOURI.**

**Garthage**—The Garthage Street Railway company has now passed into the control of L. D. Dougherty and G. D. Sleever, of Waco, Texas. The consideration was \$20,000.

**Hannibal**—We understand that electricity is about to be adopted on the present horse car line here.

**Kansas City**—The Kansas City and Blue Valley Railway company has decided to increase its capital stock from \$50,000 to \$75,000, for the purpose of carrying into effect the proposed improvements regarding the adoption of electricity and an extension of tracks. The contract for the proposed Centropolis line is in the hands of W. B. Knight.

**St. Louis**—Mr. Augustin W. Wright, of Wright & Meysenburg, has closed a contract with the Broadway line here to furnish all the labor, material, etc., and to superintend the engineering of about fifteen miles of cable road. The estimated cost of the re-construction of the road is in the neighborhood of \$300,000.

The Lindell Street Railway company reports that during the last quarter its cars made 107,014 trips, and carried 1,175,094 passengers.

The Mound City Street Railway company reports that during the last quarter its cars made 49,354 trips, and carried 518,240 passengers.

The Jefferson Avenue company reports that during the last three months its cars have made 63,924 trips, and have carried 340,672 passengers.

The Union Depot company reports that during the past three months its cars have made 79,732 trips, and has carried 1,194,135 passengers.

The Citizens Street Railroad company reports that during the last three months its cars have made 83,334 trips, and has carried 1,617,935 passengers.

The Northern Central company states that its cars have made 41,702 trips, and has carried 490,022 passengers during the first three months of the year.

The Cass Avenue company reports that during the last three months its cars have made 50,882 trips, and carried 751,172 passengers.

The Union Line reports that during the last three months its cars have made 62,550 trips, and carried 487,560 passengers.

The St. Louis Line reports that during the last three months its cars have made 56,502 trips, and carried 1,695,080 passengers.

**NEBRASKA.**

**Norfolk**—The Street Railway company here has authorized its president, Mr. C. B. Burrows, to purchase several new cars.

**NEW JERSEY.**

**Jersey City**—The North Hudson County Railway company has purchased the Pavonia Horse Railway.

The Jersey City and Bergen Street Car company has signed an agreement with the Jersey City Electric Light company for a supply of power with which to run its cars in Montgomery street.

**NEW YORK.**

**Amsterdam**—It is rumored that a syndicate of New York capitalists is negotiating for the purchase of the Amsterdam Street Railroad company's property, with a view of converting it into an electric road.

The Amsterdam Street Railroad report for the first quarter of this year shows the gross earnings from operations as \$995,50, operating expenses as \$1,040,91, and loss for quarter of \$45.

**Brooklyn**—The following is the report made the Railroad Commissioners by the Brooklyn City Railway for the first quarter of 1890:

Gross earnings, \$697,492; operating expenses, \$582,931; net earnings, \$114,561; fixed charges,

\$70,700; net income, \$43,861. The net income a year ago was \$23,885. The amount of cash on hand is shown to be \$490,091, and the profit and loss surplus, \$401,585; capital stock, \$6,000,000, and funded debt, \$800,000.

**Geneva**—Several capitalists have petitioned the trustees of the village here for a franchise to construct and operate an electric street railway.

**New York City**—The Metropolitan Cross Town Railway company has mortgaged its rolling stock, franchises, etc., to the New York Security and Trust company for \$600,000.

The following is the report made the railway commissioners by the New York & Harlem (city line) Railroad company, for the quarter ending March 31st, 1890:

**New York and Harlem, (City line).**—Gross earnings, \$235,822; operating expenses, \$141,814; fixed charges, \$5,974; net income, \$88,034. For the corresponding quarter last year the gross earnings were \$207,051 and net income \$69,014.

**Rochester**—The Rochester Railway company has executed a mortgage for \$10,000,000 in favor of the Solicitor's Loan and Trust Co., of Philadelphia, in order to secure the payment of 3,000 five per cent bonds of \$1,000 each. The interest is payable semi-annually.

**Syracuse**—All of the street railway companies of this city with the exception of the Peoples and Central City lines, have passed into the hands of a syndicate of which Mr. Louis Marshall is at the head. There is very little doubt but that electricity will be adopted on the lines controlled by the syndicate.

**Utica**—President J. F. Mann of the Bleeker Street Railroad has contracted with the Utica Electric Light & Power company for power sufficient to operate his railway system.

We understand that President Mann of the Utica & Mohawk Street Railroad has awarded the contract for the equipment of his line to the Sprague company. The contract calls for five motor cars. (We have not received any details from the Sprague company regarding this matter.)

**NORTH CAROLINA.**

**Hendersonville**—A street car line is now in operation at this point.

**OHIO.**

**Cincinnati**—The Mount Auburn Cable Railway company, of which Mr. Henry Martin was president has increased its capital stock to \$600,000 and has authorized the issue of an increase of bonds to a like amount; the proceeds resulting from placing of the same are to be used in betterments and extensions

In spite of many predictions to the contrary the property of the Mount Auburn Cable Railway company is in a highly prosperous condition, and it would not surprise us if the stockholders were to get very good returns for their investment.

The company recently received the following curious letter which will tend to show the variety of claims made against similar corporations:

"MT. AUBURN CABLE RAILWAY COMPANY, Cincinnati, O.  
Gentlemen: My little daughter is very much grieved over the loss of her little pet pug which one of your cable cars ran over this morning about 8 o'clock. She saved up her money to the amount of \$20 in order to buy and feel you might be able to replace it or at least help to.  
Yours respectfully, \_\_\_\_\_"

**Zanesville**—The Zanesville Street Railway company is endeavoring to secure right of way for a new road on North River street.

**OREGON.**

**Albany**—We understand that at a recent meeting of the stockholders of the Albany Street Railway company the directors were empowered to file supplementary articles of incorporation, and also that five or more miles of new track will be built during the coming summer. It is probable that electricity will be adopted as motive power.

**PENNSYLVANIA.**

**Lancaster**—We understand that a movement is on foot to connect this city with Strasburg by means of an electric railway.

**Philadelphia**—A strong effort is being made toward the adoption of double deckers on certain street railways here.

**RHODE ISLAND.**

**Woonsocket**—The annual meeting of the Woonsocket Street Railway company was held



on the 17th ultimo. The principal business brought before the meeting was a discussion of operating the road by electricity. A new board of directors was elected, a list of which, together with the officers, appears under head of "Elections" in present issue.

#### SOUTH CAROLINA.

**Columbia**—Mr. E. A. Buck, of Chattanooga, is interested in an electric street railway project here.

#### TEXAS.

**San Antonio**—New York and Chicago capitalists have bought the property of the San Antonio Street Railway company, consisting of 70 miles of track, together with cars, mules, stables, etc. We understand that the purchase price was in the neighborhood of \$1,500,000.

#### VIRGINIA.

**Lynchburg**—The Lynchburg Street Railway has been sold to a New York company. It is the intention of the new owners to transform the road into an electric line within a reasonable time after they take possession and extend it to West Lynchburg.

#### WASHINGTON.

**Seattle**—The Yesler avenue and Jackson street cable roads have passed into the control of the Lake Washington Cable Railway company, the consideration being \$600,000.

#### WISCONSIN.

**Milwaukee**—The Belle City Street Railway company has increased its capital stock from \$75,000 to \$100,000.

It is announced that operations on the proposed electric line between this point and Wauwatosa will be commenced at once and it is expected that the road will be in operation by September 1st.

The receipts of the Cream City Railway company, which recently passed into the hands of new men show that from January 1st to April 21st this year, \$52,658.12 were earned; the expenses for the same time being \$37,311.06, making the net earnings \$15,347.06. A dividend of 153 per cent, payable at once, was declared by the directors.

## NEW ENTERPRISES.

#### ALABAMA.

**Greenville**—The Greenville Street Railway has been incorporated. A list of the officers and directors will be found under head of "Elections" in present issue.

#### ARKANSAS.

**Little Rock**—The Little Rock Street Railway company has been re-organized into a new corporation, which will hereafter be known as the Capitol Railway company. A list of the new officers will be found under head of "Elections" in present issue.

#### CALIFORNIA.

**Haywards**—Mr. H. W. Meek, who obtained a franchise some time ago for a street railway, has commenced operations along the route. Electricity will probably be adopted as a motive power.

#### ILLINOIS.

**Alton**—We understand that a line will be built from this point to North Alton, a distance of three miles, and that a company with a capital stock of \$20,000 has been incorporated for the purpose of building the road.

**Bloomington**—The Bloomington & Normal Street Railway company and the Bloomington City Railway company have been consolidated under the corporate name of the Bloomington City Railway, with a capital stock of \$600,000.

**Chicago**—The Forsyth Elevated Railway company has been incorporated with a capital stock of \$5,000,000, for the purpose of constructing an elevated road from a point on the Illinois and Indiana State line, in Cook county, to Chicago. A list of the first board of directors will be found under the head of "Elections" in present issue.

#### INDIANA.

**La Porte**—It is rumored that an electric street railway will be built here in the immediate future.

#### MAINE.

**Augusta**—An electric railway between this point and Gardner is to be built at once.

#### MASSACHUSETTS.

**Milford**—The Milford and Hopedale Street Railway company, capitalized at \$60,000, has been organized. A list of the officers, etc., will be found under head of "Elections" in present issue.

**Quincy**—The Manet Street Railway company has been incorporated, with a capital stock of \$35,000. A list of the incorporators will be found under head of "Elections" in present issue.

#### MINNESOTA.

**Duluth**—The Duluth Electric Railway company has been incorporated with a capital stock of \$200,000. The incorporators are R. Myers, H. H. Myers, B. F. Myers, W. Saeger and F. W. Payne.

#### NEW JERSEY.

**Elizabeth**—The Union County Street Railway has been incorporated with a capital stock of \$100,000.

Among the incorporators are Thomas C. Barr, who owned the greater part of the stock; A. Q. Keasbey and John N. Ackerman, of Newark, and Frank Bergen, of East Orange.

The road, when built, will have from three to four miles of track.

#### NEW YORK.

**Geneva**—A franchise has been granted for the construction of an electric street railway here, which must be completed within six months.

#### OHIO.

**Cleveland**—The Cleveland Belt Line Railroad company, of this city, has been incorporated.

**Columbus**—The Glenwood and Green Lawn Street Railway company has been incorporated, with Col. A. D. Rogers as president, and R. S. Rickly, secretary.

#### PENNSYLVANIA.

**Du Bois**—A charter has been applied for for the construction of an electric street railway, to run between the Allegheny Valley depot and that of the Buffalo, Rochester & Pittsburgh. The estimated cost of the road is \$75,000.

**Pittsburg**—The Grant Street Railway has been incorporated with a capital stock of \$3,000, to build a street railway one mile in length. A list of the directors will be found under head of "Elections" in present issue.

The Exchange Street Railway company, capitalized at \$100,000, has been incorporated to build a line 400 feet long. A list of the directors will be found under head of "Elections" in present issue.

The Riverside Street Railway company has been incorporated with a capital stock of \$1,800, to build a line  $\frac{3}{4}$  of a mile in length. A list of the directors will be found under head of "Elections" in present issue.

The Monongahela Street Railway company has been incorporated to build a line one mile in length; the capital stock is \$6,000. A list of the directory will be found under head of "Elections" in present issue.

We understand that an electric railway will probably be built, in the near future, to Troy Hill; the backers of the proposed scheme are Messrs. John P. Ober, Herman Straub, C. Walters, Mark Einstein, and others, of Allegheny City. It is expected that the road, if built, will be a feeder for the Pleasant Valley system, and in direct opposition to the Pittsburg, Allegheny & Manchester's present line.

It is estimated that \$100,000 will have to be invested in the scheme in order to push it to completion within one year after right of way is granted.

**Sharpsburg**—It is rumored that the Citizens' Traction company will build a line between here and Pittsburg in the immediate future.

#### UTAH.

**Provo City**—A street railway is to be built here in the immediate future.

#### WASHINGTON TERRITORY.

**Aberdeen**—A cable railway has been projected to run from this point to Hoquiam; Mr. I. L. Head, of Aberdeen, is interested. The capital stock of this enterprise is \$150,000, and the trustees are J. B. Metcalfe, L. J. Weatherwax, J. S. Kloeber and H. B. Lind.

**Irontdale**—We understand that a company has been organized for the purpose of building an electric road between this point and Port Haddock.

**Port Townsend**—Articles of incorporation of the Port Townsend Belt Line Electric Railway, with a capital stock of \$150,000, have been filed with the county auditor.

#### WISCONSIN.

**Milwaukee**—A franchise has been applied for by the National Home and North Greenfield company. The following gentlemen, of Milwaukee, are interested: Paul Bechtner, Hugo Loewenbech, F. W. Henderson, H. T. Moore, W. D. Gray, G. N. Hickley and C. E. Danner. The capital stock is \$100,000.

**Sheboygan**—The Sheboygan City Railway company, limited, has been incorporated with a capital stock of \$50,000. The incorporators are J. M. and Franklin I. and Sarah C. Talman.

## EXTENSIONS.

**Amsterdam, N. Y.**—We understand that, if the syndicate of New York capitalists now negotiating for the purchase of the Amsterdam Street Railroad company is successful in its endeavors, the road will be extended in the immediate future.

**Anniston, Ala.**—The Anniston Street Railway company will be extended at once.

**Athens, Ga.**—The Athens Street Car company will probably extend its line to Lilly Park at once.

**Bangor, Me.**—The electric railway here will be extended to South Brewer during the year.

**Binghamton, N. Y.**—The electric road will be extended to Sturges street north of the railroad.

**Davenport, Ia.**—The electric street railway here is being extended.

**Fitchburg, Mass.**—The directors of the street railway company here have under consideration the advisability of extending the line to Leonminster. If the line is extended electricity will probably be adopted.

**Greenville, S. C.**—The Greenville Street Railway has decided to extend its tracks for the distance of about one fourth of a mile.

**Hamilton, Mass.**—News reaches us from this point that the Naumkeag Street Railway company has been asked to extend its tracks to Tuttle's Corners—about two miles.

**Joliet, Ill.**—Within the next two months the Joliet Street Railway company will extend its line about two miles.

**Kansas City, Mo.**—The North East Street Railway company has been extended eastward for a distance of about one mile.

**Laconia, N. H.**—The Laconia & Lake Village Horse Railway company will extend its tracks at once.

**Lincoln, Neb.**—Work on the extension of the Wesleyan University Street Railway line has been commenced.

**Muskegon, Mich.**—The Street Railway company here will extend its line to the lake during the summer.

**Natick, Mass.**—The Natick & Cochituate Street Railway company will extend its line to West Natick and from South Framingham to the Wellesley line.

**Nebraska City, Neb.**—The Street Railway here will extend its tracks at once a short distance.

**North Andover, Mass.**—A petition is in circulation for the extension of the Merrimac Horse Railroad to the historic Centre. It is being numerously signed, over one hundred signatures being now on the document, which will be presented to the officials of the road within a few days.

**Peoria, Ill.**—The Central Railway Company will extend its line six miles at once.

**Reading, Pa.**—The City Passenger Railroad company is extending its Tenth street track.

**Salt Lake City, Utah**—The Electric Street Railway company here is about to undertake an extension of its lines.

**Stockton, N. J.**—The street car company here will probably extend its line at once to Pavonia Park.

**Taunton, Mass.**—The street railway company here will extend its line at once.

**Waverly, Ore.**—The Waverly, Kenilworth & Woodstock Electric Railway is to be extended for about one mile.



ELECTIONS.

**Brooklyn, N. Y.**—At a recent meeting of the Atlantic Avenue Road, the following named gentlemen were elected as directors for the ensuing year:

William Richardson, Frederick A. Schroeder, Newberry H. Frost, Benjamin F. Tracy, Samuel W. Browne, James H. Kirby, Augustus Storrs, John G. Jenkins, William J. Richardson, William F. Redmond, Joseph O'Brien, William H. Wallace, and David W. Binns.

The officers of the Grant Street and Newtown Street Railway company, which has now passed into the control of the Brooklyn City Railway, are as follows:

President—D. F. Lewis.  
Vice-President—E. V. White.  
Treasurer—Crowell Hedden.  
Secretary—H. M. Thompson.

**Charleston, S. C.**—At a recent meeting of the stockholders, of the Middle Street and Sullivan's Island Railroad company, the following named gentlemen were elected as officers:

President—B. Callaghan.  
Secretary and Treasurer—Frank B. Whilden.  
Solicitor—C. A. McHugh.

Directors—B. O'Neill, B. F. McCabe, John S. Riggs, M. Triest, Patrick Moran and F. Q. O'Neill.

**Chicago, Ill.**—The first board of directors of the recently incorporated Forsyth Elevated Railroad company, consists of the following named gentlemen:

Jacob Forsyth, Sheffield, Ind.; John J. Forsyth, Sheffield, Ind.; George W. F. Forsyth, Sheffield, Ind.; Oliver O. Forsyth, Sheffield, Ind.; and Henry F. Moore, Chicago.

**Essex, N. J.**—At a recent meeting of the Essex Passenger Railway company, the following named gentlemen were elected as directors:

Thomas C. Barr and Edward E. Dennison, of Philadelphia; S. S. Battin, John H. Ballantine, Robert F. Ballantine, Theodore Runyon, Alfred L. Dennis, F. Wolcott Jackson, and William Clark, of Newark.

**Fort Scott, Kan.**—The present officers of the Davenport and Fort Scott Investment company, which obtained control of the Bourbon County Street Railway, in January, are as follows:

President—E. W. Brady.  
1st Vice-President—U. B. Pearsall,  
2d Vice President—D. B. Burger.  
Treasurer—A. L. Hughes.  
Secretary and Asst. Treasurer—S. P. Mosher.  
Assistant Secretary—C. A. Nebeker.  
Attorneys—J. H. Richards, J. W. Stewart.

Directors—E. W. Brady, J. W. Stewart, A. B. Brady, A. L. Hughes, Wm. M. Smith, Davenport; J. H. Richards, D. B. Burger, U. B. Pearsall, S. B. Mosher, Fort Scott.

**Greenville, Ala.**—At a recent meeting of the stockholders of the Greenville Street Railway company, the following named gentlemen were duly elected as officers and directors for the ensuing year:

President—R. E. Steiner.  
General Manager—J. T. Steiner.  
Directors—R. E. Steiner, A. Steinhart, J. T. Steiner, T. W. Peagler, A. C. Winkler, Chas. Neumann and W. J. Dunklin.

**Little Rock, Ark.**—At a meeting of the recently organized Capitol Street Railway company, of this city, the following named gentlemen were elected:

President—H. G. Allis.  
Vice-President—G. B. Rose.  
Secretary and Treasurer—H. P. Bradford.  
Directors—Messrs. Allis, Brown, Stanners, Taylor and Rose.

**Milford, Mass.**—The officers of the recently organized Milford & Hopedale Street Railway company are as follows: President, E. P. Usher of Grafton; Secretary, F. W. Morse of Grafton; Directors, E. P. Usher, F. W. Morse, Gen. W. F. Draper of Manchester.

**New Haven, Conn.**—At a recent meeting of the stockholders of the Southington and Plantsville Tramway company, the following named gentlemen were elected directors for the ensuing year:

Dr. James H. Osborne, C. K. Weall, of Hartford, Stephen Walkley, H. M. Linnell, of Hart-

ford, M. B. Willcox, R. W. Cowles and L. E. Southworth.

**Newark, N. J.**—At a recent meeting of the Newark and Irvington Street Railway company, the following named gentlemen were elected as directors:

Thomas C. Barr and Edward E. Dennison, of Philadelphia; S. S. Battin, John H. Ballantine, Robert F. Ballantine, Wm. Clark, Anthony Q. Keasbey, Andrew Lemassena, Jr., and Chas. Bradley, of Newark.

**New York City, N. Y.**—At a recent meeting of the Second Avenue Railroad company, the following named gentlemen were elected as directors for the ensuing year:

George S. Hart, M. M. White, Samuel Knox, Edward C. Smith, Moses Mehrbach, Charles Brenneman, Noah C. Rogers, James L. Breese, Augustus S. Hutchings, Payson Merrill, Charles F. Cox, William E. Peck and Richard A. Anthony.

**Pittsburg, Pa.**—The following named gentlemen have been elected directors of the Monongahela Street Railway company:

R. H. Lee, R. B. Phillips, Jr., John Hennessey, Harry E. Armstrong and Jesse McGeary.

At a recent meeting, the following named gentlemen were elected as directors of the Grant Street Railway company:

Harry E. Armstrong, R. H. Lee, Jesse M. McGeary, R. B. Phillips, Jr., and John Hennessey.

The following named gentlemen have been elected as directors of the Riverside Street Railway company:

H. S. Lydick, R. B. Phillips, Jr., John Hennessey, Harry W. Armstrong and R. E. Lee.

The following named gentlemen have been elected as directors of the recently incorporated Exchange Street Railway:

H. S. Lydick, J. B. Hamilton, John E. Rheam, Wm. Bradley and Newton Petrie.

**Quincy, Mass.**—At a meeting of the recently incorporated Manet Street Railway company, the following named gentlemen were elected as directors:

Messrs. A. D. S. Bell, J. D. Taber, George W. Morton, J. H. Dinegan, A. D. McClellan and George H. Wilson.

**Toledo, Ohio.**—Mr. Charles A. Dennon has been appointed superintendent of the Consolidated Street Railway company, in the place of the late John Gilmartin.

**Woonsocket, R. I.**—At the annual meeting of the stockholders of the Woonsocket Street Railway company, the following named gentlemen were elected as officers and directors for the ensuing year:

President—A. J. Rathbun.  
Secretary and Treasurer—Willard C. Kent.  
Directors—James P. Ray, E. K. Ray, O. J. Rathbun, F. L. O'Reilly, L. B. Pease, L. L. Chilson, F. G. Jillson, Nelson Jenckes and Willard Kent.

STREET RAILWAY NEWS.

FOREIGN

AFRICA—ALGERIA.

**Constantine**—The Decauville company will build a tramway in the province of Constantine. The Decauville system has been adopted.

AUSTRIA.

**Buda-Pesth**—The Budapest Strassenbahn Gesellschaft has been formed, with a capital of 2,500,000 gulden. It proposes to purchase all the existing street railway lines in this city and extend them.

**Gastein**—Messrs. Söenderop & Co., of Berlin, have submitted a project for a tramway line from Lend depot to Bockstein via Gastein. Estimated cost, fl. 1,580,000.

**Vienna**—The Kahlenberg Eisenbahn Gesellschaft have acquired the franchise of the Schottering-Nussdorf Dampftramwaylinis.

The Wiener Tramway Gesellschaft, after a long and exhaustive investigation of the electric system, have concluded to postpone its introduction for the present, the experiments not having proved satisfactory to the company.

BELGIUM.

**Brussels**—The Belgisch-Russische Tram-bahnen-Gessellschaft has been formed, with a capital of 2,500,000 rubles, for the construction and maintenance of tramways of every description in Russia. The larger cities and mineral districts are the objective points of this company.

From the report of the Brusseler Trambahn, for 1889, it appears that the earnings amounted to 2,768,032 francs, being 321,843 francs less than the year before.

The marked difference in the receipts for 1889 and 1890, by which it appears that the latter year showed a deficit of nearly 322,000 francs, compared with the former, has again brought up the question of the electric motor.

ENGLAND.

**Hull**—The Hull Tramway company is seriously considering the introduction of the electric motor.

**Lancaster**—The new Lancaster District Tramway has concluded to adopt the electric system.

**Leicester**—The introduction of electric motors in the tramway line is under favorable consideration.

**Liverpool**—The Liverpool United Tramways have arranged for an experimental demonstration of the workings of the Electric Traction company's accumulator.

**London**—Work on the Southwark Electric Railway is being vigorously pushed forward, and is rapidly nearing completion.

The City of London and Southwark Subway Electric Subway company proposes to alter its name to that of The City and South of London Railway company.

The London Tramways company have introduced a bill for the purpose of applying electricity as a motive power for their various systems of tramways, by means of wire ropes, chains or other electrical apparatus placed underground.

The electric cars of the North Metropolitan Tramway company have proven a great success on the Barking-road section. During the past six months the cars have run 34,366 miles, carrying 469,095 passengers.

The successful working of electric cars on Barking-road justifies the direction of the North Metropolitan Tramway company in hoping that Parliament will sanction the introduction of electric power on the company's system and other lines.

During the latter half of 1889 the London Tramways ran 3,328,000 miles and carried 30,009,000 passengers. Receipts, £145,889; net income, £36,525.

**Newcastle**—The directors of the tramway line have the electric system under consideration.

**Southport**—The electric system is now being agitated by the board of directors of the tramway line.

FRANCE.

**Paris**—A new electric tramway has been completed and offered for public patronage in Clermont Ferrand (Puy de Dome).

The experimental electric tramcars are now running regularly upon the line from the Madeleine to Levallois.

It is understood that the Compagnie des Tramways-Nord intends purchasing a license from the Accumulator company for the application of the Faure-Sellon-Volckmar cells for traction on all its cars.

GERMANY.

**Augsburg**—The annual statement of the Augsburger Trambahn shows that the road was operated in 1888 at a loss of 36,973 marks.

The contract for the construction of the Augsburger Localbahn has been awarded to Gerstenecker, of Munich. Work will be commenced on the enterprise without delay.

**Berlin**—The Grosse Berliner Pferde-Eisenbahn Actien Gesellschaft make a showing of 1,094,096 marks for passenger traffic during December, 1889.

The question of the speedy introduction of electric traction on the Berlin tramways is actively engaging the minds of the engineers and companies in that city.

The January income of the Neue Berliner Pferdebahn Gesellschaft amounts to 123,467 marks.



The earnings of the Neue Berliner Pferdebahn Gesellschaft were placed at 301,779.60 marks for December, 1889.

The Berlin Pferde-Eisenbahn Gesellschaft report 129,273 marks as their earnings for December, 1889.

The Neue Berliner Pferdebahn Gesellschaft place their earnings for 1889 at 1,563,856.36 marks.

The Grosse Berliner Pferde-Eisenbahn has declared a dividend of 12½ per cent. for 1889.

**Bonn**—The projected tramway promises to be a certainty, there being two competitors in the field anxious to procure the contract therefor. Such is the interest in the subject that another company will be formed. As both enterprises are backed by considerable capital, Bonn will be well supplied with first-class tramways.

**Bremen**—The government has granted a franchise for an electric tramway line to be completed and ready for operation at the opening of the Brussels Exposition.

The annual report for 1889 of the Bremerhavener Strassenbahn shows an income of 114,800 marks, derived from 1,032,508 passengers. The Bremerhavener Strassenbahn has declared a dividend of 5 per cent. for 1889.

**Breslau**—The Breslauer Strassen-Eisenbahn Gesellschaft has declared a dividend of 6 per cent. for 1889.

The Breslauer Strassen-Eisenbahn reports its earnings for 1889 at 906,368 m.

**Bruchsal**—A project for the construction of a tramway to connect Bruchsal, Ubstadt, Odenheim, Elsenz and Ubstadt, Unteröwischheim, Gachsheim, has been submitted to the local authorities.

**Burg**—The Wermelskirchen-Burger Smalspurbahn has increased its capital stock to 500,000 marks.

**Charlottenburg**—The Charlottenburger Tramway line is rapidly nearing completion. The company is determined to have its road in working order as soon as possible.

**Cassel**—The Casseler Strassenbahn Gesellschaft report its earnings for December, 1889, as 7,165 marks.

**Dresden**—The Dresdener Strassenbahn have reduced their rates on commutation tickets until further notice. Annual tickets, formerly sold at 150 marks, have been reduced to 120 marks and fractional parts of a year in proportion.

The secretary's report for January of the Dresdener Strassenbahn places its earnings at 128,880 marks, which represents the fares of 144,927 passengers.

The Dresdener Strassenbahn reports 1,881,841.27 marks as the earnings for 1889, representing the fares of 1,216,372 passengers.

**Durlacher**—The Vereinigte Karlsruher-Mühlberger und Durlacher Pferde und Dampfbahn Gesellschaft report their earnings for January at 12,682 marks.

**Elberfeld**—An electric tramway line will shortly be constructed connecting Elberfeld with Barmen on the overhead conductor system.

**Erfurt**—The Erfurter Strassenbahn has declared a dividend of 6 per cent. for 1889.

**Frankfurt**—The Frankfurter Trambahn has declared a dividend of 10 per cent. for 1889.

The Frankfurter Trambahn having found that the Danish horse is superior to the German for street railway service, has decided to exclude the latter in favor of the former on all its lines in future.

**Furth**—The Zindorf Fürth Tramway is rapidly nearing completion, the rails having been laid.

**Gera**—A franchise has been granted Hanoverian capitalists for the construction of a tramway here. The contract has been awarded and work is to begin at once.

**Gotha**—That the street car line will be built is definitely settled. The cost of the project is estimated at 160,000 marks.

**Halle**—The gross earnings of the Hallische Strassenbahn, for 1889, are set down as 179,462 marks.

**Hamburg**—The Grosse Hamburg-Altonaer Strassenbahn Gesellschaft forwarded 3,693,583 passengers over its road in 1889, yielding 393,880 marks.

The capital stock of the Strassen Eisenbahn Gesellschaft has been increased to 6,500,000 marks.

From official statistics it is learned that between July 1, 1888 and June 30, 1889, 47,000,000 passengers passed over the various street railroads of Hamburg.

The Hamburg Strassen Eisenbahn Gesellschaft report 301,780 marks as their earnings for December, 1889.

The official report of the secretary of the Strassen Eisenbahn Gesellschaft, places the earnings for January at 282,647 marks.

The new tramway line from Hamburg to Veddel is now open for business.

The Hamburger Pferdebahn have declared a dividend of 13 per cent. for 1889.

**Karlsruhe**—The Karlsruhe Strassenbahn will establish stations at Durmersheim, Grünwinkel, Forchheim, Mörsch, Blankenloch and Friederichthal.

The passenger traffic of the Karlsruher-Mühlberger und Durlacher Pferde und Dampfbahn Gesellschaft represented 7,165.30 marks for December, 1889.

**Kehl**—The construction of the Kehl-Lichtenau Tramway has been commenced, and will be pushed to completion as rapidly as possible.

**Königsberg**—The Königsberger Pferde-Eisenbahn Gesellschaft has increased its rate of fares.

The income of the Königsberger Pferdebahn Gesellschaft for December, 1889, is placed at 19,618 marks.

**Laupheim**—The concession awarded some years ago to capitalists for the construction of a street car line has been allowed to slumber for some reason. Local enterprising men of wealth becoming disgusted at this state of affairs, held a public meeting and decided to build the road themselves.

**Leipzig**—The December, 1889, report of the Leipziger Pferde-Eisenbahn Gesellschaft shows 137,143.95 marks for passenger travel.

**Ludwigshafen**—Work is being pushed forward vigorously on the Dannstadt-Ludwigshafen Strassenbahn, a number of stations having been erected.

**Magdeburg**—The Magdeburger Strassen Eisenbahn Gesellschaft, during 1889, had 233 employes on their pay roll. Passengers forwarded, 6,960,632; horses, 278; cars, 86.

The Magdeburger Strassen Eisenbahn Gesellschaft has declared a dividend of 10 per cent. for 1889.

The earnings of the Magdeburger Strassen Eisenbahn Gesellschaft for 1889 amounted to 772,433 marks.

**Mannheim**—The earnings of the Trambahn Mannheim-Ludwigshafen for January are reported at 19,916 marks.

**Minden**—The electric system will probably be employed upon the new line to be built this year.

**Munich**—Herr F. Schwarz, proprietor of the Sulzer Bad, has succeeded in procuring a concession for the construction of a cable line to the summit of the Hohenpeifsenberg. Work will be commenced without delay.

The passenger travel on local tramways, which was so seriously affected by the "grippe" epidemic, has resumed its wonted average.

**Nurnberg**—The municipal authorities have passed an ordinance prohibiting vehicles from using the street railway tracks under any consideration whatever, under penalty of a fine of 60 marks or 14 days imprisonment for each and every offense.

**Potsdam**—The December, 1889, showing of the Potsdamer Strassenbahn was 6,654 marks for fares collected.

**Rudeshheim**—The Rüdeshheim-Niederwald Tramway Co. transported 78,533 passengers over its route, a marked increase over last year's record.

**Schleswig**—The contract for the construction of the Schleswig Strassenbahn has been awarded to Herr Kuhrt of Flensburg, work to commence at once.

**Schweinfurt**—A project is on foot to construct a tramway line between Schweinfurt and Gerolzhofen.

**Soden**—The municipal government has granted to Herr Gustav Gallenkamp, of Frankfurt, a franchise for the construction of the Frankfurt-Höchst-Soden Dampf Strassenbahn.

**Spandau**—Work will soon be commenced upon an electric tramway line to connect Spandau with Potsdam.

**Spremburg**—It is reported that the project of a street railway in this city has been revived. Foreign capitalists having withdrawn their support it will become a local affair backed by home capital.

**Spæck**—The tramway line connecting this city with Karlsruhe and Durmersheim has been formally opened for business.

**Stettin**—The Stettiner Strassen Eisenbahn report 30,751 marks as their earnings for December, 1889.

**Strassburg**—The Strassburger Strassenbahn Verwaltung has reduced the rates of fare on its Hagenauerplatz-Schiltigheim-Bischheim-Hönheim Line from 15 to 10 pfennigs.

**Trier**—Mons. de Ferral, of Brussels, was awarded the contract for the construction of the Trier Pferdeisenbahn. Work is to begin at once and pushed forward without delay.

**Wermelskirchen**—The trial trip over the newly built Wermelskirchen Burg Schmalspurbahn was a great success. The road is well appointed in every respect.

**Weisbaden**—The stockholders of the Weisbaden-Strassenbahnen-Actien-Gesellschaft, now in liquidation, have received 30 per cent. as first payment.

#### HOLLAND.

**Amsterdam**—The earnings of the Rotterdamse Tramway Maatschappij for December, 1889, amounted to nied. gulden 30,911.56.

The Omnibus Gesellschaft, proprietor of many of the tramways of this city, has decreased the rate of fare 35 per cent, owing to the opposition of its competitors.

#### ITALY.

**Alessandria**—The Alessandria Tramway owns a well appointed road which is 186 kilogrammes in length, the third longest in Italy.

**Bologna**—The municipal authorities have granted permission to the Bologna-Inola Steam Tramway to increase the number of cars on their trains.

**Cremona**—The Cremona-Ostiana Steam Tramway has been formally opened to the public.

**Flarance**—The Florence Tramway company has declared a dividend of 7 francs per share.

**Genoa**—Four new tramway enterprises are projected in this city, viz: an electric tramway from Piazza Principe to P. Brignole; an electric road between Piazza Corvetto and Stagliano; a cable road from Piazza Zecca to Chiappa Wall, and a cable road from Piazza Acquaverde to the heights of San Ugo.

A French company has received a franchise for a horse car line to traverse the central portion of the city.

**Mantua**—The Mantua Tramway now has 156 kilometers of road in operation.

**Milan**—The Lombardy Horse Racing Society contemplate the building of street car lines to connect the race track of San Siro with the Milan Belt Tramway, the Milan-Magenta Steam Tramway and the Milan North Railroad.

Notwithstanding that Milan is supplied with six tramway lines, viz: to Lodi, Pavia, Tradate, Magneta, Giussana and Vaprio, it is reported that there is another line in contemplation.

**Monza**—The Monza-Trezzo-Bergam Steam Railway has been completed and formally opened for public patronage.

**Naples**—The projected Naples-Averta-Piedimonte d'Alife Tramway has at last assumed a definite shape. Work will be commenced without delay, and the road will be pushed forward to speedy completion.

**Rome**—The Roman Tramways Society has concluded a contract with the Series Electrical Traction Syndicate to make experiments upon the line on the Via Flaminia, outside the Porta del Popolo.

**Udine**—The Udine-San Daniele Tramway has been opened for public patronage. This road will probably be extended to Spilimbergo.

#### RUSSIA.

**Moscow**—The construction of street railways in different parts of Russia is being considered by Russian capitalists, who are jealous of the encroachment of the Russia-Belgium Tramway Co., an incorporation devoted to that branch of enterprise.

The annual statement for 1889 of the Tramways de Moscow et de Russie make a showing of 1,270,507 francs earned.



**St. Petersburg**—The Russisch-Belgische Trambahn Gesellschaft, with a capital of 2,500,000 rubles, organized for the purpose of building tramways in Russia, has been formally acknowledged by the Russian government.

At the urgent request of patrons in the suburbs, the St. Petersburg and Nawaja Derewnja Tramway Line will run all-night cars. An increased rate of fare will be charged.

**SWITZERLAND.**

**Birsigthal**—The passenger traffic of the Birsigthal Bahn makes a showing of fs. 9,051.10 for December, 1889.

**Brienz**—A franchise has been granted by the government for the construction of a cable road from Brienz to Rothhorn (Canton Bern). The estimated cost will be about 2,000,000 francs.

**Rheinock**—The government has granted a concession for a cable road from Rheinock to Walzenhausen. The estimated cost will be 500,000 francs.

**Rorschach**—Herr A. Klose had made application for a concession for the Rorschach-Bruggen Tramway line, which is to pass through St. Gallen, St. Fiden and Waid. If the request should be granted, the line is to be extended so as to pass through the villages of St. Fiden, Neudorf, Speicher and Trogen.

**Zurich**—The Züricher Strassenbahn report fs 23,505.90 as the net earnings for December, 1889.

**SOUTH AMERICA—BRAZIL.**

**Rio de Janeiro**—The local tramway systems employ 5,867 mules and 459 cars, and traverse 250 kilometres of road. Their combined income in 1888 amounted to 6,192,358 milreis.

**TURKEY.**

**Salonichi**—Hamdi Bey has disposed of his concession for the construction of a local tramway to an English company.

**Patents.**

The following is a complete list of such patents as relate to street railway interests, issued during the past month, and especially prepared for the STREET RAILWAY GAZETTE by Messrs. Higdon & Higdon, Solicitors of U. S. Patents and Trade Marks, Room 7, St. Cloud Bldg., opposite U. S. Patent Office, Washington, D. C. A printed copy of any patent here named will be furnished by them for 25 cents (stamps).

*Issue of January 7, 1890.*

- 418,678. Electric Switch for Motors, Detroit Motor Co., Detroit, Mich.
- 418,685. Brush-Holder for Dynamos, P. Claus & E. Gengenbach, New York, N.Y.
- 418,911. Electric Heating Apparatus for Electric Railway Systems, Dewey Corporation, Syracuse, N.Y.
- 418,912. Transforming and Utilizing Electrical Energy, M. W. Dewey, Syracuse, New York.
- 418,893. Electrically Propelled Vehicle, R. M. Hunter, Philadelphia, Pa.
- 418,843. Means for Electrical Propulsion of Vehicles, D. E. Johnson, Atlanta, Ga.
- 419,052. Automatic Switch for Street Railways, H. W. Libbey, Boston, Mass.
- 419,059. Electric Motor, H. B. Niles, Union Springs, N.Y.
- 418,850. Cable Railway Signal, Rapid Transit Cable Co., New York, N.Y.
- 418,853. Electric Motor or Generator, I. E. Storey, Boulder, Colo.

*Issue of January 14, 1890.*

- 419,308. Conduit for Electric Railways, B. J. Black, Richmond, Va.
- 419,309. Electric Street Railway, B. J. Black and W. F. Jenkins, Richmond, Va.
- 419,245. Electric Motor, United Electric Improvement Co., Gloucester, N. J.
- 419,602. Street-Car and other Advertising Device, B. Dubinski, St. Louis, Mo.
- 419,450. Elevated Single Railway, J. C. Jefferson, and J. T. Pullon, Leeds, England.
- 419,588. Safety Device for Elevators, C. Klinik, Königshutte, Prussia, Germany.
- 419,534. Street Car Motor, B. R. Moore, Kansas City, Kan.
- 419,594. Elevated Railway, W. M. Morgan, Kansas City, Mo.

*Issue of January 21, 1890.*

- 419,618. Electric Railway System, T. E. Adams, Cleveland, O.

- 419,629. Transfer-Carriage for Elevated Ways, W. S. Bogle, Chicago, Ill.
- 419,923. Electrical Conductor, H. H. Carpenter, New York, N.Y.
- 419,753. Electric Locomotive, W. H. Darling, New York, N.Y.
- 419,841. Electric Railway, Dewey Corporation, Syracuse, N.Y.
- 419,660. Electric Commutator, L. Gutmann, Fort Wayne, Ind.
- 419,661. Dynamo or Motor, L. Gutmann, Fort Wayne, Ind.
- 419,662. Electric Commutator, L. Gutmann, Fort Wayne, Ind.
- 419,664. Alternating Current Motor Regulator, L. Gutmann, Fort Wayne, Ind.
- 419,771. Overhead Contact and Switch, R. W. Hawkesworth, East Grange, N. J.
- 419,992. Cable Street Railway, L. Heynemann, San Francisco, Cal.
- 419,673. Electrical Railway System, Electrical Invention Co., of Chicago.
- 419,677. Protecting Plate for Grip Cars, H. E. Hunt, Pittsburg, Pa.
- 419,709. Electric Railway System, C. Richter, Camden, N. J.
- 419,739. Single-Rail Elevated Railway, J. N. Valley, Jersey City, N. J.
- 419,808. Electric Motor, LeRoy S. White, Waterbury, Conn.

*Issue of January 28, 1890.*

- 420,265. Fare Box, J. Bricker, Philadelphia, Pa.
- 420,154. Aerial Railway, H. N. B. Giuseppi, Luri, Corsica, France.
- 420,065. Hose Bridge, A. H. Hatchard, Lynn, Mass.
- 420,233. Automatic Cover for Cable Railway Slots, G. W. Higgins, Bunker Hill, Kan.
- 420,101. Conduit for Electric Street-Railways, J. W. Reno, Boston, Mass.
- 420,117. Electric Motor and Regulator therefor, E. A. Sperry, Chicago, Ill.
- 420,398. Governor for Dynamos or Motors, Schuyler Electric Light Co., of Conn.
- 420,138. Regulator for Dynamos, J. J. Wood, Buffalo, N.Y.

*Issue of February 4, 1890.*

- 420,8c4. Conduit for Electric Railways, D. E. Johnson, Atlanta, Ga.
- 420,693. Electro-Magnetic Car Brake, D. S. McElroy, New York, N. Y.
- 420,543. Electric Street Car Gear, E. Peckham, New York, N. Y.
- 420,544. Electric Car Gear, E. Peckham, New York, N. Y.
- 420,545. Electric Car Axle, E. Peckham, New York, N. Y.
- 420,469. Regulation of Electric Motors, L. W. Serrell, Plainfield, N. J., and H. L. Lufkin, New York, N. Y.
- 420,550. Mechanism for Depressing Cables at Crossings of Cable Railways, F. G. Stallman, San Francisco, Cal.

*Issue of February 11, 1890.*

- 421,222. Commutator for Dynamos, Motors, etc., Thomson-Houston Electric Co., of Conn.
- 421,125. Cable Grip, E. Dainty, Coal Bluff, Pa.
- 421,048. Regulator for Dynamos, J. E. Maynardier, Taunton, Mass.
- 421,050. Cable Grip, N. Kirchner, Philadelphia, Pa.
- 421,304. Trolley for Electric Railways, Detroit Electrical Work, Detroit, Mich.
- 421,305. Overhead Trolley for Electric Railways, Detroit Electrical Works, Detroit, Mich.
- 421,230. Collecting-Contact for Electric Machines, Westinghouse Electric Co., Pittsburg, Pa.

*Issue of February 18, 1890.*

- 421,538. Cable Railway Grip Attachment, J. F. Appleby, Minneapolis, Minn.
- 421,476. Driving Mechanism for Motor Cars, J. C. Beckfeld, and A. Schmid, Allegheny, Pa.
- 421,479. Dynamo Electric Machine, D. B. Brace, Lincoln, Nebr.
- 421,813. Portable Railway, A. Bryson, and C. Tiers, New York, N. Y.
- 421,677. Support for Trolley Wires, J. H. Cunningham, Chelsea, Mass.

- 421,820. Rail for Elevated Ways, J. W. Davy, Pittsburg, Pa.
- 421,829. Locomotive Street Car, J. R. Gathright, Louisville, Ky.
- 421,398. Conduit for Electric Railways, P. H. Griffin, Buffalo, N. Y.
- 421,494. Cable Railway Mechanism, J. Hartman, Jr., Philadelphia, Pa.
- 421,840. Traction Mechanism for Railways, E. Samuel, Philadelphia, Pa.
- 421,870. Coupling for Street Cars, E. B. Sanborn, Oshkosh, Wis.
- 421,628. Cable Car, J. Stephenson, New York, N. Y.
- 421,629. Grip-Carrier, J. Stephenson, New York, N. Y.
- 421,790. Electric Motor, C. M. Rhodes, Philadelphia, Pa.
- 421,535. Switch for Systems of Electric Locomotion, F. Wheeler, Meriden, Conn.
- 421,464. Electric Railway Car, H. C. Wirt, Boston, Mass.

*Issue of February 25, 1890.*

- 421,887. Electrically Propelled Vehicle, J. Adair, New York, N. Y.
- 421,894. Tramway Locomotive, R. S. Battles, Girard, Pa.
- 422,069. Street Car Gearing, J. Carnes, Lima, O.
- 421,911. Regulating Apparatus for Electric Motors, P. Diehl, Elizabeth, N. J.
- 422,339. Electric Motor Car, U. H. Farnham, Malden, Mass.
- 422,352. Transfer Apparatus for Traction Cable Cars.
- 422,148. Dynamo-Electric Machine or Motor, Florence Motor Co., of Maine.
- 422,149. Electric Motor, Florence Motor Co., of Maine.
- 421,967. Dynamo-Electric Machine, Electrical Accumulator Co., of New York.
- 422,096. Device for Suspending Electric Conductors at Crossings, S. H. Short, Cleveland, Ohio.
- 422,266. Electric Railway Motor Car, C. J. Van Depoele, Lynn, Mass.

*Issue of March 4, 1890.*

- 422,693. Brake Mechanism for Street Cars, W. E. Badger, Quincy, Mass.
- 422,511. Dynamo-Electric Machine, R. Eickemeyer, Yonkers, N. Y.
- 422,755. Electric Motor Engine, S. Z. Ferranti, Hampstead, England.
- 422,888. Car Starter, L. P. Wilcox, Chicago, Ill.
- 422,445. Supporting Frame for Electric Railway Motors, E. D. Priest, Lynn, Mass.
- 422,645. Electric Railway, S. H. Short, Cleveland, O.
- 422,466. Pleasure Railway, L. A. Thompson, Philadelphia, Pa.

*Issue of March 11, 1890.*

- 423,309. Holder for Commutator Brushes, J. C. Chamberlain, New York, N. Y.
- 423,130. Pneumatic Railway, M. A. Clennam, San Francisco, Cal.
- 423,029. Regulation of Alternate Current Generators, United Electric Improvement Co., Gloucester City, N. J.
- 423,225. Car Brake and Starter, E. Dredge, Stoke Newington, England.
- 422,923. Slot Brake, A. Du Bois, Cincinnati, O.
- 423,072. Rail Chair for Street Railways, A. J. Moxham, Johnstown, Pa.
- 423,081. Cable Railway Crossing, Johnson Co., Kentucky.
- 423,391. Trolley for Overhead Electric Railways, F. B. Rae, Detroit, Mich.
- 423,392. Car-Gong, F. B. Rae, Detroit, Mich.
- 422,975. Coupling Electric Motors, E. W. Rice, Lynn, Mass.
- 423,004. Overhead Electric System, W. Vogler, Somerville, Mass.
- 423,396. Street Car, C. L. Snyder, Kansas City, Mo.

*Issue of March 18, 1890.*

- 423,470. Street Car Running Gear, A. V. Du Pont, Louisville, Ky.
- 424,552. Electric Railway System, L. Gutmann, Fort Wayne, Ind.
- 423,533. Alternating Current Electric Regulator, L. Gutmann, Fort Wayne, Ind.
- 423,555. Brake-Operating Mechanism for Motors, J. Hahn, New York, N. Y.



Electric Street Railways in North America.

IN OPERATION OR UNDER CONTRACT MAY 1, 1890.

Table listing electric street railways in North America, including columns for Operating Co., Location, System, Cars, and Miles. Entries range from Adrian Electric Ry. to Pennsylvania Motor Co.

Table listing street railway securities, including columns for Operating Co., Location, System, Cars, and Miles. Entries range from Peoples RR. Co. to Youngstown St. Ry. Co.

Street Railway Securities.

NEW YORK AND BROOKLYN.

Table detailing street railway securities for New York and Brooklyn, including columns for Name of Company, Par value, Capital, Period, Rate, Last Div., Bid, and Asked. Entries include Atlantic Avenue Railroad, Broadway & Seventh Avenue, etc.



# The Street Railway Gazette.

(Copyrighted, 1890.)

Vol. V.

CHICAGO.

JUNE, 1890.

CHICAGO.

No. 6

## ELECTRIC RAILWAYS.

### New Motor-Dynamo.\*

This new motor dynamo possesses features of considerable interest, not altogether because their application is new, but more particularly on account of their demonstrations of the gain to be made by the application of purely mechanical principles to the construction of electrical machinery. The motor shown in the accompanying illustration is of the short magnet consequent pole type of field enclosing a drum armature. The magnet cores are of the best Norway iron, the yokes and pole pieces being of soft cast iron of the best quality for the purpose. The cores extend entirely through the yokes and pole piece, giving the greatest possible amount of surface contact between the two metals, thus reducing the magnetic resistance. But the extent of surface alone is not depended on wholly to reduce the resistance. As will be noticed in the illustration, the yokes and pole pieces after being bored to fit are split and provided with bolts by which they are clamped solidly to the cores. This is done more to still further reduce the magnetic resistance, than for any convenience of mechanical construction. The benefit derived from this method is clearly shown by the small amount of wire required on the magnets, for the resistance is so greatly reduced that no consequent poles can be detected at the joints. In the usual way of building dynamos and motors where the cores and yokes are brought together on planed surfaces only, the resistance is so great that consequent poles of considerable strength are formed, as can easily be shown by a pocket compass or small piece of magnetized steel. These consequent poles at joints entail a loss that is entirely absent in the Bain motor dynamo. The name of motor dynamo is given to this machine, not because there are two machines in one, but on account of the adaptability of a single machine to either purpose. It is usually said that a motor is but a dynamo run backward, though there are but few if any machines that can be practically operated in both ways. The machine from which the illustration was taken has a capacity of  $7\frac{1}{2}$  h. p., and is now being operated as a motor running an elevator and paper cutting machine in the Chicago Paper Company's warehouse, and shows an efficiency of  $95\frac{1}{4}$  per cent. In operation under full loads the motor shows no signs of heating in any of its parts, the bearings being provided with self-oiling apparatus and the wire having sufficient current capacity to prevent heating under any con-

dition of load. Foucault currents are reduced to a minimum so that heating, from that cause is not noticeable. This machine is built in sizes of 5 to 100 h. p., wound for circuits of any potential or current now in use, the larger ones being compounded in a peculiar manner, a late invention of his which insures an absolutely steady speed under all changes of load. The machines will show an equal efficiency when used as either dynamo or motor. As a motor the machine runs very quietly with but slight variation in speed under full changes of load.

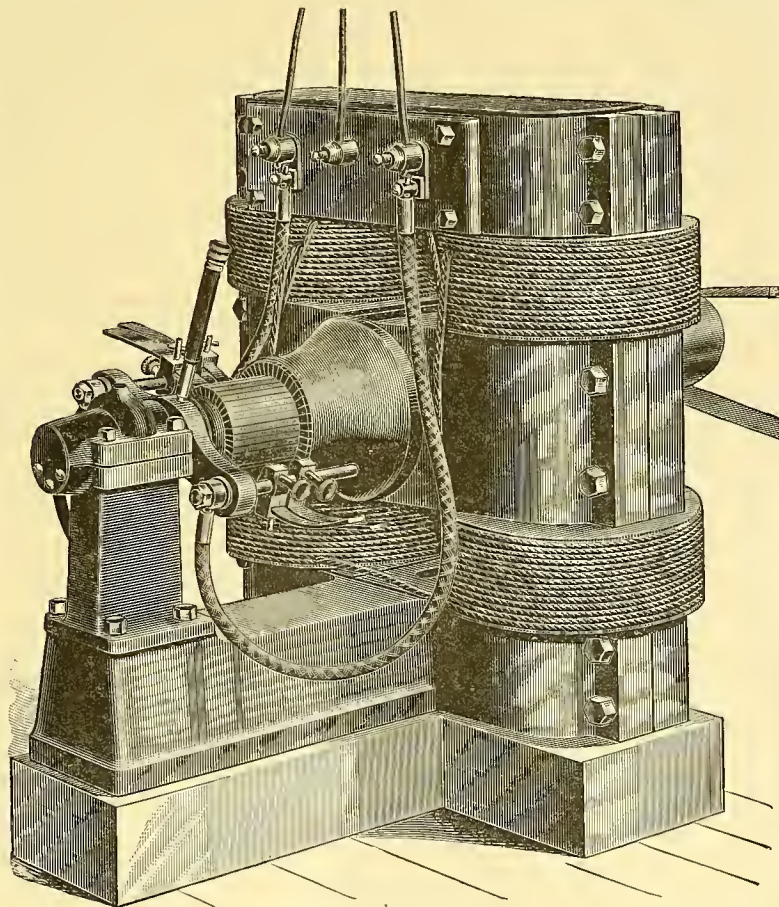

NEW MOTOR-DYNAMO.

### American Institute of Electrical Engineers Annual Meeting.

The annual meeting of the American Institute of Electrical Engineers was held in New York on May 20, and after the business of the Institute had been transacted, a large number of the members went on to Boston for the regular general meeting. Among the papers read, of deep interest to street railway men, was one by Mr. H. F. Parshall, entitled "Magnetic Data of the Sprague Street Car Motor," and one by Mr. O. T. Crosby on "The Limitations of Steam and Electric Transportation," of which the following is a transcript:—

### THE LIMITATIONS OF STEAM AND ELECTRICITY IN TRANSPORTATION.

BY O. T. CROSBY.

"Do you expect electric engines entirely to displace steam locomotives on all railroads?" That is a question which has doubtless been propounded to many electrical engineers. Its answer has probably been made, in general, by wise reference to the boundless possibilities of direct production of electrical energy from heat, and to Bellamy's "Looking Backward" storage batteries.

To make some study of the boundary line dividing the province of steam locomotion from that of electric locomotion—under existing conditions of producing electric energy—is the object of this paper.

In the light of present achievements I may state, without argument, the following propositions:

First—It is possible to construct motors capable of doing the maximum work required to-day in transportation.

Second—It is possible continuously to generate electric energy equal to the capacity of any number of such motors.

Third—At any desired loss and over any desired distance it is possible to supply, by the running contact method, the necessary current, at considerable pressure, for the working of such motors.

Should there still be question in the minds of any as to the value of the running contact method at speeds much higher than those commonly used, I may state that I have seen 75 amperes at 500 volts thus continuously supplied to a car moving at more than 110 miles per hour.

These premises being established, further discussion divides itself into three parts.

First, the mere possibility, without reference to economy, of steam and electric propulsion under given conditions.

Second, as to the relative cost of exerting, in a locomotive, any unit of power by electric, as compared with direct steam motors.

Third, as to the relative amount of power required by the two agents to transport a given paying load under given conditions.

In using the word steam, as above, I have in mind only the direct application of steam power on the tracks. The case of cable propulsion is not here compared, as that has, within its restricted field of application, already been compared with horse, steam and electric power.

The limiting possibilities of locomotion may be understood by considering a prolongation of the lines of present practice in the direction, first, of loads handled; second, grades climbed; third, speeds attained; fourth, length of continuous runs.

Since the effect of grade, as compared with line, is simply to increase the tractive effort required for a given load and speed, it need not be separately treated except that there has been some question of increase of adhesion, in the ground return method, which in extreme cases might appear as an advantage for electric propulsion. The matter is not of great importance, and I will refer to it only so far as to say that interpreting my own general experience and some special tests, the adhesion coefficient seems not increased in any practical degree by the mere passage of the current from wheel to rail.

The capacity of an electric engine, like that of a steam engine, to haul any given load, will be measured by the tractive effort possible to be produced and the relation between weight and adhesion for given track conditions. The ready multiplication of cylinders in the one case and armatures in the other, while maintaining mechanical unity as to drawbar division and the ready coupling of distinct locomotive units, renders the whole question of capacity to exert a given horizontal effort, without regard to the time element, unimportant and indefinite. It goes without saying that, if desired, a single armature may be constructed

\* Force Bain, Chicago.



capable of exerting as great a drawbar strain as any locomotive now in use.

As to limiting speeds it is not easy to-day to make "an educated guess" either for steam or electric propulsion. The high figures for steam that have been recently presented, both from England and America, are higher than the limiting figures as they would have been given by many competent authorities only a few years ago.

Would it be possible to attain a speed twice as great, or say 150 miles per hour?

A driver 2 1/2 feet in circumference would require to revolve 550 times per minute in order to travel 13,200 feet per minute, or 150 miles per hour—this without slip.

values, I have been able to separate more nearly than has heretofore been possible the atmospheric from all other resistances met at high velocities. Some inaccuracy still remains, by reason of the difficulty of obtaining exact measure of the resisting areas in a train, but I have been able, by study of careful tests made by others on the New York Central and on English roads, to find that over the range from about 40 up to 80 miles per hour the tonnage coefficient seems practically constant at 8 pounds.

Having made this necessary digression, we may return to the matter of steam supply, and state that by reducing weight and area, both to something less than one half the original values in the 86 mile run, the same effort would produce the speed 150, instead of 86.

per h. p. hour on a steam locomotive. The coal figure is very close to actual practice. The water figure is less, but makes allowance for scooping water at convenient intervals. Continuous scooping is not considered practical or economical.

TABLE I. Columns 1 to 20 inclusive.

Table with columns: Speed, Tonnage, Areas exposed per ton in sq. ft. (1.0, 0.75, 0.5, 0.25, 0.2, 0.1), Rate of work in H. P., 10 per cent. loss (2 and 3, 2 and 4, 2 and 5, 2 and 6, 2 and 7, 2 and 8), H. P. at 20 per cent. loss (2 and 3, 2 and 5, 2 and 8), H. P. at 40 per cent. loss (2 and 3, 2 and 5, 2 and 8).

Columns 21 to 41 inclusive.

Table with columns: Speed, Tonnage, Coal and water for one hour, 5 lbs. coal, 15 " water, Locomotive and tender at 100 lbs. per H. P., Weight machinery and fuel and weight of load, steam 10 per cent. loss, Weight load and weight machinery, electric, 10 per cent. loss, Weight load and weight machinery, electric, 20 per cent. loss, Weight load and weight machinery, electric, 40 per cent. loss.

Columns 42 to 62 inclusive.

Table with columns: Speed, Tonnage, Power for one ton freight and car, steam, 10 per cent., Power for one ton freight and car, electric, 10 per cent., Power for one ton, electric, at 20 per cent., Power for one ton, electric, 40 per cent. loss, Ratio = Steam 10 per cent. Elec. 10 per cent., Steam 10 per cent. Elec. 20 per cent., Steam 10 per cent. Elec. 40 per cent.

have been reached, the drivers being smaller, and since on stationary engines a speed much above 550 revolutions per minute has been attained, it seems beyond question that from this point of view the supposed case is quite possible.

Considering the matter of steam supply we are again brought to consider the whole matter of train resistances at all speeds.

Total resistance to motion should be sharply divided into two classes: the resistance due to motion through air, and that due to friction and blows between the vehicle and track and to friction and blows between parts of the vehicle.

For the most part those who constructed the formulæ now found in the text books, worked on roadbeds far inferior to the best work of to-day, at speeds much less than those now attained and with wrong values for at least one of the species of resistance, the atmospheric. On this point I have recently been able to present as the results of experiments at high velocities, made by Mr. Benj. J. Dashiell, Jr., and myself, a formula showing the pressure to be a function of the first instead of the second power of the velocity as ordinary assumed.

The absolute values given, while corresponding quite closely with those of received formulæ in the neighborhood of the velocities heretofore experimentally attained, depart widely from those assumed for velocities higher than 30 miles per hour, and calculated by the quadratic relation between velocity and pressure. Using the more trustworthy

weight—say to 100 tons, or to little more than engine and tender—maintenance of the higher speed becomes possible, with nearly the same steam expenditure as in the recorded case.

To attain that speed, from rest, might require such original weight of fuel and such length of favorable track as to make the feat practically impossible with steam. This leads us to inquire into the dead weight necessary for hauling say one ton at different speeds.

Form the table of horse power required for exerting the tractive effort for one ton at various speeds, at various efficiencies, with various values of cross-section per ton, and with the two agents—steam and electricity:

Column 1 shows speed in miles per hour from 20 to 140. Column 2 corresponding tonnage coefficient, or resistance, in pounds per ton inclusive of atmospheric resistance. Columns 3 to 8 inclusive show horizontal effort needed for overcoming atmospheric resistance under various assumptions as to area exposed per ton, from 1 square foot to 0.1 square foot per ton.

weights from 2,000 pounds. Columns 33 to 41 show corresponding figures for electric locomotives under the assumption of 60 pounds per h. p., and at the three efficiencies, 90, 80 and 60 per cent.

The 60 pounds per horse power covers weight of containing car for motors. I can not here go into detailed figures on this point, but believe that any investigation will find the figure safe, supposing always that the unit be, say, 25 h. p. or more. I also know of experimental work now progressing under most competent direction, which gives fair promise of leaving this figure much too high.

It is plain that if we can now obtain the ratio of cost per horse power hour, as given by the two agents, in the corresponding cases, we can easily determine the speeds at which the one or the other agent becomes the most economical.

Let us first obtain the cost in electric propulsion. For this, form table II., showing the elements in the cost of one horse-power hour in stations of various capacities—



from 100 to 3,000 h. p. Engineers and dynamo-men are assumed to receive 40 cents per hour, and to superintend a maximum of 1,000 h. p. This would produce in some cases, fractional engineers, as for a 1,500 h. p. plant, but such complication has been avoided by assuming a constant value per unit of power, in the pay-roll element in plants exceeding 1,000 h. p. Firemen and helpers are taken at 30 and 25 cents per hour, respectively. Superintendence, at 30 cents per hour, is apparently low, but is equivalent to 60 cents for daylight hours since the plant is able to run 24 hours with the same general superintendence as for 12 hours. It is further supposed that the total of this item will not require increase until the capacity reaches 3,000 h. p., beyond which it remains constant per unit of power. As no other element of cost is supposed to vary beyond this point, the table shows here a minimum total cost per unit, and a constant cost beyond it.

the tabulated values have been determined from the resulting formula,

$$\text{Cost} = \frac{760,320}{(E-V)V} \quad (1)$$

in which  $E = E. M. F.$  at station,  $V =$  volts lost on line, motor efficiency is taken at 90 per cent, and distance at 5,280 feet. The tabular figures give the investment. To reduce to actual cost per horse power hour, rate of interest and depreciation, and ratio between power transmitted, and power possible to be transmitted. For one year the possible horse power hours =  $365 \times 24$ . Take annual interest and depreciation at  $\frac{5}{100}$  the investment and ratio of actual to possible power transmitted per annum at 1.0, 0.8, 0.6, 0.4, 0.2, 0.1, 0.05, then the divisor of the tabular number becomes 140,160, 112,128, 84,096, 56,064, 28,032, 14,016 and 7,008 respectively.

respect to  $n$ , equal to zero, and solving to find the value of  $n$ , giving a minimum value for  $C$ . If trains be run at very short intervals, increase of  $n$  would be followed by proportional increase in capacity of station; but as above shown, this need not go beyond 3,000 h. p. unless the service be so heavy as to require practically contiguous stations of that capacity. If we suppose a case of this short-interval service, so short, that a change in  $n$  will not be followed by any change at the station in the relation between maximum capacity and average output, or in the number of working hours, but only in the normal capacity, the relation between  $b$  and  $n$  for two cases of average output and working hours is readily ascertained. The equation of the 50 per cent. curve from 200 to 1,000 h. p. seems to be very nearly

$$b = n^2 \frac{-98n + 1,000}{12(n-100)}$$

If the trains be run at very long intervals, we may require no greater station capacity for 20 than for 10 mile sections; but the relation of output to normal capacity will vary, and possibly the number of hours during which the working force would require to be kept on pay.

Taking the case of a change in average output only, for a 1,000 h. p. station, we have the curves in Plate 2, for 24, 18 and 12 hours' work. Their equations are nearly of the same form, and are approximately the equations of arcs of circles referred to an origin outside the circle. But each would contain different constants, and would vary more or less from the exact formula for the circle.

If, in the application to a particular case, the algebraic expression for  $b$  above given, or any other resulting from any of the possible progressions through Table III, be substituted in equation 2, we may, by differentiation, solve that particular case for the most economical value of  $n$ . If the relation between  $b$  and  $n$  cannot be algebraically expressed, then the proper value for  $n$  may be determined by a few trial values, the corresponding values of  $b$  being taken from the table.

For the present purposes of comparison we shall assume a case not more favorable than might often be met on busy steam lines, *i. e.*, a station of 2,000 h. p. normal capacity, working 18 hours per day at 40 per cent. of its normal output, the cost per horse power being 1.25 cents.

To obtain the cost of the line, we shall assume that the average distance of transmission is five miles. This would correspond to one station for every twenty miles of road. We shall also assume 5,000 volts initial E. M. F. and 10 per cent. drop. From Table IV, the copper investment is found to be 34 cents for one mile. Then for five miles investment equals \$8.50. Making assumptions as to service corresponding to those for the stations, we have cost of one horse power hour equaling \$8.50 ÷ 20,000 = 0.425 cents.

The structure for carrying the conductors may be built for \$2,000 per mile. Interest and depreciation would then become \$200 per annum. This total is almost wholly independent of the power transmitted, hence the cost per unit of power will vary directly with the number of units transmitted. Assuming a constant distribution of one 500 h. p. train for every 20 miles of line, we have cost of this item for one horse power hour :

$$20,000 \div 365 \times 24 \times 25 = 0.09 \text{ cents.}$$

Reaching the locomotive, we must add, supposing an average output of 500 h. p., 0.08 and 0.06 cents respectively for driver and his assistant. The latter is necessary only as a substitute for his principal in case of emergency, but as such he would doubtless always be placed on trains of considerable value.

Repair on electric locomotives is not as yet well defined. That the repair bill must be far less than in the case of steam locomotives follows almost necessarily from the great reduction in the number of parts, especially of moving parts.

From Mr. Arthur Wellington's very valuable work on railways, I take the figures showing percentage distribution of locomotive repairs, by parts.

Boiler, 20 per cent.; running gear, 20 per cent.; machinery, 30 per cent.; lagging and painting, 12 per cent.;

TABLE II. ELEMENTS OF THE COST OF ONE H. P. HOUR, ELECTRIC.

Capacity	100	300	500	800	1,000	1,500	2,000	3,000	4,000	5,000	6,000
Engineer	0.4	0.13	0.08	0.05	0.04	0.04	0.04	0.04	0.04	0.04	0.04
Fireman	0.3	0.10	0.06	0.037	0.03	0.03	0.03	0.03	0.03	0.03	0.03
Dynamo man	0.4	0.13	0.08	0.05	0.04	0.04	0.04	0.04	0.04	0.04	0.04
Helper	0.25	0.08	0.05	0.031	0.025	0.025	0.025	0.025	0.025	0.025	0.025
Superintendence	0.30	0.10	0.06	0.037	0.03	0.03	0.03	0.03	0.03	0.03	0.03
Coal	0.475	0.157	0.10	0.075	0.06	0.06	0.06	0.06	0.06	0.06	0.06
Oil, waste and water	0.15	0.15	0.15	0.15	0.15	0.15	0.15	0.15	0.15	0.15	0.15
Interest and depreciation of steam plant	0.057	0.051	0.044	0.039	0.032	0.022	0.022	0.022	0.022	0.022	0.022
Ditto electric plant	0.057	0.051	0.044	0.039	0.032	0.022	0.022	0.022	0.022	0.022	0.022
Ditto Building	0.028	0.026	0.022	0.168	0.014	0.011	0.011	0.011	0.011	0.011	0.011

Coal is assumed to cost \$3.00 per ton and to be consumed at the rate of 3.2 pounds per electric h. p. in the dynamo. A very slight error is made in taking the rate of consumption as constant while changing the capacity of the engines.

Cost of steam plant is taken to vary from \$50 per h. p., in a small plant, to \$20 in a plant of 1,500 h. p. This latter figure may seem too low to some, but I have recently seen the figures for an 800 h. p. plant, in a neighboring Massachusetts city, which cost, in place, at the rate of \$22 per h. p.

Dynamo plant is taken to vary from \$50 to \$20 per h. p. in going from 100 to 1,500 h. p. I know that machinery of good design can be manufactured for these prices.

The cost of buildings is taken to vary from \$25 to \$10 per h. p. This is the most indefinite item. Interest, maintenance and taxes, are roundly assumed at 10 per cent per annum on the whole plant.

With table II, as a basis, table III, has been calculated, giving total cost per horse power hour in stations of various capacity, working at various percentages of full capacity and for 24, 18 and 12 hours per day, respectively.

TABLE III. TOTAL COST OF ONE H. P. HOUR.

Output in per cent. of capacity while working.	Hours of work per day	CAPACITY OF STATION.							
		100	300	500	800	1000	1500	2000	3000
		100	2.42	1.29	1.06	0.9148	0.860	0.835	0.825
80	2.52	1.56	1.115	0.938	0.888	0.855	0.849	0.839	
60	2.85	1.52	1.228	1.028	0.955	0.95	0.895	0.867	
40	3.62	1.36	1.12	0.947	0.88	0.86	0.85	0.83	
20	2.77	1.45	1.17	0.98	0.91	0.88	0.87	0.853	
12	3.10	1.61	1.29	1.06	0.99	0.94	0.925	0.81	
80	2.87	1.45	1.18	0.987	0.92	0.91	0.88	0.86	
60	3.06	1.55	1.23	1.03	0.98	0.936	0.926	0.90	
40	3.42	1.73	1.37	1.13	1.06	1.030	0.98	0.95	
20	3.19	1.57	1.26	1.04	0.96	0.925	0.91	0.89	
18	3.42	1.68	1.32	1.09	1.01	0.952	0.94	0.91	
12	3.82	1.90	1.48	1.19	1.09	1.02	1.01	0.97	
60	3.62	1.73	1.36	1.11	1.01	0.975	0.96	0.94	
40	3.85	1.85	1.44	1.16	1.06	1.015	1.00	0.96	
20	4.31	2.11	1.63	1.30	1.17	1.085	1.09	1.01	
50	4.22	1.95	1.52	1.20	1.10	1.045	1.03	1.00	
18	4.50	2.10	1.61	1.27	1.15	1.09	1.076	1.03	
12	5.09	2.40	1.83	1.43	1.28	1.19	1.17	1.11	
24	5.11	2.28	1.73	1.35	1.21	1.15	1.13	1.10	
18	5.47	2.48	1.88	1.44	1.33	1.25	1.23	1.17	
12	5.20	2.82	2.17	1.64	1.50	1.38	1.35	1.28	
30	6.63	3.84	2.10	1.59	1.40	1.295	1.30	1.26	
18	7.08	3.02	2.27	1.71	1.50	1.40	1.38	1.32	
12	8.06	3.53	2.65	1.98	1.73	1.57	1.54	1.44	

A glance at the table shows that in a 100 h. p. plant the cost varies from 2.42 cents for a 24 hour run at full capacity, to 8.06 cents for a 30 per cent. output continued only 12 hours per day.

This extreme case would doubtless be ameliorated by dropping the superintendence and combining engineer and fireman—though to this the unions might object. This capacity is smaller than need be considered for any steam-line service.

The minimum cost given by the table is 0.816 cents, this for a 300-h. p. plant, working full capacity 24 hours per day.

The next element of cost—that of the conductors for the current—is obtained from table IV., showing investment in dollars for the copper required to transmit one h. p. a distance of one mile, at varying initial and final pressures. The constants for this table were thus obtained; taking a well known line wire, I find that from No. 4 to No. 000 B. W. G., the average weight-ratio of insulated to bare wire, per unit of length, equals 0.884. When bare copper sells at 15 cents, this insulated wire sells at 20 cents = 22.5 cents on the copper alone, when insulated. If, therefore, we take copper at 25 cents per pound we provide for a very good insulation. The cost of one mil mile is thus found to be \$0.04. Combining this with the familiar formula

$$CM = \frac{16,600 \times \text{h. p. transmitted} \times \text{distance in feet.}}{E. M. F. \text{ at motor} \times \text{volts lost on line} \times \text{motor efficiency,}}$$

It remains to obtain values for the distance of transmission.

Let  $n =$  number of miles of line supplied from one station.

$h =$  horse power required for unit locomotive.

$K =$  maximum number locomotives per mile at any time.

$n h K =$  total power to be transmitted at time of  $K$ .

$A =$  percentage of dynamo power lost on line.

$\frac{n h K}{100-A} =$  maximum power to be generated.

$$\frac{n h K A}{100-A} = \text{ " " lost on line.}$$

$b =$  cost of generating one horse power hour in station.

$r =$  ratio of average power required to maximum power required.

$L =$  interest and depreciation on supporting structure.

This last may be omitted from the calculation, determining division of line into sections, since it remains the same, whatever that division may be. Omitting this, the expression for cost of transmission becomes.

$$\text{Cost} = \frac{760,320 n^3 h K r}{(E-V) v \times 140,160} + \frac{b n h K A}{r(100-A) 100} = \frac{5.42 n^3 h K r}{(E-v) v} + \frac{b n h K A}{r(100-A) 100} \quad (2)$$

Supposing that the time schedule of trains, H. P. required per train, and efficiency of motors be known, and that the initial E. M. F. be in all cases taken as high as the state of the art permits, the only variables remaining in this expression are  $n$ ,  $b$  and  $A$ . This latter, the value for the drop on the line, will generally be determined by conditions other than those of strictest economy, as shown by getting a minimum value for cost of transmission. We must have a reasonably uniform E. M. F. all along the line, in order that the motors may work satisfactorily. It will not be wide of the mark to assume 10 per cent. as a limiting variation of line potential. This is the figure generally assumed in calculating wire for street railways.

The cost of one h. p. hour  $b$ , must vary with the capacity and conditions of working of the station; hence it is a function of  $n$ —*i. e.* length of unit section of  $A$ , and of that

TABLE IV.—FOR DOUBLE METALLIC CIRCUITS, COPPER INVESTMENT FOR TRANSMITTING ONE H. P. ONE MILE.

Drop on line, volts.	Initial E. M. F.															
	500	1,000	1,500	2,000	2,500	3,000	3,500	4,000	4,500	5,000	5,500	6,000	7,000	8,000	9,000	10,000
100	19.00	8.44	5.42	4.00	3.20	2.60	2.20	1.80	1.60	1.44	1.40	1.28	1.10	0.98	0.84	0.76
200	13.66	4.80	3.42	2.12	1.64	1.34	1.14	1.00	0.88	0.78	0.70	0.64	0.56	0.48	0.42	0.38
300	19.00	3.60	2.12	1.50	1.20	0.94	0.80	0.68	0.60	0.54	0.48	0.44	0.36	0.32	0.28	0.26
400		3.20	1.72	1.20	0.92	0.72	0.60	0.52	0.44	0.40	0.34	0.32	0.28	0.24	0.22	0.20
500		3.00	1.50	1.00	0.76	0.60	0.50	0.40	0.36	0.34	0.30	0.28	0.22	0.20	0.18	0.16
600		3.20	1.40	0.92	0.66	0.54	0.42	0.34	0.32	0.28	0.26	0.22	0.20	0.16	0.15	0.14
700		3.60	1.34	0.82	0.60	0.46	0.38	0.32	0.28	0.24	0.22	0.20	0.16	0.14	0.12	0.10
800		4.80	1.34	0.80	0.56	0.42	0.34	0.30	0.26	0.22	0.20	0.18	0.14	0.12	0.10	0.10
900		8.44	1.40	0.76	0.54	0.40	0.32	0.28	0.22	0.20	0.18	0.16	0.14	0.12	0.10	0.08
1,000			1.50	0.76	0.50	0.36	0.30	0.24	0.20	0.18	0.16	0.15	0.12	0.10	0.08	0.08
1,200			2.12	0.80	0.48	0.34	0.28	0.22	0.18	0.16	0.14	0.12	0.10	0.08	0.07	0.07
1,400			3.42	0.90	0.48	0.33	0.26	0.20	0.18	0.14	0.12	0.10	0.08	0.07	0.06	0.06
1,600			1.12	0.52	0.34	0.24	0.20	0.16	0.14	0.12	0.10	0.09	0.08	0.06	0.06	0.06
1,800				0.60	0.33	0.24	0.20	0.16	0.14	0.12	0.10	0.09	0.08	0.06	0.06	0.06
2,000				0.76	0.36	0.24	0.21	0.18	0.15	0.12	0.10	0.09	0.08	0.06	0.06	0.06
2,400				3.20	0.52	0.28	0.20	0.14	0.12	0.10	0.08	0.06	0.05	0.04	0.04	0.04
2,800					1.34	0.28	0.20	0.14	0.12	0.10	0.08	0.06	0.05	0.04	0.04	0.04
3,200						0.73	0.30	0.18	0.12	0.10	0.08	0.06	0.05	0.04	0.04	0.04
3,600							0.54	0.22	0.14	0.10	0.08	0.06	0.05	0.04	0.04	0.04
4,000								0.36	0.18	0.12	0.08	0.06	0.04	0.04	0.04	0.04
4,500									0.60	0.16	0.10	0.06	0.04	0.04</		







**Feed Water Heater and Purifier.**

Those in charge of the power houses of electric and cable railways are being constantly bothered by accumulations of scale in their boilers—a scale which is a non-conductor of heat and, which, consequently, necessitates the consumption of a

We show here, in Figure 1, a vertical heater and filter, combined, which consists of an iron vessel of suitable size into which the escape steam from the engine is exhausted. The cold water intended for the boiler enters the heater at its top, and, in the downward passage to its outlet is thoroughly boiled, a process which liberates the free carbonic acid, sets free the salts held in solution, and precipitates them upon suitable removable surfaces provided for their reception.

The construction of the heater is such that not a drop of water can possibly pass down through it without being boiled; the deposit is, naturally, always heaviest on the top, or upper shelf, and it diminishes in quantity as it approaches the lower, from which lower shelf the water passes through the filtering chamber, and is then sufficiently pure to enter the boiler and do its work without causing any deleterious results.

Figure 2 shows a live steam feed-water purifier of the horizontal type and is especially adapted to fill the bill where the water contains simply carbonates of lime or magnesia.

Figure 3 (which was made from a photograph) shows the deposits of lime and other impurities which were removed from one of these purifiers in use on the 300 H. P. boilers at the city water works, in Dayton, O. It can readily be seen, that had the boilers not been properly protected by means of this device, that these deposits would have been residue inside of the boilers, and the damage to the shell would have been very great, to say nothing of the enormous waste of fuel that would then have been necessary to bring the feed-water up to the required temperature.

**Construction of Central Stations.\***

BY C. J. H. WOODBURY.

While acting in co-operation with a committee of the National Electric Light association, several years ago, it was necessary to examine into the matter of the construction and surroundings of a large number of electric lighting stations. Although these stations were built for the same object and contained machinery and motive power devoted to the same industry yet there was a diversity in their characteristics which was wholly inconsistent with their similarity of purpose.

In accepting the invitation of your president to present a

Many of the electric lighting stations in large cities have been built under easy financial conditions, where it was feasible to adopt suggestions for convenience, strength and safety offered by the engineers in charge of such work. Notable examples of such stations have been presented before this association, or illustrated in the electrical journals. The opportunities for large stations have thus far been so few, and the governing conditions so diverse, that the problem requires in each instance an independent treatment, and is therefore unsuited for a general paper on the subject.

The larger part of the electric light stations are of moderate size, and were constructed under conditions of limited resources which often compelled parsimony in the reduction of first cost, and did not permit the exercise of that judicious economy which yields the greatest return on investments.

A most important element in the arrangements of a central station should be guarantee of continuous operation, in order to give patrons a necessary confidence in the stability of the service, which must be instantaneously equal to the maximum demands of customers.

Many of the stations are in close proximity to other

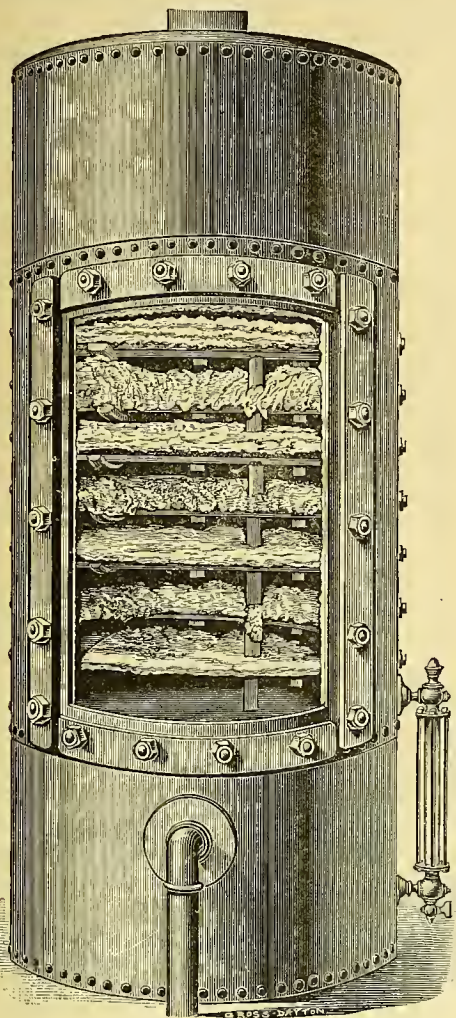

FIG. 1.

vast amount more fuel in order to properly heat the water, than would be required were the boilers free from scale and incrustation.

Every engineer in charge of a steam-plant, knows, to his cost and annoyance, that, when the feed water is pumped into the boiler without being first purified, and the lime, sulphur, magnesia, or whatever of such impurities it may contain, eliminated therefrom, that the heat soon frees those impurities, which then become precipitated upon the inner surface of the boiler shell, as well as upon the flues, thus forming a non-conducting surface, of various degrees of thickness to be interposed between the water and the boiler shell and causing, to a greater or a less degree priming, or foaming of the boiler, which makes grit to work over with the steam into the most delicate parts of the engine, an excessive waste of fuel, a rapid deterioration of the boiler-shell from burning and corrosion, and not infrequently, an explosion.

In order to guard against the heavy item of expense, and maybe, loss of life, from the damage thus done, the genius of invention has been directed toward devising certain arrangements, whereby the cause may be prevented, or removed, and when we take into consideration the fact that a scale of the thickness of 1-16 of one inch will necessitate the extra expenditure of 15 per cent. more fuel, it can readily be seen how important a problem has been left for inventors to solve.

Stillwell & Bierce Mfg. Co. Dayton, O.

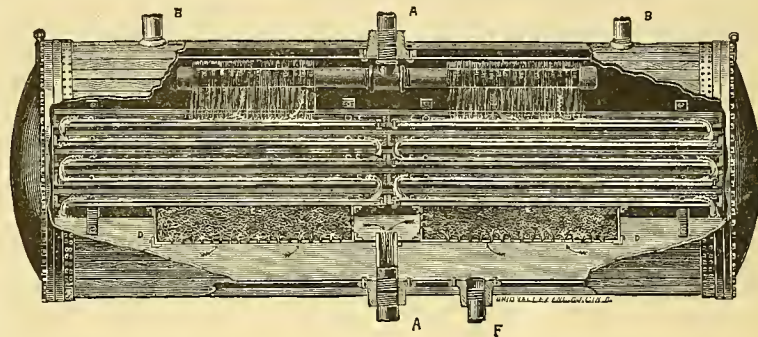

FIG. 2.

buildings of a miscellaneous character, and are built with hollow frame walls and tin roof, forming a structure which is hot in summer, cold in winter and combustible all the year round—which disadvantages diminish dividends.

The location to be desired for a station should be, first, away from a proximity to other buildings, and therefore free from a fire hazard due to surrounding exposures. It is important that the engines should be provided with an independent condenser, but it is not necessary that the station should be near a water course to obtain a supply of water for the condensers, as is the universal custom in this country. A reservoir of suitable capacity, and not over eight feet deep, will furnish a supply for condensers, which can be used over and over; the condensed steam and hot water entering one side of the reservoir, and the supply for the condenser being taken from an extreme side. If the water should not cool rapidly enough, it could be delivered from the condenser upon the top series of several nearly level platforms, and thus flowing upon one and thence to the next in turn. In this way the water rapidly cools. Although the condensing capacity of such reservoirs might differ in this country on account of climatic differences from European practice, yet it is well to note that in winter when the short days cause the greatest demands upon a central station, the condensing capacity of such a reservoir would



FIG. 3.

paper for consideration at this meeting, it appeared that the subject of central station construction might be a profitable one—not by reason of what may be contained in such a paper, but on account of the valuable experience which would surely be offered by the members participating in the general discussion of the subject, and in such a connection this paper is to be regarded as the opening of the discussion, hardly more than a parliamentary necessity, in order to bring this subject into a debatable form.

\*Read before N. E. L. Ass'n.

be greatly increased by reason of the more rapid loss of heat during cold weather.

In its general arrangements, a central station may be regarded as an engine room, and if well adapted to engines and the delivery of power, there can not be much difficulty in providing accommodations for dynamos. The type of building suggested for consideration in its application to central station service in small cities, is the one story slow burning construction, with flat roof lighted by a longitudinal monitor, one end of which extends high enough to



form a wire tower. It is not claimed that there is anything original in this design, beyond a few minor modifications pertaining to its application to this specific purpose, for it is well known that beginning with one story machine shops over twenty five years ago, foundries, textile and paper mills, on the same general idea of construction, have been widely introduced, wherever the cost of land was low enough to permit the erection of a one-story structure without raising the whole cost of the floor area, including the expense of land, to a price exceeding that of a high building.

Franklin once said that next to a good foundation a good roof was the most important part of a house. The question of roof will next be considered, leaving the intervening pillars and walls for later reference.

The most convenient width for stations using an engine to every pair of dynamos is forty three to forty-five feet, and the length of the station is in proportion to its capacity. The roof should be of three-inch plank, each twenty feet in length, grooved and spliced with hardwood splines one-half by one and a half inches, and laid on roof timbers breaking joints every three feet. In colder parts of this country, liable to temperatures below zero, it is good economy to lay a course of inch boards upon the plank, with roofing felt between. Pine is preferable to other lumber for roofing, as it does not warp so much as other soft lumber, and the roof covering will last better. The roof covering may be of any material for covering flat roofs, but its value will depend upon the quality of the material and the character of the work.

If these methods are followed, such a roof can be relied upon not to give trouble by condensation of moisture in cold weather, but care must be taken not to drive nails up into the plank, because, being good conductors of heat, the heads would be cool and moisture collect on them.

Along the middle of the roof, a monitor ten feet wide, extending to twenty feet from the ends, will afford light and ventilation, while an extension of this monitor at one end to a suitable height will form a most convenient wire tower, if the monitor, in connection with an outrigger, should not be high enough for the purpose.

The roof timbers should be of southern pine, ten by twelve inches, and laid ten feet on centres. They should project eighteen inches beyond the walls, and the ends be cut to form brackets supporting the overhanging roof and forming a solid cornice. At the ridge, the two beams should be secured together by a junction bolt, and supported by column and bolster.

The walls of the station may be built of brick or of wood. If of the former, a twelve-inch wall will answer, with windows arranged as may be desired; but if of wood, each roof timber should be supported on an eight by eight inch timber reaching to the sill, and secured to the roof timber by an iron brace, and to the floor timber by iron dogs.

If the building is to be used for apparatus generating low tension currents, the best floor would be made by laying coal-tar concrete on a foundation of broken stone or cinder, and then laying three-inch plank upon the concrete, and covering this plank with one and a quarter inch hard wood plank laid across the bottom plank and blind nailed to it. Such a floor would sustain any weight liable to be placed upon it, but where there is need of a mass to hold rapidly moving machinery, it could be cut away wherever it might be necessary to lay heavy foundations.

On the other hand, if the generation of high tension currents in the station imposed electrical conditions requiring a higher insulation of the floor, such as could be obtained only by an air space underneath, then it would be necessary to enter into a larger expense, and to lay a mill floor by placing the two thicknesses of planks on beams in a manner similar to the method described for the roof.

If the dynamos were placed on independent foundations, this floor would be strong enough, but if it should be required to sustain very heavy loads, there should be a line of piers supporting the beams under these loads. The lower portion could be made into a supply-room; or otherwise, the front of the building could be divided by a light sheathing partition into a supply room and an office.

In its appointments the buildings should be heated by two coils of three lines of one and a quarter inch pipe, each hung about three feet below the roof timbers, the arrangement of piping using exhaust steam for such a building being about one foot of one and a quarter inch pipe to every seventy cubic feet of space. Two coils are suggested because the side occupied by the steam engines would rarely need any heat from the pipes.

The roof timbers afford easy means of securing a trolley track for making any changes and removing the apparatus or parts of the engines.

The protection against fire consists principally in keeping the establishment in a clean and orderly condition, the use of good lubricating oil and careful attention to the bearings; and beyond that, numerous fire pails kept filled with water, and hose connected to hydrants ready for instant use, form the means of protection against fire.

If the boiler house is placed at one corner of the station, the latter can be extended by increasing its length; but if the boiler house is placed at the end of the station, the division wall should be made of brick and extend through the roof, entirely cutting off all wood communication between the station and the boiler room.

The wires could be run from the dynamos diagonally upward to the roof timbers, thus clearing the trolley track, and thence under the monitor from beam to beam to the switch board on the floor under the front end of the monitor which forms the wire tower. This switch-board would be at the end of the unavailable floor space used for belts, and being in the middle of the room is away from the walls, where any combustible material is likely to be placed. It is important that the switch board should be made of soapstone or other incombustible material.

It is submitted that a station built in accordance with these general suggestions would embody the merits of convenience in operation, slight need of repairs, and, whether built with brick or plank walls, would possess a resistance

to fire which would reduce the fire hazard to a nominal amount; and although not so cheap in its first cost as might be made by using a lighter construction, yet, as a whole, it would conform to the strictest conditions of economy in a building to be used for a central electric lighting or power station.

### Electricity Supplants Steam.

The subject of electric railroading has received a great deal of attention in the Southwest, and this part of the country is fully awake to the advantages of electric power for car propulsion.

The State of Texas has two electric railways in operation on the Sprague electric system and others are in course of construction. One of the roads in operation is the Dallas Rapid Transit Railway, a view of which is shown here.

The motive power for operating the cars on this railway was formerly furnished by a steam dummy, which has now been abandoned for the more modern power.

Our view shows one of the electric cars drawing the old steam dummy. The engraving was made from an instantaneous photograph, and shows the ex-engineer of the steam engine trying in vain to catch the train, which is going so rapidly that he is left behind.

An interesting circumstance in connection with this view, which shows very clearly the easy manipulation of the electric car, is the fact that

good estimate of their operating expenses. The best discussion of this which has yet appeared is the recent paper of O. T. Crosby. His results are worth the careful study of any one interested in the particular study now before us, and while some of his data were necessarily imperfect, they give a very good general idea of the facts.

Some recent changes in street railway practice may prove suggestive in this connection. First, we must notice the growing use of large and powerful compound wound generators. An ordinary shunt wound machine is ill suited to railway service, on account of the very great variations in load, and consequently in voltage; nothing short of compound winding can or does keep the voltage reasonably constant, and the change is a most decided improvement. Beside this, voltage in general use has been constantly rising. Less than two years ago a well-known electrician said that he did not favor the use of more than 400 volts for railway work; there are now a few roads on which from 525 to 550 volts at the station is the rule, and pressures as low as 400 volts at the station are quite the exception. This increase of voltage is probably a distinct advantage. In the early days of electric railroading, a couple of years ago, the art of insulating armature and field coil was by no means as highly developed as it is now, and I think we shall soon reach the point where the voltage used for railway work will only be limited by considerations of public safety, and only, therefore, when overhead circuits of bare wire are used. It is gratifying to learn that at the Kansas City convention it was agreed to adopt, as far as possible, a uniform standard of 500 volts for railway work. We are quite certain now that 500 volts can not be classified as a dangerous potential, at least if the current is a continuous one; how much higher than this the limit of safety lies we do not know, though it is quite certainly below 1,000 volts. Increased voltage means increased efficiency in distribution and increased efficiency of motors if we can secure the

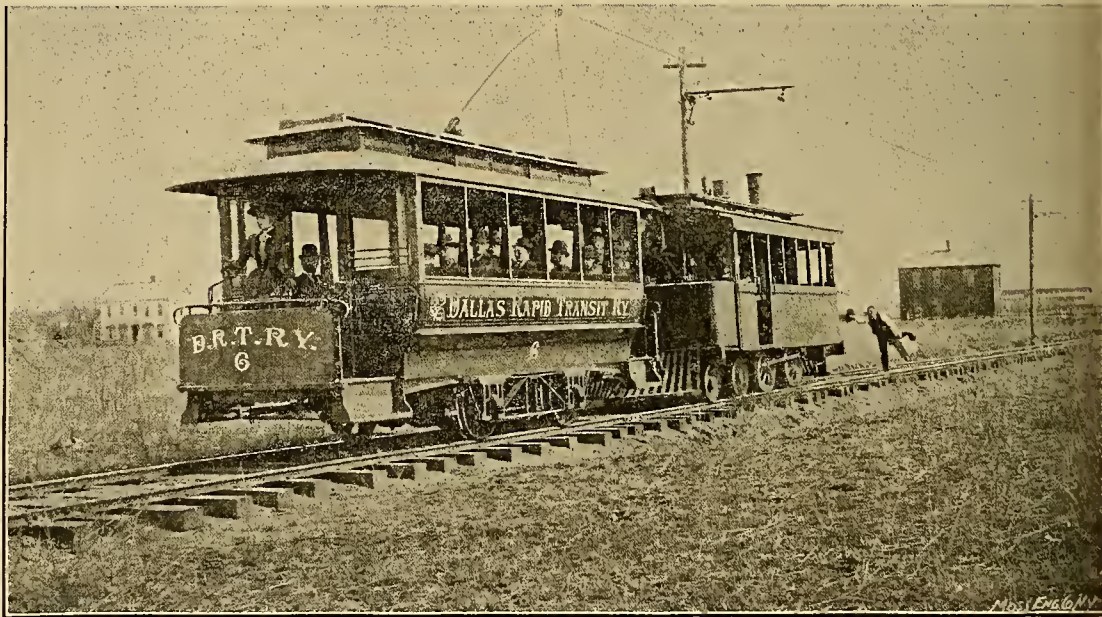

the motor car is being operated by a young lady, who is in charge of the controlling switch, while another young lady is acting as conductor. By way of comparison, it might be mentioned that the steam dummy required an engineer and fireman to run it beside a train conductor on the train.

### Electric Motors in General Railway Work.\*

BY DR. LOUIS BELL.

The title of this paper makes it sufficiently evident that I do not intend to indulge in retrospection, except in so far as is necessary for illustration, but shall turn my attention to what is now a probability of the future.

The electric motor for street car service is an accomplished fact, as some hundreds of miles of road in daily operation bear witness. So far as practical success is concerned, the electric railroad is past the experimental stage, and is in the beginning of the commercial era. Many improvements will be made in the future, as they have been in the past, and the directions which some of the improvements have taken suggest and emphasize the probabilities I am going to discuss to-night.

First we must notice that, in a large measure, the running of single cars has been abandoned, except on small roads and heavy grades. A good proportion of electric railroads now regularly use trailers attached to their motor cars, and sometimes trains of two or more; to meet this demand for trains rather than single cars, a heavier type of motors has been introduced, and even heavier ones are being projected. A powerful motor, with a couple of trailers attached, can not fail to suggest to the mind a possibility of a still more powerful car at the head of a procession of a couple of baggage cars, two or three day coaches, and as many more sleepers. Enough experiments have already been tried to show that motors nearly, or quite, as powerful as an ordinary locomotive can be readily made and handled. The power is in our hands, the possibility of using it on a grand scale seems nearer day by day, and we call up the aforesaid procession of cars to our minds' eye, and instinctively ask ourselves, why not?

Beside knowing the general properties of our present electric railroads, we are now in a position to make a fairly

\* Read before the Chicago Electric Club.

necessary insulation. If we are ever to use powerful motors at a long distance from the generating station, the necessity of high voltage is apparent. The possibility of using high voltages need not be questioned, for in the experiments of Deprez, and the more recent experiments at Kriegsteden, potentials of from two to nearly six thousand volts were quite successfully used. The necessity for high voltage may compel us to use Gramme armatures to secure insulation, but there is no serious obstacle. Another recent important improvement in motor work is the very general use of carbon brushes, which has facilitated the operation of railway motors in a most remarkable manner. I mention these various improvements because they apply directly to the problem we are to discuss: The transmission of large amounts of power over considerable distance to fast running trains.

In looking at the possibility of handling trains with motors, two questions naturally arise before we can even consider the advisability of attempting it. First, can we readily build a motor to handle railroad trains at railroad speed? To this question, I think we can unhesitatingly answer, yes. The experiments of Mr. Daft on the New York Elevated Road make it very clear that we can build motors large enough to do the work with every hope of success. In those experiments trains of the ordinary weight for elevated work were readily handled at a speed higher than that required by schedule time. Aside from this, stationary motors of equivalent size are already in use in mining operations. In fact, with large motors, say from 50 to 150 horse power, we should expect to obtain rather greater efficiency than in the sizes more generally used. We should expect, theoretically, to obtain a rather higher weight efficiency with the larger machines. In practice very many manufacturers do not increase the weight efficiency with the size of machine. The reason for this I do not know; possibly because a machine of lower weight efficiency is some times cheaper to build. This question aside, there are certain advantages of a practical nature in using these large motors. When a motor becomes too large to be put under an ordinary car body, and a special motor car is constructed to hold it, it works under conditions very much more favorable to smooth and successful running, for it is far less exposed to accident and continual small troubles arising from dirt than an ordinary street car motor. Then, too, it is possible, not being cramped for space, to arrange the whole motor outfit in such a way that it can be given close and careful attention.



The second question before mentioned is, can we rely on a motor with anywhere near the same feeling of certainty as on a locomotive? A couple of years ago we should have been compelled to answer this question in the negative, but the great and rapid improvements that have been made in insulation and the various details of construction, make one hesitate in giving that answer. We must remember that dynamos of corresponding size are in daily use, and frequently run months many hours a day, without the necessity of shutting down for any purpose whatever. Given a powerful motor, placed in a motor car, where it can have as close attention and as watchful care as any dynamo in a central station receives, and I know of no reason why it should be subject to break-downs or require frequent repairs; to be sure, a motor is subjected to sudden and violent changes of load, but if well-made to begin with and well taken care of. I do not think we should have good reason to fear its being unreliable. The case is not at all comparable with that of ordinary street car motors, which, beside lacking even a reasonable amount of care, are subject to dirt and dampness to a degree that makes it wonderful that they do not break down oftener. A motor placed in a special motor car, and properly protected, ought to run as successfully as a stationary motor, and thus, unless grossly overloaded, give singularly little trouble.

Putting aside then these questions, as those can reasonably be answered in the affirmative, we come to another vital question: Can the requisite amount of power be transmitted, with a tolerable degree of economy, to the distances required? This question we are now in a position to answer. It is apparent, I think, at first sight, that we can not expect to distribute over very long distances without a frightful sacrifice of economy. The electromotive forces used are somewhat limited by the possibilities of insulation, and economy of long distance transmission can only be secured by very high electromotive forces or an enormous expenditure of copper. The immediate solution of this difficulty is to operate the line in sections of reasonable length, and this, of course, can easily be done. This at once raises the question, what is reasonable length? And to answer this question, we should have to investigate each special case in detail, for the most economical length of section would involve the relation between the loss of power in transmission over a long distance and the increased expense of shortened sections, a ratio which evidently involves too many variables to admit of a general calculation.

Let me take for illustration a special case: Suppose we wish to deliver 100 horse-power to a distant motor; let us assume 90 per cent. efficiency for both dynamo and motor, and we wish to transmit the power to a distance of ten miles on either side of the generating station, using a number of copper wire as a distributing conductor. We could deliver 100 horse-power at either end of the line, with an efficiency of somewhere about 50 per cent., and we should require about twenty four tons of copper wire for a complete metallic circuit. If the motor were moving at a uniform speed over the line, we should have a gradually increasing efficiency until the motor reached the generating station, and gradually decreasing efficiency after that, until it reached the further end of the line. The efficiency as it passed the station would be 81 per cent., and the mean efficiency over the whole line consequently about 65 per cent. In this case I have assumed, in addition, an electromotive force of 1,200 volts at the motor terminals at the end of the line, an electromotive force not at all impracticable for large motors. It is therefore clear that a twenty-mile section can be worked with a fair degree of efficiency, even using a conductor no larger than a number 6 wire. Using a large conductor, it would be possible to work a section considerably longer. I merely mention this instance to give an approximate idea of the losses of long distance transmission and will introduce a computation for a section of more practical length later.

A question that naturally comes up in this connection is, whether it might not be possible to obtain the best results by means of a constant current motor and generator. I am aware that I am trenching here on dangerous ground, but unless the doors are locked before I close this paper I have hopes of escaping in the melee. The mechanical difficulties of keeping a long line in order for real series transmission, are, I think, too formidable to make this aspect of the question worth discussing until they shall have been effectively disposed of for short distance work. If we were only operating, however, one motor per section of line; in other words, transforming the system into a real block system, I am not at all sure but that the constant current motor could be very successfully used, although its application to railroad work is as yet new.

(To be continued.)

### Electric Railway at Pittsburg, Kansas.

The Westinghouse Electric Railway Company is now building at Pittsburg, Kansas, what will be one of the model electric street railways of the country. Through the business portion of the city there will be a double track, with a single track for the suburbs.

The Street Railway Company has been given a valuable franchise and propose to utilize it in a manner that will show how a rapid transit surface railway can be built to the best possible advantage. Materials for the track are on the ground, cars and machinery will be ready when the track is completed, a handsome station is to be erected, and the whole work will be energetically pushed to completion.

### Heavy Travel.

The week before last clearly demonstrated the ability of the electric system of street car

propulsion to take care of enormous loads. In the cities the amount of travel imposed upon the electric cars was far in excess of that for which they were intended, but in spite of the enormous loads carried in each case, the operation of the cars was successful in every particular.

At Cleveland, on May 30, occurred the ceremonies connected with the dedication of the Garfield Memorial, and the city was crowded with strangers who took the electric cars to the park. The greater part of these people were carried on the electric cars over the East Cleveland Street Railway, though many passed over the line of the other two street railways in Cleveland. The cars on all three lines were crowded with passengers. Many of the cars ran trailers, and both motor car and trailer were taxed to their uttermost capacity.

In Buffalo on the following Sunday, the four electric cars in operation on the Buffalo Street Railway ran all day long, drawing one or two trailers each, and are credited with carrying in all over 15,000 passengers.

It is said that the managers of the roads in both of these cities are very enthusiastic over the operation of the cars, and the daily press has spoken in the highest terms of such a performance in the face of very trying circumstances.

### Horse Releasing Device.

A device whereby animals may be instantly released from the fastening in the stalls in the event of fire, or whenever desired, without the necessity of the operator entering the several stalls or even the building, has recently been patented.\*

The body of the device consists of a casing attached by means of a flange to the front of the stall or any suitable support within or adjacent thereto.

The casing contains a pair of tongues; these tongues are operated by means of an elliptical cone to which a lever is attached; this lever is provided with a kind of wrist by which the device can be operated singly or for any number desired. This lever acts both ways alike and has only a movement of 45 degrees. This double movement gives the advantage that the device can be operated from two different points.

If one point of the building is on fire the device is in perfect working order from other points.

The lever to which the wire is attached can be set to any angle to the casing, suitable for any purpose and locality in which the device may be used; also this lever has a slot which prevents all side-way motion of the wire and in this way the wire can be very easily protected from any interference whatsoever.

\*I. J. Kubatz, New York.

### The Steam Engine.\*

BY FRED E. SICKLES.

The theory of the steam engine has been so fully explained and is now coming to be so well understood, that it is scarcely profitable to take up the time in reiterating it here; but there are some mechanical defects in the steam engine which are yet to be remedied and which it will be well to mention. I shall not mention any one device which is covered by any patent in anything I have to say here now.

Every device that has yet been used to admit the steam and to exhaust it from the cylinder, under the general name of valves, has had its especial defects. The old-fashioned slide valve, involved a great deal of friction, and while this is meant to be remedied by balancing the valve, contrivances which have been applied to this purpose, though more or less complete, have not as yet balanced the valve, as the pressure upon it varies with the position of the valve. All attempts to balance the old fashioned slide valve with the rigid fit, without elasticity or some yielding arrangement, have proved failures. As in first applying the steam and warming the engine, the valves will warm faster at first than the surrounding steam chest and will jam if care is not taken to give ample time for the equal warming of all parts any want of care on the part of the engineer in this respect will tend to work injury by the cutting of the valve when at first starting the engine. In that form of piston valve, which has piston range, either one or two, the liability of leakage past the ring is encountered, especially as those rings cross the ports of the cylinder; and when attempts are made to work pistons with solid rings, then the difficulty of expansion is encountered. If a solid piston is used in the piston valve, it becomes necessary to make the piston slightly smaller than the bore of the seat to allow for the unequal expansion when first starting the engine.

The many ported slide valve gives ample opening with but little motion, but it has extended edges to permit leaks, if not carefully fitted. The rotating slide valve with a

\*Read before N. E. L. A.

raised seat is difficult to get at, to keep tight, although it presents some advantages in connecting the valve motion to it. With balanced poppet valves the difference of expansion between the valves and chest is liable to create a leak, but if great care is exercised in fitting this kind of valve, and an ample guiding surface is allowed above and below on the stem, and the seats are made of not more than an angle of 22 degrees from the vertical line, with the valves and chest cast of metals of substantially the same rate of expansion, the valves can be made to remain reasonably tight. Yet, if great care is not taken in the adjustment and shape of the rock shafts for opening and shutting the valves, they are liable to make an unpleasant noise when running at any rate of speed. The single poppet valve can readily be made to work tight for a reasonable length of time, but there is the same objection to it as in the double poppet in regard to making noise at high speed. In addition to this it requires heavier valve gear, because, just at the instant of opening it offers great resistance. They do not waste as a whole, as much steam as the double poppet valve. They can be arranged to have less clearance between the cylinder and valve. Indeed, single poppet valves have been placed directly upon the cylinder heads, thus giving very slight clearance. This plan has not come into use, owing probably, to want of better adaptation of the details of the mechanism. The whole subject of valves for steam engines presents a field for ingenuity.

It may be expected that the speaker will give some account of the trip cut-off valve, with which his name has been identified for one half of a century. To do so fairly I shall have to state the requirements of a perfect cut-off, which really can not be secured, and the trip cut off is only an effort to reduce the loss occasioned in working the cut-off. To describe this loss I will state that steam may be assumed to have two different powers. One power is derived from the force it exerts in pressing against the piston as it escapes from the boiler into the cylinder. The other is the force it exerts after communication has been cut off between the boiler and the cylinder in expending and continuing to exert a diminishing pressure upon the piston. When the steam has exerted nearly the whole boiler pressure at one-fourth of a stroke, and it is then desired to cut off the steam so as to obtain all the power that can be derived from the expansion of the steam already in the cylinder, the communication between the boiler and the cylinder would have to be instantaneously closed, so that the power derived from expansion in the cylinder might begin at nearly the boiler pressure and continue to exert a diminishing force to the end of the stroke. Any mechanism yet devised can not instantaneously close the opening, for two reasons. First, it would be impossible so far as we know, to put any machinery in motion sufficiently rapid to instantaneously close the opening; and second, if this rapidity of motion could be obtained, it would be impossible to absorb the momentum of the parts in arresting this very rapid motion. The best we can do in this regard is to devise some arrangement which will move as fast as it is practicable to move mechanism, and then absorb the momentum of these parts in such a manner that no destructive violence will occur in arresting their motion. In the trip cut-off, the valve is liberated from the opening mechanism and is forced shut by a spring or elastic force, as shown in the original patent; and in fact, in the original patent the elasticity of the spring and the elasticity of the steam are used to force the valve shut as rapidly as it is practicable to do so. The mechanism for absorbing the momentum of the parts may be explained by referring to what we see every day. We see that water and air in their action upon the earth disintegrates and destroys its surface, in time, while neither the water or air is injured by the violence. All the storms that have beaten upon the ocean have not injured one drop of water, while the air and water have washed and disintegrated the shore line of all the continents. Hence, it is reasonable to infer that if the violence of the momentum occasioned by the use of the trip cut-off on rapidly closing could be absorbed in the motion of a fluid, whether water or air, a practical working machine would then be secured. It is only necessary that the valve in closing shall work some device like a plunger or piston which shall have this property, viz: That it shall move freely in the fluid while the cut off valve is closing, but at the moment of the closure it shall encounter the fluid by confining a portion of it. How is the power lost in the case of a locomotive that at one moment is developing 400 horse power with full boiler pressure and having been suddenly flagged to stop is during the next minute exerting no power through the cylinder (in the meantime the pop valve has jumped wide open and steam is escaping violently through it)? The power of the steam is lost after the engine is shut off in forcing the particles of steam past the blow-off valve into the open air. In the same way, while the cut off valve is slowly closing, the power is absorbed in forcing the particles of steam past the cut off valve. It might be well for those who have yet to believe in the efficiency of the trip cut-off, and among these are some of the very best mechanics of the present day, to try the part which I presume they will have the most doubt about, that is, the checking apparatus or dash pot. If they will make a controlling vessel, so arranged that it will permit the fluid to escape freely until it is desired to arrest the momentum by confining a portion of it and forcing it through a narrow orifice of any sort, and will watch its action by letting it run in a shop or other place for any length of time, they will be entirely satisfied as to the reliability of the checking apparatus. In regard to the tripping apparatus, one objection is the use of a spring in the valve motion of a steam engine. It may be well to mention that it is not necessary to have a spring, as a weight will answer to re-engage the trip, or a positive motion can be secured; but springs or weights are generally used and as springs are shown in the original patent, it may be well to consider the question of springs. The elasticity of metal is one of the laws of metals, as fixed as the law of gravity, and much of the prejudice against springs has been

(Continued on page 96.)



# The Street Railway Gazette.

S. L. K. MONROE, - - - - - MANAGER.  
E. V. CAVELL, - - - - - EDITOR.  
EDWARD J. LAWLESS, - - - - - ASSOCIATE EDITOR.  
W. L. S. BAYLEY, - - - - - MECHANICAL EXPERT.

## GENERAL OFFICES:

### CHICAGO:

8 LAKESIDE BUILDING.

AGENCIES { San Francisco, - - - 1222 Bush Street.  
Toronto (Canada), - - - 53 Magill Street.

Cable Address=TRAM, CHICAGO.

### Annual Subscription (Including Postage). Per Copy

United States, Canada	\$2.00.	25c.
Great Britain, Ireland, India, Australia	10s.	1s.
Germany	9mk. 75 pf.	89pf.
France, Belgium, Switzerland	2fr. 95c.	Fr 1.10.
Spain	21ps. 95c.	Pa 1.10.
Austria, Holland	6fl. 74c.	55c.
Italy	12 lire.	1½ lira.
Venezuela	12 bolivars.	1½ bol.
Mexico	\$3.00.	80c.

Annual Subscriptions in Argentine Republic, 2½ peso; Brazil, milreis; Turkey, 54 piastras.

[Entered at the Chicago post-office as second-class matter.]

\* \* \*

Matter for publication should reach the Chicago Office not later than the last day of each month. All communications should be addressed, THE STREET RAILWAY GAZETTE, Chicago, Ill.

## In Union There is Strength.

We live in an age in which we have outward and visible proof that the name of the believers in the time-honored "Union and Strength" saw is "Legion." From week to week, and from all corners of the Street Railway field come echoes of consolidations that have already been effected, and rumors of amalgamations still in an embryonic state.

Several months ago it was currently reported that the Thomson-Houston Electric Company and the Sprague Electric Railway and Motor Company had come to some kind of a mutual understanding — later a consolidation of all the various Edison interests was perfected.

Prior to this both the Thomson-Houston and the Westinghouse Companies had been gradually absorbing other electric concerns: now the announcement comes that the Pullman and Westinghouse Companies are about to enter into some kind of a combine or alliance, thus bringing the car building and street car motor interests in closer connection.

From St. Louis, news reaches us that certain capitalists are endeavoring to harmonize the three street car building establishments there, and cast them into a common pool. From New York comes the intelligence that the Julien Electric Traction Company and the Draft Electric Light and Power Company have united their interests under the name of The United Electric Traction Company.

To what end will this gradual uniting and blending of street railway interests come? What will be the effect upon prices, upon the quality of the goods turned out by these various combines? If higher prices obtain, then surely should the standard of excellence of the goods manufactured be raised accordingly. Time alone can show what the ultimate result of the existing trend towards a unity of similar interests may be, but we incline to the belief that it will prove beneficial alike to the producer and the consumer.

(Continued from page 95.)

created by using them beyond their safe elastic limit; and when this is done, then the spring becomes an unreliable means of working mechanism. This fact may be illustrated by referring to an ordinary watch. The main spring of a watch frequently breaks, but the hair spring, never. Yet the hair spring is put in tension and compression from three to five hundred thousand times in twenty-four hours. And the reason is, the main spring is taxed beyond its safe elastic limit, and the hair spring is not so taxed. In cases where springs are used, if this consideration is kept in mind the spring can be made reliable within a reasonable limit. By applying this mode of reasoning to the trip cut-off, the remedy is obvious. The force necessary to re-engage the catch is so very slight, it is quite easy to make a spring that in performing this office, while not nearly taxed to its safe elastic limit, can therefore be relied upon with reasonable certainty, to work the catch. If any good mechanic may yet be in doubt as to its certainty, it is an easy matter to add another spring and catch, so that one will act in case of failure of the other. This was the plan adopted in the original patent to overcome one objection that was anticipated against the use of the spring in working any part of the valve motion in the steam engine. An examination of the model in the Patent Office, under date of May 20, 1842, will show these double springs. It is difficult to change the opinion of any mechanic except by illustrating. As there are now no patents upon it, it is public property. Probably the best way for inquiring engineers would be to test the catch or checking apparatus, and it will be found that they are entirely reliable as a practical question.

(To be continued.)

## Single and Double Trolley Wire Systems For Electric Railways.\*

GEORGE W. MANSFIELD.

In addressing you this evening on the subject of "Single and Double Trolley Wire Systems for Electric Railways," I shall endeavor to place precisely before you the advantages and disadvantages of each system. The other day while studying over the subject, the following questions arose in my mind: Why should I spend any time whatever in discussing the two systems? Is it necessary? If so, why? I think my telephone friends here could answer that question perhaps.

The antagonism of the telephone companies to the single wire system has become universal and their love for the double wire system proverbial. This opposition has provoked much discussion, and led to deep thought. My own thinking and experience has forced me to the solid conviction that for an efficient electric railway system which can be universally used the single trolley wire is the only one to be considered. Being then of this conviction, the time I spend upon the double trolley wire system is purely educational for my dear friends in the telephone companies, and I trust I merit their hearty applause since they all tell me they want electric railways and the best.

The principles involved in the construction of a single trolley wire system are familiar to you all. You know that it can be done successfully, and is done successfully. Do you or does anyone know that under all the conditions under which the single trolley wire works successfully the double trolley system will also work successfully.

If the difficulties with the single system have all been overcome and those of the double system have not, let us consider what we must take into account to make the latter equal the former.

With the double system the weight of the second wire the insulators, frogs, crossovers, etc., the double liability of sleet and ice accumulating on the two wires, and the high winds all necessitate larger and stronger poles and stronger spans, pull-off and anchor-wires, etc. This increase in size and number of wires means additional unsightliness, a larger original outlay and an increased expense for maintenance.

One of the chief troubles which an electric railway has to contend with is to keep its wire free from snow and ice during the winter months. Prompt and energetic action, with a greased trolley wire has saved the single trolley roads from any serious delay. If these same roads had had two wires to clean, I have no question but that their service would have been seriously impaired if not entirely stopped.

I do not think that the question of traction is one of any serious moment. The rails must be cleaned for adhesion and for the cars to keep on the track irrespective of whether the single or double trolley wire system is used, and as they are get-at-able they are comparatively easily taken care of. It is simply a question of management, muscle and salt, and with improved electric sweepers and plows there need never be any great difficulty in keeping the cars running on schedule time.

The problem, however, of cleaning sleet frozen to a trolley wire placed eighteen feet above ground in a large city or even on a country road is a most annoying and troublesome one.

One, if not the greatest difficulty, which would have to be overcome with the double trolley system, is the liability to leakage. The two wires hanging side by side upon the same span wire need the best of insulators. Considering all the atmospheric conditions and the possible accumulation of sleet and snow, it unquestionably would be more difficult to maintain good insulation between the two wires than it is between the single wires and the ground. With the latter system you have far greater opportunities to introduce additional insulation. It can be cut into the span wire or placed on the pole, whether it be of iron or wood.

So far the under-running double wire roads have had the wires placed either six inches or eighteen inches apart. The Draft road employ the former distance, while the Thomson-Houston Company in its attempt at Cincinnati used the latter distance. Both methods have their objections. If the wires are placed too near, strong winds may swing them

\*Read before the Boston Electric Club.

together, causing short circuits. In one place the short circuit was so heavy that the wires were melted and fell into the street. With the wires farther apart plainly this trouble would not exist. With the wires close together a single trolley-arm can be used, but a double trolley fork and two wheels are necessary. These wheels must be thoroughly insulated whether they rotate upon a separate or upon the same spindle. The maintenance of an insulation sufficient to withstand 500 volts under such conditions is surely not an easy task.

With the wires further apart the necessity of more than one frog at the crossings and the turnouts is necessary, which is objectionable, and more than one trolley arm would have to be used. The maintenance of these trolley arms, the difficulty of keeping them on the wires, and their weight upon the roof of the cars are all serious objections. In the single wire system questions of weight, insulation of trolley wheels, etc., practically do not enter.

Another serious objection to the double system is in the overhead switching. The placing of overhead frogs even on the single wire system requires the greatest exactitude and care, so much so that on many roads it has been found necessary to train a special gang of men to place and look after their adjustment. The expansion and contraction of the wires and the giving and taking of the poles are constant sources of annoyance and trouble in keeping the frogs and insulators in place. The expansion of copper is one-eighth inch per degree for 1,000 feet, or five eighths of an inch per mile for each degree of change in temperature. If the temperature changes, as it often does, twenty or thirty degrees in a day, the trolley wire might expand or contract fifteen or twenty inches per mile. With the double trolley wire system the location and maintenance of the frogs on the crossovers and turnouts would, in view of these circumstances, be an extremely difficult one. They would require constant adjustment and re adjustment and if the method of placing the trolley wires eighteen inches or more apart was employed, so that a large number of frogs was introduced, it would practically be a determining factor between the possible and the impossible system.

On complicated systems of double track lines, the number of insulators and frogs for the double wire system would be very large. I have frequently studied such systems and have found that it is by no means a rare occurrence to meet arrangements of tracks that require from twenty-five to fifty overhead frogs and insulators, and in some instances from 125 to 150. The weight of all these necessarily demands a most substantial overhead construction, and undoubtedly the only thing that could be done would be to erect a large and substantial trusses. It must be also evident that the difficulty of keeping the trolley wheel upon these wires is largely increased and also the liability of some of the ends breaking loose from the frog and falling.

Imagine such a network of wires loaded with ice on a winter's morning. Add to these wires, if you will, the necessary guard wires, and it is as essential to put up guard wires, with the double system as for the single, and I for one would not have sufficient audacity to argue for the same before a city council. It can also be clearly shown that the wires of the same polarity of the double system will not in all conditions correspond when they are attached to the frog. To illustrate what I mean, take the single track Y. If a sketch of this is made on the double wire system, it will be seen that if the right hand wire is a positive wire and the left wire a negative wire on a straight piece of track, and they are carried around the Y on to a branching track, the positive and negative leads are bound to conflict. Under such circumstances either the current must be broken on the motor when the car passes that point, or there will be bad flashing in the switch.

It is practically impossible to construct a frog for such a place that will permit the trolley wheels to roll across taking current from the same continuously. There will have to be a break in the continuity of the circuit at the frog for a certain length of time. This break means the going out of the lights every time the car passes such a frog. With the single wire system, none of these difficulties are experienced. On large roads the cost of copper necessary for the double wire system would be so great as to be almost prohibitory. With the single trolley system, the earth being used as a return circuit, we obtain the aid of its conductivity and also that of the rails. Practice has demonstrated that with such an enormous conductive area the resistance of the return circuit can practically be considered nil. It is true that the supplementary wire of a size equal to the trolley wire is run through the earth and connected to each rail. The use of this conductor is two fold. It not only forms a good ground for each rail but it ties the whole underground system into one connected and complete metallic system. Counting the resistance of the earth as 0 it is readily seen that only one-quarter of the copper wire is necessary for the single system as for the double wire system. Hence a most decided saving is possible.

On a large system the subject of feeders always is a most important one. With the single trolley system it is only necessary to feed one-half of the circuit, whereas with the double trolley system it is necessary to feed both sides of the circuit. In this direction alone, therefore, the cost of the latter system must be four times that of the former, allowing for the same percentage of loss.

In regard to guard wires I see no reason why it is not practically as necessary to place them over a double wire system as over a single. With the current passing out over one wire down through the car, though the motors under the car, and back by the other wire, the chances of leakage are very great.

It would be very difficult to prevent leakages somewhere on such circuit. If a leakage should be established on the positive side of a motor armature on one car and on the negative of another, both of the cars and the station might be damaged. If these leakages are so liable, the danger from a foreign wire falling across either one of the trolley wires still exists. It is unfortunate, but nevertheless



less true, that arc light wires which are supposed to be thoroughly insulated from the ground leak at times sufficiently to cause damage to life and property if a telephone or telegraph wire happens to fall across them. With bare trolley wires and with the increased chances of leakage, surely the city authorities would not and ought not to permit the erection of the double trolley system without the same system of guard wires over them as is placed over the single trolley system. The expense incumbent upon the railway company in this direction therefore is equal for both systems. The danger to property in my opinion is practically equal in both systems.

I do not deny the fact that it is possible to so construct a simple double trolley system that a falling wire touching one of the trolley wires and with its other end on the ground, would deflect no current, nor would I deny that under similar conditions a man touching this fallen wire and standing upon the ground, would receive no shock. This is speculation, not fact, and I am not arguing this matter from a theoretical or a possible condition of affairs, but from the practice which teach that ordinary existing circumstances always militate against the ideal, giving as a resultant, a system materially different from what we supposed it would be.

Repeating, therefore, what I have said in regard to danger to life and property, I feel that the danger question is practically equal in both systems.

It is unnecessary for me to state to you the fact that 500 volts is not dangerous to life, since I think there is no question but what you all have taken such a potential if not higher, and I should be pleased to have any of you state, if a discussion follows this paper, whether you have taken this potential or a higher one, and the circumstances.

As to the relative expense of the two systems, leaving out the question of feeder wires, it is true that practically in every case the double trolley system would cost one-half as much more, if not twice as much as the single trolley system. It may be here stated that the expense of running the supplementary wire underground is sometimes heavy. True, it is, but the expense is largely dependent upon the street through which your track passes. If it is macadamized or paved with Belgium blocks, or with any paving stones, the expense of removal and replacement of the same would be large. Such conditions of streets, however, only exist in large cities, and here I believe it is generally conceded by friends and opponents that the double trolley system is entirely out of the question. The expense, however, would nowhere nearly equal the additional expense of the feeder wires for the double system, nor would it equal the cost of the maintenance of such a system for a year or two.

If on the other hand, I admit that it is possible, but not the best system for a small road, we are happily confronted by the fact that so far in the majority of the cases, the small roads are not where it is needed, since the telephone companies, which practically represent the only opposition to the introduction of the electric railway, have not so extensive lines in these places. It is therefore the unfortunate middle man that has to suffer. In answer to all the foregoing objections to the double trolley wire system, the statement is sometimes made that there are to-day double trolley roads operating commercially successful; and that if they can operate in one place there is no reason why they cannot be made to operate in all other places. Steam dummies are used to-day in some places; why do not railroad companies use them everywhere? There is scarcely anything impossible in this practical age of ours, and therefore I do not deny that the double trolley system could be placed anywhere that the single is placed, but I unhesitatingly state and know that it could not be placed wherever the single is placed, and prove equally as satisfactory and commercially successful. It is not a question of cost but one of expediency and practicability. The electric companies would build double systems if they could guarantee them, and the railroad companies would demand them if they had confidence in them. An unbiased thinking man is forced to adopt the single system.

History shows that the efforts of the early promoters of the electric railway were to develop a double wire system, with an over-running trolley. This has proved a signal failure. The only roads so operated to day are at Easton, Pa., Elkhart, Ind., Ithaca, N. Y., Lima, Ohio, Pittsburg, Pa., Sunbury, Pa., St. Catharines, Ont., Lancaster, Pa., Asbury Park, N. J., Appleton, Wis., and Wheeling, W. Va., eleven in all. There are none under contract, and no firm thinks for a moment of building such a system. History also shows us that the next step in progression was the development of the under-running trolley for this same double trolley wire system. Years have gone by, and we have only three companies in the whole United States having such a system in operation, these are at Cincinnati, O., Meriden, Ct., and Mansfield, O. As illustrative of the feeling and confidence the street railway profession have in this system, I find that there are about five companies who have contracted for such a system. I venture to assert at this point that if the conditions of the contracts for these roads were seen, most interesting and extraordinary clauses would be discovered.

If we now turn to the extraordinary development of the single trolley system, we find figures which truly are amazing. On July 1, 1888, the Thomson-Houston Company was not in the electric railway business, and the total number of roads in operation in the United States and Canada, put in by all the electric companies who then were doing business, viz., Sprague, Daft and Van Depoele, was thirty-three. Of these but two or three were the single wire system under-running trolley; whereas to-day there are nearly 115 roads in operation, and an equal number under contract, and of these all but some four or five have been put in or contracted for by either the Thomson-Houston Company or the Sprague Company. Two hundred and thirty roads contract for the single system, five for the double. If I take the history of the Thomson-Houston Company since it commenced to build electric railways, I will find that it has in less than two years, put sixty-one roads in

operation, and has under contract forty-five more, making a grand total of 106 roads contracted for with the single trolley system, by one company. Could there be more conclusive proof of the pre-eminent adaptability to a commercial necessity than this, for the single trolley system?

The future is destined to surpass this record as surely and as amazingly as the adoption of electric lights and telephones surpass their records of eight or ten years ago.

### Street Railway Associations.

OFFICERS, DATES OF MEETINGS, ETC.

#### AMERICAN ST. RY. ASSOCIATION.

President, Thomas Lowry,.....Minneapolis, Minn.  
 First Vice-president, C. Densmore Wyman,....New York  
 Second Vice-president, J. C. Schaffer,.....Indianapolis, Ind.  
 Third Vice-president, Robert McCulloch,....St. Louis, Mo.  
 Secretary and Treasurer, Wm. J. Richardson,....Brooklyn

#### EXECUTIVE COMMITTEE.

The President, Vice-Presidents, and  
 Geo. B. Kerper,.....Cincinnati, O.  
 Geo. W. Kiely,.....Toronto, Can.  
 R. Semmes,.....Memphis, Tenn.  
 F. H. Monks,.....Boston, Mass.  
 Francis M. Eppley,.....Orange, N. J.  
 The annual convention of the Association will be held at Hotel Iroquois, Buffalo, N. Y., commencing on Wednesday, Oct. 15, 1890.

#### N. Y. ST. RY. ASSOCIATION.

President, John N. Partridge,.....Brooklyn  
 Vice Presidents, Daniel B. Hasbrouck,.....New York  
 P. B. Brayton,.....Syracuse  
 Secretary and Treasurer, William J. Richardson, Brooklyn  
 The annual meeting of the Association will be held in Rochester on September 16, 1890.

#### MASS. ST. RY. ASSOCIATION.

President, Chas. H. Odell,.....Salem  
 Vice-Presidents, H. M. Whitney,.....Boston  
 Amos F. Breed,.....Lynn  
 F. O. Stearns,.....Swansea  
 Secretary and Treasurer, J. H. Eaton,.....Lawrence  
 Regular meeting day, first Wednesday in each month.

#### THE ST. RY. ASSOCIATION OF THE STATE OF NEW JERSEY.

President, John H. Bonn,.....Hoboken  
 Vice-President, S. S. Battin,.....Newark  
 Secretary and Treasurer, Charles V. Bamford,.....Trenton

#### EXECUTIVE COMMITTEE.

John H. Bonn,.....Hoboken  
 S. S. Battin,.....Newark  
 C. V. Bamford,.....Trenton  
 C. B. Thurston,.....Jersey City  
 John Hood,.....Camden  
 A. Q. Keasbey,.....Elizabeth

#### OHIO STATE TRAMWAY ASSOCIATION.

President, Wm. B. Hayden,.....Columbus  
 Vice-President, John N. Stewart,.....Ashtabula  
 Secretary, A. E. Lang,.....Toledo  
 Treasurer, J. B. Hanna,.....Cleveland

#### EXECUTIVE COMMITTEE.

Ross Mitchell,.....Springfield  
 The annual convention of the Association will be held in Columbus, O., on November 19, 1890.

#### WESTERN ELECTRIC RAILWAY ASSOCIATION.

President,.....T. J. Evans, Council Bluffs, Ia.  
 Vice-President,.....H. E. Teachout, Des Moines, Ia.  
 Secretary,.....W. L. Allen, Davenport, Ia.  
 Treasurer,.....W. R. Moore, Moline, Ill.

### Cable Railways—Their Defects and remedies.

(Continued from page 82.)

Cast steel, while three-fourths the weight of iron, has equal strength and is for all purposes to be preferred. We are all looking for the coming of aluminum, but till then use cast steel plates for yokes and steel rods for braces.

#### X.

##### LOCATION OF CARRYING PULLEYS.

In physical geography we have for convenience many imaginary lines, and in weights and measures many more, all accidental but for the purpose for which they are used just as convenient, but "32 feet" as a space for carrying pulleys, without regard to the speed of the cable, has no foundation in mechanics or good sense. Granted that "32" has been found suitable for a seven-mile speed, it is self-evidently far too great for a ten-mile run. The remedy is, to first determine the rate of speed you will require and then locate the pulleys upon that data.

#### XI.

##### THE LOCATION OF MANHOLES.

They have always been located in the outside half of either track or to the right on single tracks. The primary cause of this costly and dangerous location is undoubtedly to be traced

to the imagined necessity to keep within the limits of the right of way. But the position is not tenable in the light of facts, which all go to show that the people would willingly allow an outside location on general principles and because the city's division of the paving would be reduced thereby, a not inconsiderable item in forty miles of track. It is needless to say that accessibility in its broadest sense would be secured and this without danger to the life of the workman or the interruption of wheel traffic. It is estimated that the cost of labor is doubled by the effort to keep clear of the trains and swift-running cable.

#### XII.

##### DRAINAGE.

The poor drainage of cable channels is the result of too scientific calculation, and the remedy is for level grades, the catch basins should not be located at a distance greater than two hundred feet apart. This will enable you to place a drainage incline on the bottom or inside of the channel, with an independent gradient of twenty-six feet to the mile, while on inclines the judgment of the engineer will be shown to be good if the basins are not to exceed three hundred feet.

#### XIII.

##### THE SERVICE.

If popular opinion could be readily expressed it would give forth no uncertain sound while extolling the merits of the average street railway employe whose duty it might be to "drive or hold the plow." It goes without saying that their service during long days of labor is everything desirable. Many of them are well and carefully dressed; a few could improve in their *tout ensemble* by a more frequent wash and the handy use of the needle; but the power of example is fast correcting these comparatively slight errors. We have ourselves seen untidy men glance, womanlike, at the "make-up" of a particularly nice young (or old, for that matter) man, and we divined his thoughts that he would henceforth be as tidy as they. We would be glad to say as much for the passengers, but that were impossible; it is not the passenger's field day; he is on business or pleasure bent and considers public servants but worms to keep out of the way or be crushed.

First. Defects of service consist in espionage by many amateur detectives whose compensation depends upon their ability to detect. The remedy is, to make that service of fewer members and better stock.

Second, and far more important, is the classification or grades of service and the penalties which follow the stopping of the alarm clock so swiftly as to, in fact, take the breath from the body while its result takes the bread from the mouths of the loved ones for whom, above all other considerations, the faithful street railway employe trips along his monotonous way. The remedy is, to classify by years of faithful service. In this sense and for this purpose we deny that all men are free and equal. A faithful service of four or five years should form a steppe, below which the "skip" could not go, and into which those from the next rung of the ladder must always be second to the one who in that class lost his "grip."

Can the public be better served, and how? The *creme de la creme* of cable railway service consists in the continuity of service. The word "interval" is not in the vocabulary of the cable railway manager. "When does the train leave" is answered by the laconic word, "Always!" And when two hundred thousand people can be safely and economically transported in each working day, it appears unreasonable to ask for a betterment, and yet liveried sentinels, in imitation of the system in vogue in the public parks, stationed at each street intersection and the law of the road "keep to the right" rigidly enforced, would insure increased speed, safety and income.

(To be continued.)

Under a new arrangement with the Northern Pacific R. R., passengers can now leave Chicago, daily, at 5:30 p.m., via the Chicago, Milwaukee & St. Paul Ry. for Portland, Ore., via Helena and Tacoma, and arrive at Portland on the p.m. of the third day. Through sleeping car service is now established on this route between Chicago and Portland, Ore.



## LEGAL DECISIONS.

## COURTS OF LAST APPEAL.

LIABILITY OF PASSENGER FOR ATTEMPTING TO ALIGHT BEFORE STOPPAGE OF TRAIN.—*North Birmingham Street Railway company v. Calderwood*. Supreme Court of Alabama: Jan. 31, 1890. 7 South Rep. 360.

This was an action for personal injuries sustained by a passenger in attempting to alight while the train was stopped temporarily. A local ordinance required trains going west to stop only at the west side of street intersections, and going east on the east side of street intersections. At the time of the accident in question the train was brought to a stop on the east side of an intersection street for only a moment, on account of a passing obstruction and while so stopped appellee endeavored to alight therefrom. She was not seen either by the conductor or engineer and when the train was started she was thrown and injured. From a verdict for plaintiff, defendant appeals. The court say:—"The lawful stopping place was on the west side of Twentieth street. It was unlawful to stop on the east side for the purpose of allowing a passenger to alight. The contract of the defendant with the plaintiff, as a passenger on its cars, must necessarily imply an agreement to stop on the west, and not on the east side. The duties, therefore, imposed by law on the defendant's servants were materially different at the two places. At the lawful stopping place they were compelled to stop to deliver the plaintiff on receiving proper notice of her desire to stop, or show some lawful excuse for their failure to do so. This stop was required to be for a time reasonably sufficient to enable her to conveniently alight. *Railroad company v. Miles* 6 South Rep. 696. And the duty of keeping a diligent lookout rested on the engineer and the conductor to see that a premature start of the train, such as might endanger her safety, should not be negligently made. No such duties were required at a place where it was unlawful to stop for the purpose of delivering passengers, unless those in charge of the train elected to stop, in violation of the law, and thereby induce the plaintiff to alight. In such case, on being informed of her presence and desire, they would presumptively be chargeable with negligence, if they failed to stop for a time reasonably sufficient to permit a safe exit from the train. The case of *Railway v. Sistrunk*, 85 Ala. 352, 5 South Rep. 79, is distinguishable from this case on the obvious ground that the alleged variance of place there was immaterial, the duties of the defendant to the plaintiff being precisely identical at each. Contributory negligence is defensive matter, and the burden of establishing it is ordinarily cast on the defendant; but this is not a correct proposition where the plaintiff's own testimony which seeks to fix negligence on the defendant, inculcates himself also, as it tends to do in this case. *Railroad Co. v. Shearer*, 58 Ala. 672. Or, to state the proposition otherwise: "When the plaintiff shows negligence on the part of the defendant, and there is nothing to imply that plaintiff brought on the injury by his own negligence; then the burden of the proof is on the defendant to show that the plaintiff was guilty of negligence." So the second charge would have been less liable to mislead if it had been asserted that contributory negligence cannot be invoked as a defense unless it is a proximate cause, instead of the proximate cause of the injury. It need not be the sole cause, but it is sufficient if it be one of two or more concurring causes. *Sistrunk's case*, 85 Ala. 352, 5 South Rep. 79, supra. The plaintiff must be held to know the rule of stopping on the further side of the street, as prescribed by the city ordinance. "It is well established that the residents within a municipality must take notice of the ordinances, and it is frequently stated that ordinances have the force and effect of laws within the limits of the corporation." *Horr. & B. Mun. Ord.*, 158. This principle seems sound, when applied to any person within a municipality who contracts, even by implication, with reference to such ordinances, when operative as police regulations. The contract here, as we have seen, by necessary intendment was that the

delivery of the plaintiff as a passenger was to be at a regular stopping place, such as would not have violative of any existing and lawful police regulation. This devolved on her the responsibility of informing herself of what we may pronounce an every-day incident of street railway travel. *Mitchell v. Railway Co.*, 51 Mich. 236, 16 N. W. Rep. 388.

LIABILITY OF COMPANY TO COMPENSATE PROPERTY OWNERS.—*Taylor v. Bay City Street Railway Co.*; Supreme Court of Michigan, April 11, 1890. 45 N. W. Rep. 335.

This was an action in which the complainants sought to restrain the attempted construction of an extension of defendants line, without compensating them for damages to their property. The charter of defendant, after it had been accepted by it, was so amended as to require it to compensate abutting lot owners for damages arising out of the construction of its lines. The defense to the present suit rested upon the validity of that amendment. From a judgment for defendant plaintiff appeals. The court say: It is highly important that the legislature should retain the power to pass enactments for the control of these quasi public corporations suitable to the changing state of affairs. Those who claim immunity from such control must be able to point to the clear enactment of the statute establishing it. In the case at bar, no such express power can be pointed out; and it was neither necessary, essential, nor indispensable to enable the municipal corporation to carry out the objects and purposes for which it was created. It is clearly within the power of the legislature to provide that street railway corporations shall pay such damages to the owners of abutting property in front of which they construct their road as this construction will cause. It follows, therefore, that the defendant accepted its charter subject to the right of the legislature to prescribe conditions under which it might thereafter obtain the use of the street railways of the city for the construction of new lines. The act above mentioned, expressly limited the power of the council to authorize the running of the street railways in the streets of the city upon the condition of compensation to owners of the lots adjoining. The act of the legislature of 1881, revising the charter of Bay City, provided that the method of arriving at the compensation to be paid to the lot owners shall be the same as provided by the general railroad laws of the state. The defendant was subject to the above provisions in making the extension of its road now in dispute. The conclusion above reached renders it unnecessary to determine the other questions raised in the case, and we pass no opinion upon the liability of the defendant at the common law. The decree must be reversed, with the costs of both courts, and, decree entered here restraining defendant from the use of that part of its road extending on Third Street between Water and Washington streets, until it has complied with the statute requiring condemnation proceedings, but giving a reasonable time for that purpose. The other justices concurred.

SPECULATIVE DAMAGES.—*Tullman v. Metropolitan Elevated Railway Co.*; Court of Appeals of New York, April 15, 1890, 23 N. E. Rep. 1134.

This was an action for damages to abutting property by the construction of an elevated railway. It was sought to introduce in evidence for the consideration of the jury the damages resulting from loss of profits which plaintiff might have received from buildings which he would have constructed on his lots, had it not been for the construction of the road. From a judgment for plaintiff defendant appeals. The court say: As a basis for estimating the damages the lots must be taken as they are used during the time embraced in the action, and the plaintiffs recovery must be confined to the diminished rental or usable value of the lots as they were. He was in no way prevented from putting his lots to any use he wished. He had the right acting reasonably, not wantonly or rashly, to put upon them any structures which he deemed most to his advantage; and at any and at all times, until the railway company acquired as against him the

right to maintain and operate its road in Fifty-Third street, he had the right to recover the diminished rental value of his lots occasioned to them just as they were by the maintenance and operation of the road. But he could not be permitted to prove or allowed to recover such damages as he might have sustained if he had put his lots to other uses, or placed upon them other structures. Such damages would be purely speculative and contingent. Upon the trial he was permitted to prove what it would have cost to erect the dwelling houses upon the lots, and what they would have rented for after they were constructed, and also to give evidence of the amount for which they would have rented if the railroad had not been constructed; and the jury evidently took this evidence into consideration in fixing the amount of damages which they awarded the plaintiff. There can be no certainty that the plaintiff ever would have erected dwelling houses upon the lots, and there could be no certainty as to the rents which could have been obtained from them either with or without the railroad in the street, and the defendant was permitted by the rule adopted in the court below to have all the advantages which he could derive from keeping his lots substantially vacant and ready to sell as such, and at the same time to have all the advantages, without the investment of any money and without any risk, which he could have derived from their improved condition. Adequate sanction for these views is found in the following authorities: *Greene v. Railroad Company*, 12 Abb. N. C. 124; *Colrick v. Swinburne*, 105 N. Y. 503, 12 N. E. Rep. 427; *Wheelock v. Noonan*, 108 N. Y. 179., 15 N. E. rep. 67; *Hatfield v. Railroad Co.*, 33 N. J. Law 251; *Dorlan v. Railroad Co.*, 46 Pa. St. 520. The rule of damages, as thus laid down, was violated by many rulings upon the trial of action, and a new trial is therefore ordered, costs to abide the event. All concur.

CONTRIBUTORY NEGLIGENCE OF PERSONS INJURED BY STREET CARS.—*Citizens' Passenger Railway Co. v. Thomas*; Supreme Court of Pennsylvania, February 24, 1890. 19 At. Rep. 286.

The Court say:—"While plaintiff was attempting to drive across the street-car track, her carriage was struck by defendant's car, which was then going down grade. Witnesses testified that the car driver had time to stop the car after plaintiff drove on the track, had he not looked down a cross street, but it appeared that when he crossed this street no one was on the track, or offering to cross in front of him, and it was not shown that his attention was unnecessarily, or for an unreasonable time, withdrawn from the track, and the accident occurred despite his efforts to stop, though he applied the brake at once. Plaintiff knew that a car was coming and was near, having heard bells, but could not see it until she turned her horse on the track; and she testified that she then thought there was time to cross. The car was moving at the usual rate on a down grade. There was a verdict for plaintiff from which defendant appealed. The Court say:—"The plaintiff in this case concedes that if the conductor or driver of the car could not have stopped it in time to avert the accident, he was guilty of no negligence; but her contention is that if he could have done so and did not, he was negligent and she is entitled to recover. The only negligent act complained of, therefore, is that the conductor did not stop the car before the collision occurred. The plaintiff testifies that she was going down the street on one side of the track, and that her intention was to cross the track and go up the same street on the other side. The driver might well have supposed in the first instance that she was merely turning on the track in front of him. He could only discover her full intent when she had gone far enough to indicate her purpose to cross over. The testimony of witnesses who had had no knowledge or experience whatever in the handling of cars or operation of brakes, is entitled to little or no consideration on the question of whether or not the driver might have been able to stop the car in time on a descending grade. *Traction Co. v. Bernheimer*. 17 At. Rep. 477. The driver was both driver and conductor of the car, and when he was crossing De Kalb street there was no one in front of him on the track,



and no one offering to cross. Under the circumstances it was certainly no act of negligence to observe whether there were passengers desiring to board the cars at that crossing. There is no evidence that his attention was unnecessarily or for any unreasonable time, withdrawn from a view of the track, nor is there any evidence that he failed to apply the brakes promptly and energetically when the exigency arose. No witness has suggested that the driver did anything which he should not have done, or that he failed to do anything which he could have done to avert the accident. On the contrary, the proof on both sides is consistent, clear and positive that the brakes were applied at once. But assuming that the conductor by an ordinary or an extraordinary effort could have stopped his car in time to prevent the injury, a question still arises as to whether or not the plaintiff was not also guilty of negligence in attempting to cross the track in front of a moving car. The car was confined in its course to the rails. It could be turned neither to the right nor to the left. It was running at the usual rate of four or five miles an hour upon a descending grade, and could not be stopped as readily or as quickly as her horse, which was moving at a slow walk. She knew that a car was coming and was near, for she admits that she was warned by the bells, but the phaeton was curtained and the curtains were down, and she could not see the car until her horse was turned upon the track. The car, she says, was thirty feet distant, and she had no reason to think there was any risk, and that there was time to cross. She would seem to have taken the chances and assumed the risk. Assuming that it was the duty of the driver to use ordinary and reasonable efforts to stop the car, the company upon the facts of this case was, we think, only responsible, if responsible at all, for wanton neglect, of which there is not the slightest proof. The plaintiff was, without doubt, according to the testimony of her own witnesses, guilty of negligence in driving her phaeton right in front of a moving car. The testimony of the plaintiff taken with that of her own witnesses clearly convicts her of negligence, which was the principal if not the sole cause of the injury. The judgment is reversed."

**VIGILANCE OF DRIVER IN LOOKING OUT FOR PEOPLE ON TRACK.**—*Anderson v. Minneapolis Street Railway company*; Supreme Court of Minnesota, February 10, 1890. 44 N. W. Rep., 518.

This is an action to recover damages for killing a child about three years of age. No question of contributory negligence was raised. The car in question was one upon which no conductor was employed, and hence it was necessary for the driver in addition to other duties to make change for passengers and to see that all passengers paid their fare. While making change in pursuance to his duties to his employer, the accident in question occurred, and before the driver could stop the car the injury had been done. A verdict for defendant was directed, from which plaintiff appeals. The court say: "Unquestionably, so far as the public is concerned, it was the duty of the driver to sit or stand where he can have such control of his team and car as was practicable. The right of defendant to run its cars must be exercised with due regard for the rights of others, and with an appreciation of the knowledge that children as well as adults may lawfully be upon our public ways. The driver may have been doing his duty to defendant when engaged in making change for passengers at a time when he should have been watchful of the rights and careful for the safety of others, but this fact does not absolve the defendant from the charge of negligence. The duty which it and its employees owe to the public is paramount to that which each man owes to the other." Order reversed.

**EVIDENCE OF PAIN FROM PERSONAL INJURIES. IMPROPER CONDUCT OF COUNSEL:**—*Laughlin Street Railway Company of Grand Rapids*; Supreme Court of Michigan, April 11, 1890, 44 W. Rep. 1049.

From a judgment for plaintiff, defendant appeals. The court say: "This case has be-

fore been in this court, and is reported in 62 Mich. 220, 28 N. W. Rep. 873. Counsel for plaintiff was permitted by the court to read to the jury the decision of this court in the same case, upon the subject of contributory negligence. He accompanied his reading with the following statement: Here is the opinion of the supreme court upon a question of fact whether this party was guilty of negligence or not, and what I propose to show is that the supreme court of the great state of Michigan, upon the facts appearing upon the other trial, said that the testimony of the plaintiff all tended to show, at least, ordinary care, and that was all the law required; and that the very arguments my brother has made in this case is asking that the jury find what the supreme court said did not exist. These remarks of counsel, and the reading of the opinion to the jury, were highly improper. Such practice is very reprehensible. Fair and impartial verdicts cannot be obtained when such means are resorted to for the purpose of influencing the jury. A witness for plaintiff, was asked what expressions of pain were made by plaintiff more than four years after the accident. This was after the suit was commenced, and about the time it was expected to come on for trial. Under these circumstances, proof of such expressions would have been incompetent, and the court should have rejected the testimony. Judgment reversed, and new trial ordered."

**STREET RAILWAY NEWS.**

See also "New Enterprises," "Extensions," "Elections," etc.

The following data is compiled with all possible care, but the publishers, receiving news as they do, from almost every state, territory and country, cannot be held responsible for errors, as it would be wholly impossible to obtain a verification of each item received by them in time for each issue.

**ALABAMA.**

**Birmingham**—The Birmingham Elec. Co. will bond its road for \$2,500,000 for the purpose of raising funds sufficient to cover its electrical equipment.

**CONNECTICUT.**

**Danbury**—The Board of Councilmen has at last given the the Ry. Co. permission to build any extension it pleases provided it uses any good rail.

**Naugatuck**—The Naugatuck & Waterbury Tramway Co. is pushing the matter of the construction of its lines, and little doubt exists but that the road will be completed during the summer.

**New London**—A good opportunity is presented here for the construction of a street railway. It is badly needed and the citizens will be willing to make almost any reasonable concession.

**DISTRICT OF COLUMBIA.**

**Washington**—A bill has been introduced into the Senate to incorporate the Washington & Arlington Railway, and also to amend the charter of the Georgetown & Jamestown R.R.

**FLORIDA.**

**Orlando**—The Orlando Street Railway has been sold to Mr. N. Poyntz for \$1,033.60; that amount being the indebtedness of the road. We understand that the road will now be considerably improved.

**GEORGIA.**

**Athens**—The citizens here are counting on having a first class Electric road in full operation here by next fall.

**Augusta**—The Augusta Railway company of which Mr. D. V. Dyar is president has made application for a franchise for about 15 miles of right of way through the streets of Augusta.

**Macon**—The Metropolitan Electric Railway company proposes to amend its charter in order to permit it to sell lights as well as operate street railway.

**Rome**—The entire street railway system here, including that between New Rome and Rome proper, will be equipped by electricity in the immediate future.

**Savannah**—At a recent meeting of the stockholders of the Savannah Street & Rural Resort Railway, it was decided to commence the operation of the line by electricity at the earliest possible moment.

**ILLINOIS.**

**Decatur**—The Citizens Electric Street Railway company has just placed \$61,000 worth of its present bonds at par. The sale was made to Chicago parties for \$14,000; another \$14,000 worth of bonds have also been sold to Decatur parties, and with that amount realized, viz; \$75,000 the company will be in good shape to push its proposed extensions, etc.

**IOWA.**

**Atlantic**—The Harding Electric Conduit company capitalized at \$60,000 has been incorporated for the purpose of introducing a new system, of street car propulsion. The inventor of the system, Mr. Chas. M. Harding, is a resident here, and believes that his system will operate electric railways successfully and dispense with the use of the overhead wire. The officers of the company are C. M. Harding, President and R. H. Applegate, Secretary and Treasurer.

**Sioux City**—The Sioux City & Island Park Railway company has decided to adopt electricity as a motive power at once. About \$25,000 will be expended in putting the road it first class condition, and for the present the company will rent electric power from the Sioux City Street Railway company.

**KANSAS.**

**Salina**—We understand that the street car lines here have been or will be purchased by an eastern syndicate and electricity adopted as a motive power.

**KENTUCKY.**

**Louisville**—We understand that a syndicate is trying to get hold of the street railways here. The lines, which are practically under one management, are owned by the Central Passenger Railway company and the Louisville City Railway company; there being about 125 miles of track. The par value of the stock of both companies is \$1,700,000 and the stock of the Louisville City Railway company (of which Mr. H. H. Littell is virtually the general manager) is quoted at \$150 per share. The Central Passenger Railway company being quoted at \$210 per share.

**LONG ISLAND.**

**Flushing**—The Flushing & College Point Street Railway company has applied for permission to erect poles in the streets where the track is laid so that it can adopt temporarily the overhead system for the propulsion of its cars. The company states that it has made every effort to operate its road with the storage battery system but the attempt has been a complete failure, or at least so much of a failure that no dependence can be placed upon it to serve the purpose of public travel.

**MAINE.**

**Bangor**—The work of laying electric railway track to South Beaver has been commenced and it is expected that the cars will be running over the line within the next two months.

**Oldtown**—The Oldtown Electric Railway company has been accorded permission to lay tracks through the streets. When the line is completed it is expected that the trip to Bangor will be made inside of an hour.

**MASSACHUSETTS.**

**East Templeton**—The New York Construction company has notified the selectmen of the town of this place that as soon as the electric road is constructed and equipped in Gardner, they will ask for a franchise to build a road here.

**Lynn**—The Lynn Belt Line company has mortgaged its property for \$100,000 to the American Loan & Trust company for the purposes of securing the first mortgage four per cent bonds.

**Merriman**—The local capitalists here are discussing the possibility of a plan to build a horse car railway from Haverhill to West Newbury.

**Newburyport**—We understand that the Black Rocks & Salt Spring Beach Railway company will purchase all the rights, interests, privileges and franchises of the Plum Island Street Railway company.

**Salem**—The Naumkeag Railway company has obtained permission to issue bonds to the amount of \$1,000,000 to permit of an extension of its lines and the adoption of electricity as a motive power.

**Newton**—The Newton Street Railway company has contracted for several new motor cars for its new line between Waltham and West Newton.



## MICHIGAN.

**Ann Arbor**—We understand that the Ann Arbor Street Railway company will have its electric cars running by the first of September. The Sprague system has been adopted.

**Bay City**—We understand that the Bay City Belt Line company will shortly increase its capital stock to \$100,000 in order to build a loop line.

**Kalamazoo**—The Kalamazoo Street Railway companies property by reason of a mortgage of nearly \$110,000 held by the Central Trust company of New York as proceeds for the bondsmen, has passed into the control of Thornton Martin, Ewing Winslow and Walter Stanton for \$2,550. It is likely that electricity will be adopted in the near future.

## MISSOURI.

**Kansas City**—The stockholders of the Kansas City & Independence Street Railway company has decided to increase its capital stock from \$100,000 to \$400,000 for the purpose of constructing a motor line from the end of Independence Avenue Cable Road to Independence, Mo.

**St. Joseph**—Mr. Thomas Corrigan of Kansas City was recently here, and we understand that the object of his visit was to try and purchase controlling interest in the People's Street Railway lines, and may be in future a general consolidation of the Street Railway interests here.

## NEBRASKA.

**Beatrice**—An electric motor line is to be built here in the immediate future; it being understood that the line is to be in operation within 60 days.

## NEW HAMPSHIRE.

**Manchester**—The annual meeting of the Manchester Horse Railway company was held last month. The report of the Treasurer showed that up to September 30th, 1889, the total receipts for the 12 months preceding were \$46,873.14 of which \$43,734.87 was from passenger fares. Total expense of the 12 months was \$47,441.90 of which \$18,135.75 was in wages. Deficiency during the year \$586.86. Interest bearing debt is now \$41,481, while the year before it was \$43,829.52. After some discussion as to the method of keeping books so as to show a full trial balance, the treasurer's report was accepted.

As the annual report of the corporation to the railroad commissioners must hereafter be made the first of July it was voted, after considerable discussion, to change the time of annual meeting from the third Saturday in May to first Saturday in September at the call of the clerk, at such place as the directors may decide upon.

President Williams stated for the benefit of the stockholders that during the seven months of the new administration there had been an increase of 60,400 in the number of passengers carried over the seven months previous. Daily expenses of the road, as figured out by Treasurer Bartlett, were now about \$50 and the president said there had been an increase of some \$20 a day in receipts. Some new eight seat cars have been ordered and are now on the way. Number of horses now kept is 139.

## NEW JERSEY.

**Atlantic City**—The fare on the Atlantic City Electric Railway has been reduced to five cents.

**Elizabeth**—We understand that a syndicate composed of New York, Elizabeth and Brooklyn gentlemen, is endeavoring to secure a franchise for the construction and operation of an electric railway in the northern part of the city. There are already three other companies in the field endeavoring to occupy the same territory and operate by horses.

A franchise has been granted to the Union County Street Railway company to build lines through the north-west and south sections of the city connecting with the parent line on Broad Street and uniting the routes so that most every part of the city will be traversed by street cars.

The Union County company is under the control of the gentlemen owning the majority of the stock of the Elizabeth & Newark line and the Newark Street Railways.

**Jersey City**—The Jersey City & Bergen Street Railroad company has arranged with the Jersey City Electric Light company for a supply of power with which to operate its electric cars on Montgomery Street.

**Newark**—The Essex Passenger Railway company has abolished the eight cent fare between

Newark and Orange, and extended the distance for the five-cent fare between Maple Avenue and Newark, and Rosedale and Orange.

The tracks of the Rapid Transit Railway company have closed with the Sprague company for the construction of its over-head wire system. The Sprague company agree to have the line finished on Washington Street and Belmont Avenue in July, and if the cars are ready as expected, it will probably be in operation by the first of Aug.

**Sandersville**—It is highly probable that an electric street railway will be built here in the immediate future.

**Trenton**—The Trenton Horse Railway company recently had a judgment rendered against it in favor of Holden N. J. for the sum of \$5,000 by reason of the plaintiff having sustained injury in October, 1887 by being run over by one of the companies cars and crippled for life.

## NEW YORK.

**New York City**—An ordinance has been passed by the Board of Aldermen compelling all the surface roads of the city to operate night cars at twenty minutes headway between the hours of midnight and six o'clock A. M. A penalty of \$100 to be made for each violation.

**Albany**—News reaches us that the Albany Railway company is about to introduce a fire wagon which will be ready day and night to promptly respond to fire alarms on any one of the streets through which the company's tracks pass. Two men will have charge of the same, and it will be their duty to attend to the cutting of the company's wires, etc., so that the firemen may not be hindered in their work, and also to see that no one may suffer from accidental shocks,

**Bellston**—The trustees of the village of Bellston have decided to give the Electrical Railway company the right to enter the village from Saratoga.

**Buffalo**—We understand that all the existing street railways here have been sold to a syndicate consisting of Murray Verney of Pittsburg, M. Silas McKee, Paton & Co. and T. Dewitt Coyer. It is said that the purchase price is about \$3,000,000 on which two payments have already been made; one of \$5,000 as an option and the other of \$100,000 to close the deal. We understand that the transfer is to be completed during the present month.

Work on the new Crosstown Street Railway will be commenced at once.

The recent elections of officers of both the Buffalo West Side and the Buffalo East Side Street Railways has we understand, no bearing on the future of the companies, as it is merely the annual election required by the charter of the companies, and are made simply to comply with the law. In about a couple of months a special election will be held when the new owners will probably take charge of the road.

**Glen Falls**—Wm. C. Munder, Jr. & Co. of New York City have leased the advertising privileges for a term of years of the Glen Falls, Sandhill and Fort Edwards Street Railway company. The road is carrying at present in the neighborhood about 1,000 passengers daily.

**Huntington**—The Huntington Railway company, capitalized at \$30,000, has been incorporated for the purpose of constructing and operating a three-mile surface railroad in this place. The principal stockholders are Geo. A. Drake, of Morristown; J. C. Saxton, of Bloomfield, N. J.

**Little Falls**—The directors of the Little Falls & Van Horne's Street Railway will probably use electricity as a motive power, there being ample water power at the Falls and Van Horne's Valley to operate the road.

**Lyons**—The Lyons Street Surface Railway company has been authorized to issue bonds to the amount of \$30,000.

**Suspension Bridge**—The Niagara Falls and Suspension Bridge Street Railway company has been sold to a Buffalo company, which had before organized a company to build an electric railroad from Buffalo to the Falls. A list of the directors will be found under the head of Elections, in the present issue. We understand that \$1.40 per share was paid for the stock.

**Syracuse**—The Eleventh Ward Street Railway company has leased all of its rights and property to the Seventh Ward Street Railway company for a term of years for the corporate

existence of both companies. The lessee is to pay the bonds which the lessor issued about June 1st, 1889, amounting to \$25,000, and is to pay to the holders of the same the same dividends it pays to shareholders of the same company.

Articles of concession to the Syracuse Consolidated Street Railway company have been filed. The length of the line is about forty miles and the capital \$1,250,000, divided into \$100 shares. A list of the directors will be found under the head of Elections, in the present issue.

**Tonawanda**—The Buffalo, Tonawanda & Niagara River Railroad company, mention of which was made in the May number of the GAZETTE, has made application for a franchise to build a street railway. Mr. S. B. Hard is president of the company.

**Watertown**—Two or three times parties have made an effort to promote the construction and operation of an electric railway here, and each time they have failed of success. It looks as though Watertown is doomed to be behind other cities of the same size, at least so far as rapid transit is concerned.

## OHIO.

**Sandusky**—C. W. Foote, of Cleveland, Christie Bros. of Akron, and C. E. Cook, of Chicago, have bought the street railway here and will probably adopt the Sprague system of electrical propulsion.

**Toledo**—The Toledo Electrical Street Railway company has increased its capital stock from \$500,000 to \$600,000.

## PENNSYLVANIA.

**Greensburg**—The Greensburg & Hempfield Electrical Street Railway company has awarded the contract for the construction of its road to F. Y. Clapper, who will commence work at once and push it through to completion.

**Kingston**—The West Side Electrical Railway company will increase its capital stock at once for the purpose of providing for important extensions.

**Lancaster**—Two street railway companies here have been purchased by a syndicate represented by J. E. Ackley, Knight, Nefel & Sumner T. Dunham, all of New York, who will operate the system by electricity.

**Norristown**—We understand that the majority of stockholders of the Citizens' Passenger Railway company have signed an agreement to dispose of their stock to outside parties, who have been negotiating for the same.

**Philadelphia**—The Frankfort and Southwalk Passenger Railway company will issue 5,000 additional shares of stock, valued at \$25,000, the proceeds from the sale of which will be used for extensions on Fourth street and Lehigh avenue and the general improvement of the line.

**Pittsburg**—The Pittsburg, Mountell & Homestead Street Railway company has applied for the right of way through Homestead.

Last month one of the cars of the Pleasant Valley Electric Railroad company got away from the Motorner and went bowling down the hill with lighting like speed. Owing to the cool-headedness of one E. A. Maxwell of Allegheny, what would have been a terrible accident accompanied with considerable loss of life was averted. As soon as he saw what had happened he made for the front platform, grabbed the motorner and threw him inside of the car; he then took hold of the brake and gave it a wrench that made the fire fly from the wheels. By sheer force of strength and scientific manipulation of the brake, Mr. Maxwell succeeded in getting the speed of the car slackened down, a bit to permit another car to pass a curve, but when the runaway car struck the curve, the shock was so tremendous that Mr. Maxwell was flung off the car and sustained a fracture of the left ankle and dislocation of the leg at the hip, and what may possibly prove to be some very severe internal injuries. It is claimed that the regular motorner made a statement at the top of the hill that the brake was out of order, and would not work and declined on that ground to take the car down the grade, but one of the employes however thought he could do it without any trouble, and by his fool-heartedness came very near causing the loss of eight or ten lives.

News reaches us from this point that the Squirrel Hill Electric Railway company, the



construction of which has about approached completion, will probably be sold by the sheriff to satisfy judgments which have been obtained against the company amounting to somewhere near \$30,000. \$14,000 is due to McKippen & Watts, contractors; about \$8,000 to M. G. Frank & Co., and \$8,000 is due partly to the Gilbert Car Co. of Troy and Johnson Co. of Johnstown, Pa. The company to build the line was incorporated and charter granted about three years ago. The incorporators were A. Murdock, Howard Morton, George Morris, Robert Britton and Joseph Loughrey. Work on the construction of the road was commenced February a year ago. The route of the road is from Forbes and Bates streets, Oakland to Homewood Avenue, near the Homewood cemetery, a distance of about three miles. The road has been completed, all the grading being done rails laid, etc., with the exception of a small piece of trestle work in Oakland. The total cost of the railroad so far has been \$80,000, of which \$50,000 has been paid. The reason work was stopped and judgment allowed to be entered was dissensions among the stockholders and directors.

The directors of the Pittsburg and Birmingham road recently met at the Duquesne Hotel and let the balance of the contracts for the electric road. It was not decided what system of electric traction would be adopted, but it is very likely that the newly organized Westinghouse Electric Railway company will be given an opportunity of testing their system there. Contract for the cars has not been let, but the Gilbert Car Manufacturing company of Troy will probably secure the order. There will be thirty cars in all, each of which is to be thirty feet in length. The Standard Underground Cable company has secured the contract to furnish all the roads belonging to the Murray-Vernar syndicate with insulated wire.

**Pittston**—It is said Isaac E. Le Barr will organize a company to buy the Pittston Street Railway plant and operate it by electricity.

**Wilkes Barre**—The Wilkes Barre & West End Electric company will soon have its line in operation.

#### RHODE ISLAND.

**Pawtucket**—A petition for a charter for the Pawtucket Electric Railway company which was to go before the General Assembly at the May session was heard before the committee of Corporators, but by reason of a technicality in the proposed charter, the matter was continued until next session.

#### SOUTH CAROLINA.

**Charlestown**—The Enterprise Street Railway company will adopt electricity at once.

#### TENNESSEE.

**Knoxville**—The Fountain Dummy Line Railroad company has completed its line. Cars are in daily operation.

**Memphis**—Mr. C. B. Holmes, the head of the Chicago syndicate which recently bought the Memphis Street car lines, was recently here, and it is the intention of the syndicate to introduce electricity as a motive power at an early date. The estimated cost of the change will be in the neighborhood of three quarters of a million dollars.

#### TEXAS.

**Rusk**—Col. W. H. Spaulding manager of the Rusk Street Railroad company was recently thrown from the car and quite seriously injured.

#### VIRGINIA.

**Berkeley**—We understand that the street railway company here will abandon operation of its line and tear its track up if the council compels them to pay a car license of \$25.

**Lynchburg**—The West Lynchburg Land company has bought the street railway here at \$25 per share of 475 shares, and it is to pay a mortgage amounting to \$11,000.

**Richmond**—The Riverview Improvement company has instituted suit against the Richmond Union Passenger Railway company for \$100,000. It is claimed by the plaintiff that it has sustained that amount of damages by reason of the failure of the Street Railway company to extend its tracks in certain directions which, it is alleged, the company agreed to do on the first of March.

#### WASHINGTON.

**Tacoma**—Articles of incorporation of Hillihust Spanaway and American Pneumatic Railway company of this city have been filed. The company

proposes to buy, own, construct, equip, maintain, operate, mortgage lease, and otherwise acquire the adoption of steam, horse, electric, pneumatic cable and other railway, telegraph and telephone lines. The capital stock of the company is \$50,000, and a list of the trustees will be found under the head of elections of the present issue.

#### WISCONSIN.

**Merri**—Mr. M. K. Gochnaur of Appleton has secured the contract to build the recently projected street railway here.

## NEW ENTERPRISES.

#### ALABAMA.

**Oxford**—Dr. C. Herndon and others have received a 25-year franchise to build and maintain street railways in this place.

#### ARKANSAS.

**Sarcey**—The Citizens' Street Railway company of this place has been incorporated with a capital stock of \$25,000. The incorporators are J. M. Battle, T. H. Henderson, Otho King, S. Perry, T. A. Yarnall and Z. E. Kerr.

#### CONNECTICUT.

**Willard**—The Milford & Hopedale Street Railway company, capitalized at \$60,000, has been organized. A list of the officers and directors will be found under the head of Elections in this issue.

#### FLORIDA.

**Jacksonville**—The Jacksonville & Suburban Street Railway company has been organized, and when the projected road is built it will be operated by electricity.

#### GEORGIA.

**McBelton**—The McBelton Street Railway company of this city, capitalized at \$100,000, has been organized for the purpose of building and operating a street railway line here.

**Sandersville**—A project is on foot to build an electric railway from this point to Tennesse.

#### ILLINOIS.

**Chicago**—The Chicago Arcade Rapid Transit capitalized at \$8,000,000, has been incorporated for the purpose of constructing a line of road from a point on Fifth avenue, between Harrison and Madison streets, with a branch on Milwaukee and North avenues, to the present or future city limits. The incorporators are E. Louis Kuhns, H. A. Ritter, A. F. Shuman, Percy L. Shuman and Joseph H. Defrees, all of Chicago.

The Southwestern Street Railway company, capitalized at \$100,000, has been incorporated for the purpose of constructing and maintaining a horse-dummy cable railroad within the city of Chicago. The incorporators are Christian E. Wiehe, Thos. J. Greiger and John Gavin.

#### INDIANA.

**Go'lumbus**—The city council has granted a franchise for a line of street railway to John S. Crump. The line is about four miles in length and to be in operation by the first of October. The motive power at the start will be animal, after which electricity will undoubtedly be adopted.

#### KANSAS.

**Atchison**—The Atchison Electric Street Railway company of this city has been incorporated, with a capital stock of \$400,000. A list of the directors will be found under the head of Elections, in the present issue.

#### MAINE.

**Brewer**—An electric railway is to be built here at once.

#### MARYLAND.

**Baltimore**—The Baltimore and Pikesville Electric Railway company capitalized at \$100,000 in \$2,000 shares at \$50 each, has been incorporated by Geo. W. Webb, B. H. Swayne, Erein E. Reinhardt, Chas. G. Hill, Geo. G. McGaw and Robert McGruder. It is proposed to construct and operate the road from the intersection of North Avenue and the Reistertown road and Pikesville with such branches as business may warrant. It is also probable that the line may be extended into Greenspring Valley.

#### MASSACHUSETTS.

**Abington**—A movement is on foot in which Judge Kelly of this place is prominently interested to organize an electric railway company. It is proposed to capitalize the company at \$100,000.

**Newton**—Col. Hewitt (the Union Electric Car company) and Hon. Mr. Awley of Lynn, J. H. Nickerson of West Newton, A. R. Mitchell, and W. H. Mendan of Newtonville, and Albert Plumber of Aubondale have petitioned for an Electric Railway franchise for the right of way between Newtonville to Newton Islands; thence to Newton Centre, and back to Newtonville. Capital stock of the company is \$40,000, and it is understood that the storage battery system will be used.

The Newton Central Street Railway company has been organized with a capital stock of \$30,000, the bulk of which has been taken by a gentleman prominently interested in the Newton Street Railway company. The line will be constructed at once and the overhead system will probably be adopted.

**Orange**—G. W. Dunham and other New York capitalists have been granted a franchise for an electric road between Orange and Uthol. Work will be commenced at once and the Daft double trolley system will be used.

**Worcester**—It is highly probable that a line to Lakeview will be built here by the Consolidated Street Railway company.

#### MONTANA.

**Butte**—The Silver Bow Electric Railway company capitalized at \$200,000 has been incorporated for the purpose of building a line four miles in length from the city to Silver Bow Park, Columbia Gardens to the race track. A list of the Trustees will be found under the head of elections in the present issue.

#### NEW HAMPSHIRE.

**Dover**—A survey will be made for an electric road from this road to Great Falls.

#### MISSOURI.

**Joplin**—The Joplin Rapid Transit company has been granted the right of way along the principal streets of the city for an electric railway line, to be constructed under the patents of the T-H company.

The capital stock of the Joplin Belt Line company is \$150,000 and a list of the officers will be found under the head of elections in the present issue.

#### NEW JERSEY.

**Newark**—L. T. Fell, C. A. Lighthouse, Thomas A. Nevins, Thomas Nevins of Orange, F. W. Ward and W. H. H. James of East Orange and Charles W. Truslow of Summit are the incorporators of the Suburban Railway company, which has just filed its papers with the secretary of state at Trenton. It is the intention of the company to get the right of way from the Newark line on Central avenue, through East Orange, Orange and West Orange to the Valley road. What kind of a cars or power it will use is unknown. The capital stock is quoted at \$100,000.

**Rahway**—We understand that the Fidelity Syndicate is working hard get permission to run horse car tracks through the city. It is estimated that something in the neighborhood of \$30,000 will be expended in the project.

**Somerville**—A company has been formed here for the purpose of operating a horse car line in this place; the capital stock of the company is to be \$20,000, and the incorporators of the same are as follows: Major Samuel Klotz of Newark, W. J. Keyes of New York, Hon. A. A. Clark, Senator L. A. Thompson, Assemblyman Klotz, Joseph W. Ballantine, Captain G. S. Cook of Somerville, and Hon. L. H. Trimmer, assemblyman from Hunterdon county.

#### OHIO.

**Covington**—The Florence & Covington St. Ry. Co. has been incorporated.

#### PENNSYLVANIA.

**Allegheny**—The Perry St. Ry. Co. of this city has been chartered with a capital of \$100,000 for the purpose of constructing and operating a street railway here by electric or cable system. A list of the Directors will be found under the head of elections in the present issue.

**Butler**—The Butler Traction Co. of this place, capitalized at \$18,000, has been chartered. Among the projectors of the scheme are John S. Craig, Theo. Sproull, Allegheny; W. F. Lloyd, Andrew and W. J. Crawford, Pittsburg; G. Williams, J. H. Sutton and David Osborne, of Butler. It is the intention of the company to build a street railway in the borough at once.



**Coraopolis**—The Neivee Island R. R. Co. of this place has been chartered with a capital of \$100,000.

**Greensburg**—We understand that the Directors of the Elec. St. Ry. Co. here have decided to adopt the Westinghouse Elec. system.

**Huntington**—A project is on foot for the construction of a St. Ry. here.

**Philadelphia**—The Walnut St. Pass. Ry. Co. capitalized at \$25,000 has been chartered.

**Pittsburg**—The Hilltop Traction St. Ry. Co. of this city has been chartered with a capital stock of \$8,000.

The Allegheny & Belleview St. Ry., Co., capitalized at \$6,000, has been chartered. A list of directors will be found under the head of Elections in this issue.

The Belleview & Allegheny St. Car Co. has received permission from the council to operate its line by either electricity or cable. The company has pledged itself to lay double track of standard gauge and to commence work after two months of the passage of the ordinance and have the line completed within six months from that time.

**Tarantum**—The Tarantum Traction Pass. Ry. capitalized at \$50,000 has been chartered. A list of the directors will be found under the head of elections in the present issue.

#### RHODE ISLAND.

**Franklin**—A project is on foot for the construction of an electric railway at this point.

#### SOUTH CAROLINA.

**Greenville**—It is more than likely that an electric railway will be built here in the immediate future.

#### TENNESSEE.

**Bristol**—Work on the line of the Bristol Belt R. R. Co. will be commenced within about 30 days, and the completion of one mile of track is guaranteed within one year.

#### TEXAS.

**Seymour**—The Seymour St. Ry. Co. of Baylor Co. capitalized at \$25,000 has been incorporated by L. T. Wilson, M. Davis, W. E. DePree and J. N. Morris.

## EXTENSIONS.

**Augusta, Ga.**—The new Electric R. R. Co. has obtained permission to lay 25 miles of track instead of 16 miles.

**Beverly, Mass.**—The Beverly & Danvers St. Ry. Co. has decided to extend its road considerably in the near future.

**Binghampton, N. Y.**—The electric road is being extended to the Susquehane Valley Hall and will be in working order in a short time.

**Decatur, Ill.**—The Citizens St. Ry. Co. will extend its line at once; the necessary funds for the same having been raised by the sale of bonds.

**Duluth, Minn.**—The Directors of the Minnesota Point St. Ry. Co. have decided to extend its line about one and three-quarters miles at once.

**Fitchburg, Mass.**—The Fitchburg Ry. Co. contemplates making some important extensions at once.

**Framingham, Mass.**—The Framingham St. Ry. Co. proposes to extend its track to the Lakeview Camp ground.

**Kingston, Pa.**—The West Side St. Ry. Co. will extend its road at once.

**Laconia, N. H.**—The Laconia & Lake Village Horse R. R. Co. will be extended about a half mile at once.

**Lynchburg, Va.**—The St. Ry. here is to be extended at once.

**Newark, N. J.**—The Newark & Arlington R. R. is to be extended a mile or so directly after the electric equipment is completed.

**Newburyport, Mass.**—The Horse R. R. is to be extended from this point to Seabrook, N. H. during the summer.

**Newton, Mass.**—It is highly probable that the St. Ry. here will be extended considerably in the immediate future.

**Orlando, Fla.**—The Orlando St. Ry. Co. which recently passed into the control of Mr. Pointz will be extended at once.

**Philadelphia, Pa.**—The Peoples Line will be extended from its present terminus, Airy to Wissasakia Ave. to Chestnut Hill, a

distance of about 2½ miles. It is probable that electric cars will be used. These extensions will make direct connection between Germantown, Chestnut Hill and the city.

**Frankfort, Pa.**—The Frankfort & South Walk Pass. Ry. Co. will extend its line on the 4th St. and Lehigh Ave. at once.

**Quincy, Mass.**—The Elec. Ry. is being extended from the Depot to West Quincy.

**Salt Lake City, Utah.**—The Rapid Transit Co. has been accorded permission to extend its line some 5 miles.

**Seattle, W. T.**—The extension of the Madison St. Cable line is being pushed rapidly and the road will probably be open to Lake Washington by the middle of this month.

**Waterville, Me.**—It is highly probable that the Horse Ry. service will be extended here quite considerably in the near future.

## ELECTIONS.

**Alleghany, Pa.**—The Directors of the recently chartered Perry St. Ry. Co. are as follows:

D. E. Henry, S. C. Grier, Wm. T. Lindsay, Wm. A. Stone, Wm. H. Graham.

**Atchison, Kas.**—The Board of Directors of the Atchison Elec. St. Ry. Co. consists of the following named gentlemen: W. W. Hetherington, George Storch, W. L. C. Allis, Atchison; G. H. Williams, H. J. Fansom, Alex. Hastie, W. H. McConaughy.

**Beverly, Mass.**—At the annual meeting of the Beverly & Danvers St. Ry. Co. which was held on the afternoon of the 3d inst., the following named gentlemen were elected as officers, etc.:

Treas.—P. E. Clark.

Clerk—John S. Baker.

Directors—John S. Baker, P. E. Clark, Sam'l. J. Foster, S. W. Winslow, S. W. Wilson, Perry Colier, Calvin Putnam, Gilbert A. Templin and H. W. Foster.

**Bridgeport, Conn.**—At a recent annual meeting of the Horse R. R. Co. the following named gentlemen were elected as officers and directors for the current year:

Prest.—F. D. Baker.

Secy. & Treas.—Geo. O. Lines.

Directors—F. D. Baker, Geo. O. Lines and Mrs. Sarah Beardsley.

**Boston, Mass.**—At the annual meeting of the Onset Bay, Independence St. Ry. Co. the following named gentlemen were elected as officers and directors for the ensuing year:

President—Thos. B. Griffith.

Treas. and Supt.—Isaac B. Eldridge.

Directors—A. W. Wilcox, Wm. F. Nye, Hardy Smith, Kies Doane, Benj. F. Caswell, Charles McDermott.

**Buffalo, N. Y.**—The annual election of the Buffalo Street Ry. Cos. was held in Buffalo on the 3d inst. with the following result:

Prest.—H. M. Watson.

Secy.—S. S. Spaulding.

Treas.—Jos S. Baecher.

Directors—H. M. Watson, S. S. Spaulding, E. G. Spaulding, Porter Norton, Jos. S. Baecher. The Buffalo East Side St. Ry. elected the following:

Prest.—S. S. Spaulding.

Secy.—H. M. Watson.

Treas.—Jos. S. Baecher.

Directors—S. S. Spaulding, E. G. Spaulding, H. M. Watson, Porter Norton and Jos S. Baecher. **Butte, Mont.**—The following named gentlemen constitute the Board of Trustees of the recently incorporated Silver Bow Co.: J. W. Lawrence of Helena; J. W. Fairfield, O. Height, Paul Davis, J. H. McMonagle, J. D. Thomas of Butte, Mont.

**Canandaigua, N. Y.**—At a recent meeting of the stockholders of the St. Ry. Co. here, the following named gentlemen were duly elected for the current year.

Prest.—F. O. Chamberlain.

Vice Prest.—C. N. Andrews.

Secy.—C. F. Milliken.

Treas.—A. S. Cooley.

Mgr. & Director—C. C. Sackett.

Directors—F. O. Chamberlain, A. S. Cooley, C. C. Sackett, L. M. Clement, C. F. Milliken, C. J. Andrews, C. A. Waldron.

**Chicago, Ill.**—The first Board of Directors of the Chicago Arcade Rapid Transit Co. consists of the following named gentlemen:

E. Louis Kuhns, H. A. Ritter, A. F. Shuman, Percy L. Shuman and Jos. H. Defrees, all of Chicago.

**Dover, N. H.**—At a recent annual meeting of the Dover Horse R. R. Co. which was held on May 26th the following named gentlemen were duly elected as directors for the current year:

Edward B. Shaw of Newburyport, Willard B. Ferguson of Danbury, Frank A. Christie, Isaac F. Abbott, William D. Sawyer, Charles S. Cartlens of Dover, Henry W. Burgett, Brookline.

**Duluth, Minn.**—At the annual meeting of the Minnesota Point St. Ry. Co., the following named gentlemen were elected as officers and directors for the current year:

Prest.—J. J. Hibarth.

Vice Prest.—J. H. Bell.

Treas.—B. Silverstein.

Secy.—Wallace Warner.

Supt.—Walter Murray.

Directors—Walter Hibarth, J. J. Bell, W. P. Harrison, B. Silverstein, Wallace Warner, Walter Murray.

**Flushing, L. I.**—The officers of the Flushing & College Point St. Ry. Co. are as follows:

Prest.—Jos. Dikes.

Secy.—C. Frey.

Treas.—Henry Clement.

Directors—David Master, A. K. P. Benet, John Henderson, John Hepburn, Thos. Elliott, C. Platt Stratton.

**Fort Worth, Tex.**—At the annual meeting of the Fort Worth Land St. Ry. Co. the following named gentlemen were elected as officers for the ensuing year:

Prest.—T. J. Hurley.

Vice Prest. & Treas.—Geo. L. Hurley.

Secy.—Willis H. Post.

Supt.—W. B. Quitt.

**Kansas City, Mo.**—The Kansas City Cable Co. at a recent meeting re-elected the old Board of Directors.

**Joplin, Mo.**—The directors of the Joplin Belt Line Railway company have elected the following officers:

President—S. C. Henderson.

First Vice-President—W. H. Picher.

Second-Vice President—D. C. McConey.

Secretary—W. B. McIntire.

**Manchester, N. H.**—At the recent annual meeting of the stockholders of the Manchester Railway company the following named gentlemen were elected:

President—Gen. Chas. Williams.

Treasurer—Chas. H. Bartlett.

Clerk—Edwin F. Jones.

Directors—Gen. Charles Williams, Hon. A. P. Olzendam, Hon. James F. Briggs, Hon. Charles H. Bartlett and Joseph L. Stevens.

**Milford, Conn.**—At a meeting of the recently organized Milford & Hopedale Street Railway company the following named gentlemen were elected as officers and directors for the ensuing year:

President—E. P. Usher.

Secretary—P. W. Morse,

Directors—E. P. Usher, F. W. Morse, F. W. Draper.

**Nashua, N. H.**—At the recent meeting of the stockholders of the Nashua Street Railway company the following named gentlemen were duly elected as officers for the current year:

President—J. H. Knowles.

Vice President—J. F. Fisher.

Clerk and Treasurer—John G. Chandler.

Directors—George H. Knowles, Charles Williams, John Fisher, W. H. Knowles, John D. Chandler.

**Natick, Mass.**—At the annual meeting of the stockholders of the Natick & Cochituate Street Railway company the following named gentlemen were duly elected as officers and directors for the current year:

President—Harrison Harwood.

Treasurer—Wm. H. Bent.

Directors—Harrison Harwood, Frank Hayes, Charles Pooke, John O. Wilson, Wm. H. Bent.

**Pittsburg, Pa.**—The following named gentlemen constitute the board of directors of the Allegheny & Belleview Street Railway company recently chartered: L. H. Mathews, M. C. McFeen, Wm. T. Lindsay, M. R. Sewall, Wm. Beal, C. W. Robinson.



**Savannah, Ga.**—At a meeting of the incorporators of the Enterprise Street Railway company, the following named gentlemen were duly elected as officers, etc., for the current year:

President—W. B. Stillwell.

Vice-President—D. G. Purce.

Treasurer—E. F. Bryan.

Secretary—A. McDuncan.

Directors—W. B. Stillwell, J. C. Roland, D. G. Purce, S. Hamilton, T. F. Johnson, A. McDuncan and E. F. Bryan.

**Suspension Bridge, N. Y.**—The new board of directors of Niagara Falls & Suspension Bridge Street Railroad company are as follows: Each of the gentlemen named come from Buffalo: Charles G. Curtiss, Charles A. Sweet, John Satterfield, Adelbert Moot, William H. Johnson, Haskell L. Taylor, Charles B. Hill and George L. Lewis.

**Syracuse, N. Y.**—At a recent meeting of the stockholders of the Consolidated Street Railway company the following named gentlemen were elected as officers of the company for the current year:

President—John Dunn, Jr.

Vice-President—Hamilton S. White.

Secretary—Major Theo. L. Poole.

Treasurer—F. C. Eddy.

Directors—Simon Wormser, Casimir Tag, Lathrop R. Bacon, New York; Clarence H. Wildes, Riverdale; John Dunn, Jr., Louis Marshall, Manning Palmer and Hamilton S. White, of Syracuse.

**Tacoma, Washington**—The following named gentlemen constitute the board of trustees of the recently incorporated Hillhurst, Spanaway & American Lake Pneumatic Railway company: Wm. S. Taylor, Penwick W. Taylor, Harry G. Martin.

**Tarantum, Pa.**—The board of trustees of the Tarantum Traction Passenger Railway company are as follows: Jas. E. Lane and David A. Leslie, of Parnassus; George E. Grier, James W. Grier, Chas. E. Bostwick and James A. Terpe, of Dubois; John C. Grier, of Punxsutawney; David O. Hutchinson, of Pittsburg; Worthy A. Dumbrell, of Allegheny City; Samuel Lauck, of Driftwood; Charles E. Shoop, of Franklin, and John M. Morrison, of Logan's Ferry.

**Traverse City, Mich.**—The Traverse City Railway company has elected the following named gentlemen as officers and directors for the current year:

President—Hon. Perry Hannah.

Secretary and Treasurer—J. H. Hugart.

Directors—Perry Hannah, Smith Barnes, W. H. S. Michell, Thos. B. Bates, D. C. Leach, W. P. Shelby, A. W. A. Hughart.

**Wilmington, Del.**—At a recent meeting of electors of the Front & Union Streets Railway company the old officers were re-elected.

### Patents.

The following is a list of such patents as relate to street railway interests, issued during the month of April, especially prepared for the STREET RAILWAY GAZETTE by Higdon & Higdon, Solicitors of Patents, LeDriot Bldg., opposite U. S. Patent Office, Washington, D. C. A printed copy of any patent here named will be furnished by them for 25 cents (stamps).

#### Issue of March 18, 1890.

423,871. Street Railway, W. L. Judson, Minneapolis, Minn.

423,872. W. L. Judson, Minneapolis, Minn.

423,874. Means for Supplying Electricity to

Tram-Cars, A. L. Lineff, Chiswick, England.

424,436. Fare Register, Meaker Manufacturing Co., Chicago, Ill.

423,803. Cable-Gripping Mechanism, T. Obach, Vienna, Austria-Hungary.

423,440. Cable Railway Apparatus, L. Parker, Davenport, Iowa.

423,495. Crossing for Electric Conductors, Short Electric Railway Co., Cleveland, O.

#### Issue of March 25, 1890.

423,897. Constant Current Motor, W. Baxter, Jr. Baltimore, Md.

424,269. Street Railway Car Truck, W. M. Cary, San Francisco, Cal.

423,909. Regulator for Dynamos, H. W. Cooley, Boston, Mass.

424,406. Commutator, W. F. D. Crane, Philadelphia, Pa.

423,912. Commutator Brush, P. Diehl, Elizabeth, N. J.

423,991. Dynamo-Electric Machine, S. Z. Ferranti, Hampstead, England.

424,110. Coupling for Trolley Wires, T. L. Johnson, Cleveland, Ohio.

424,298. Electric Railway, J. C. Henry, Kansas City, Mo.

424,206. Electric Railway Car, R. M. Hunter, Philadelphia, Pa.

424,207. Electrically-Propelled Vehicle, R. M. Hunter, Philadelphia, Pa.

424,065. Dynamo-Electric Machine, C. D. Jenney, Indianapolis, Ind.

424,070. Electric Locomotive, G. W. Mansfield, Boston, Mass.

424,340. Electric Railway, J. F. McLaughlin, Philadelphia, Pa.

424,364. Electric Railway, E. P. Slentz, Idlewood, and J. D. McGrew, Pittsburg, Pa.

424,371. Removable Truck for Electric Cars, J. Stephenson, New York, N. Y.

424,372. Electric Car Truck, John Stephenson, New York, N. Y.

424,373. Electric Car Truck Frame, J. Stephenson, New York, N. Y.

424,374. Trolley Bridge, J. Stephenson, New York, N. Y.

424,380. Combined Conduit and Overhead System for Electric Railways, C. J. Van Depoele, Chicago, Ill.

424,381. Trolley Arm for Electric Railway Cars, C. J. Van Depoele, Lynn, Mass.

#### Issue of April 1, 1890.

424,699. Electric Car Motor, E. M. Bentley, New York, N. Y.

424,845. Electric Railway, E. M. Bentley, New York, N. Y.

424,848. Electric Railway, Thomson-Houston Electric Co., N. Y.

424,535. Electric Motor, L. Bock, Jr., New York, N. Y.

424,607. Operating Electric Railways, Thomson-Houston Electric Co., Boston, Mass.

424,928. Electric Railway, Thomson-Houston Electric Co., Conn.

424,887. Electric Railway, W. H. Knight, New York, N. Y.

424,888. Electric Railway, W. H. Knight, New York, N. Y.

424,935. Cable Grip, Standard Underground Cable Co., Pittsburg, Pa.

424,619. Means for Releasing Grips on Cable Cars, J. H. Robertson, New York, N. Y.

424,832. Automatic Cable-Lifter for Electric Railways, J. C. H. Stut, San Francisco, Cal.

424,833. Automatic Tension Device for Cable Railways, J. C. H. Stut, San Francisco, Cal.

424,693. Elevated Railway, E. M. Turner and J. P. Taylor, Fort Worth, Tex.

#### Issue of April 8, 1890.

425,220. Crossing for Elevated Cable Railways, E. R. Guerra, Mexico.

425,226. Automatic Catch for Inclined Railways, R. L. P. Henne, Cincinnati, O.

425,077. Electric Railway Car, R. M. Hunter, Philadelphia, Pa.

425,076. Electrically-Propelled Vehicle, Thomson-Houston Electric Co., Boston, Mass.

425,380. Running Gear for Street Cars, F. W. Judson, Cleveland, O.

425,101. Support for Electric Railway Conductors, C. J. Kilian, Milwaukee, Wis.

425,049. Cable Car Fender, G. E. Rhodes, Kansas City, Mo.

425,282. Cable Tramway Pulley, W. E. and W. M. Winby, Birmingham, England.

#### Issue of April 15, 1890.

425,488. Contact Device for Electric Railways, Thomson-Houston Electric Co., Conn.

425,489. Electric Railway Contact, Thomson-Houston Electric Co., Conn.

425,408. Hydraulic Railway, E. H. Craw, New York, N. Y.

425,757. Electric Heating Apparatus for Electrical Railway System, Dewey Corporation, Syracuse, N. Y.

425,866. Electric Railway Car, Dewey Corporation, Syracuse, N. Y.

425,767. Electric Railway, T. A. Evans, San Francisco, Cal.

425,883. Electrically-Propelled Car, R. M. Hunter, Philadelphia, Pa.

425,950. Electric Railway, W. H. Knight, New York, N. Y.

#### Issue of April 22, 1890.

426,102. Electric Railway Contact, Thomson-Houston Electric Co., Conn.

425,991. Electric Motor, F. E. Davis, Boston, and J. Scott Jr., Plymouth, Mass.

426,269. Electric Railway System, L. Gutmann, Fort Wayne, Ind.

426,379. Electric Railway Car, J. C. Henry, Kansas City, Mo.

426,380. Electric Motor and Dynamo, J. C. Henry, New York, N. Y.

426,382. Electric Railway, Thomson-Houston Electric Co., Boston, Mass.

426,276. Grip for Cars of Inclined Roads, J. M. Isenberg, Mines, Pa.

426,306. Switch Movement for Street Railway, H. L. Nodder, Covington, Ky.

#### Issue of April 29, 1890.

426,980. Switch Attachment for Street Railway Cars, A. E. Appleyard, Boston, Mass.

426,580. Electric Railway, E. M. Bentley, New York, N. Y.

456,657. Electric Motor Car, J. A. Brill, Philadelphia, Pa.

426,658. J. A. Brill, Philadelphia, Pa.

426,708. J. A. Brill, Philadelphia, Pa.

426,799. Cable Grip, E. R. Guerra, Mexico.

426,935. Cable Grip, C. J. P. Heim, St. Louis, Mo.

426,817. Fare-Collecting Apparatus, R. L. Irvine, Nevada, Mo.

426,452. Crossing for Overhead Wires, J. Kuehule, Detroit, Mich.

#### Expired Patents.

The following patents are now public property, and may be used by anyone:

Manufacturers may determine to what extent they may act independently of patent rights, and inventors may gain an insight into the prior state of the art by consulting copies of them.

A printed copy of the drawings and specifications of any of the following will be furnished by Higdon & Higdon for 25 cents.

#### Expired During May, 1890.

138,848. Car Starter, S. R. and A. C. Bradley.

138,793. Applying Steam Power to Street Railway Cars, W. W. Crane.

138,839. Fare Box, H. Baranger.

#### Expire in June.

139,563. Car Starter, Field & Steger.

139,721. Car Starter, G. Lowden.

140,052. Street Railway Car, S. H. Little.

140,229. Car Starter, A. Whittemore.

### Electric Merchandise Company,

The merchandise business of the Sprague Electric Equipment Company, Rialto Building, has been purchased by a new corporation called the Electric Merchandise Company, whose offices hereafter will be at No. 11 Adams St., opposite the Pullman Building. This Company in addition to continuing the merchandise business of the old company will also manufacture and sell electric railway appliances for station, car and line work of all kinds, irrespective of system. Its experience in the Equipment Company has been such that it is peculiarly well fitted to recommend material which has been found, by practical use, to be the most satisfactory. Such connections have been made with eastern manufacturers that, in most cases, goods can be bought at the same prices of the Merchandise Company as direct from the factory, time and freight being saved as all goods will be carried in stock. Catalogues will be furnished on application. Mr. W. R. Mason has been appointed general manager.

### A Model Railway.

The Burlington Route, C. B. & Q. R. R., operates 7,000 miles of road, with termini in Chicago, St. Louis, St. Paul, Omaha, Kansas City and Denver. For speed, safety, comfort, equipment, track and efficient service, it has no equal. The Burlington gains new patrons, but loses none.



Business Notes.

During the last month the amount of new business contracted for by the Sprague Electric Railway and Motor company has been very large, and includes nearly every section of the United States.

Among the new roads which have ordered electrical apparatus are the West End Railway of Denver, Colorado; the Belt Line Electric Railway of Port Townsend, Washington; Citizens Rapid Transit Railway of Nashville, Tenn.; Utica & Mohawk Electric Railway of Utica, N. Y.; Magnet Street Railway of Quincy, Mass; Capitol Hill Electric Railway of Denver, Colorado; Rapid Transit Street Railway of Newark, N. J.; and Keokuk Electric Railway of Keokuk, Iowa.

In addition to these the Sprague company has closed a number of contracts for additional equipment with roads already in operation on the electric system.

The use of electricity as a motive power seems to be extending rapidly, and the lists which we publish each month of new contracts awarded is indicative of the popularity of the system.

Owing to the adoption of electricity as a motive power by the Minneapolis Street Railway company, the company offers for sale a considerable quantity of its old equipment, including 63 12' cars, fitted with fare boxes and small conveyors; 76 extra small conveyors for 14' and 16' cars; a number of Slawson fare boxes; 12 steam motors of from 15 to 20 tons. Two locomotives, two tenders, 20 and 25 tons, 21 passenger coaches, 26 to 40 feet, 34 open passenger excursion cars, one caboose and eight 30' flat cars. A number of these cars have only been in service for a short time, and are in first-class condition and the company will make any necessary changes in them and sell them very cheap.

The work on the electrical equipment of the Utica & Mohawk Electric Railway at Utica, N. Y., a contract for which was closed last month by Higgins Bros. & Co., of Buffalo, is being carried forward as rapidly as possible, and it will not be long before the cars will be ready for operation. Five thirty horse power car equipments have been contracted for and shipped, together with all necessary station equipment.

Announcement.

ST. PAUL, MINN., May 19, 1890.

Dear Sir—We wish to call your attention to the fact that this company has recently purchased the buildings, machinery, stock, patents, etc., of the Acme Electric Company. We have in addition to this acquired other valuable rights, which, together with ample capital, afford us excellent equipment for installing electric lighting plants, doing all kinds of construction work, and for furnishing electrical supplies of every description. Special attention will be given to the matter of repairs in all of its branches, including the winding of armatures of the various makes.

Should you see fit to do any business with us, you will find us prompt in filling orders, and our best endeavors will be exerted to give satisfaction in every particular.

Very respectfully,
JOS. A. HUMPHREYS,
Secretary.

Removal.

BOSTON, April 24, 1890.

Dear Sir.—We beg leave to inform you of the removal of the New England Electric company, sole New England agent of the Sprague Electric Railway and Motor Co., to its new offices, No. 12 Post Office Square, and to invite your attention to our full line of electric motors, from one-eighth to one hundred horse power.

We are prepared to contract for equipping electric railways, installing electric power in cotton, woolen, shoe and other factories, and for the far transmission of power from water courses or other sources of supply.

We cordially invite you to call, and shall be happy to furnish you with any information relating to electrical power.
NEW ENGLAND ELECTRIC CO.

George F. Steele, President.
Edward Blake, Treasurer and General Manager.

The Short Electric Railway Company has received its second order for railway equipment from the Muskegon Railway Company. After the successful opening of the road, April 20, the council voted unanimously in favor of the extension of the franchise of the Railway Company, and with true Muskegon enterprise, work was begun at once on two of the three extensions planned. By June 20, the Lake Michigan Line will be in operation with eight cars and three miles of track, while the Muskegon Heights Line will be ready as soon as the equipment can be had. Two 100 horse power generators will be placed in the new power station when it is completed. At present the machines are in the power house of the Electric Light Company, which is crowded to its utmost capacity.

The Adams & Westlake company, of Chicago, has recently gone into the manufacture of brass bedsteads, and in a very short time expect to be in the closest competition with the best English manufacturers of these useful articles.

Mr. E. M. Morris, Supt. of the Colerain Avenue Electric Railway of Cincinnati and President of the Novelty Electrical Supply company of same city has been in Chicago for a number of days attending to some patent interference business. Mr. Morris expresses himself as being extremely sanguine about business prospects in general and electrical railway matters in particular, and the ten thousand dollar order he received lately from St. Paul for iron poles, equipped with the combination pole top, of which he is the patentee, did not tend to dampen his enthusiasm in the slightest degree.

C. E. Loss, of Chicago, has closed a contract for the construction and electrical equipment of the recently incorporated Calumet Street Railway Company of Chicago. A girder rail is to be used, and, probably the overhead system will be adopted. Connection will be made with the Pullman Street Railway, and, may be, with the Cottage Grove cable line.

About the middle of last month a number of prominent gentlemen went out to Pullman to see the operation of the Patton motor. A ride over the entire line was taken by the party, and the greatest satisfaction was expressed at the perfect working of the motor.

The Connolly Motor company has one of its motors in daily operation in Chicago on Western Avenue between Lake and 40th streets and it is working nicely.

The Great Northwest

Has attractions for everybody. Within its territory are comprised the great States of North and South Dakota, Montana, Oregon and Washington, and the Territories of Wyoming and Idaho. Famous as have become the scenes found within the boundaries of these great divisions, yet there are thousands of people who have never beheld them, and thousands who are not aware of the wonderful resources awaiting development. Rugged mountains, fertile plains and valleys, a wealth of timber and minerals, splendid stock ranges, pure water, healthy and invigorating climate, good markets, churches and schools, and convenient railroads are all to be found. If you contemplate a visit to this region, either for business or for pleasure, do not forget that the best route is via the Chicago, St. Paul & Kansas City Railway, whose splendidly equipped trains connect at St. Paul and Minneapolis with through trains of the Northern Pacific and Great Northern Roads for all points in the far Northwest, including, also, Manitoba, British Columbia and the Pacific Coast. Information concerning rates, etc., furnished on application to W. R. Busenbark, General Passenger and Ticket Agent, Chicago, Ill.

WANTED—To purchase street railway bonds, horse, cable or electric. Give full details. C. V. E., 8 Lakeside Building, Chicago.

WANTED—Party having experience to buy controlling interest in a well paying street car building enterprise. Lots of orders on hand. Will furnish necessary capital. N. E. D., care Gazette Office.

Electric Street Railways in North America.

IN OPERATION OR UNDER CONTRACT MAY 1, 1890.

Table with columns: OPERATING CO., LOCATION, SYSTEM, CARS, MILES. and OPERATING CO., LOCATION, SYSTEM, CARS, MILES. listing various street railways across North America.



# The Street Railway Gazette.

(Copyrighted, 1890.)

VOL. V.

CHICAGO.

JULY, 1890.

CHICAGO.

No. 7

## ELECTRIC RAILWAYS.

### Electric Railway Power House.

The power station of the Citizens' Street Railway company at Indianapolis, Ind., in the illustration is of sufficient capacity to contain twenty-three Thomson-Houston railway generators, and at the same time affords room for offices and general machine shop. The boiler plant is to consist of three Hazelton boilers, fit-

that any number can be run at the same time, and any one can be started and stopped while the remainder of the plant is in operation. The shafting is made of the best quality of hammered steel, and is supported by ball and socket self-oiling bearings. This, it is stated, is the first system that has been equipped upon this plan, and it is found to be highly satisfactory. The steam piping for this plant is of ample capacity, and so arranged that when the whole plant is in operation every detail will be of

concrete base with the brickwork on top laid in cement, and everything about the plant is constructed in the most substantial manner possible. The engine, which has just been put in operation, was built by the Wheelock company of Worcester, Mass. The entire installation was planned and erected by L. H. McEntire of the railway engineering department of the Thomson-Houston Electric company. The work of installing the plant was in charge of W. S. Twining.

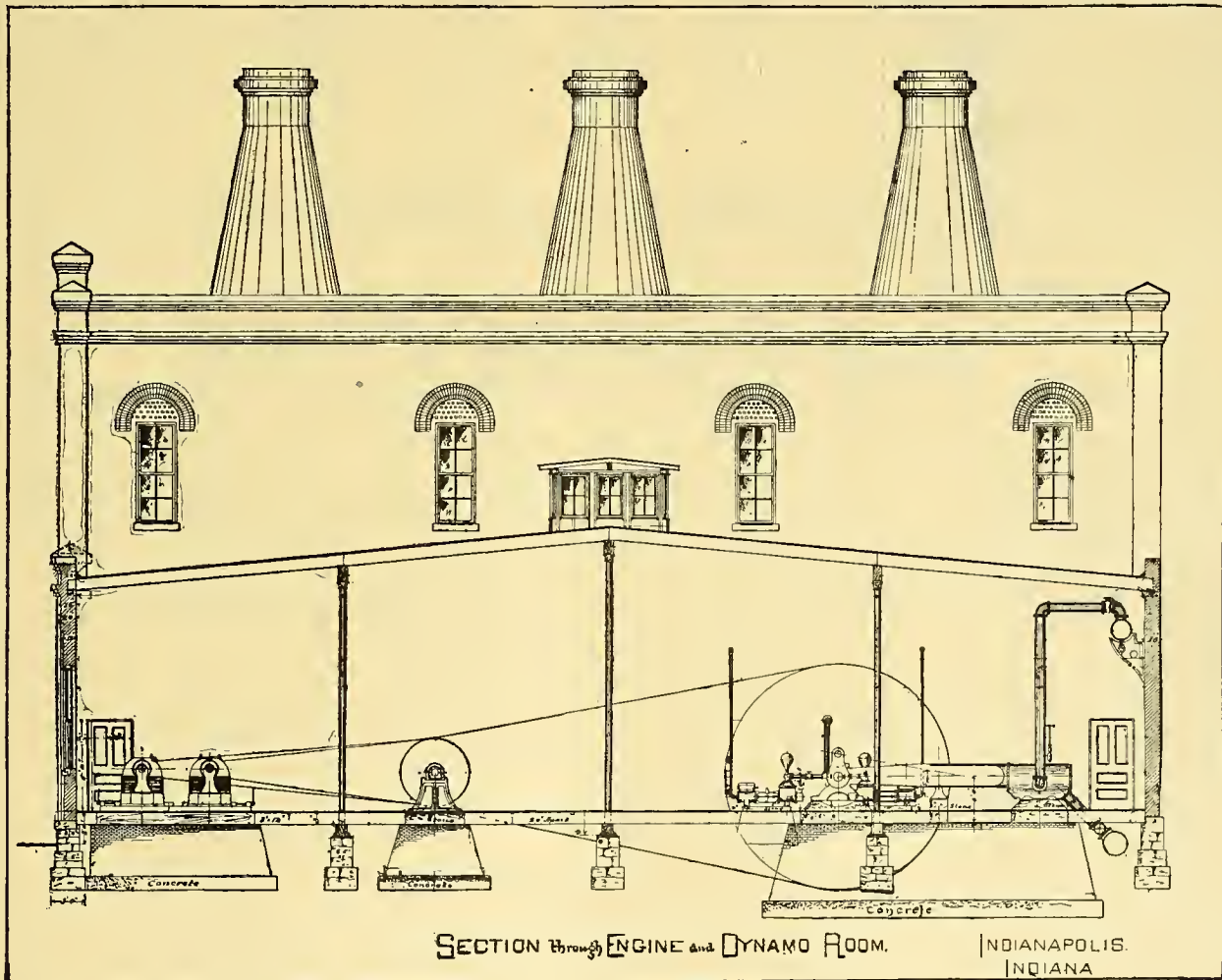

SECTION THROUGH ENGINE AND DYNAMO ROOM.

INDIANAPOLIS,  
INDIANA

ted to burn natural gas, and also arranged with furnaces to burn coal, as shown by the three extensions to each boiler on the plan. The gas burners in each boiler are located in such a manner that they do not interfere in the slightest with the coal furnaces. It is possible to make a change from gas to coal at a moment's notice. This is a very great advantage over the ordinary practice, as it is customary to place these burners on the grates. Whenever it was desired to use coal it was then necessary to remove them, which is by no means an easy task. The engines are so arranged and connected

proper size and proportion. The feed water for the boilers is first passed through a Hoppes purifier, which removes the impurities and heats the water at the same time to the boiling point. The water is then pumped by Barr duplex pumps into the boilers. The entire feed-water system is arranged in duplicate, so that in case of accidental injury operations would in no way be interfered with.

The general arrangement of this installation is shown by the cut representing a section across the engine and dynamo room. The entire installation rests upon masonry, consisting of a

### A Card.

Mr. Thomas G. Smith, Jr., late of Cincinnati, O., has now been admitted to partnership in our firm.

Mr. Smith was formerly identified with the Ball Engine in Cincinnati. He is a member of the Society of Mechanical Engineers, and having been with us for some time is already familiar with the requirements of our business as consulting and contracting engineers.

Very truly,  
New York,

Charles R. Vincent & Co.



### The Electric Current as a Traction Increaser.\*

BY ELIAS E. RIES.

Within the past three or four months a number of articles have been published in the electrical journals purporting to show, some theoretically and others by experiment, that the passage of an electric current between a driving wheel and rail could have no effect in increasing the traction or coefficient of friction between the two surfaces in contact, and that if the current had any influence at all upon the friction it could only act to reduce the traction instead of increasing it.

As the writer was probably the first to call general attention to the importance of increasing tractive adhesion by the direct action of the electric current, and the first to point out the laws bearing upon this subject, as determined by experiments made by him several years ago for that purpose, it seems fitting that he should reply to these articles.

It appears to have been taken for granted by many persons, probably because the phenomena of increased traction were first observed in the operation of electric railway motors, that the mere use of the track rails as the return conductor in an electric railway system is all that is necessary in order to insure increased adhesion between the motor wheels and the rails. This is by no means the case, as the result is entirely dependent upon the nature of the current employed and the circumstances under which it is permitted to act.

As a matter of fact, the conditions existing on single trolley railways, as at present operated, are not such as to be favorable to the production of increased traction, and although a certain amount of increase in adhesion occasionally manifests itself, it is not such as to be relied upon with any regularity or certainty, and is due, as will hereinafter appear, to causes entirely different from those that

1. The current must be of such volume as to produce an appreciable amount of heat at the point or points in contact.

2. The electromotive force must be as low as possible. Experiments made by the writer have shown that a high electromotive force has a tendency to diminish friction, especially if the pressure between the surfaces in contact is a moderate one.

3. The metals in contact should be of iron or steel, as these have the requisite electrical resistance at their contact surfaces and are of such molecular structure as to permit of a close and intimate union between them under the influence of the current.

4. One or both of the metals should preferably roll upon the surface of the other. This is desirable in the first place, in order to economize current by concentrating the heating effect upon as narrow a line of contact as possible. Furthermore, a rolling motion, where the line of contact moves progressively and uniformly along both surfaces, as in the case of a wheel and rail, where the contact is continually established at new points, requires less current to produce a given tractive effect than in case of sliding friction, where the surfaces move at different rates of speed, and are never in fixed relation to each other for an appreciable length of time.

Let us now see whether or not these conditions have been fulfilled by those who have endeavored to show that the electric current is incapable of increasing tractive adhesion. We will then look at the matter from a more practical standpoint, and show what the electric current has done, and is capable of doing, in this direction, when properly applied.

Prof. Lucian I. Blake, in a paper recently read before the Kansas Academy of Science, describes and illustrates a number of experiments stated to have been made for the purpose of determining whether an electric current would, as stated, increase the friction between a wheel and rail in

traction can result from the direct passage of an electric current from wheel to rail, or vice versa, because there would not be sufficient "attractive" force produced. It is further stated that the passage of current in this manner could only result in a repellant action between the metals in contact, the author citing, among other things, the action of the electro-motograph in support of his views, and in general denying that increased traction could result by reason of any change, molecular or otherwise, caused in the surface of the metals by the action of an electric current, notwithstanding the fact that elsewhere in his communication he admits having witnessed an experimental demonstration in which the current did have the effect which he endeavors to prove it could not have. It is needless to state that there is not the slightest basis for any of the theoretical conclusions referred to, which probably arise from a misconception of the real actions to which the increased adhesion is due.

We will now consider the part the current plays in the production of increased traction. It has already been said that this phenomenon is directly due to the heating effect of the current upon the metals at their point of contact. A certain slight magnetic effect is necessarily also present, but this is so small in the case under consideration that it does not enter to any appreciable extent into the result, and may therefore be neglected. This heating produces a molecular change in the surfaces of the metals which causes a variation in the coefficient of friction between them, but the nature of this variation and the manner in which the increased adhesion is produced depends upon the nature of the metals and the degree of heat developed at their points of contact. As an illustration of this it may be stated that a moderate current of sufficient strength to cause increased adhesion between iron or steel surfaces will have a lubricating effect upon brass contacts and cause a diminution of normal friction between them, although with sufficiently large current the friction may be increased.

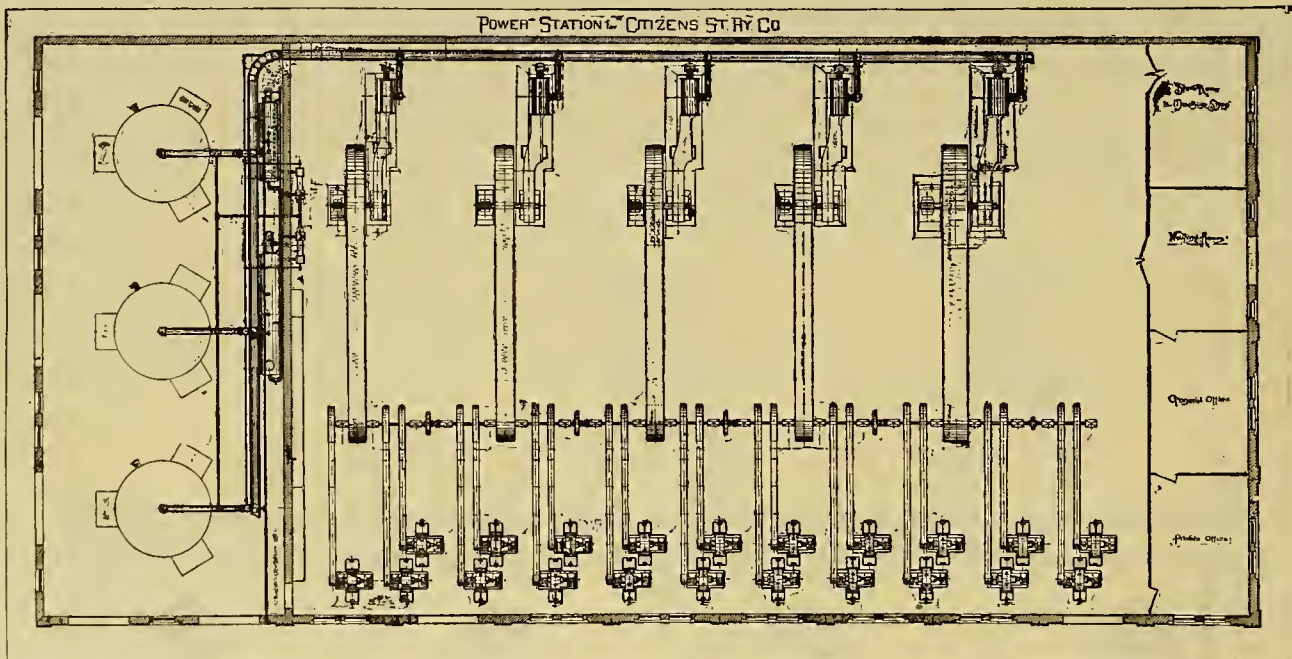

produce increased traction in cases where a local or independent traction circuit moving with the vehicle is employed, such as embodied in the method of electrically increasing traction devised by the writer.

In my original paper upon this subject, read before the American Association for the advancement of Science in August, 1887, the underlying principles and conditions governing the production of increased friction by the action of the electric current were set forth for the first time in the following paragraph:

Before entering into a description of the means by which this result is produced and how it is produced to apply this method practically to railway and other purposes, it may be well to give a general outline of what has so far been determined. These experiments have shown that the coefficient of friction between two conducting surfaces is very much increased by the passage therethrough of an electric current of low electromotive force and large volume, and this is especially noticeable between two rolling surfaces in peripheral contact with each other, or between a rolling and stationary surface, as in the case of a driving wheel running upon a railway rail. This effect increases with the number of amperes of current flowing through the circuit of which the two surfaces form part, and does not materially depend upon the electromotive force, so long as the latter is sufficient to overcome an electrical resistance of the circuit. This increase in frictional adhesion is principally noticeable in iron and steel, although present in other metallic bodies, and is due to a molecular change in the conducting substances at their point of contact (which is also the point of the greatest electrical resistance in the circuit), caused by the heat developed at that point. . . . The most economical and efficient results have been obtained by the employment of a transformed alternating current of extremely low electromotive force, but of very large volume or quantity, this latter being variable at will, so as to obtain different degrees of frictional resistance.

The correctness of the principles originally set forth in the above paragraph have been repeatedly substantiated by subsequent experiments, and it will be seen therefrom that, in order to produce increased traction by the direct action of the electric current, the following conditions must be observed:

\*Electrical World.

electric railways. Four different experiments are described, not one of which even approaches the conditions met with in railway practice. In two of these experiments such metals as platinum immersed in flowing mercury and a brass bar sliding upon brass rails were employed! The flat surfaces in frictional contact "varied from 1 1/2 to 3 square inches," an amount several times greater than the combined effective area of contact of four ordinary railway car wheels, while the current sent through these surfaces was several times less than that ordinarily used in railway practice, being but 1 ampere and 10 amperes respectively! The two remaining experiments illustrated a case of rolling or skidding friction in which the current used was presumably the same as in the first experiment, "varying from 0 to 1 ampere." In short, those experiments seem to have been devised for the express purpose of showing "how not to do it," since Prof. Blake himself admits in concluding that "the currents employed were not sufficient to produce heating at the surface of contact," and adds that "such heating would doubtless produce an increase of the coefficient of friction."

Mr. O. T. Crosby has also described some dynamometer tests tending to show that no increase in traction occurs. These tests were made by him with an ordinary single trolley motor car, and consisted in first returning the motor-operating current through the wheels and rails in the usual manner, and then repeating the experiments with the wheels out of circuit. The current employed was varied from 0 to 42 amperes during the experiments, and the electromotive force, though not stated, was probably 500 volts. Unfortunately, the capacity of the dynamometer at Mr. Crosby's disposal was less than that needed to register the ordinary tractive effort of the car on a level track, and he found it necessary to jack up one end of the car so as to skid only one pair of wheels and to relieve these of a part of their weight. It will be apparent from what has been said that the conditions under which these tests were made were not only unfavorable to the production of increased traction, but were of such a nature as to bring about the very opposite result.

There seems to be an impression among many persons that the increased traction, if present, must be due in some way to magnetic action. This view of the matter has been taken by Mr. Nelson W. Perry, of Cincinnati, who endeavors to show that no appreciable increase in

Experiments have shown that in the case of iron and steel a comparatively slight amount of heat will serve to increase the friction to an appreciable extent, this being due to a slight expansion and elevation of the metal at one or both sides of the normal line of contact. This action is practically spontaneous, the heating effect taking place on the surfaces of the metals long before the body of the latter have had time to become sensibly warm. That the particular effect here referred to is due principally, if not entirely, to the heat, and not to the current directly, is proven by experiments made by the writer with a small electrical railway model, in which the increased friction continued an appreciable length of time after the traction current had been cut off, the wheels of the motor car having been previously heated by the current so as to retain for a time a portion of the heat imparted to them.

The friction between driving wheels and rails is considerably increased beyond this point, however, by increasing the current strength so as to produce a still greater local heating of the metals at the point of contact, and this is the method preferred by the writer, and most economically carried out by the use of a closed traction increasing circuit of low resistance, moving with the vehicle and including the driving wheels and that portion only of the track rails that lie between them. When the current strength is sufficiently augmented the increased traction becomes due to an incipient welding of the metals along the line of contact. This action leaves no permanent trace upon the wheels or rails, nor is there any appreciable increase in rolling resistance noticeable. The writer has even increased the current strength so as to produce an actual weld between the wheels and the rails, without material injury to either of the rolling surfaces; in some experiments, on overcoming inertia, the metals separating again on the line of the weld, the film of oxide between them. By the employment of a converted alternating current of high periodicity with respect to its volume the heating effect may be confined to the surface of the rails without penetrating into the interior. As a rule, the amount of current needed to produce a given increase in traction is found to be proportionate to the area of the surfaces in contact and, to a certain extent, to the speed of the driving wheels. The condition under which increased traction is called for in practice is favorable to the use of a comparatively small amount of electrical energy for this purpose, since it is only in sta-



ing heavy loads and in ascending grades, when the rate of speed is much below the normal, that increased adhesion is usually required.

The writer has recently had occasion to construct a small electric motor car and track with which a number of important facts bearing upon this subject have been satisfactorily illustrated. This model is still in existence and may be seen in successful operation at the writer's office, room 27, Chamber of Commerce Building, Baltimore, at any time. The apparatus in question consists of a small electric railway car having two driving axles insulated from each other and operated by a small electric motor supplied with current through flexible conductors in circuit with a single cell of secondary battery. The driving axles are arranged so that one of several sets of iron or steel driving wheels of different diameters can be placed thereon. The traction increasing current is derived from an independent source and is varied according to the requirements of the experiment in hand. This current, by means of a second pair of flexible conductors connecting with binding posts on the car, is sent from the forward to the rear driving axles through the intervening driving wheels and track rails, although the arrangement is such that it can be sent directly from one rail to the other across the wheels and axles, thus enabling the terminals of the traction circuit conductors to be attached to the rails at one end of the track instead of being carried by the motor. The weight upon the driving wheels without extra load is about three pounds.

With this apparatus, employing a continuous traction-increasing current derived from one cell of secondary battery, the tractive effect of the motor car was increased considerably over 150 per cent, the car climbing grades of thirty feet to the hundred with perfect ease against the pressure of a spring tending to pull it backward; whereas, with the same propelling current flowing through the motor, but with the traction circuit open, the car remained spinning at the bottom of a 10 per cent. grade, not having sufficient tractive adhesion to lift its own weight. Upon again closing the traction circuit the car instantly regained its grip upon the rails and shot up the incline until its forward upward progress was stopped by the distended spring and cord that secured the car to a post at the lower end of the track and prevented it from running over the top of the incline. No sparking, flashing or other visible indication that current was passing between the wheels and rails could be observed in this experiment.

There is no mistaking the action of the motor, or the important part the current plays in increasing tractive adhesion. If while the car is ascending a steep grade, the traction increasing circuit be opened and then again closed, the car will commence to slip backward and continue doing so with accelerated speed until the moment the circuit is completed whereupon its descent will be almost instantly checked, and it will promptly proceed to mount the grade again as if nothing had happened.

Among other things, it was shown by this apparatus, as originally predicted, that the traction is not diminished, but (compared with mechanical traction under like conditions) enormously increased when the rails are wet or slippery. The presence of water on the rails seemed to make no difference in traction while the current was passing. With the rail and wheel tires thoroughly oiled the car remained stationary with the motor running at the bottom of a 6 per cent. grade. One end of the track was then elevated to form a 25 per cent. grade, and on closing the traction circuit the little car actually climbed up the slippery track as far as the spring would permit without a single idle revolution of the driving wheels!

On increasing the traction current by connecting a second cell in series with the first, so as to produce a perceptible and progressive incipient welding between one or more of the wheels and rails, the tractive pull of the car on a level track, as measured by a standard spring balance dynamometer, was rapidly increased from six ounces, the normal pull without traction current, to 31 ounces with the current, *an increase of over 500 per cent!* Were it not for the fact at this point the load and the tractive adhesion exceeded the maximum power developed by the little motor, the increased traction actually registered would have been much greater. With the same current passing between the wheels and rails the car performed the remarkable feat of ascending without any slip a 50 per cent. grade, *part of which was coated with oil!* This experiment has since been witnessed by a number of prominent electricians and engineers, who expressed themselves as astonished beyond measure at the wonderful increase in friction obtained, and the comparatively small amount of electrical energy required to produce it.

In order to determine some of the conditions bearing upon the application of this system of increasing traction to ordinary railway train service, a series of preliminary experiments upon a large scale were made by the writer nearly a year ago with a locomotive on the Philadelphia & Reading Railroad.

These tests were made with a locomotive selected by the railroad company, a "consolidated engine weighing 111,000 pounds (one of the heaviest and most powerful in the service of the road), of which 98,000 pounds or nearly 50 tons, were distributed over eight coupled driving wheels, measuring about 34 inches in diameter. The traction current was generated by a special low tension, direct connected steam driving dynamo mounted upon the locomotive, one terminal being connected by a heavy standard copper cable with the forward and rear pair of drivers respectively, which were insulated from the frame of the locomotive by special insulated brasses at the boxes and journals, the opposite terminal of the dynamo being connected with the two intermediate pairs of drivers. This arrangement was adopted to avoid interruptions in the circuit at the rail joints, which on this road, as is usually the case elsewhere, were not directly opposite on both rails, but overlapped. The average resistance of the traction circuit with the locomotive at rest measured less than one two-hundredth of an ohm, practically all of which was located at the respective points of contact between the wheels and rails. The current

could be varied during the different tests by varying the field strength or speed of the dynamo, or both, from about 500 ampères to the maximum output of the machine.

The first experiment was made on a substantially level track, and consisted in coupling the locomotive to a train of 12 loaded coal cars and setting the brakes on these so that the engine could not possibly start the train without continuous slipping, several unsuccessful attempts to do so being made. The dynamo was then started up and the trial repeated with *entire success*, the train being brought under full headway from a position of rest without a single slip of the wheels. This was repeated a number of times, the engineer being instructed to do his utmost to make the wheels slip while the current was flowing, as by suddenly throwing open the throttle to the widest extent with the eccentric lever in its foremost notch, etc., without effect. It was estimated that the load moved by the engine during this test was equivalent to a train of 110 cars!

A number of subsequent tests were made on the Frackville branch of the Reading Railroad, upon a steep mountain grade seven miles in length, averaging 185 feet to the mile, and with numerous sharp and difficult curves. Regular service runs were made over this grade both with and without the current, under conditions as nearly alike as the traffic over the road would permit, with entirely satisfactory results. The official records of the tests show that in nearly every instance the use of the current produced a decided increase in the tractive capacity of the locomotive, and prevented the enormous wear and tear, loss of time and consumption of coal occasioned by the excessive slipping that took place when natural adhesion alone was relied upon. On one occasion the time required to ascend the grade with a load slightly in excess of that usually carried was, without current, 55 minutes, as against 29 minutes with the current flowing, under exactly similar conditions. The amount of coal consumed on the last named trip was *less than one half* of that used on the trip without current, by reason of the absence of the rapid exhaust and loss of power consequent upon the slipping of the drivers.

These tests, though made under some disadvantages, were so satisfactory that they are now being continued under conditions and auspices more favorable for carrying out this work. It is estimated that the tractive adhesion of steam locomotives can by this method be increased 25 per cent., and even more in special cases, or where the construction of the locomotive is such as permit it to utilize a greater increase. This not only means that four locomotives will be enabled to do the work that now requires five, but that longer and heavier trains can be moved, better time made, steeper grades operated, quicker stops effected, inertia more promptly overcome and more fuel saved than by the present methods, and what is perhaps of the greatest importance, without any material increase in the weight upon the drivers or roadbed. These and other advantages are by no means limited to steam locomotion, but apply to electric railway operation with equal or even greater force.

The question will now be probably asked: "Are the conditions existing on electric railways employing the rails as a return conductor for the propelling current such as render this current a factor in increasing the traction, and, if so, to what extent?" Before answering this question let us briefly review these conditions.

In the early days of electric railways the potential difference under which the motors were operated was very small, in some cases as low as 120 volts, and the currents correspondingly large. The track rails were usually of some obsolete light weight T pattern that had done more or less service on some suburban horse railway line, and the bearing surface of which was curved to such an extent that the driving wheel contact amounted barely to a point. Under these circumstances a useful amount of increased traction was obtainable, especially in starting the motor on a grade, when the flow of current was unusually heavy. On "single trolley" railways, as at present operated, under a potential difference of 500 volts, the currents employed are not sufficiently large to produce increased traction by the *direct heating* of the metals in contact, except when, as sometimes happens, the tread of the wheels runs upon an exceedingly narrow portion of the rail surface, and even this effect is large if not entirely counteracted by the high E. M. F. of the current.

However, a certain amount of increased traction may be, and often is, *indirectly* produced by the current on single trolley railways. This occurs when the contact between the wheels and rails is temporarily interrupted at more or less frequent intervals by particles of sand or other foreign matter on the rails, thereby giving rise to small electric arcs and producing the "flashing" noticed under these conditions. The heat generated by these arcs is, in many cases, sufficient to soften the metal and to cause an actual fusing or welding action between the surfaces of the wheels and rails when they again meet beyond the grain of sand or other obstruction, the latter being sometimes vitrified or decomposed by the arc, or imbedded in the heated metal. As the car moves forward, the arc, which is originally sprung behind the obstruction, advances along the wheel and rail to a point in front of it, and the points of the metal thus heated, approaching each other, unite under pressure and almost instantly cool, extinguishing the arc in so doing and producing a more or less perfect weld at the point of contact, to which the increased traction is due. The welds thus formed are again broken, during the separation of the wheel and rail services, on their line of least resistance, which is generally that corresponding to the original surfaces because of the film of oxide and other impurities usually found between the fused metals, and which in most instances prevents a homogeneous weld.

From this it will be seen that notwithstanding the small volume of the current on single trolley railways an appreciable amount of increased traction may manifest itself by reason of the comparatively high electromotive force, producing a change in the action of the current. The use, for example, of a moderate amount of sand in conjunction with the current on grades of more than usual steepness will

serve to increase the adhesion both mechanically and electrically to a certain extent, but this plan is not nearly as efficient, economical or reliable, leaving out for the present the question of its advisability, as the employment of a current of lower voltage and larger volume for the direct and uniform heating of the contact surfaces.

It may be stated in conclusion that, while it is possible to obtain a certain appreciable percentage of increased traction on electric railways in which the propelling current is returned through the wheels and track rails, and while in some few cases a slight increase is necessarily present as a function of the propelling current, yet the conditions under which such roads are usually operated are not favorable to the production of such increased traction. Numerous experiments made by the writer have shown that the most satisfactory and economical method of employing the electric current as a traction increaser, whether on steam or electric railways, is to establish an independent low resistance circuit, including the driving wheels and so much of the track rails as lie between them, and to charge this circuit with a low tension traction current capable of producing the desired heating effect. As this circuit is entirely independent of, even though it may be derived from, the motive power of the vehicle, the amount of increased traction can be regulated without regard to the speed of the motor, and can also be used on down grades to assist the brakes in stopping the car. The increase in the adhesion on single trolley roads under the most favorably conditions is limited by the low heating effect of the propelling current, whereas in the case of the independent traction circuit there is practically no limit to the amount of increased adhesion obtainable, since this adhesion may be increased to such an extent as to actually weld or "freeze" the driving wheels to the rails.

## Electric Motors in General Railway Work.

BY DR. LOUIS BELL.

(Continued.)

A curious complication is introduced by the fact that if we were to operate a long line in sections, we should find, as the inspection of any time table will show, that on certain sections no more than one train could be running at one time, while on others several trains would have to be operated simultaneously. On these last sections larger distributing conductors would be needed, and a little study of the time table might result in a very considerable saving of copper. As the motor used would be a series motor in any case, I see no objection to working it at a constant current on one-train sections, if anything were to be saved by it.

I will now consider the power which would be required and the economy that might be obtained in an actual case, taking a single section for an illustration. The case which I am going to suppose is a transformation of the Big Four Line, from Chicago to Cincinnati, into an electric road, so far as passenger trains are concerned. The length of the line is a trifle over three hundred miles, and I shall suppose it to be divided into some ten or twelve sections, each with a power station at its middle point. This arrangement of the power stations evidently will secure the greater average economy. The road is a single track one, and the hypothetical section which I shall investigate is the section between Kankakee and Sheldon, Indiana, a distance of thirty miles. I take a case of this sort to show what will be the actual power required and the proximate economy, in the case of an actual railroad running its regular train on its present schedule time.

In looking over any time table it will be noticed that any such given section will only require power at certain hours of the day, and a varying amount according as one or more trains may be operated at the same time. Having worked out the times for supply power and the probable amount, I shall then investigate the probable economy of a hypothetical electrical equipment.

Looking over the time table of the Big Four Line, between Kankakee and Sheldon, it appears that passenger trains were on the section during the following hours: 10:25 A. M. to 12:35, 1:40 to 3:10, 10:25 to 11:32 P. M., and again in the early morning from 3:20 to 4:30. From 1:40 to 3:10 two trains are simultaneously upon the section; at all other times only one train would have to be operated at a time. Looking further, we should find that, by changing the time of the two local trains from Kankakee to Sheldon, which do not connect with anything, and by changing that time only a few minutes, it would never be necessary to operate more than one train on a section at a time. Making these changes, the hours of supplying power would be 10:25 A. M. to 3:10 P. M., 10:25 to 11:32 P. M., 3:20 to 4:30 A. M. The problem then resolves itself into supplying power enough to operate an ordinary train at the usual speed, and at a maximum distance of fifteen miles from the power station.

Let us now suppose the motor to work at 1,500 volts at its terminals at the end of the section. The power required to operate the train would be about 200-250 horsepower at the average speed, consequently the current transmitted over the line would be about 100-125 amperes.

Of course we might suppose any number of hypothetical line equipments, but I shall confine myself to one in which the amount of copper required will not be specially forbidding. I shall suppose a line wire No. 0, connected at short intervals to a bare trolley wire of silicon bronze, or some similar alloy, size No. 1. The conductivity of this system is more than equivalent to a single wire No. 000, on which I should base my calculation. I should suppose track and ground systems to be made in the ordinary way. The length of conductor on each side of the central station would be about 70,000 feet, and the fall of the potential for 100 amperes over this distance would be a little over 500 volts; the generator therefore would have to develop a little over 2,000 volts and the line efficiency at the terminals of the section would be nearly 75 per cent. The average line efficiency for the entire section would probably be somewhere nearly 85 per cent. The total amount of copper required for the section would be about 110,000 lbs.,



including insulation, or about 3,600 lbs. of copper per mile. With, therefore, this amount of copper, which seems not at all excessive, we should have an average line efficiency of about 85 per cent., and assume for the efficiency of the motors and gears 80 per cent., which, for motors running at high speed and infrequent stops, does not seem an excessive estimate, the mean commercial efficiency of the combination would be a little above 60 per cent. In other words, taking into account all sources of loss, we should probably have an efficiency of a little over 50 per cent. from the indicated horse-power at the engine to the power supplied at the axles of the car.

Now let us look a little further and see the amount of power which would have to be supplied to the section which we have been considering. Looking over the time schedule we see that power is required for almost exactly seven hours, and to supply 200 horse-power necessary at the train, we should have to furnish about 400 horse-power indicated at the power station. We should therefore furnish 2,800 horse-power hours to the section under consideration, and we should have the advantage of being able to use compound condensing engines. These engines ought to be able to furnish the indicated horse-power on 2 lbs. of coal; the coal required for our supposed section then would be 6,500 lbs for the twenty-four hours. Banking fires between runs would consume some little coal beside, but with proper engines and good firing the 2,800 horse-power hours ought to be furnished on three tons of coal.

For express speeds, of course, 200 horse-power would be too small and the coal consumption would be larger, while the line efficiency would be slightly lower. Still, in our supposed case we could count on a mean efficiency of 50 per cent. from indicated horse-power to train, for, while fast trains would entail greater loss in the line, the average figure would not be seriously lowered. This amount is probably a trifle less than would be required by the locomotives doing the same work. Seven to eight lbs. of coal per car, which is a fair estimate for passenger trains, and as we may take the trains to average five cars, the amount required on the section per train would be from 1,000 to 1,200 lbs., or for the six daily trains probably 7,000 lbs. This would probably be even in this extreme case a slight saving of fuel.

We are now in a position to form a tolerably clear idea of the probable cost of equipping such a section as we have been discussing. We shall require for equipment a 400 horse-power compound condensing engine, and dynamos to match, and we shall require, as before mentioned, a little less than two tons of copper per mile. In return for the investment in these items, we get an average commercial efficiency of a little over 50 per cent., and the question to be raised is the exceedingly practical one, will it pay? We gain the advantage of being able to use a very economical engine. We gain a certain number of employes who may be dispensed with. To make these gains we have contented ourselves with an efficiency of 50 per cent.

It is worth noting, too, that the mean efficiency of such a section can not be raised to a very high figure, for the reason that even with the small amount of copper specified most of the loss is in the double transformation effected by dynamos and motors, and not in the line. If the amount of copper were doubled we should still have to be contented with a total commercial efficiency of about 60 per cent.

In Mr. Sprague's very able paper before the National Electric Light association, he has pointed out the economy secured by multiplying power stations and using shorter sections. The practical way to put the question of economy to be thus secured is this: Will it pay to double the expense for power stations to save three quarters of the outlay in copper; or will it pay to double the cost of power stations for the sake of saving the above proportion of the power lost in the line? This view is necessarily somewhat limited, for in the case of compact systems the saving can be effected without anything like doubling the cost of power stations. Without going into detailed estimate, it would seem doubtful whether there would be much practical economy in an extensive system of power stations. The three-wire system suggested by Mr. Sprague, in the same paper, is a much more practical way of securing economy, and may come into extensive use. On a double track road, such as we have in suburban or elevated roads, this three-wire system could be operated at very great advantage.

Let us now look at the locomotive a little, for the purpose of seeing whether we are going to gain enough in saving of coal and wages to pay for 40 or 50 per cent. energy lost in the various transformations of the electric system.

There seems to be a widespread popular delusion to the effect that the locomotive is an exceedingly uneconomical machine. On the contrary, the figures of actual tests show that the locomotive compares very favorably with ordinary non-condensing engines of similar size. Several locomotive tests made in New England, a few years since, gave the horse power hour on between four and five lbs. of coal, or with the evaporation of less than thirty lbs. of water. Figures obtained with the Strong locomotive show even better results, some of the runs being made on less than four lbs. of coal per indicated horse power hour, and the average results being most remarkable.

Various foreign experiments point in the same direction, to show that a well cared for locomotive will give the horse power hour on twenty-seven to thirty pounds of water, even the small engines on the New York elevated road, working as they do with an average horse power only 38 per cent. of the maximum, still consume only six and two-tenths lbs. of coal per horse power hour; and no engine could be put to more trying service, for nearly 16 per cent. of the power used on a round trip is used in getting up headway at stations.

As it is now, the locomotive appears to be more economical than the average non-condensing single engine, but if the locomotive is ever pushed hard by any other motive power it will be developed in the direction of compounding. We have already enough tests of compound locomotives to form a pretty distinct idea of the saving that can be effected. In the series of experiments first tried in Russia, several years ago, to determine the efficiency of a compound

locomotive, the average of the results obtained shows the horse power hour was obtained with the evaporation of a little less than twenty five lbs. of water. The indicated horse power ranged from 160 to 260, and the mean saving in steam over an ordinary locomotive was 20 per cent. Some of the experiments gave the horse power hour on less than twenty-three lbs. of water. Reports from compound engines tried in India are not quite so favorable, the economy in fuel being only 13 per cent. A long series of tests of the Von Borries compound locomotives in Germany gave an average economy in fuel of 16 per cent., so that on the whole, we must conclude that in the matter of efficiency the compound locomotive gives about the same results as any other compound non-condensing engine.

It would appear then that the saving of fuel effected in the electric system would practically be that due to the difference between condensing and non-condensing engines. The saving in fuel would probably be about one-half. The saving in employes would be comparatively small; two or three men would be required to operate each power station.

The margin of economy, therefore, between a long distance electric system and locomotives, appears to be just about enough to balance the losses in the transformation in the electric system. This latter, however, has two additional advantages that tend to economy. In the first place, a somewhat cheaper grade of coal can be used with a stationary engine, because better firing is possible. In the second place, an electric locomotive would have a decided advantage in the matter of weight efficiency, which insures a slight economy in power. I should say that electric locomotives of the power we have been considering, would weigh from 30 to 50 per cent. less than an ordinary locomotive with its tenders. One instinctively asks, if this lighter weight does not mean decreased tractional power? And hence does it not work to the disadvantage of the electric locomotive? This opens the question of the effect of using the rail return for the current which supplies power. Most of those who have studied the subject, think that the adhesion is somewhat greatly increased by the passage of the current from the wheel to the rail. So far as I am aware there are no experiments under anything like working conditions, which give us a definite idea of the facts. That the general opinion is well founded, I have little doubt, and in looking over some of my note books, I have found some experimental evidence. This was a fact well known, I presume, to others who have experimented on electric cars, that the ratio between the power required to start a car and that required to keep it in motion, is quite out of the proportion with the results one would expect, judging from dynamometer tests on ordinary street cars. I am of the opinion that the increase in adhesion, even under ordinary working conditions, is very considerable. Where very heavy currents are used, we know, from actual experiment, that such is the case, as has been shown by Mr. Ries.

This naturally raises the question as to the possibility of reaching very high speeds by the use of electric locomotives. Of course, in any case, increased speed means greatly increased power, and the question then becomes one of comparative weight, efficiency and adhesion; this comparison is certainly to the advantage of the electric motor, but we must remember that the limitations upon railway speeds to-day are not those set by mechanical difficulties, but considerations of safety and economy, and these do not change in any marked degree with a change in the motive power. If it would pay to run railroad trains at an average speed of a mile a minute, it would have been done long ago, and there is no reason to expect that the use of electricity would quicken the running time, unless the public demanded it and felt quite safe and reassured at the prospect of being hurled through space at the rate of 100 miles per hour or thereabouts. If there ever should be an imperative demand for very high speed I think that one may roughly estimate that the use of electricity would nearly double the speeds now in use, but the question of these very high speeds is purely a question of dollars and cents, for as a rule very fast trains are not found to pay particularly well. In the case of a suburban road, the saving in wages would be considerable, since one power station would suffice for the whole system, and the same is true, of course, of any large system operated from a single station. The Illinois Central suburban trains, for example, might run electrically with great advantage to the public, and probably to the company. Smaller and more frequent trains would work wonders in the suburban traffic, and the absence of smoke and dust would be a blessing to residents along the lake front.

I have been considering up to the present the sort of railroad work most unfavorable to electricity, that is, general railroad work over long distances. There are, however, certain cases in which even now electricity could be employed to a great advantage. For example, take railway lines between neighboring cities, where the passenger traffic is large and frequent trains are run. If there were two competing roads, one operated by electricity and the other by steam, I should expect at least 50 per cent. more travel on the electric road by reason of its freedom from dirt and smoke, and attendant inconveniences. The same, I think, would be true in the case of very many suburban roads, and these cases where the distances are comparatively short, I should expect lessened running expenses by the use of electricity. More especially would this be true if electric braking should ever be put into successful use; up to the present, however, it has been one of the things very beautiful in theory and attractive in experiment, but which no one has cared to attempt employing.

The case, however, where an electric system would work to the very best advantage is the elevated railroad. In such a case we have a compact system which could be supplied from a single power station in the most direct and economical way. The damage to neighboring property would be enormously lessened, and the present objections to an elevated system would be in a great measure removed. Of the success and economy of an elevated electric system there can be no reasonable doubt, and I would

go so far as to say, that in view of what can be accomplished by electricity, there is no reasonable excuse for permitting the use of ordinary locomotives on an elevated system. The question has never been properly agitated, but if it were, I can see but one possible result. The difficulties of running an elevated system by electricity are immensely less than those encountered in the operation of a great street car system, like that in Boston. In particular, the bugaboo of electric railroad men, repairs, would dwindle into insignificance; for, lifted from the dirt and mud of the street, an electric motor can readily be given such care as would reduce the repairs to a comparatively small figure.

Let us look into the gain that could be made by using electricity on an elevated road. It is, I think, a peculiarly favorable case, and we fortunately have the facts and figures at hand to determine its probable advantages. I will put aside for the moment everything except considerations of economy and running expenses, and I will turn to the New York elevated system for our facts.

The locomotives on the Manhattan railroad work under conditions anything but favorable to economy. They are on duty twenty hours per day, and of that time steam is admitted into the cylinder but six hours. The full horse power of the engine is 185, the mean horse power is said to be seventy and three-tenths; as a natural result of this, the coal consumption is high, being six and two-tenths lbs. per horse power hour. Now let us count the cost of fuel for each engine, and we shall have an average consumption of 435 lbs. of coal per hour. What coal consumption will be required to furnish seventy and three-tenths horse power mechanical on an electric system of distribution? In the first place we shall have the advantage of being able to use triple expansion condensing engines, and the corresponding coal consumption is about two lbs. per horse power hour. This would mean something like fifteen lbs. of water, certainly a reasonable figure. I shall allow 125 indicated horse power to furnish the seventy and three-tenths horse power required. This certainly is a liberal estimate meaning, as it does, an efficiency of only 56 per cent. from engine to car. This allows 90 per cent. efficiency for the dynamos, 90 per cent. efficiency for the line, and a little less than 70 per cent. commercial efficiency for the motors. This estimate is surely within safe limits, for if 90 per cent. is high for the line, surely 70 is low for the large motors, for at least this figure can be secured with a good street car motor.

Against, then, 435 lbs. per hour of coal required for the locomotive, we have 250 lbs. of coal per hour required to furnish the same power to the train electrically. And besides, the coal required for the locomotives is of a higher grade than that which would be used with a stationary engine, for it has been found best on these small locomotives to use a rather high grade of coal, whereas I have estimated the coal consumption for the stationary engine on the basis of a cheap coal, having an evaporative power of seven to seven and one-half lbs. of water per lb. of coal, and costing less than \$2.00 per ton in New York. Bearing in mind these figures, we see that the saving of coal must be considerable. The coal for the New York elevated road cost over \$700,000 per year. In view of the facts I have just set forth, I think on a conservative estimate, there will be a saving of \$400,000 per year by generating the power at the central station and distributing it electrically. This means lessening the operating expenses of the system by a very perceptible amount. Aside from the bare cost of fuel, the saving and handling of coal and ashes and furnishing water, will be no small item.

But even this great saving in operating expenses would not represent the saving which could be effected in operating a new elevated road by electricity. In the first place the damage to adjoining property would be enormously lessened by avoiding the noise, smoke and dirt of a locomotive. In fact, I believe that the saving in the cost of right of way would go far toward paying the expenses of equipping the road electrically. But this is not all. The use of locomotives makes necessary the use of larger train units. Larger train units mean, on the score of safety, running at rather less frequent intervals, and that in turn means giving up that as yet unrealized ideal of rapid transit, small trains running at such frequent intervals that it would never be worth while to run for one.

With lighter trains running at more frequent intervals, the strain on the supporting structure would be greatly lessened and the load more uniformly distributed, consequently the whole structure would be made light in appearance and reality, costing considerably less and being far less unsightly than those now in use.

Taking this into account it seems very probable that an electric elevated road could be built and equipped at a less cost than if it were to be operated by steam. The great ease with which small train units are handled on an electric system, should of itself be the strongest possible recommendation.

The question naturally arises, how could we equip an electric elevated road so as to secure the best results? This opens a wide field for discussion, and I can only enter it to give you my own personal views on some point which might be of advantage. Personally I do not believe in the single car as the unit of transportation. Firstly, that it increases the cost of equipment enormously, and secondly, because in running at a high speed it is inconvenient to run independent cars as close together as is necessary to secure proper accommodation. On the other hand, I do not believe in long and heavy trains. The necessary speed for the service being known, I think the general result would be obtained by using as many small trains as could be conveniently operated at the required speed. By small trains, I mean trains consisting of a motor car and say two or three light passenger coaches. I am a firm believer in a motor car, rather than motors placed under each car, for the very practical reason that motors isolated and placed in a separate car can be given immensely better care than would ever be received by a motor hidden beneath ordinary cars. If we are to secure the minimum of repairs and the



fewest possible number of break downs, I think it must be done by giving the motors steady and careful attention, and I believe this end can be reached by a separate motor car, so constructed that the motors and all the running gear can be under constant inspection. I see no objection to a composite motor car containing compartments for passengers, provided the above conditions are fulfilled, but I should hesitate to use on a system requiring high speed and very frequent trains, motors so placed that they cannot readily and immediately be reached in case of accident. As to electrical equipment, I think the problem is not particularly difficult. The size of motor to be used must be regulated by the train unit proposed. Perhaps for the unit suggested, two thirty horse power motors would answer as well as anything. It should be remembered that isolated, as the elevated tracks would be, it would be practicable and safe to use the higher potentials than is customary in ordinary street railroad practice.

The distributing conductors on an elevated system could be arranged whatever way would prove most convenient, quite irrespective of the present limitations. Neither would the amount of copper required be at all prohibitory. For example take ten miles of double track with the power station somewhere near the middle point. The wiring would of course correspond with the number of trains to be run, but working on a three wire system, with track and balance circuit, the equivalent of two copper rods one inch in diameter, would serve to handle a very large equipment and still give a high efficiency for the line. The weight of this conductor would be about sixteen tons per mile of double track, certainly not a prohibitory amount. By using two power stations this amount of copper could be reduced to one fourth. If the amount should still seem too large another interesting possibility appears. Would it not be possible to operate an automatic block system of series distribution? By dividing the double track into sections and supplying these from one or more power stations, it would be possible to avoid most of the difficulties of series distribution without sacrificing much in the way of line efficiency. We must remember that in this connection the principle of electrical braking is easier to apply on such a system than it is on a system of distribution at a constant potential as ordinarily practiced. Electrical braking has not been put into operation in a commercial way, but some competent authorities have estimated that a saving from its use might be as great as 40 per cent. in power required. Such saving would be well worth effecting, even if it were less than the above amount, unless there should be good mechanical reasons to the contrary, and inasmuch as working upon the block system would do away with many of the objections to series traction I think, to say the least, this line of operation is well worth careful investigation. In a great city like this, rapid transit is becoming more and more a necessity, and now before great investments have been made, is the time of all others to try to forecast the future, and see to it that the rapid transit to be given the city is the very best that modern enterprise can secure. I think we may feel sure, from what has already been done, that we need have no fear of the economy of an electric elevated system, and there is no good reason therefore why it should not be tried. People do not look forward with pleasure to having a smoking, hissing, locomotive spluttering by their front windows, nor do they contemplate with delight its train of cinders, ashes and grease deposited on the heads of the long suffering passers by. Property owners do not enjoy the prospect of such a noisy, dirty neighbor as an elevated road operated with locomotives is even at its best, and there is no reason why they should be called upon to tolerate the abomination, when nearly all the objectionable features can be removed, not by sacrificing anything, but by gaining at almost every point.

The reform cannot be delayed; it is only a question of who will be the first to display the necessary enterprise and energy, and give this city a system of rapid transit suited to its needs and to the age in which we live.

To sum up, I would state my firm conviction that the most of us will live to see electricity come into very extensive use in general railroad work, certainly for special and suburban roads, possibly for long through lines.

## The Steam Engine.

BY FRED E. SICKLES.

(Continued from page 96.)

In cases where the trip cut off is required to act at all points of the stroke it is best to use it in connection with the patent of Sept. 19, 1845, granted to the speaker, which has been variously termed "Independent Motion," "Universal Motion," etc., as it works the trip at any point of the stroke of the engine. This invention is in use on the steamers of the Fall River Line running on the route between New York and Boston, and many other vessels. It has lately been used on some boats on the Western rivers under various names. When the trip is worked by the valve motion, as shown in the patent of May 20, 1842, it is best to limit the motion of the tripping piece so that the cut-off will always act and not allow the steam to follow the full stroke by the excessive vibration of the governor.

The speed at which a trip cut off can be made to work will depend somewhat upon the arrangement of the mechanism. The lighter the parts involved in the motion, the more rapidly they can be made to work with ease. A large steam engine with large heavy valves has been made to work at the rate of 120 revolutions per minute, and indeed it would be hazardous to limit the speed at which a trip cut-off can be made to work, as, with the proper closing force and the proper absorbing vessel for the momentum, the speed of closing can be carried far beyond anything yet in use. But the cut-off is only a part of the engine. The motion of the steam valve in opening to work smoothly with the greatest power should be such that, while it moves, to give only a slight opening at the beginning, so as to gradually apply the steam as the engine passes the

center, this gradual opening should change into a rapid one followed by a rapid motion of the valve in cutting off the steam. The motion of the exhaust valves should be rapid in opening and rapid in closing, and one exhaust valve can open before the other closes, providing some means are secured to gradually apply the steam to the engine as it crosses the center. But in practice there are only a few instances in which this gradual application of the steam has been used. I will mention one case in the speaker's practice. The Steamer Pilgrim, having an engine with a diameter of cylinder of 110 inches and a stroke of 14 feet, carrying pressure of steam as high as 45 pounds per square inch, was required to be altered from a Stevens valve gear to a trip cut-off, and it was necessary to retain the faulty steam connection between the boiler and the cylinder and the faulty surface condenser and do the best the circumstances would permit. To remedy the faulty condenser in part, the exhaust valves were arranged so that one was open  $4\frac{1}{2}$  inches before the other closed, to afford the greatest possible time in which to condense the steam from the cylinder, and thus prevent any attempt at cushioning. It was necessary in working the steam valves of the new arrangement to so graduate their opening at the beginning of the stroke as to avoid any shock or jar that might come upon the engine by reason of the application of steam. As the valve gear was very heavy, involving tons of metal, the spring of these parts would tend to increase the sudden admission of steam, notwithstanding any gradual movement that might be attempted upon them. A plan was resorted to of opening the steam valve an adjustable distance, say  $\frac{1}{8}$  of an inch, and then stopping all further motion for a short time so that the spring of the heavy parts of the machinery should not act by their elasticity to increase the opening. After the engine had crossed the center the further opening of the valve was commenced and continued until the cut-off acted. The entire distance of opening both steam and exhaust valves was  $6\frac{1}{2}$  inches in this case. The indicator card still showed a defective condenser and defective steam connection, and it also showed what appeared to be a slight cushioning; but this appearance was deceptive, as the real cause was, the steam passed around from one side of the piston to the other as one exhaust valve opened rapidly before the other closed, and the slight delay occasioned by the use of the faulty condenser increased this apparent cushioning upon the card. There could be no cushioning, because both exhaust valves were open, until the piston arrived at each end of its stroke. But the problem of applying to an engine of this size in the hull of a steamer without creating a jar had to be solved and this was done, as before stated, by a careful adjustment of the steam valves in opening so as not to apply the whole of the pressure at once. The first admission of steam in this case is marked by the sound of a squeal, indicating wire-drawing at the first motion of the steam valves. The indicator card shows a curved line on the admission end, proving the gradual application of steam. This was the best that could be done under the circumstances, and it was found effective in making the engine work smoothly while the main connections were quite loose, and saved a large amount of fuel by the rapid cut-off. No doubt she may still be seen running in the summer between New York and Boston on the Fall River Line.

Any inquiring mechanic who desires to test the question of whether it is possible to prevent a jar by the gradual admission of steam, can do it in this way. He may put a very small valve upon one end of the cylinder of a steam engine and make arrangement to give it an opening and closing motion. Then, if he will set this engine to pound on both centers and subsequently adjust the opening of this valve he will find that it will take the pound off of one center, in which it admits steam, by properly adjusting it, and in this way be convinced of the efficacy of the gradual application of steam to prevent a concussion upon a center. Mechanics as a rule must depend upon themselves. The assertion of a fact by another is no proof to them, and hence I have stated a way in which they can satisfy themselves of the efficacy of the gradual application of steam. There are, however many forms of valves in which this method of the gradual application of steam can not be well embodied without too much complication, and for very large engines it might be well to apply separate small valves to ease the engine on the center.

In most cases dependence has been placed upon what is termed cushioning to make the engine work smoothly, by shutting the exhausts before the completion of the stroke and allowing the steam yet remaining in the cylinder to be compressed. It may be said that all high speed engines of the present day use this plan to avoid pounding on the center. Locomotives and high speed stationary engines depend upon the compression of steam to avoid a pound in the reciprocating parts. This compression necessarily absorbs a certain portion of the power of an engine, but it can be relied upon to secure smooth working. The price of coal, the interest upon money, and the cost of reliable attendance are to be considered in determining the best plan as a money consideration. This last remark is true in considering the construction of every part of the engine. A perfect valve has not yet been made, a perfect cylinder has not yet been made, a perfect packing of cylinder has not yet been made, a perfect valve motion has not yet been made, etc., etc. The packing of the piston should be such as that it will work without friction, automatically adjust itself to the wear and to the irregularities in the bore of the cylinder, and also to the different temperatures of the piston on the cylinder upon first starting the engine, and it must be tight. If the rings are made, as the speaker has sometimes made them, with an adjustable catch to hold them from being thrust out by a spring so hard against the cylinder that the steam could not force them back, then as soon as any wear takes place, this catch will act to prevent the rings from following out the wear, and thus a leak will be created. Great care is required to manage an adjustable catch. Now, if the catch is not used and some force is applied to keep the

rings out against the cylinder as is usually the case, then if the steam leaks by the rings and gets between the cylinder and rings, it may force the rings back and create a leak. If the spring is set so as to hold the rings out against the cylinder, and to resist the tendency of the pressure of the steam to force them back then a great friction will be encountered between the rings and cylinder and if the steam should pass behind the rings, it will force them out against the cylinder with additional pressure and thus add to the friction. If an arrangement such as has been made is used to present a smaller area to the steam behind the rings, than exists on the face of the rings, then the steam in passing behind the rings and forcing them out, may be met by the steam which has passed down between the rings and cylinder, this steam acting upon a greater area, may overcome the steam forcing them out and forcing the rings back, thus creating a leak. Indeed it may be said that mechanics are almost in despair of producing a perfect piston packing. They have turned grooves in the piston, and in these grooves have inserted other packing rings, but after all the difficulty exists in that the steam is liable to force them in or out. If they are forced out it creates undue friction. If they are forced in, a leak is permitted. If any attempt is made to have a fixed ring, in the sense of preventing it from being made either larger or smaller, then the danger of more rapid expansion of the piston is met upon starting the engine. The difficulty of obtaining proper adjustment with ordinary attendance is met, so that a perfect piston, one that is automatic in its adjustment and comparatively frictionless and tight, as before stated, has yet to be made; all parts of the engine are imperfect. A realization of the imperfection of any machine may lead to the way to make an improvement upon it; it is therefore instructive to search for defects in the steam engine.

A perfect lubricating arrangement for the journals, one that can be relied upon in all cases, has yet to be made; of all the various forms of valves each has its particular disadvantage, and there yet remains to the inventor a wide scope in which to engage his efforts. But in determining upon any plan, he is met at once by the consideration that a plan that might be good in one place would not be good in another because of the difference in the interest on money and the price of fuel; and perhaps in another place the difference in the price of fuel and the price of efficient attendance. In another place the difficulty of securing proper repairs, as for instance, an engine in the mining regions, may be met. So it is quite impossible to give any specific directions for the construction of what might be called a universal steam engine. Perhaps in some future day some one will make a steam engine which will secure fully, economy in construction, economy in regard to fuel and efficient attendance, but certainly no such machine has yet been made.

As the cost of efficient attendance diminishes, probably an increase of efficiency of the steam engine can be secured. A machine that will work well in the hands of one person will sometimes prove a failure in the hands of another, and a construction engineer is constantly harassed by the question: "Who is to take care of and run this engine which I am now planning?" "and how far can I rely upon efficient attendance?" and as often as he decides these questions he decides to some extent the character of the engine which he considers best for the purpose. Users of steam engines naturally desire to have their engines so constructed that they need not continue in their employ any particular engineer, but can change employes without danger to the success of their engines. Users consider this fact in determining the kind of engines to purchase.

A perfect governor for general adoption has not yet been made. All forms of governors in use depend for their action upon the change of speed of the engine, and when a small amount of steam is required to drive the engine, the governor must necessarily move faster to diminish the supply of steam, either when applied to a cut-off or to a throttle valve. When the governor receives the impulse to run faster, the working parts of the governor are restrained to some extent by the force transmitted through them to increase its speed, and hence at that moment it is not as free to act as it would be if no such resisting friction were applied to it, and yet at that very time the governor is required to move and the result is it does not move at first, until sufficient additional speed has been imparted to it to overcome the friction created by applying the force necessary to create this additional speed; and when the governor moves, the friction having been diminished by reason of the driving force being less, it has a tendency to move freely and shut off the steam to too great an extent. Various appliances have been made to correct this by preventing the governor from moving rapidly in any case, but when this is done the governor may not move with sufficient rapidity to check the engine when the load is suddenly removed. Then again the parts which have to be moved have more or less friction in themselves, and the greater this friction the greater the tendency to obstruct the free movement of the governor. We see in practice that unless a comparatively large amount of momentum is secured, either by high speed or by a large fly wheel, there is a great tendency of vibration in the motion above and below the required point. To overcome this the speaker at one time combined a governor arranged to receive its impulse through a driving arm and roller, so as not to materially impair its sensitiveness, and then this governor acted upon the differential motion patented by the speaker, which in fact separated all the force necessary to work the parts operating on the governor, and thus the governor was as sensitive as the pendulum. But this arrangement was too delicate for ordinary attendants and was only resorted to in this case because of the peculiar surrounding circumstances. The patent on this arrangement has expired. It may come into use in some future time when the advantages of a very accurate running engine are more appreciated, and when the cost of efficient superintendence is less than at present. I may mention that so perfect was this engine that on one occasion when the driving belt



broke the engine continued to run so nearly exactly on speed that the difference could not be noticed. It is possible to make an engine do this, but it requires great care in the construction of the parts of the governor and the differential motion and power cylinder attached to it. It also requires that all the incidental slack that may be in the parts between the first motion of the governor and its final application through the differential motion and power cylinder shall be provided against, by either a weight or a spring which shall hold all this slack constantly in one direction, for this slight slack will still affect the action of the governor if it is allowed to act irregularly. Perhaps the best practical solution of the governor question at present, is to provide a very large governor, running at high speed, so that a very little change in the motion of the governor will effect a very great change in the amount of steam applied to the engine; then if this governor is driven by arms which bear against rollers inserted in the balls or weights in the case of centrifugal governors so that these arms drive the balls or weights faster or slower through the interposition of a delicately made steel roller, that permits the balls or weights to move freely, when any additional force is applied to them, a much greater accuracy of regulation can be obtained than is usually found in practice, provided that care is taken that all parts necessary to be moved to control the motion wheel have very little friction. It would be very difficult to explain the whole matter without drawings, but I have endeavored to state the principles, which can, of course, be carried out by different mechanics. Governors for steam engines have been made in various ways, but nearly all of the kind which I am about to allude to have passed out of use, and I can best describe them in a few words by stating the principle upon which they were built, and leaving the special designs out of the case. One form of governor was made by first generating a uniform motion, and this uniform motion was generated in different ways by different persons. One used a uniform motion acting upon a uniform resistance; another used a varying force upon a varying resistance and secured a nearly uniform motion by a governor; then this uniform motion thus generated was applied to control the motion of the engine by interposing between the uniform motion and motion of the engine a lever or cam so arranged that the steam engine varying this lever or cam in shifting its position would apply more or less steam, and thus the engine was controlled to run with the speed of this independent uniform motion. Another form of governor was made on the principle of moving a body in a fluid, and as the resistance increased by reason of the increased velocity of the steam engine, a spring or weight was moved and by its motion the admission of steam was adjusted to control the speed. But it is questionable whether it is not the best principle to have what amounts to a substantially powerful governor, as before stated, so that a very slight motion of this governor will be sufficient to regulate the admission of steam to control the speed of the engine; care being taken to secure almost frictionless action of the governor in its movements, and to separate any load involved in the action of the parts to control the steam so that the governor may act as nearly as may be like a pendulum beating time. And, indeed, the point to be reached as before stated, is to cause the governor to be as sensitive as a pendulum of a clock, and to be free from disturbing influences.

Governors have been applied to cut-offs from the early part of this century; as early as 1812. As the trip cut-off required but little power to change the rate of expansion, it was well adapted to be operated by the governor, and its frequent use for that purpose has stimulated users of the different kinds of cut-offs to connect them to the governor with more frequency than was the general custom before the trip cut-off was invented. Almost any form of cut-off can be controlled by the governor, provided changing the cut-off does not bring too great a disturbing force upon the governor.

In regard to the steam engine of the future, if a metal is found that will enable steam of, say, 1,000 degrees to be used and the escaping heat from the first boiler to be used in evaporating water to feed a second engine at 500 degrees, and then to a third engine that will make the draft by drawing the heated products of combustion through water whose evaporation will supply a working cylinder that derives its power by receiving the steam below the atmospheric pressure and expands it to the lowest effective limit before discharging into a condenser,—then we will have a combination using much less water per horse power than any engine yet made; but it does not follow that such an engine will be the most economical, as that will depend upon the interest charged for the use of money and the price of fuel, as it would cost more per horse power to build such an engine than one working under ordinary conditions. With money at 6 per cent. per annum and the cost of fuel to evaporate one ton of water at \$1, a certain plan would be advisable. Again, with the money at 3 per cent. per annum and the cost of fuel to evaporate one ton of water at 50 cents, the same plan would be good, but as the cost of money and the cost of evaporating water change relatively, the best plan for economy in a steam engine would necessarily change to obtain the most economical result in the use of money. The cost of room for the plant and the cost of water for condensation, together with other contingencies, must be considered in any plan for a steam engine that is to be adapted to the surrounding circumstances under which it may be required to work.

The cultivated human eye and ear are wonderful natural indicators to determine the working of many parts of a steam engine. By watching any moving part of the engine and listening to the sound of the steam in the steam pipe, a good idea can be formed of the point of cut-off. By a closer attention to the peculiar sound of the rushing steam, the efficiency of the cut-off can be partially determined. By listening to the sound of the exhaust and watching the crank-pin, a good idea can be formed of the lead; then by a closer attention to the peculiar sound of the exhaust, such as the time during which it can be heard, a fair idea can be

formed of the exhaust line as it will appear upon the indicator card in the case. By a close attention to the motion of the reciprocating parts of the engine in crossing the center, the effective lead on the steam valve can be ascertained, particularly if the engine is not set to cushion largely on the exhaust.

The human touch will reveal relative motion in contiguous parts of machinery that is beyond detection by the eye or ear; as, by placing a finger on two pieces that are apparently firmly in contact, a motion will sometimes be felt that is not visible.

By cultivating the eye and ear and human touch to help in judging machinery, every engineer will be filled with a reverence for the marvelous powers of the human machine of which he is master.

Some blind persons can by the sense of touch in their tongue guide a thread into the eye of a needle. Some watchmakers can ascertain if a watch is running accurately within reasonable limit by holding the watch to their ear and at the same time watching the vibration of the pendulum of a standard clock. The carefully trained pilot in a fog or dark night will depend upon his hearing to tell him when he is approaching an invisible object of any considerable size which projects above the water, as he will instantly notice a change of echo of the noise made by his vessel. Some engineers, trained to the sound of their engine, will notice a very slight difference in the working of any part by the change of sound, even when they are engaged in other work and apparently not listening to any noise.

To speak upon the steam engine generally is to endeavor to embrace a subject that has almost infinite aspects and embodying innumerable plans of different men with fertile imaginations and ingenuity. The speaker has only endeavored to present a few views of the case in a short statement. The subject is too vast for complete treatment, and the life of an ingenious inventor can be occupied with efforts to improve only one part of a steam engine, and at the end find a vast space is left for further improvement.

The use of words to describe machinery, without the aid of drawings, must at present be unsatisfactory, as all of these words have meanings attached to them formed during a former civilization in which but little machinery was used, and the special sense in which they are necessarily employed in this statement must be understood before the intended meaning can be apprehended. A knowledge of the ancient and modern languages will afford no certain assistance in determining the meaning of words as used by mechanics, in the absence of knowledge of the special meanings attached to them in describing details or mechanical operations. The dictionary depends mainly upon the leading authors for the meaning of these words, and probably they only knew them as associated with ideas entirely outside of all engineering or mechanical connections. When in the progress of improvements, a complete dictionary is established, giving the meaning attached to words as applied by mechanics or engineers in describing machinery, it will then be easier to describe by the use of words alone any mechanical operation so as to be more readily understood. At present it is like taking a cold chisel to do the duty of a screw-wrench in many cases when, employing words to describe machinery. In the decisions in the patent cases before the court it has been wisely held that every patent is to be construed as meaning what is to be gathered from taking the drawings and words together, or, in other words, each patent furnishes its own dictionary. And it is reasonable to assume that the words the speaker has used in an effort to describe some parts of the steam engine will be taken to mean differently to some extent, by different engineers or mechanics.

It is with some regret that the speaker is obliged to consider what he has stated as necessarily unsatisfactory, the pressure of professional engagements having prevented a careful preparation. A conference like this is well adapted to bring out facts, when, by the exchanging of views on various points, a much better understanding of the opinions of members can be secured for the benefit of themselves and all other interested parties.

### Electric Motors vs. Steam Locomotives.\*

BY JOHN C. HENRY.

In a paper read by Dr. Louis Bell before the Chicago Electric Club, and published in the June issue of the "Gazette" on the subject of electric railways the popular opinion that steam locomotives are wasteful engines is, in a measure, combated by reported tests and comparisons. I cannot help thinking that Dr. Bell's conclusions are erroneous in this respect, and will give some reasons for this opinion.

I have no wish to disparage the work of the engineers who developed the locomotive. To me they move to-day as living monuments to nameless thousands of students and mechanics whose limbs have failed and whose brains have been worn out in their efforts to improve this almost human machine. Did it ever occur to the reader to estimate at what cost the locomotive of to-day has been developed? Consider the thousands of lives that have been lost in railroad accidents, each of which developed perhaps a single fact that a certain portion of the machine was faulty or weak, or that metal of a certain shape or in a certain position would deteriorate rapidly, that one portion was too heavy, and another too light.

Is it any wonder that the novice who carries his wooden model into the presence of the railroad official usually finds that gentleman averse to changes, and apparently disinterested, or "cranky," and retires with the opinion that no one outside of the "ring" can have his devices or improvements adopted. Every country section has such working individuals; add to these vast numbers the thousands employed with the locomotive, all with the chief aim as their greatest desire to improve and surpass their fellows, would the estimate that the present development of the locomotive had cost 100,000 lives be unreasonable? I think not,

\* Electrical Engineer.

Such considerations raise the question, Is it worth the price? If the Emperor of China's objection to the introduction of the steam horse in his domains are based on any such considerations, it is not wholly without reason; but science knows no sentiment. Our present existence and future welfare depend upon the husbanding of energy. The time will come when it will be exhausted, whether physical, mental or mechanical. With the latter I will attempt to deal. The point I wish to prove is that notwithstanding this immense cost and the improvements suggested by nearly seventy years' experience, the popular locomotive of to-day is an unscientific, extravagant machine, and that on the points of economy, ease of manipulation and safety, it cannot compare with the new-born electric motor, and is distanced by the stationary engine.

To deal with the subject properly, comparisons must be made and weaknesses pointed out. Stationary engines have automatic cut offs; locomotives depend upon manually operated ones, which are necessarily intermittent and much less sensitive to varying conditions than a spring would be to a changing load. Poor regulation means a waste of steam. Stationary engines have balanced valves; the steam pressure against them is equalized and they consequently move freely. Locomotives, owing to their peculiar construction, require the valves to be on top of the cylinders, which precludes the use of anything but slide valves, which have the full weight of the steam pressure bearing against their movement. Owing to the compact requirements, locomotive boilers have much less beating surface than stationary boilers; this necessitates the use of a forced draught, which means that the larger portion of the heat passes out of the stack, the boiler absorbing the most intense heat only. Stationary boilers are usually covered with several courses of brick to confine the heat. This would be impracticable on a locomotive; they are usually covered with thin wood lagging, the detrimental effects from which in varying temperatures are great. I have frequently seen locomotives lose steam at the rate of about a pound per second when passing through snow-drifts. The loss of fuel is very considerable in bad weather or when running against the cold winds.

I question the correctness of the reported tests in Dr. Bell's paper; they seem as unreasonable as some I once made with an electric motor. It appeared to show an efficiency of 115 per cent. I have carefully watched the tests of some of the finest locomotives in the West. The best result I have ever known was a consumption of 8 pounds of coal to the horse power hour, and this was under the most favorable conditions. The same locomotive showed a consumption of over 20 pounds of coal to the horse power hour when working "down in the corner."

In the absence of other accurate data on this subject which I expected from the article referred to, I investigated the startling economical reports of the performance of the Elevated Railway locomotives. I found they consumed from 50 to 90 pounds of anthracite coal per mile, run with five coaches. Striking the average at 70 pounds, and estimating the average weight of the trains 250,000 pounds, to move this weight 100 miles would require an expenditure of but 276 horse power hours; dividing this into the amount of fuel actually consumed would show a consumption of 25 pounds of coal to the horse power hour. This estimate is based upon a perfectly level track, in good condition and no stops. The extra amount of energy lost in ascending grades is partially regained on the descent, and a certain proportion is lost by the car brakes. Some years ago Mr. Frank J. Sprague carefully investigated these losses, and, I think, placed them at about 40 per cent. of the total, which seems to be fair; this would leave the result that the New York Elevated Railway locomotives consumed, on the average, about 15 pounds of coal to the horse power developed per hour. We all know that stationary engines are on the market that will not consume over one-fifth of this amount of fuel for the same power developed.

There is much to be said in favor of the rotary movement of electric motors as opposed to the reciprocating steam engines. I am told that Mathias Baldwin, founder of the celebrated locomotive works, had the idea haunting him throughout his life, that the locomotive should have rotary engines. "Appleton's Applied Mechanics," under the head of "Steam Engines," has the following: "It has been said that there is scarcely an engineer of much experience who has not designed at least one rotary engine." The tendency of everything is to rotation; this is exhibited so prominently in nature and art that—pardon the thought—it may be the coming man will rotate.

In locomotives it has been found impracticable to put them in running balance. Suppose we were to support one on its frame, leaving the drivers free to revolve, and then open the throttle; the locomotive would immediately commence a rocking motion, and the tendency to leave the foundation would increase as the square of the speed.

Some years ago, Mr. McLoud, engineer of tests of the Pennsylvania Railroad Co., investigated this evil effect, and calculated that one of their latest designs of locomotives, when running at full speed, was delivering trip-hammer blows at each revolution of the drivers equal to the force of 60 tons. Among thoughtful railroad engineers the opinion was pretty general that the horrible Ashtabula Bridge railroad accident which caused about eighty deaths and sixty wounded was primarily due to this unscientific construction which is still in the steam locomotive, but absent in the electric motor.

Mr. John A. Brill, of Philadelphia, spent a number of days in Chicago last month.

Col. Thomas Lowry, of Minneapolis, and Mr. Peavey of Sioux City, Ia., have also been visiting the Garden City.

Mr. Turner, of the firm of Woodbridge & Turner, and Mr. T. P. Barry of New York, have been on western trips.



**Increasing Locomotive Traction by the use of Electricity.\***

BY C SELDEN.

Within a comparatively short time after the discovery of the electro-magnet by Professor Henry, scientific minds began to center upon the application of electricity and the use of magnets as a means or motive power; and the American inventor, Page, was, so far as our records show, the first person to practically demonstrate, upon anything like a large scale, that propulsion by means of electricity and magnetism was a possible thing.

He constructed a car and placed upon it a motor, by which it was propelled between Washington and Bladensburg, a distance of about seven miles, on the tracks of the Baltimore and Ohio Railroad Company. As the electricity was generated from a primary battery, however, it was soon determined that such a mode of locomotion was more expensive than that secured by steam, and the motor, therefore, was laid upon the shelf.

Later on, when the dynamo reached a high state of perfection, the infant electromotor suddenly sprang into the vigor of young manhood, and to-day we find Page's idea amplified and assisted by various improved devices, resulting in not only possible rapid locomotion comparatively, but affording a cheaper means than horse power.

When Page made his trial trip, the locomotive engine was not the machine which to-day thunders along drawing a train, at the rate of seventy-five miles per hour, but as the locomotive engine has been undergoing improvements from time to time, it has been apparent that a great proportion of the power generated by this machine, could not be utilized for the hauling of loads; and by reason of only partial combustion of fuel, loss by exhaust, and non adhesion to the rail, or lack of traction power, only a small percentage of its power was available for use.

In order to increase the adhesion of the locomotive to the rail, increased weight was placed upon the drivers; this increased weight necessitated an increase of furnace, boiler and steam capacities, and an increase of, say, one hundred per cent., only brought an appreciable increase of a small proportion.

From competent authorities on motive power, it has been determined that a locomotive, having a weight of 100,000 pounds, has a tractive power upon the rail, when in best condition, of but 25,000 pounds. And when the rail, by reason of the weather, is in a bad condition, the tractive power amounts to only about what an engine of 15,000 pounds weight should have. In other words, on good rail, by non-adhesion, the locomotive gives but twenty-five per cent., and on bad rail, but eighteen per cent of the power which, theoretically, should be had from it.

Efforts were made some fifteen years ago, by an Englishman named Wederman, to overcome the non adhesion, by winding the spokes of the driving wheels with wire, thus making a magnet of the wheel, with the view of, by magnetism, attracting the wheel to the rail, thus increasing the friction, and, thereby, the adhesion to the rail on the part of the locomotive. Having but a primary battery, it is plain to be seen that the results were so slight as not to be appreciable. Another objection, even had the dynamo been used, was that, in order to secure sufficient magnetism to be of benefit upon such an immense machine as a locomotive, the magnets would have to be very large, and the winding upon the spokes of the drivers would have necessitated a change in the construction of the engine, so that as the bobbin was being revolved by the wheels there would be room to clear the fire box on the inside and the side rods of the locomotive on the outside. This, of course, would render necessary a longer crank pin for the bars, and, being longer, it must necessarily be stouter in order to stand the increased leverage, so that a device of this character for the locomotive engine would not be economical, and would necessitate the reconstruction of all locomotives using it. This inventor filed patents in this country and several others followed in his footsteps, but nothing practical has yet been evolved from that method.

Elias E. Ries, an American inventor, secured letters patent upon his method of increasing the adhesion of the locomotive to the rail, by the use of electricity, and he took a wide departure from the path pursued by former inventors.

Mr. Ries proceeded upon the hypothesis, that an electric current of large volume, if properly employed, could be used to weld metals. Acting upon this theory, he proposes to arrange, upon a locomotive, a dynamo of sufficient power to be run by a small auxiliary engine, and to pass the current from the dynamo to the driving wheel of the engine, along the rail to the next driving wheel, through its axle and the other wheel to the other rail and back to the first driver, thence to the dynamo, thus making a local circuit, so to speak, which would travel with the locomotive, passing a current through the drivers and along the rail as indicated, and for this purpose, by a very simple method, he insulates one pair of the driving wheels.

By this means the inventor proposes to cause an "incipient weld" between the driving wheels and the rails. I say "incipient," because the wheels, being in motion, the weld, if any, is being made and broken by the revolution of the wheels, therefore a perfect weld is not obtained, nor, of course, would it be desirable except for brake purposes, as in descending a grade for instance.

If the theory advanced by Mr. Ries can be made a success, practically, it means a great many things to the railroad world. If by means of this invention the tractive power of a locomotive is increased, say, even twenty five per cent., it means ten additional cars on a forty-car train. It means a large gain in the hauling capacity on high grade railroads. It means increased speed for passenger trains. It means a saving, indirectly, of fuel; it means the employment of lighter locomotives to do the same amount of work as the heavier ones, thus being easier on the road bed and bridges; it means the mounting of grades that would not be considered as possible at the present time. All this,

\*Paper read before R. Tel. Sup's. Con., Niagara Falls, June 18th.

provided, that in practice, on a locomotive, the theories advanced shall hold good.

Through the kindness of the inventor I have borrowed, for this occasion, a model motor and a piece of track, which practically demonstrates, of course in a minor way, the correctness of his theory, and the more than probability that it may be applied upon a large scale.

As it would not be possible to secure a small engine propelled by steam with which to demonstrate the idea he employs this carriage, which, as you all see, is simply a small electric motor.

The motor is charged by means of one or two cells of battery, and the track (when greater adhesion is desired) is charged from another cell or two of battery. The track is charged in this instance, instead of the motor carrying the power and charge for itself on account of its smallness, and the weight which it would have to carry, as you can easily see, but the application is in effect the same as the other method.

You will note that one of the poles of the battery is connected to one rail and the other pole to the other rail; therefore, when the motor wheels are on this track, if a current be flowing along the rails, it will pass from the rail on one side, through the motor wheels, along the axle, through the wheels on the other side to the rail, thence to the other pole of the battery completing the circuit, just as it is proposed to do by means of a dynamo on an engine.

To show that this circuit, passing in that direction, does not enter into the motor, I now make the connection. You notice that the motor remains quiet, thus proving that if any increase is hereafter shown in the power of this motor, that increase does not come by reason of increasing the power of the motor, by increasing the electro-motive force, but must come from the fact that there is an incipient welding or increase of adhesion, between the wheels of the motor and the rails, and that, therefore, its "torque" or "bight" has been so much increased as to enable the motor to have, as it were, an immovable fulcrum for its leverage, instead of one which is always slipping, as can be shown in the other case.

By making a twenty per cent grade, which you will, of course, remember is twenty feet in the hundred, being over one thousand feet to the mile—and not usual—the motor is powerless to ascend and it remains at the bottom of the grade with its wheels revolving and slipping, unable to move.

If you now apply the circuit, so as to cause an incipient welding between the wheels and the rails, the motor mounts the grade.

Another experiment—reduce the track to a level, fasten the motor to a Fairbank spring balance, start the motor and observe what strength it displays. In other words, what is the amount of its pull in weight? The result as shown upon the scale is, say, between five and six ounces. Watch the motor when the traction circuit is made and the result is twenty four ounces—an increase of almost five hundred per cent.

These results are shown upon a rail which is dry and in the best possible condition for mechanical traction—and just here it occurs to me, and I can picture in my mind, the woe-begone look on the face of the woman who is said to have gotten even with the railroad company, had she attempted to do so in like manner with an engine equipped with this device and in successful operation. As the story goes, a woman living alongside the railroad, lost her cow, it having been struck by an engine; and as is customary in such cases this \$30 cow became worth \$150. When the papers in the claim reached the railroad company, naturally there was correspondence to and fro and delay in settlement of the claim. The woman's property happened to be adjacent a very bad curve, and as many of the trains had to use sand, she concluded that as the railroad company did not intend to accede to her demand, and was giving her a great deal of trouble, that it was no more than fair that she should do the same for them. It was at that time of the year when people in the country make soft soap, and with a goodly kettle-full of it, she proceeded to lather the track with it for a quarter of a mile. Prior to that, limited trains had passed by without stopping at the station near her, let alone doing her the honor of stopping at her house, but they all stopped there that day and the following day, and again next day until the cause was discovered and the woman taken into custody.

If we take a piece of soap and soap the track—and in order to make it as soft as possible, I will put water on it besides—it becomes as slick as a toboggan slide, and the motor will not proceed. But if the traction circuit is applied, away she goes—soap or no soap.

For fear, perchance, that this soap has dried, and has really become as sand upon the track, you may oil it. You will note that the oil makes no difference to the motor. This simply goes to prove, to my mind, that irrespective of the condition of the weather, be it rain or snow, the device, if practical in dry weather, is equally so on a bad rail; and being equally so, is a much greater help, proportionately, when the rail is in perfect condition.

Another feature of this invention is that it is not necessary to keep the current flowing all the time, unless you need it, but when you stop the train and want to start it your locomotive, at that time, not being in motion, a more perfect weld is obtained thus enabling you to start at once, without slipping, and after you have gotten your train under headway, your current, if desired, may be switched off. So much for the pulling power and so much for the motor.

To show the effect of this track circuit lift one end of the track and place across it a small iron bar, which is free to move from the top to the bottom of the grade, and the bar may be pushed or allowed to slide by its own weight with the same result. You will see that it does not reach the bottom of the grade. On the other hand you can stop it at will, for the instant the circuit is applied the bar stops. And you will note that you can take hold of the bar and shake the track with it; in fact, lift it, thus proving conclusively that with the circuit as used through this track,

the motor operates exactly as it does with the bar, and that the ability of this motor to climb grades, and the increase of its pulling capacity is due entirely to the tractive results of incipient welding between the wheels and the rails.

There is no doubt of what the model performs. There is no doubt that the theory is correct, but practical tests alone will determine whether or not sufficient power can be had from a proper dynamo and auxiliary engine, to show even twenty five per cent. of such increase upon a locomotive as has been shown here. If it can, then great results are sure to follow.

It is but fair to state that one trial of this device has been made upon an engine. The reports upon the subject, while tending to show possibly a slight effect, did not show an effect so appreciable large as to warrant the statement that it had been successful. The engineer said that it was a great sand box. To my mind, however (being acquainted with the circumstances and the amount of electric power used on that occasion), I do not consider the test as having been in anyway fair to the device. I do not mean unfair on the part of the people who were making it, but I mean unfair in this sense: That I would as soon have expected to extinguish a house on fire, loaded with rags and petroleum, with a pint of water, as to have expected the volume of current employed, to have performed what was attempted. A dynamo built for a thirty-five ton engine, was placed on a sixty-five ton eight wheeler; and, to my mind, it was almost the same as trying, with a few cells of battery, to perform the work that a dynamo is called upon to perform in arc lighting.

I understand that the inventor has recently made arrangements to make a trial on a large scale, which will prove, conclusively, either the usefulness of the device, or its impracticability upon a large scale; and as railroad men, and especially electrical men, we are, of course, more or less interested in anything of an electrical nature, which becomes or is liable to become a part and parcel of railroad equipment. Possibly at our next meeting this matter will have been tried; if so, whether it be successful or not, I hope to be able to present you with all data in connection therewith.

**Cable Railways—Their Defects and Remedies.**

(Continued from page 97).

CITY DUST.

A candid exposition of a wonderfully alert destroyer—that an unusual income in any branch of trade or commerce permits more or less license in regard to the details of "repair accounts" is an axiom not over young, and the manager is safe as long as he is able to concentrate the gaze of the too inquisitive stock-holder upon returns while he lumps the repair account, made small by comparison with the wonderful accretion from Street Railway traffic. Thus it is found impossible to detect the canker worm's ravages after they have passed into the repair account. So wonderfully true are these conditions that all rolling stock feels it and the "aesthetic electric" finds it almost impossible in some cities, and fully so in others, to secure the capitalistic touch without which nothing however meritorious, ever "gets there."

*The Remedy*

is in the practical application of the axiom that cleanliness is next to godliness. Don't build your tracks if you can't pave them, and don't run your trains without sprinklers. This advice costs you nothing, and if you have a part of the wisdom of the son of David neither mud or dust will continue to be a menace to your property or an annoyance to your passengers.

*Crossing of Steam or other Roads.*

Because of the almost continuous passage of the ponderous trains of steam roads over the tracks of their kind or other city rails and the creeping of the out-going rails, crossings as they are, have been endured while regarded by all as a constant menace. The amount of money necessary to build a perfect crossing, is not and has not been expended, while the thump, thump, thump and the bang, bang, bang are to-day as on yesterday, the tell-tale notes of poor mechanism or wilful penuriousness, and this throughout the endless days of steam traffic life with their poverty-stricken examples before them, is it any wonder that cable and other street car moterage is allowed to jump from point to point on the surface while a frail wrought iron sub-structure trembles on a native cement foundation wall? Of course the alignments of the street car tracks soon have all the sinuosities of the rainbow.

*The Remedy*

is to be found first in a solid dimension stone sub structure laid with the best Portland cement and topped with 30" I beams mechanically interlocked in every part, the bottoms interlocked that they may have adjusting rods passing through



a massive chilled iron bulk head, made accessible by a manhole between the rails of the steam road where, at will, the crossing can be brought accurately to line.

After an excavation of 4x16x16 the crossing walls are laid, generally built of limestone, with lime or natural cement mortar, both utterly useless for the expectant service, because those materials have not the strength to withstand shocks from the wheeled traffic of the streets, much less the ponderous jar of railway trains. In the meantime a wrought iron crossing has been constructed in the company's shops, which in the novice's eye is a perfect network, with the best results obtainable from such material; but stern experience has taught that us all of these combined parts are intrinsically frail, and not when combined with worthless rail crossings (stand-ard though their work be), can the crossing be expected to last "one summer."

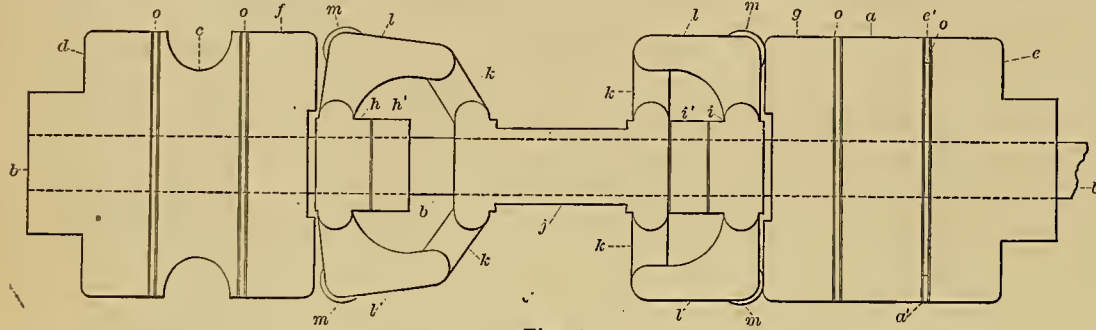

Fig. 1.

How we would build them: After excavations 5x16x16, we would put in a concrete foundation 12x16x16 feet, made of the best Portland cement and Silicate limestone in the order of 1, 2, 3, 4, or one in 9. Upon this we would place a combined boiler iron box or series of frames filled with concrete made in a "2 to 6" order, each arm of the combine underlying each rail with a heavy inch plate capping or top, to which all parts of the superstructure should be immovably fastened by nut-locked bolts. The modern crossing, to be eminently a crossing, should have two or four divisions of the rails forged as one. To illustrate, the center of the center should be one piece of forging, that all squares or rectangles should have endless rail sides for service on the steam or cable lines.

Lastly, an adjustable brace made from 12 inch beams should extend with (under) the steam road rails a convenient distance, perhaps 10 ft. for readjusting the line of the cable track, which is pushed from its place by the creeping of the rails in or at stated intervals of time. The trap or manhole to reach this adjustment need be only a timber box and cover, as it would not be exposed to traffic of any kind.

Referring to the cost of this crossing, we would admit that the material we would use would be 50 per cent. greater in first cost, but the cost of all iron work is legitimate, and for the purpose would not be excessive, but it is the item of la-

ticity should be provided for; opposite effects must be sought for.

(To be Continued.)

**Friction Clutch Device for Constant Speed Motors. \***

The device shown in the accompanying diagram is designed to be used in connection with a constant speed motor for the operation of electric cars, entirely obviating the necessity for using resistance coils. It is a well known fact that the greatest strain thrown on an electric railway motor is when the inertia of the car is being overcome. It is also known that the electric motor, like the steam motor, gives its greatest efficiency at a certain speed, the efficiency being considerably decreased by any variation in the number of revolutions, either greater or less than this. To utilize this feature of the motor is one object expected to be gained

by the use of this device, the details of which are so arranged that, while the motor is revolving at the critical speed, the car may be started and run at the varying speeds demanded by local conditions, or brought to a stand, each and all these requirements being controlled by the motor, the motor running continuously at its critical speed meanwhile. The details of the device may be described as consisting of two

in the diagram, Fig. 1. In front of the faced surface of the flange is a metal collar, *a*, of the same diameter as the flange, but loosely adjusted on the shaft and having perfect freedom of movement. Facing this collar is another flange, *g*, similar to the first, with the exception that it is loosely maintained in its position longitudinally on the shaft, but kept from turning, being held in position by a spline or feather. Between the loose collar and the flanges on each side are interposed several discs of vulcanite vulcanized fibre, *o, o*, or other suitable substance, for the purpose of forming adjustable friction surfaces through which the power of the motor may be communicated to the other portion of the train of gearing. Pressure is brought to bear between these surfaces and the flanges and ring, and the surfaces of the several washers interposed, by a toggle arrangement, consisting of pieces *l, l*, attached to the hub *i*, which has free movement around the shaft but is prevented from being moved longitudinally by the nut *i, i*. These pieces, of which there are three or four, as may be required, are forced against the flange *g*, by a movement of the sleeve *j*, which, communicated through the links *k, k*, operate to produce a strong pressure between the several elements of the clutch, sufficient to make the operation practically the same as though the several elements were one solid piece. It is evident that, by means of the numerous surfaces comprising the friction clutch that the pressure may be varied to any extent required, enabling the car to be moved at any desired speed, the motor still running at its usual speed. The material of which the washers is composed has proved to be so durable that renewals will be required only at long intervals. Another clutch similar in its construction for operating the brakes, is located on the same shaft, and may, if desirable, be operated by the same sleeve when moved in a direction opposite to that required for operating the car. The grooved collar, *c*, serves as a reel or drum on which the brake chain is wound up



THE CARETTES IN CHICAGO. (SEE OPPOSITE PAGE.)

pairs of friction surfaces for operating the car. On the shaft carrying the device, which may be an extension of the armature shaft or an intermediary shaft, or the car axle itself, is a metal

by the revolution of the motor shaft. The friction washers are held in place by bands encircling the loose collar and attached to its circumference by tap screws. This band nut, shown in the diagram, can at any time be easily removed by the use of a screw driver, and new friction rings, which may be cut to allow of their being slipped over the shaft, inserted, this being the only labor required in their renewal, which consumes but a few moments time. Fig. 2 shows a view of the device as attached beneath the car, the dotted lines showing the outlines of car and motor, together with the gears, shaft, etc., also showing the method by which the device is operated from either end of the car. The T shaped piece *z*, the forked end of which *x* engages with and controls the action of the sleeve *j* (Fig. 1), through which perfect operation of the car and brakes is secured.

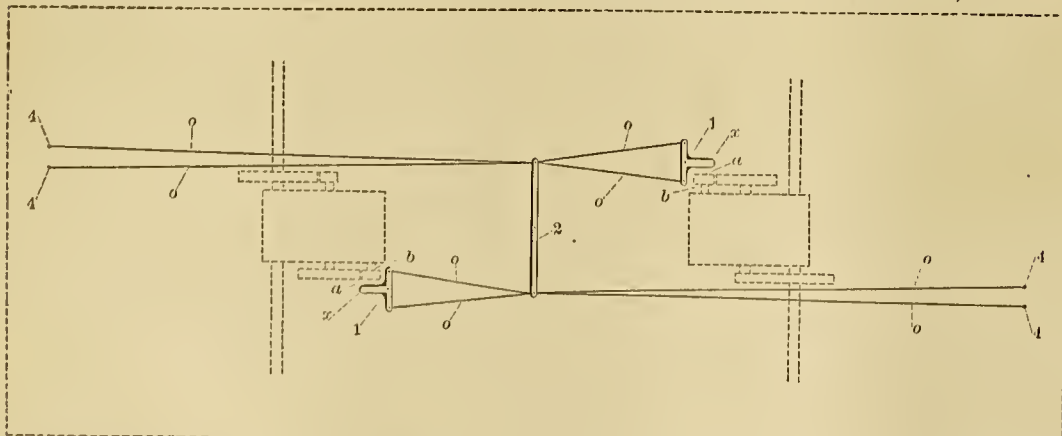

Fig. 2.

bor of putting it in, to say nothing of repairs, which would not exceed 10 per cent. of the cost of the present method. Not a particle of elas-

flange secured to the shaft by set screws, keys, or in any suitable manner, as shown at the right

\* W. B. Clark, 131 Dearborn Ave., Chicago.

Under a new arrangement with the Northern Pacific R. R., passengers can now leave Chicago, daily, at 5.30 p. m. via the Chicago, Milwaukee & St. Paul Ry. for Portland, Ore., via Helena and Tacoma, and arrive at Portland on the p. m. of the third day. Through sleeping car service is now established on this route between Chicago and Portland, Ore.



**Electric Railway Specialties.**

Fig. 1, represents a rawhide armature pinion recently placed upon the market,\* and Fig. 2, a rawhide intermediate pinion.

These pinions are protected in a peculiar manner, prevents their spreading or coming apart. They are so durable that they are considered very economical, perfectly noiseless.



Fig 1.

are protected in a which effectually spreading or come are so strong and are considered very sides being perfectly noiseless.

The Atkinson Overhead Switch is shown in Fig. 3, and it is now considered a necessary part of every Electric road irrespective of the system used. It is the only reliable device by which turnouts can be taken with absolute certainty at ordinary running speeds without conductor or driver having to manipulate the trolley. It is positive in its action, independent of which track the car may take. It is made for either right or left hand turnouts.

Figures 4, 5 and 6 illustrate a complete latticed iron pole, which has proved highly satisfactory on a number of Electric roads. When set at the proper rake, the lacing becomes firmly set when the span wire is tightened and the poles will then stand a direct strain of 3,000 pounds, before permanent deflection. They are very neat in appearance and low in price. The Milwaukee Electric Railway Co., have over 500 in use, and writes: "We believe them to be the strongest and best pole ever made for this purpose. They are strong and ornamental in appearance, and hold the trolley wire up in the very best of shape." The poles are finished when desired, with ratchet and pole top for holding feed wires, etc.

Fig. 7 shows an arch for draw bridge, designed especially for Electric railway purposes.



Fig. 4.

**Large Electric Traveling Crane.**

The Equitable Electric Railway Construction Company, of Philadelphia, Pa., is installing for the Southwark Foundry and Machine Works, (builders of Porter-Allen engines), Fifth and Washington

Ave., Philadelphia, Pa., which is supposed to be up to the present time, the largest electric traveling crane plant ever built. There are two Sellers traveling cranes of 50 tons capacity, each running side by side in the foundry, which is about 400 feet long. The cranes run backward and forward over this entire distance lifting heavy castings out of the sand. Each crane is being equipped with one thirty-five horse power Sprague Standard Motor, and the two are supplied from a 50,000 watt Edison compound generator situated at one end of this building driven by a Porter-Allen high speed engine. The current is conveyed to the motors through a Wheeler double trolley, running on a silicon bronze overhead line.



Fig 7.

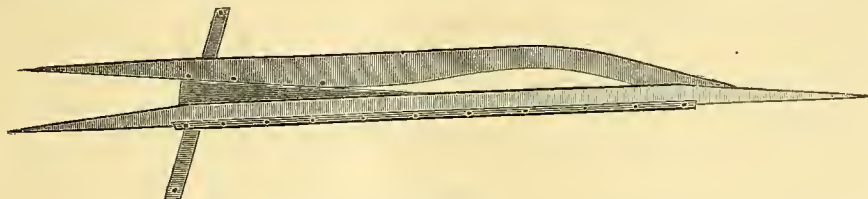

Fig. 3.

**Notice.**

THE AMERICAN STEEL CAR WHEEL CO., OF BOSTON, Mr. A. W. Field, late with the Thomson-Houston Electric company, railway department, and formerly general agent for Frank H. Andrews Co., has connected himself with this company, and will give his personal attention to the sale of wheels for street railway service. W. W. Whitcomb, Sec.

\* Electric Merchandise Co., Chicago.

**Power Station of the Wilmington City (Del.) Railway Company.**

This new station is of the most substantial character, built of brick and slate roof 43x75 feet square, with boiler house adjoining 40x40. The steam house consists of three 150 horse power Westinghouse compound engines for driving the power dynamo, and one 50 horse power Westinghouse compound engine driving a separate dynamo for lighting. Steam is furnished from tubular boilers of 500 horse power capacity.



Fig. 2.

There are six 50,000 Watt Edison generators furnishing power to the road, and one 250 light dynamo running several small stationary motors and lighting the company's offices, which adjoin the power plant. The switch board is of yellow pine and a very handsome affair, 16 feet square with all the instruments placed thereon, and in a very systematic and complete manner. The entire electrical part of this plant is being installed by the Equitable Electric Railway Construction Co., of Philadelphia, under the direction of its chief engineer, Mr. W. A. Stadelman.

**Carettes in Chicago.\***

The accompanying illustration (see opposite page) is a faithful portrayal of the operation of the new carettes in Chicago.

These vehicles are considerably larger than the ordinary omnibus, and have a seating capacity of twenty inside and three on the front seat.

They are nicely upholstered, contain spring seats and backs covered with Wilton carpet. The interior is finished with white natural woods, ash and cherry being used for doors, windows, frames, etc. All the trimmings are of bronze. The style and finish is similar to that of a street car placed upon an improved running gear consisting of steel axles and springs made from the best oil tempered Swede steel, allowing the body of the

vehicle to hang low, the step to the platform being about twelve inches from the ground. By this peculiar construction it can be seen that there is an avoidance of the jolting and swaying so common and annoying with the omnibus, especially on rough streets.

Among the many uses to which the vehicles can be put is that a street railway company can use them to immense advantage on streets over which they have no track franchise, as well as over streets on which track is in course of construction, besides having them as a valuable auxiliary for the expediting of travel during "rush" hours.

The idea of a consolidation of all the street car building interests of St. Louis, Mo., has by no means, been abandoned—unless we are grossly misinformed, negotiations for the "combine" are still being carried on and it looks as though it was simply a matter of time before the deal goes through.

**National Electric Light Association.**

The semi-annual convention of the National Electric Light Association will meet at the Hotel Stockton at Cape May, N. J., on August 19th.

It has not yet been decided what papers will be read before the association, but, as the electric light and power interests are gradually becoming more closely identified one with the other, it is highly probable that some of them will prove of deep interest to the street railway fraternity.

\* Russell Street Carette Co., Chicago.



Fig. 6.



# The Street Railway Gazette.

S. L. K. MONROE, - - - - - MANAGER  
E. V. CAVELL, - - - - - EDITOR.  
EDWARD J. LAWLESS, - - - - - ASSOCIATE EDITOR  
W. L. S. BAYLEY, - - - - - MECHANICAL EXPERT.

## GENERAL OFFICES:

### CHICAGO:

8 LAKESIDE BUILDING.

AGENCIES } San Francisco, - - - 1222 Bush Street.  
          } Toronto (Canada), - - - 53 Magill Street.  
Cable Address=TRAM. CHICAGO.

Annual Subscription (Including Postage).	Per Copy
United States, Canada.....	\$2.00. .... 25c.
Great Britain, Ireland, Indis, Australia	10s. .... 1s.
Germany.....	9mk. 75 pf. .... 89pf.
France, Belgium, Switzerland.....	2fr. 95c. .... Fr 1.10.
Spain.....	2ips. 95c. .... Ps 1.10.
Austria, Holland.....	6fl. 74c. .... 55c.
Italy.....	12 lire. .... 1½ llra.
Venezuela.....	12 bolivars. .... 1½ bol.
Mexico.....	\$3.00. .... 30c.

Annual Subscriptions in Argentine Republic, 2½ peso; Brazil, milreia; Turkey, 54 piasters.

[Entered at the Chicago post-office as second-class matter.]

\* \*

Matter for publication should reach the Chicago Office not later than the last day of each month. All communications should be addressed, THE STREET RAILWAY GAZETTE, Chicago, Ill.

## Consolidations.

In our news items, attention is drawn to the lease of the Broadway Road of New York City to the Houston, West Street & Pavonia Ferry Railroad Company, and the indications for rapid transit on the Broadway line by means of electrical or cable transit are now more favorable than ever.

Chicago, San Francisco, and Philadelphia all have the cable system in active operation, giving satisfaction to the traveling public, and large dividends to the stock-holders of the operating companies, and it appears to us strange that no such rapid transit (barring that afforded by the elevated railways), has been adopted in a city of the size and importance of New York.

We recollect that at the Washington convention of the American Street Railway Association, Mr. C. B. Holmes stated that his line had carried in the neighborhood of fifty million people during the year, and allowing this to be a fair estimate of the amount of travel in a city of over a million inhabitants, it is but reasonable to presume that the amount of travel in a city of the size of New York would certainly be increased in proportion to this.

In the last number of the GAZETTE, reference was made to the consolidation of several important interests in the electrical field, and we expressed the belief that such a union would rebound to the financial advancement and benefit of both the public and the parties most directly interested. Again the question comes up. "How will the consolidation of these great interests in New York affect the city itself and the traveling public?" Upon the theory that in "union there is strength" we incline to the belief that the consolidation of the various street car-companies in New York will certainly prove beneficial to the public, inasmuch as it is almost bound to obtain concessions which could not be granted under other circumstances.

Undoubtedly, the consolidation and amalgamation of the Broadway & Seventh Avenue, the Houston, West Street & Pavonia and other roads in New York is but the inception and forecast plan for a general union of the many street railway interests there; and we venture to predict that the time is not far distant when the

multifarious intermural systems of surface transportation in that city will be brought together under one management.

## "Bewitching Attractiveness."

In a recent number of the Orange, N. J. Gazette reference is made to "the bewitching attractiveness" of poles for use in transmitting electric power for the propulsion of street cars, and the argument is adduced that the poles which are  $\frac{1}{8}$  of inch in diameter are a source of great danger to all who use the cars.

The article appears to us as though it was written for no other purpose than that of filling space, inasmuch as while an occasional attempt is made to be amusing, it is wholly illogical, and the ground taken cannot but arouse the risible faculties of any experienced electric street railway man. One of the main assertions is that "each open car is provided with a heavy rail which runs along the entire length of the left hand side of the car, and on each closed car a chain is provided on each platform which chains, at a certain point, are hooked across the platform on the left hand side."

Immediately following this is an explanation of the "why and wherefore that such things should be," and the explanation shows that the rail or chain is simply used for the prevention of accidents to passengers.

Referring to the open cars in use on the line the article goes on to say that "such a device is an abominable nuisance to passengers, who even with both ends of the seats open, have always been forced to do more climbing over the knees of fellow passengers than was at all agreeable to either the climber or the "climbee."

From our own experience we do not hesitate to affirm that the very paper that attempts to make the care taken of passengers by a street railway company a butt of ridicule and complaint would be one of the very first to denounce the corporation in the event of an accident happening to any passenger by its neglect to take proper precautions. The article closes with the following. "The erection of cross-arms and the suspension of heavily charged electric wires above the tracks would drive all other traffic off the rails, and leave the railroad company in indisputable possession of so much of the street as is occupied by its tracks." If the writer of the article in question were to visit a few of the 150 or more cities and towns in the United States where electric railways are in constant and successful operation, he would probably wield a pen of a different caliber.

## Cabling Third Avenue.

After a long and well fought fight, the Third Avenue Railway of New York City has secured the right to substitute cable traction in place of horses.

By the recent decision of the Court of Appeals at Albany, the decisions of the lower courts have been reversed; and the company is now in a position to push its cable scheme to completion.

In view of the fact of the numerous successes of well-built cable railways as exemplified in Chicago, San Francisco and other cities, it would naturally look to us as though the many objections urged against the operation of the cable line on Third avenue by New York City officials had been prompted more by ignorance of the subject itself than by any personal objection to rapid transit.

That New York City is away behind the times in rapid transit matters, goes without saying and true it is that its elevated railways are a great

acquisition and convenience to the public; but with this single exception the means of conveying passengers from one point to another on Manhattan Island are, undoubtedly, totally inadequate to the swarming population. It is, therefore, with feelings of the greatest satisfaction that we read the decision of the Court of Appeals, and realize that, at last, the Third Avenue Railway Company has won the fight so pluckily sustained, and the public of New York City will now realize the immense convenience and comfort of rapid inter-mural transit. The decision of the Court of Appeals is virtually a confirmation of the constitutionality of the act of 1889, which provides that any street railway company which has obtained the consent of half the property owners along its route, may apply to the State Railway Commissioners for permission to change its motive power.

The constitutionality of that act was disputed on the grounds that it did not include the consent of the local authorities as a *sine qua non* for a change, but the court decided that such consent is necessary only when the grant of new franchises is sought for.

With the cable of the Broadway and the Third avenue lines and probably some others, an important problem in the experience of strikes, viz.: that of feeding and caring for street-car horses will be solved, and inasmuch as the force of employees will be considerably reduced with the introduction of mechanical traction, the influence of walking delegates of the Knights of Labor and other professional agitators and strike organizers will be reduced proportionately.

The day of the street car horse or mule is about past, the hand writing is on the wall, and we incline to the belief that, in the course of a very few years, animal traction, at least so far as street railways are concerned, will have passed into history, and the click of the horse-shoe be heard no more between the rails.

## "Sense and Logic."

In these days of perpetual howling against corporations in general and street railways in particular, it is very refreshing to notice that at least one daily paper reverses the general rule, and holds both arms open in welcome to a street railway project, and very sensibly indeed the editor of the paper to which we refer (the *News* of Greenville, S. C.,) says: "We ought to be willing to give people who offer to do a vastly important and advantageous work for us without asking us to give a dollar directly, the utmost help and encouragement." And, "It is well to be cautious and to protect the state's interests, but there is no sense in being over-cautious, and too suspicious of traps. Because we do not know people we cannot afford to regard them as robbers. If we are to build a town here we must offer the open hand and ready help to everybody who will help to do it." Later on, the article goes on to state: "Of course the electric railroad people come in here with the hope of making money; that is the kind of people we want, and it is to our interest to welcome them and help them to make money, because of every dollar they make we will get a share. They cannot promote their own interest without promoting ours." In looking over the large number of exchanges that come to this office, it is a rare occurrence for a day to pass unless we run across a long tirade of abuse of street railway companies and other equally important corporations, by the daily papers, and the article which we now quote stands out in bright colors by reason of its logic and its justness.



### No Injunction.

In the suit brought by Samuel Lonergan against the Lafayette Ind., Street Railway Company to perpetually enjoin the company from operating its cars by electricity in front of his place of business, the following important decision has been handed down by Judge Byron W. Langdon of the Circuit Court :

The question presented arises on the demurrer for a want of sufficient facts to the complaint asking for a perpetual injunction against the railway company, prohibiting it from operating its cars by electric power and for damages for injuries suffered in consequence of the past use of that motor. The facts material to be noticed now are that the plaintiff is and was before the construction of the defendant company's railway, the owner of a lot abutting on Main street near its western extremity in Lafayette, together with the iron works and blacksmith shop thereon, where he is and has been operating the same.

Main street runs east and west and is the principal thoroughfare in the city, and its west end connects with a highway which passes over a bridge across the Wabash river and continues to the town of West Lafayette, the other roads thence radiating in different directions to the west part of the county. That at present the bridge is being replaced by a new one and travel is temporarily over Brown street bridge spanning the river some four blocks north of Main street. That all travel and traffic from the west side of the county used Main bridge, and will use it again on its completion, and pass along in front of the plaintiff's place of business as it formerly did, unless prevented by the acts of the defendant company.

That in 1882 the defendant obtained a license from the city of Lafayette to build and operate its railway over the center and along the entire length of Main street by horse or electrical power, and in 1887 the board of commissioners of the county granted the company a permit to construct and operate its railway over the Main street bridge and highway to West Lafayette, and in pursuance of these respective grants, the company constructed its tracks and operated its railroad by horse power. That the use of horse power only tended in a small degree to depreciate the value of the plaintiff's lot or impair the plaintiff's business. That afterward the company erected a plant for the generation of electric power, erected poles, laid and suspended wires, and equipped its cars with dynamos and motors, and by means of these appliances commenced to operate its cars and now is, and ever since has been operating the cars by the same power, and causing them to pass over its track every five or ten minutes during the day and part of the night. That by the use of electrical power the cars are moved more rapidly than formerly and without any visible means of locomotion and they make a loud pulsating noise and humming sound and produce, when in motion, flashes of electric light, and especially in damp weather and in the night, and horses not long accustomed to these noises and lights are frequently frightened and rendered uncontrollable and accidents thereby occur. That by reason of these causes of fright to horses, apprehension of danger in the use of Main street has become widespread and has thereby driven some people and business from that street, and especially has the business of the plaintiff been dismissed, and if the company shall be permitted to continue to operate its cars by the same power, the diminution in the value of the plaintiff's business and lot will be aggravated; that the damage to his business by reason of the use of electric motors has been two hundred dollars a year.

It is alleged that temporarily the company is operating its road to the foot of Main street pending the construction of the new bridge, which will be completed within sixty days, and the company is asserting its intention to lay and operate its road over the bridge when completed, and west of it with electric motor, and that by reason of the construction of the bridge and highway their use by the general public in common with the company would be exceedingly dangerous to persons with horses in consequence of being met or overtaken by the cars and thrown from the embankment of the highway and otherwise injured by reason of fright to horses, and the consequence will be to divert a considerable travel and traffic from the Main street bridge to the Brown street bridge, and thereby impair the value of property and business on Main street.

It is then alleged that neither the common council of the city nor the board of commissioners had any power to authorize the use of Main street, the bridge or highway adjoining for the purpose of operating a railway by electrical power, and the grants made by them are void, wrongful and injurious to the plaintiff's property, rights and business. That the company claims the right and threatens to continue the use of its electric cars on Main street and bridge for twenty-one years, the time mentioned in its license. Prayer, as stated, for perpetual injunction, \$500 damages, and general relief.

It should not be overlooked that the paramount consideration implied above, that the purposes of a street railway in both cases are identical and subservient throughout, without diminution the same public needs or demands and no more, and that the discharge of these functions are the prime moving causes which have elicited the legislative sanction to this mode of conveyance in the streets of cities. There is no charge in this case of any negligence either in the construction or operation of the defendant company's railway, nor is there any averment that there is any actual and special obstruction or physical impediment to the ingress to or egress from the plaintiff's premises arising from the construction of the railway; and so, on none of those grounds can damages or any other relief be predicated. The powers of the legislature and of any subordinate political agency in authorizing the occupancy or use of streets and highways are not unconditional. Cities in Indiana are expressly empowered by ss 12 (ss 415 of R. S. 1881) of the

act entitled "An act to provide for the incorporation of street railroad companies," approved June 4, 1861, to authorize the construction and operations of a street or horse railway in the streets and such a license is a *sine qua non* to the lawful exercise of the right by a company. A street or horse car railway may extend its tracks and operate its road over any highway beyond the city limits after having secured the permission of the proper Board of County Commissioners (SS. 1, Act March 9, 1879, p. 179, and SS. 4155, Acts of 1881). If the permits granted to the defendant company are within the limits of the power of the City and Board, the Company is acting in pursuance of a rightful authority, and the operation of its road is not *per se* a nuisance. The Legislature stands for the entire public and has complete and paramount authority over all public ways whether within or without the boundaries of cities or towns, and may authorize acts upon them that would otherwise be deemed nuisances. In virtue of this authority the occupancy of streets by water, telephone, telegraph and gas companies for their respective purposes are made lawful. These powers of the sovereign authority may be delegated to such subordinate municipal agencies as the legislature shall consider promotive of the public interests, and this whether the fee in the streets or highways is vested in the adjoining abuttor or is lodged in some public body. While the effect of such authorization is to convert an otherwise wrongful transaction into a legitimate one it will only protect the donee of the license so long as the acts done under it are within the scope of the grant and in the reasonable exercise of care. The power of the legislature is limited by constitutional restrictions which inhibit the taking of private property for any purpose without precedent compensation is made therefor. It has been held over and over again that it is constitutionally competent for the legislature to sanction the appropriation or use of a street for an ordinary horse railroad and that such appropriation is not a taking of private property within the meaning of the constitution. On the grounds that such a use falls entirely within the original purpose for which streets are laid out or dedicated, the bases of this assumption or conclusion is found in the inference that such street railway responds to the convenience of the local traveling public and the exigencies demanded by modern business methods, and that all these uses are but an extension in a degree of the primary functions of the streets, and are not a different use and the result is that there is no additional or disparate burden imposed by the laying and operation of an ordinary street railroad on a street. The legal consequences flowing from the conclusion are pregnant with important interest to adjoining abuttors as well as persons more remotely located in respect to any depreciation in value of the property or the consequential impairment of their business. The doctrine summed up is that in such a case there is no violation of any private rights of the adjoining property either in his lot or any business that may be conducted on it, because such a use of the street is not contrary to the constitutional prescription that "no man's property shall be taken by law without just compensation."

However correctly courts have settled the rules governing the relative rights of private individuals and the public, in streets and abutting property, it is insisted that the case at bar is not covered by these principles, because the operation of the defendant company's railroad is effected by an electrical motor which is not within the terms or meaning of the legislative grant of powers to the railway or to any city authorizing it to license. To make good this position of the plaintiff it is claimed that the use of such a motor renders the operation of such a street railway extraordinary and inconsistent with common public use of the street and that if this is so there is competent evidence that additional burden has been imposed on plaintiff's property not within the public easement and the rule noticed above, and arising in the case of the heretofore common way of moving such cars by animal power are inapplicable. So then in the different action of the two motor powers must adhere any legal consideration in this case, that can withdraw an electrically operated road although authorized by law from the effect of the accepted doctrine arising in the case of an ordinary horse rail road. Does then the electric motor show that the use of the street is extraordinary and inconsistent with the public easement. The use of a street has been as public needs have required, subdivided and particular portions of public use have been restricted to certain defined limits in the street, as the sidewalks are devoted to foot passengers, and the intermediate spaces to animals, vehicles and other uses. The greater and more complex the uses become the inconveniences to former uses becomes greater and more limited. It is not, then, every inconvenience, impairment or curtailment of the customary accommodations or enjoyments of the general public or the abuttor that will suffice to constitute a legally appreciable deprivation of a right of either. To determine whether a use of a street is without the original public easement, it is quite plain that the inconvenience complained of must be tantamount to a substantial impairment of the public use. In other words, that the use of the street is destroyed or converted into a new use, subversive of its original purpose. If the general public use and operation of the new motor are substantially consistent, they are homogeneous, and the locomotion of the cars by electricity or animal power is a mere dramatical fact, and imparts no substantial significance, because no new burden is imposed and no private property is taken in contemplation of law. The averments in the complaint relevant to this part of the matter are in fact not about the motor itself, but are rather about its manifestations, or the phenomena that follow from its operation. These manifestations are covered by the following allegations: That by reason of the propulsion of the cars by electric power they are driven much more rapidly than by animal power, and in passing over the street they make a loud, churning and pulsating noise, accompanied by a peculiar humming sound, and with the electric wire under the rail, produce constant flashes of electric light, especially at night and in damp weather, and are without visible means of locomotion. It is then

alleged that these several facts cause fright to horses not long accustomed to these sights and sounds when approaching or are being approached by the cars, and they become uncontrollable and run away, and thereby frequent accidents occur. That the fright to such horses and the dangers incident to it have created apprehensions of danger upon the street, and it has become widespread in the community, and has the effect of driving trade and business from this street. The sum of the averments is that some horses not long accustomed to the movement of the cars by the electric motor become frightened and frequently run away. Does then the fact that some horses not long accustomed to the alleged manifestations show that there is a use of the street that is substantially inconsistent with the general public use of it? It is admitted, by implication at least, that horses will become accustomed to these sights and noises, and are tractable as usual. It comes to this, that some horses at first become so frightened until they are broke or familiarized with these sights and noises. It is plain that this inconvenience is temporary and not permanent, or insuperable, nor does it extend to the general public who are driving horses in the street, but is limited to those only who are using such animals. It is a fact and within the common knowledge of all who have observed the operation of these cars in the presence of horses, that the difficulties in their management are overcome in a comparatively short time, except in a few cases, and the streets are and can be used by the entire public passing over the street, in reasonable safety, and without any substantial impairment of the known legal right of any one. Effects not unlike these complained of are witnessed and have been since streets have been used for the movement of processions, parades, shows, passage of machinery or vehicles creating unusual sounds or noises or strange appearing sights, and it has never been considered that such a use was evidence of any additional burden or recognized as furnishing any legal basis for actionable wrongs where proper care was observed. It has been held that a change of motor can not be deemed a change in the use of the street. I do not think the averments raise the legal conclusion that there is such a substantial and permanent impairment of the use of the street by the general public, that it can be inferred that an additional burden has been imposed; and if the defendant company has been authorized by law to use the motor complained of, the depreciation in the value of the plaintiff's property and business is not recognized by the law.

The plaintiff next maintains that the statute does not grant to the defendant company the right to use the electric motors to propel cars over the land in front of his lot, and that entitles to relief. The statute authorizing the chartering of street railways and prescribing their powers and duties, provides that a corporation may be formed by not less than five subscribers to the stock of any contemplated street or horse railroad company, for the purpose of constructing street or horse railroads upon and through the streets of the cities and towns in this State. (SS 4143 R. S. 1881 SS 1 Act 1861 P 75.) The title of the Act reads in these words: "An act to provide for the incorporation of Street Railroad Companies." The plaintiff insists and correctly, too, I think, that this act should be interpreted in the light of the circumstances and knowledge existing in 1861, when the act was passed in reference to the operation or locomotion of street cars. It is claimed that since street cars were then only propelled by animal power, it is reasonable to assume that the legislature intended to enable companies organized under it to construct and maintain a horse railroad, and to exclude the use of any other motor. The paramount purpose of the legislature in enacting the statute authorizing the use of a new and improved mode of travel in cities, was the public convenience. Especial regulations are imposed in reference to gradient and location, but nothing is directly said about the motor. The motor was not a controlling or noticed matter in the immediate purpose of the act. If the prime object was the accommodation of the local public, by the use of this sort of conveyance, how can it be reasonably asserted that this accommodation of the same public by the same way should be restricted to the use of an instrumentality which is only a subordinate means to the ultimate end in view, the accommodation or convenience of the public. If it is correct to say that public utility and convenience are the underlying considerations for establishing authority for the operation of street cars, it would seem that the propelling power should fall within the same consideration as the principal thing. In other words, that public utility or convenience should operate throughout and when it requires it, that the motor should be modified or superseded when not inconsistent with enjoyment of the public easement in the street by the general public, and in the absence of any declaration of a contrary intent it would seem rational to infer that such was the intent of the legislature. The act was passed at a time when it was a matter of common knowledge that mechanical devices were being daily discovered, and were practically applied in almost every department of public and private economies. The legislature was cognizant that science and skill were occupying wider and deeper fields of thought, and activities and new discoveries were used wherever and whenever time, money, health, and the convenience of the people required them. It would seem in such a case, to be an inversion of the true intent and understanding of the legislature to say that all the useful invented appliances of the future should be excluded from public enjoyment, and that the horse or other animal should alone be utilized to propel street cars. The statutes speak of a street railroad in the enacting clause, and in the body of the acts, as street or horse railroads, and this language is sufficiently broad to cover a street railroad whether the cars are drawn by a horse or propelled by the power of an electric dynamo, and the defendant company is in the legitimate exercise of its charter power in using the same. In the view I have taken of the pending question, it is not necessary to examine other questions submitted. The demurrer to the complaint is sustained."

At the conclusion of the decision Mr. Davidson, on behalf of the plaintiff, gave notice of appeal.



Electric Street Railways in North America.

IN OPERATION OR UNDER CONTRACT JULY 1, 1890.

Main table listing electric street railways in North America, including columns for Operating Co., Location, System, Cars, Miles, and a second set of columns for Location, System, Cars, Miles.

Street Railway Securities.

NEW YORK AND BROOKLYN.

REPORTED BY H. L. GRANT, DEALER, No. 145 BROADWAY, N. Y. CITY.

Table of Street Railway Securities for New York and Brooklyn, listing company names, par value, capital, period, rate, last dividend, and bid/asked prices.



Table with columns: NAME OF COMPANY, Par vl, Capital, Period, Rate, Last Div., Bid, Asked. Lists various street railway companies and their financial details.

Table titled 'CHICAGO' with columns for company names, amounts, and dates. Lists Chicago City Railway, Chicago Passenger Railway, etc.

Associations.

OFFICERS, DATES OF MEETINGS, ETC.

AMERICAN ST. RY. ASSOCIATION.

President, Thomas Lowry, Minneapolis, Minn. First Vice-president, C. Densmore Wyman, New York. Second Vice-president, J. C. Schaffer, Indianapolis, Ind.

EXECUTIVE COMMITTEE.

The President, Vice-Presidents, and Geo. B. Kerper, Cincinnati, O. Geo. W. Kiely, Toronto, Can. R. Semmes, Memphis, Tenn. F. H. Monks, Boston, Mass. Francis M. Eppley, Orange, N. J.

N. Y. ST. RY. ASSOCIATION.

President, John N. Partridge, Brooklyn. Vice Presidents, Daniel B. Hasbrouck, New York. P. B. Brayton, Syracuse. Secretary and Treasurer, William J. Richardson, Brooklyn.

MASS. ST. RY. ASSOCIATION.

President, Chas. H. Odell, Salem. Vice-Presidents, H. M. Whitney, Boston. Amos F. Breed, Lynn. F. O. Stearns, Swansea. Secretary and Treasurer, J. H. Eaton, Lawrence.

THE ST. RY. ASSOCIATION OF THE STATE OF NEW JERSEY.

President, John H. Bonn, Hoboken. Vice-President, S. S. Battin, Newark. Secretary and Treasurer, Charles Y. Bamford, Trenton.

EXECUTIVE COMMITTEE.

John H. Bonn, Hoboken. S. S. Battin, Newark. C. Y. Bamford, Trenton. C. B. Thurston, Jersey City. John Hood, Camden. A. Q. Keasbey, Elizabeth.

OHIO STATE TRAMWAY ASSOCIATION.

President, Wm. B. Hayden, Columbus. Vice-President, John N. Stewart, Ashtabula. Secretary, A. E. Lan, Toledo. Treasurer, J. B. Hanna, Cleveland.

EXECUTIVE COMMITTEE.

Ross Mitchell, Springfield. The annual convention of the Association will be held in Columbus, O., on November 19, 1890.

WESTERN ELECTRIC RAILWAY ASSOCIATION.

President, T. J. Evans, Council Bluffs, Ia. Vice-President, H. E. Teachout, Des Moines, Ia. Secretary, W. L. Allen, Davenport, Ia. Treasurer, W. R. Moore, Moline, Ill.

NATIONAL ELECTRIC LIGHT ASSOCIATION.

President, M. J. Perry, Providence, R. I. 1st. V. President, E. A. Maher, Albany, N. Y. 2nd. V. President, C. L. Edgar, Boston, Mass. Sec. and Treas., A. V. Garratt, New York.

EXECUTIVE COMMITTEE.

Chairman, C. R. Huntley, Buffalo, N. Y. E. R. Weeks, Kansas City, Mo. James English, New Haven, Conn. F. A. Armstrong, Camden, N. J. C. H. Wilmerding, Chicago, Ill. M. J. Francisco, Rutland, Vt. A. F. Mason, Boston, Mass. John A. Sheley, New York. H. K. Thurber, New York. Next convention will meet at Stockton Hotel, Cape May, N. J., on August 19, 1890.

AMERICAN INSTITUTE OF ELECTRICAL ENGINEERS.

President, Elisha Thomson. Presidents—Dr. Louis Duncan, Francis R. Upton, T. Cummerford Martin, Edward Weston, Major O. E. Michaelis and Prof. Edward L. Nichols. Treasurer, George M. Phelps, 150 Broadway, New York. Secretary, Ralph W. Pope, 5 Beekman St., New York. Managers—Dr. Schuyler S. Wheeler, Joseph Wetzler, Francis B. Crocker, John W. Howell, Charles Cuttriss, George B. Prescott, Jr., Thomas D. Lockwood, William Maver, Jr., Dr. F. Benedict Aertzog, Prof. Wm. E. Geyer, H. C. Townsend and Henry Van Hooenburgh. Board of Examiners—W. B. Vensize (chairman), F. W. Jones, C. O. Majloux, E. H. Birdrall and Edward P. Thompson.

LEGAL DECISIONS.

COURTS OF LAST APPEAL.

INJURY OF FIREMAN WHILE ON DUTY.— Magee v. West End Street Railway Co.; Supreme Judicial Court of Massachusetts, Feb. 27, 1890; 23 N. E. Rep. 1102.

Action against street railway company for damages. The plaintiff, a fireman, was injured while riding to a fire on a ladder truck, by a collision with a horse car of the defendant company. On first starting out plaintiff was standing on the running board, ringing a gong; but, as he had not fully equipped himself before starting, he shortly proceeded to complete his equipment by buckling around his body a "dog-man's belt."

RIOTOUS AND UNLAWFUL INTERFERENCE OF CITY OFFICIALS.—Appeal of Easton, S. E. & W. E. P. Railway Co.; Supreme Court of Pennsylvania, March 24, 1890. 19 At. Rep. 486.

The railway company relaid its tracks with T rails, and thereafter the city council passed an ordinance requiring all plans for changes, or laying of tracks to be submitted for its approval. A portion of the relaid track was thereafter torn up by a street contractor and upon the refusal of the city to relay the track it was laid again with T rails by the company, though a municipal order had been served upon them forbidding them to so construct it again.

these rails laid down months before, and making no objection thereto, suddenly decide that it was an unlawful structure, and proceed to abate it with a strong hand? Conceding that the city had rights in this matter which the company were bound to respect, it is equally clear that the company had rights which the city officials were bound to respect. It is true a municipality may, with a strong hand, abate a public or a common nuisance which endangers either the health or the safety of its citizens. This much was decided in Klingler v. Bickel, 117 Pa. St. 326, 11 At. Rep. 555. But no one contends that this road was a nuisance of this character, if a nuisance at all.



matter of controversy. They have not filed a cross-bill, nor have they applied to this court or any other court to adjust the differences between the city and the appellant company. They have no prayer for relief. On the contrary they have assumed to decide the delicate questions involved for themselves, and to enforce their decision by the strong hand. This cannot be permitted. We are of the opinion that their acts were unlawful, and that the plaintiff is entitled to the relief prayed for. The decree is reversed and the bill reinstated, and it is ordered that the record be remitted to the court below with directions to issue an injunction as prayed for; the costs to be paid by the appellees.

**ELECTRICITY AS MOTIVE POWER.**—*Williams v. City Electric Street Railway Co.*; Circuit Court of the United States, Eastern District of Kansas, March 26, 1890. 41 Fed. Rep. 556.

This was an action in which it was sought to restrain the equipment of a street railway with electricity on the ground that such franchise should be granted under the conditions relating to steam railroads and not those relating to street railroads. The Court say: "The difference between street railways and railroads for general traffic is well understood. The difference consists in their use, and not in their motive power. A railroad, the rails of which are laid to conform to the grade and surface of the street, and which is otherwise constructed so that the public is not excluded from the use of any part of the street as a public highway; which runs at a moderate rate of speed, compared to the speed of traffic railroads; which carries no freight, but only passengers from one part of a thickly populated district to another, in a town or city and its suburbs, and for that purpose runs its cars at short intervals, stopping at street crossings to receive and discharge its passengers, is a street railroad, whether the cars are propelled by animal or mechanical power. The propelling power of such a road may be animal, steam, electricity, cable, fireless engines, or compressed air; all of which motors have been, and are now, in use for the purpose of propelling street cars. (Encyclop. Britannica, 9th Ed. tit. "Tramway.") Doubtless other methods of propelling the cars of street railways will be discovered and applied. The legislature having empowered the city to authorize the construction of street railroads, without qualification or restriction as to the motive power to be used on such roads, the city has the undoubted right to authorize animal or mechanical power to be used as motors on such roads. Sections 5468-5471, Mansf. Dig., relate to railroads for general traffic and not to street railroads, whether propelled by animal or mechanical power. It would be a useless consumption to cite authorities to show that it would be competent for the city, under its character, to authorize the construction and operation on the streets of the city, of a street railroad propelled by animal power, without providing for compensation to the abutting lot-owners; but the learned counsel for the plaintiff insists that the rule is different where the propelling power is steam. The distinction attempted to be drawn between animal and mechanical power, as applied to street railroads, is not sound. The motor is not the criterion. It is the use of the street, and not the mode of that use. A street railroad propelled by animal power might be so constructed and operated as to be a public nuisance, and render its owners liable to those injured by its improper construction and operation. The same is true of a street railroad operated by mechanical power. It may be so constructed and operated as to be a public nuisance, but the use of steam on such a railroad, when authorized by law, does not *per se* make it a nuisance, or entitle the owners of abutting property to compensation, though the fee of the street is vested in them. It is common knowledge that steam motors, for operating street railroads, are now constructed to emit so little gas, steam, or smoke, and make so little noise, that they do not constitute any reasonable ground of complaint to passengers or the public. They can be stopped and started as quickly and as safely as horse cars, and in some respects can be operated with greater accuracy and precision. Such motors are in use in cities and their suburbs in

this country and in England. (Encyclop. Britannica, 9th Ed.) The operation of a street railroad by such steam motors, when authorized by law, on a public street, is not an additional servitude or burden on the land already dedicated or condemned to the use of a public street, and is therefore not a taking of private property, but is a modern and improved use, only, of the street, as a public way, and affords to the abutting property owner, though he may own the fee of the street, no legal ground of complaint. (*Briggs v. Railroad Co.*, 79 Me. 363, 10 At 1, Rep. 47; *Newell v. Railway Co.*, 27 N. W. Rep. 839; *People v. Kerr*, 27 N. Y. 204.) But a steam motor may be of such a construction, or operated in such a way as to create a public nuisance to the injury of the owners of abutting property; and where that is the case, the legislative authority to construct the road will be no justification of the nuisance. If, however, the defendant's road is operated by the use of the improved steam motors generally used on street railroads, and the emission of smoke, gas and steam, and the noise produced by blast, are no greater than necessarily attend the operation of such motors supplied with the improved appliances and contrivances in common use, then the plaintiff has no ground of complaint at law or in equity. Whether the defendant's road is or not so operated, need not be decided, because, in any event, the plaintiff, on the facts of the case, is not entitled to an injunction, but her remedy, if she has any, is at law. (*Osborne v. Railroad Co.*, 35 Fed. Rep. 84, 37 Fed. Rep. 830.) The injunction is refused and the bill dismissed without prejudice to the plaintiff's right to sue at law.

**LIABILITY OF COMPANY FOR LAWFUL AND PROPER OPERATION OF ROADS.** *People's Passenger Railway company v. Hazel*; Supreme Court of Pennsylvania, February 3, 1890. 18 At. Rep., 1116.

This is an action for the negligent killing of plaintiff's horse. From a judgment for plaintiff defendant appeals. Facts in opinion. The court say: "The horse, hitched to a carriage, and in charge of the driver, was standing quietly on the side of the street and without the least preliminary movement, he reared upon his hind feet and fell over dead; it was a very busy and thronged part of the city. The ordinary noise of the street occurred, but of no unusual character. The horse belonged to and was constantly used by the plaintiff, who was a physician, and had been so used for two years prior to the accident. When the horse fell he was instantly dead. What was the cause of his death? Nobody testifies on that subject, and the probability is nobody knows. But if it be conceded that the horse died from a fall, what had the defendant to do with the fall? A theory is also offered on the subject and the jury is allowed to act upon the basis of this theory in making that their verdict. It is this: That the horse became frightened by one of the defendant's street cars, and the car caused the horse to become frightened, and the fright caused him to rear upon his hind feet, and the rearing caused him to fall, and the fall caused his death. Every step in this process is the merest and baldest theory without any actual substantial fact to support it. The last step mentioned is perhaps the weakest and most unsubstantial of all. But suppose the horse did become frightened at the street car, it is certainly not true in law that the street car company is responsible for horses becoming frightened at the movements of their cars; they have just as much right to run their cars on the streets of the city as other citizens have to drive their carriages and horses. We discussed this question sufficiently in *Piolet v. Simmers*, 105 Pa. St., 95, and *Railway Company v. Taylor*, 104 Pa. St., 306, to render any further discussion unnecessary. All the witnesses testified that there was nothing unusual in the movements of the car. The case is simply absolutely destitute of testimony establishing the relation of cause and effect between the action of the defendant and the death of the horse in a sense in which the defendant can be held responsible." Judgment reversed.

**FRIGHTENING HORSES BY PROPER SIGNALS.**—*Stenier v. Philadelphia Traction Co.*; Supreme

Court of Pennsylvania, April 7, 1890. 19 At. Rep. 490.

The plaintiff appeals from a judgment of nonsuit on a complaint under which it was sought to recover from the company on the ground that it was negligent in having its alarm bell unnecessarily rung, by which the team of plaintiff was frightened and ran away. The court say: "The plaintiff has no cause to complain that he was nonsuited by the court below. He had no case. His claim was a mere attempt to speculate upon the credulity or the prejudices of a jury, and the learned judge below properly held there was nothing to submit to them. The car did not touch the plaintiff or his team. The accident was wholly due to the fright of his horses. It was urged, however, that the gripman stopped his car where he should not have done so, and rang his bell needlessly. But he stopped at or near a crossing where he had a right to stop. We do not know why he stopped nor are we bound to inquire. It may be he saw the horses were restive, and feared coming into a collision with them, so far as ringing the bell was concerned, the case closely resembled *Traction Co. v. Bernheimer*, 125 Pa. St. 615, 17 At 1. Rep. 477, where we said: "It was not negligence to ring the bell as the car approached Fourth street. It would have been negligent not to have done so." The bell at a traction car is not only rung at all street crossings but frequently at other places, to warn persons of its approach. Nor does such ringing necessarily tend to frighten horses. If it did there would be accidents daily. We have said emphatically that it would be negligence not to ring at a crossing, and the plaintiff would probably have been swift to invoke the benefit of such rule had his injury resulted from an omission to do so. If we now say, or permit a jury to say, that it is negligence to ring at a crossing, what rule would the company or its gripman have to guide them in such cases? We may supplement these remarks by saying that, in view of the crowded condition of the streets of the city of Philadelphia, the number of women and children and of aged and infirm persons who are constantly crossing the tracks of the traction company, not only at street intersections, but elsewhere, we would be loth to sanction a principle which would make a gripman hesitate to ring every time his hand touched the bell rope. Judgment affirmed.

**KNOWLEDGE OF SERVANT AS DEFENSE FOR INJURY.**—*Donahue v. Enterprise Railway Co.*; Supreme Court of South Carolina, March 18, 1890. 11 S. E. Rep. 95.

This was an action to recover damages for injuries resulting from plaintiff's intestate having been kicked by a horse which he was employed by defendant to drive. The complaint was demurred to because plaintiff did not allege that deceased did not know the horse was vicious and unruly, and from an order overruling the demurrer the defendant appealed. The Court say: "It cannot be necessary for the servant either to allege or prove that he did not know, or did not have the means of knowing, that the agency which he was called upon to use was unfit or unsafe, as it is the duty of the master, and not of the servant, to look after that matter, and hence his want of knowledge does not constitute any part of his cause of action. It is true that where it is shown, by way of defense, that the servant either knew, or ought to have known, the dangerous character of the agency which he was called upon to use, and still voluntarily continued to use it, his action may be defeated; but that it is upon the ground that he has, by his own negligence, contributed to the injury of which he complains. And it is well settled in this state, at least, that contributory negligence is an affirmative defense. *Carter v. Railroad Co.*, 19 S. C. 20; *Crouch v. Railway Co.*, 21 S. C. 495; *Darwin v. Railroad Co.*, 23 S. C. 531. It follows necessarily that it is not necessary to negative such negligence in the complaint. While it is true that the precise question which we are now called upon to consider has never, so far as we are informed, been authoritatively decided in this state, yet we think that the conclusion which we have reached follows necessarily from what has been decided. To adopt the language of Mr.



Justice McGowan in Crouch's case, supra, we think that, in cases of this kind, "the conduct of the plaintiff is not a necessary element in his cause of action and to be alleged and proved by the defendant, \* \* \* \* We think it follows, from the *onus* of proof being on the defendant, that it is not necessary for the plaintiff to make the allegation of due care in his complaint, and thus anticipate the defense." The judgment of this court is that the judgment of the circuit court be affirmed.

DAMAGES FOR INJURY OF MARRIED WOMAN.—*Urnsby v. Dry Dock E. B. & B. Ry. Co.*; Court of Appeals of New York. 23 N. E. Rep. 451.

Appeal from judgment for plaintiff. The court says:—"The recovery had was for damages sustained by the plaintiff, a married woman, by reason of personal injuries received while a passenger on defendant's road. Presumptively, damages for negligently diminishing the earning capacity of a married woman belong to her husband, and when she seeks to recover such damages the complaint must contain an allegation that for some reason she is entitled to the fruits of her own labor; or, if she seeks to recover damages for an injury to her business, she must allege that she was engaged in business on her own account and by reason of the injury was injured therein as specifically set forth. No such allegations are contained in the complaint in this action. Nevertheless the plaintiff was permitted to prove, against the objection of the defendant, that the evidence was irrelevant and immaterial, and called for special damages not alleged in the complaint; that she was engaged in the dress making business; sold fancy goods and dry goods; was accustomed to make from \$16 to \$20 per week; and that because of her injuries was prevented from working for two months. This was error. *Gumb v. Railroad Co.*, 114 N. Y. 411, 21 N. E. Rep. 993; *Saffer v. Railroad Co.*, 5 N. Y. Supp. 700. The respondent, in supporting the ruling, cited *Hartel v. Holland*, 19 Wkly. Dig. 312, and *Ehrgott v. Mayor*, etc., 96 N. Y. 275. But the question here presented, involving the right to recover damages which the law does not presume to be the immediate and natural consequences of the injury, in the absence of a special averment of such damages, does not appear to have been raised or passed upon in either case. Therefore they do not support the respondent's contention. As the exception taken to the ruling of the court referred to calls for a reversal of the judgment, it is unnecessary to consider the other exceptions taken. Judgment reversed."

CONTRIBUTORY NEGLIGENCE.—*Miller v. St. Paul City Railway company*; Supreme Court of Minnesota, February 7, 1890. 44 Rep., 533.

The tracks of defendant's cable railway are placed so near together that cars going in opposite directions come within two feet of each other. Plaintiff, who sues for personal injuries, alleging negligence of defendant, stood between the tracks for the purpose of taking a car, and was injured by two cars passing each other where he stood. The testimony shows that the gripman operating one of the cars saw plaintiff, and could readily have stopped his car before the accident occurred, but made no effort to slack his speed until within about ten feet of him. The judgment was for plaintiff and appeal by defendant. The court says: "A question is presented whether the important facts do not show that the plaintiff was guilty of contributory negligence. The plaintiff was acquainted with the situation and must have known that the train might be expected on the track going west at any time. He must have known that as the car he was going to take should come to where he was standing, and while it was coming to a stop, and until he could get on it, it would necessarily obstruct any attempt that might be necessary to get out of the way of the car passing on the other track. He must have known that to occupy such a position involved danger to himself. There was nothing to prevent him from seeing the other train. No sudden emergency is shown to have arisen to affect the plaintiff's conduct or to attract his attention; no occasion for hasty or thoughtless

action. That the plaintiff deliberately placed himself in a position which subjected him to the danger of serious injury unless he should guard himself by watchfulness is we think so apparent that a contrary conclusion would be unreasonable under these circumstances. The conclusion that the plaintiff appears to have been guilty of contributory negligence can not, upon the facts as they now appear, be avoided. This is a clearer case in favor of defendant upon this issue than was that of *Reed v. Railway company*, 34 Minn. 557, 27 N. W. Rep., 77." Judgment reversed.

NEGLIGENCE OF A MOTHER IN ALLOWING A CHILD TO GO UPON THE STREET IMPROPERLY ATTENDED IS NO DEFENSE TO AN ACTION BY THE CHILD FOR DAMAGES.—A VERDICT AGAINST A COMPANY WILL BE SUSTAINED WHERE THE EVIDENCE SHOWS LACK OF EXTRAORDINARY CARE ON THE PART OF THE GRIPMAN. *Winters v. Kansas City Cable Railway company*; Supreme Court of Missouri, December 21, 1889. 12 S. W. Rep., 652.

This was an action for personal injuries sustained by plaintiff, a boy three years of age, who was so injured by one of the cable cars of defendant's road that the amputation of one of his legs became necessary. The facts were that one of defendant's gripmen, coming upon a curve, looked ahead to see that the track was clear, and seeing no obstruction went on. Plaintiff, with his ten-year old sister was on a crossing and came upon the track in such a manner that the gripman failed to see him until it was too late to control the car. There was judgment for plaintiff and appeal by defendant. The court says: "If the defendant's liability in this case is limited to want of care on the part of its servants after they saw the boy in a dangerous situation, then the plaintiff failed to make out a *prima facie* case. The evidence is all to the effect that the gripman used all the means at his command to avoid the calamity after he knew the boy was in danger. But the principle of law just stated does not control this case. The defendant is operating dangerous machinery at a rapid speed on and along the public streets of the city, and must know and in law is bound to know that men, women and children have an equal right to the use of the highway, and will be upon it. It is the duty of the defendant's servants to be on the look-out to avoid injuries to persons who may be upon the street. If we say the jury should have been instructed to find for defendant, then we must hold as a matter of law that it was sufficient care on the part of the gripman when approaching the curve, to ring his bell, see that the track before him was clear, and go ahead without thereafter looking to the right or left. This we are not prepared to do. The court, at the request of plaintiff gave this instruction, (3). The court instructs the jury, as a matter of law, that negligence on the part of the little girl who was with the child injured, or near him at the time of said injury, can not affect the question of the right of plaintiff to recover in this case," but refused to give the following instruction asked by the defendant: "(2) If the plaintiff's mother and natural guardian permitted plaintiff to go on or near the tracks of defendant, alone or in charge of a careless or incompetent person, and the carelessness and incompetency of such person contributed directly to plaintiff's injury, then the finding will be for defendant." *Hartfield v. Raper*, 21 Wend., 615, is cited to show that the court erred in its ruling on both of these instructions. The substance of the doctrine there asserted is that when a child of such tender years as not to possess the discretion to avoid danger, is permitted by its parent or guardian to be in the public highway, the negligence of the parent or guardian will defeat a recovery in a suit by the child. This doctrine has been followed in some of the states. This court, however, repudiated the doctrine more than twenty years ago in the case of *Boland v. Railroad Co.*, 36 Mo., 485. The court there gives its adherence to the doctrine asserted in the leading case of *Robinson v. Cone*, 22 Vt., 213. The case at bar is a suit by the child itself, and the negligence of the mother, if any there was,

in allowing it to go upon the public streets unattended by a person of mature years, constitutes no defense whatever in this action. Judgment affirmed.

INJURY OF PASSENGER WHO IS NOT PROVIDED WITH SEAT.—*Lexs v. Steinway & H. P. Ry. Co.*; Court of Appeals of New York, Feb. 25, 1890. 23 N. E. Rep. 889.

Plaintiff in this case was injured while riding upon the front platform of a car of defendant, where he had gone because there was no seat for him in the car. From a judgment for plaintiff the defendant appeals. The court says: "The defendant moved for a nonsuit, on the grounds that the plaintiff had failed to establish that the defendant negligently caused the accident, and that he had not affirmatively shown that he did not negligently contribute to the accident. The motion was denied, and the defendant excepted. The court ruled that there was no evidence that the road or car was defective, or that the defendant negligently employed an unskillful or incompetent conductor or driver; but instructed the jury that if they found the defendant negligently permitted the car to be overloaded, and that overloading caused the accident, the plaintiff could recover, unless the accident was caused in part by some negligent act of his which was a contributing cause of the accident. The exposure of a passenger to a danger which the exercise of reasonable foresight would have anticipated and due care avoided, is negligence on the part of the carrier. It clearly appears that the defendant undertook to carry more passengers than could sit and stand within the car, and that both platforms and their steps were filled to their utmost capacity. The action of persons so crowded together, and the great force that they exercise, sometimes unconsciously, on each other, is understood by carriers of passengers and their employes; and the court would not have been justified in nonsuiting the plaintiff, and holding, as a matter of law, that the exercise of reasonable foresight would not have led the defendant to anticipate that overcrowding this car and its platforms might render accidents like the one which befel the plaintiff probable. Whether the defendant was negligent in carrying so many passengers was a question of fact for the jury. The court properly refused to instruct the jury that the plaintiff was negligent in surrendering his seat to his wife, and seeking a place on the platform. It cannot be held, as a matter of law, that a passenger surrendering his seat to one less able to stand than himself contributes to an injury caused by the carrier's negligence, but which would not have been received had he remained in his seat. The defendant made no attempt to show that persons entered on the car against the wish or protest of the conductor or driver, or that the rules of the defendant required that the car should not be overloaded, or that the conductor and driver made any attempt to prevent the car from being unduly crowded. Whether the defendant negligently caused the injury to the plaintiff, and whether he negligently contributed to his own injury, were, under the evidence, questions of fact for the jury; and, finding no error in the submission of the case, the judgment should be affirmed with costs."

INFRINGEMENT OF CABLE PATENT.—*American Cable Railway Company v. Chicago City Railway Company*; Circuit Court of the United States, Northern District of Illinois, February 10, 1890, 41 Fed. Rep. 522.

"This is a bill in equity praying an injunction and accounting for profits and damages by reason of the alleged infringement of patent No. 131,913, granted October 1, 1872, to Abel Thompson, for 'an improvement in street railways.' Defendants demur to the bill on the ground that it does not show a case for the jurisdiction of a court of equity, and because it appears upon the face of the patent, which is made a part of the bill, that it is void for want of patentable novelty. The bill was filed on the 16th day of September, 1889, subpoena served on the 17th day of the same month, returnable on the first Monday in October then next, which was on the 7th day of the last named month. Equity rule 17



requires the defendant to appear on the rule-day to which the subpoena is made returnable, when the service is made 20 days before that day. By excluding the day of service, and including the return-day, which is the practice of this court in computing time for this purpose, this process was served in time to require the appearance of the defendant on the 7th day of October. The patent was granted on the 1st day of October, 1872, and expired on the 1st day of October, 1889; so that the patent had expired when the defendants were required to appear, and when, if they had been duly served, and had not appeared, they could have been defaulted. In *Root v. Railway Co.*, 105 U.S. 189, it was held that equity only takes jurisdiction in suits for the infringement of a patent where the bill shows that part of the complainant's remedy is the right to an injunction, or some special equitable relief, the foundation for which is laid in the bill. And in *Clark v. Wooster*, 119, U.S. 322, 7 Sup. Ct. 217, the court clearly intimates that if no injunction could have been obtained the bill ought to be dismissed. In the case now in hand the patent had fourteen days of life when the bill was filed, and no application for an injunction *pendente lite* was made; and the patent had expired before the return day of the process, and before the complainant would have been entitled to a default, even if the defendants had not appeared and defended. As there is no special case made by the bill showing that an injunction was part of the remedy to which the complainant would be entitled by reason of special facts alleged, it follows that no injunction would have been awarded by the court if the complainant had obtained a decree *pro confesso*. The case therefore comes clearly within the rule in *Root v. Railway Co.*, and the bill must be dismissed for want of jurisdiction. My conclusion upon the first point renders it unnecessary to consider the question as to the novelty of the device covered by the patent."

**DAMAGES TO ABUTTING PROPERTY BY ELEVATED RAILROAD.**—*Newman v. Metropolitan El. Ry. Co.*; Court of Appeals of New York, March 4, 1890; 23 N. E. R. p. 901.

Action for damages to property by construction of elevated road. From a judgment for plaintiff, defendant appeals. The court say: "The principle upon which compensation is to be made to the owner of lands taken by proceedings under the general railroad law has been frequently considered by the courts of this state; and the rule is now established that such owner is to receive, *first*, the full value of the land taken; and *second*, where a part only of land is taken, a fair and adequate compensation for all injury to the residue sustained, or to be sustained, by the construction and operation of the railroad. *Railroad Co. v. Lee*, 13 Barb. 169; In re *Utica R. Co.*, 56 Barb. 456; In re *Prospect Park & C. I. R. Co.*, 13, Hun, 345; In re *New York C. & H. R. R. Co.*, 15 Hun, 63; In re *New York, L. & W. R. Co.*, 29 Hun, 1; Id. 2 N. Y. Supp. 478; *Henderson v. Railroad Co.*, 78 N. Y. 423. The first element in the award represents the compensation for the land which the railroad takes, and to which it acquires title. The second element represents damages which are the result or consequences of the construction of the road upon the property not taken, and which the owner still retains. Such damages are wholly consequential, and to ascertain them, necessarily involves an inquiry into the effect of the road upon the property, and a consideration of all the advantages and disadvantages resulting, and to result therefrom, the rule is well stated in *Lewis, Em. Dom. Sec. 471*, as follows: 'Where part of a tract is taken, just compensation would therefore consist of the value of the part taken, and damages to the remainder less any special benefits to such remainder by reason of the taking and use of the part for the purpose proposed.' In this rule, thus settled in this state, and which controls all awards for taking of land under the general railroad act, is to be found the true application of the statutory provision which forbids deductions and allowances to be made by commissioners for any real or supposed benefits which the parties interested may derive from the construction of the railroad. Whatever land is taken must be

paid for by the railroad company at its full market value; and from such value no deduction can be made, although the remainder of the land owner's property may be largely enhanced in value as a result of the operation of the railroad. But, in considering the question of damages to the remainder of the land not taken, the commissioner must consider the effect of the road upon the whole of that remainder, its advantages and disadvantages, benefits, and injuries; and if the result is beneficial, there is no damage, and nothing can be awarded. The rule established under the general law must govern and control awards made under the rapid transit act. The last named act confers upon corporations formed thereunder the power to acquire property for railroad purposes; and the statutory proceedings prescribed are substantially the same as those under the general railroad act; and no reason is apparent why the same rule should not apply to proceedings under both acts." Judgment reversed.

**LEGAL EFFECT OF TENDER AND PAYMENT INTO COURT.**—*Taylor v. Brooklyn Elevated Ry. Co.*; Court of Appeals of New York, March 18, 1890. 23 N. E. Rep. 1106.

In this action the defendant tendered judgment for \$200, and, not being accepted by plaintiff, the money was paid into court. Thereafter judgment was rendered for defendant, plaintiff being given no recovery. Thereupon defendant demanded a return of the \$200, and from an order directing its payment to plaintiff, appealed. The Court say: "We think the order was right. The moneys belonged to the plaintiff from the moment of their deposit, by force of their payment into court under this order. It was held in *Slack v. Brown*, 13 Wend. 390, and in *Dakin v. Dunning*, 7 Hill, 30, that when the money was brought into court it belonged to the plaintiff in any event. In the more recent cases of *Becker v. Boon*, 61 N. Y. 317, and *Wilson v. Doran*, 110 N. Y. 101, 17 N. E. Rep. 688, Judge Earl, delivering the opinion of the former, and Judge Andrews in the latter case, it was assumed by them that moneys paid into court by a defendant, under a tender, became the property of the plaintiff in all events, and that his title to them cannot be disputed. The plaintiff runs the risk, in proceeding, after a tender or deposit, of paying defendant's costs if the recovery falls short of the amount tendered; while the defendant, in such a case, runs the risk of losing that amount of money in the event of his success upon the ensuing trial. When the moneys are brought into court they become the plaintiff's; and it is immaterial as to the question of their ownership, what the result of the trial may be. This result is a just one. The defendant had two courses available to it, under the code, which regulates the procedure in civil actions. It elected to take that one which involved the tender or payment of money to the plaintiff, and paid the money into court upon the refusal of its tender, under an admission of liability *pro tanto*, and to make sure that the plaintiff could not say that she had not been paid so much, in any event. The order appealed from is affirmed, with costs."

**LIABILITY OF STREET CAR COMPANY FOR NEGLIGENCE OF DRIVER.**—In an action for personal injury to plaintiff while riding in one of defendant's horse cars, it appeared that, as the car was passing over a drawbridge, a key and pole weighing about 300 pounds fell, one end of the pole projecting about three feet into the car, and causing the injury. The pole and key, when not used for operating the drawbridge, were hung upon two railroad spikes driven slantingly into the trestle wood near the track. The evidence was conflicting, but tended to show that the undue rate of speed of the car caused the bridge to oscillate, and dislodge the key and pole. The driver testified that he "was always afraid of an accident, was always afraid it would fall," and that he knew if he "went over on a trot it would shake the bridge," and "the faster you go the more it will shake the bridge." A case was made out calling for submission to the jury of the question of the negligence of defendant's driver, and a judgment for the plaintiff is affirmed. *Catalanatto v. Coney Island and Brooklyn Railway Co.*; City Court of Brooklyn, General Term, November 25, 1889. 7 N. Y. Supp. 628.

## STREET RAILWAY NEWS.

See also "New Enterprises," "Extensions," "Elections," etc.

The following data is compiled with all possible care, but the publishers, receiving news as they do, from almost every state, territory and country, cannot be held responsible for errors, as it would be wholly impossible to obtain a verification of each item received by them in time for each issue

### ALABAMA.

**Florence**—Mr. E. J. Lawless, late Supt. of the Metropolitan Street Rwy. Co. of Kansas City, was recently here in the interest of a Kansas City syndicate, which contemplates the construction of an electric railway between this point, Sheffield and Tusculmbia.

### CANADA.

**Toronto**—The Leary Automatic Switch, a description of which appears in our advertising columns, has been adopted on the St. Rys. here.

### CONNECTICUT.

**Danbury**—From the *Standard* of Bridgeport, we quote the following:

The street railway question is now the current topic of consideration. The wildest rumors gain circulation. Several persons repaired to the expected scene of operations on Monday morning really thinking a young rebellion might be inaugurated but the war cloud drifted away. The city served an injunction on the officers of the road, and the matter will now be settled by arbitration, law or war. But as Danbury is supposed to belong to the peace conference, we confidently believe nobody will be butchered. Some active partisans have apparently exhausted their resources in attempting to prejudice the people against the road, and you will meet persons who inquire with profound gravity, as if they had a "knock down" argument, "Does the horse railway company own this city?" Well, gentlemen, after the city has granted the railway company the right to lay the road, and occupy a certain portion of the streets, don't you think they have a claim at least? About one year since the city officials gave unanimous permission to the company to make the extensions on White, West and Division streets. After the work was well under way the said officials, a minority at that, openly declared they had been cheated, and like the school boys swapping jack knives, "wanted to do it back again," so they began a system of obstructive tactics and the company took up their road and walked, declaring they did not care to force so great a public benefit upon an unwilling community. Residents along the line want the extension and confidently expect a favorable decision for the road on the law points now at issue.

**New Haven**—We understand that the Street Rwy. Company here is investigating the advisability of substituting electric for animal traction.

**Meriden**—Mr. Norman M. D. Crawford, Supt. of the electric road here, has resigned to accept the position with the Pittsburg syndicate, and we understand he will have charge of the mechanical construction of the lines in Buffalo and Rochester.

**Waterbury**—A survey is being made for the projected electric line to Naugatuck, mention of which was made in a former number of the GAZETTE.

### FLORIDA.

**Ormond**—The narrow gauge track of the horse car line is to be changed to standard gauge at once, which will be a great convenience to the guests of the Hotel Coquina.

**St. Augustine**—Survey for the projected electric st. ry., previously reported in the GAZETTE, has been made by the city engineer, Mr. Prilean.

### GEORGIA.

**Americus**—A number of the motor men employed at Americus went out on a strike lately, demanding more pay and fewer hours. Instead of having any trouble, the company followed the example lead by Gen. Geo. B. Kerper, and discharged all the strikers and filled their places with new men at once.

**Augusta**—The Richmond & Danville Co. has purchased a controlling interest in the Augusta St. Ry. for \$76,000.

**Gainesville**—News reaches us from this point that the Street Rwy. here and the Oconee White Sulphur Springs have passed into the hands of an English syndicate, of which Mr. John Martin, of London, Eng., is the representative.

**Savannah**—A syndicate of Nashville capitalists has purchased the Savannah Belt Line St. Ry. and will adopt electricity as the motive power at once.

### MAINE.

**Augusta**—The electric railway between this point and Gardiner is approaching completion.



**Bangor.**—The electric railway projected to run through Union, Hudson and Ohio streets to Cottageville, will probably be in operation before the close of the year.

#### MASSACHUSETTS.

**Beverly.**—The Beverly & Danvers Street Ry. Co. has petitioned the Danvers selectmen for permission to run over the Naumkeag Street Railway tracks in that town.

The stockholders of the Beverly & Danvers St. Ry. Co. have voted to increase the capital stock from \$13,000 to \$25,000.

**Boston.**—According to the *Boston Globe* of the 30th of last month, the holders of the franchises for the Hallbrook Street Railway are willing to "surrender the same to any reliable parties who mean business."

Work on the new Manet Electric Railway is being pushed forward to completion and the road will probably be in operation in a very short time.

**Chicopee.**—The Chicopee Street Ry. Co. has petitioned for the rights to operate its cars by electricity.

**Lawrence.**—The Boston Construction Co., of which Mr. E. P. Shaw of Newburyport, is president, has secured control of the Merrimac Valley Horse Railroad, by the purchase of 725 out of the 800 shares of stock. Electricity will be adopted as a motive power in the immediate future. That the property is undoubtedly valuable is evidenced by the fact, if we remember correctly, that last July it paid an extra dividend of 42½ per cent. from its surplus. The line is about ten and one half miles in length, and has been operating about 35 cars and 150 horses.

At a recent meeting of the stockholders of the Merrimac Valley Horse Railroad Co., it was decided to increase the capital stock from \$80,000 to \$300,000, and to issue first mortgage bonds for \$30,000.

**Nantucket.**—The electric street railway company here has asked the Railway Commissioners for the privilege of increasing its capital stock from \$60,000 to \$80,000, with the right to use \$60,000 for bonds.

#### MINNESOTA.

**Minneapolis.**—As we go to press, news reaches us from this point that the Robinson & Moan Car Works at Parker have been bought by Messrs. C. P. Jones of Minneapolis and C. Mabie of Sioux Falls. We understand that Mr. Robinson has retired from the business, but Mr. Moan will still retain a financial interest in the new company, the name of which will probably be changed to the Minneapolis Car company or something similar. It is understood that the works will be considerably enlarged and the capacity doubled.

#### NEBRASKA.

**Beatrice.**—Messrs. S. D. Mercer, J. J. Brown, W. V. Moss and Frank Murphy, all of Omaha, were recently in the city negotiating for the purchase of the controlling interest in the Beatrice Street Railway company. We understand that the system is soon to be changed from a horse railway to an electric one.

**Lincoln.**—The North Lincoln Street Railway company has decided to adopt electricity as a motive power and the Sprague system will be used.

#### NEW HAMPSHIRE.

**Nashua.**—The Street Railway company here is laying the second track.

#### NEW JERSEY.

**Fort Lee.**—Advices from Hackensack intimates that a surface cable car line between Fort Lee and Hackensack is being talked of to run during the crabbing season.

**Newark.**—By the payment of \$1,650,000 for the shares of the Essex Passenger Railway System, the Newark & Irvington Line and the Newark & Elizabeth Road all passed into the hands of a Philadelphia syndicate on the 16th of last month. We understand this does not include the Newark & South Orange and the Rapid Transit roads.

**Orange.**—A number of prominent property owners recently met in Commonwealth Hall here to protest against the enterprise of the Essex Passenger Railway company and the Suburban Railway in their attempts to obtain right of way of the streets of the township for the operation of electric cars, and a series of resolutions were

adopted requesting the township committee to extend no franchise whatsoever for any electric roads.

#### NEW YORK.

**Amsterdam.**—A number of gentlemen from New York and Philadelphia have been negotiating for the purchase of the Amsterdam Street Railway, and if successful they will convert it into an electric line.

**Binghamton.**—The new railway company, mention of which was made in a former issue of the GAZETTE, which was organized for the purpose of building the road out to the West End, has sold out to the Court Street company. Rails, ties and construction material have been purchased and the construction contract awarded, and it is expected that the line will be in operation within the next sixty days.

**New Rochelle.**—The new Rochelle & Pelham Horse Railroad has been sold to Thos. E. Crimmins for \$22,000, and the sale was made under foreclosure of a mortgage held by the Farmer's Loan & Trust company of New York for \$170,000.

**New York.**—The Court of appeals at Albany has over-ruled the decision of the lower court and granted the application of the Third Avenue Railroad company for a writ of mandamus to compel Thos. F. Gilroy, the State Commissioner of Public Works to give it a permit to open streets along the line of its road in order to change the motive power from animal to cable traction. The Railroad company has agreed to alter the conditions of the permission granted it by the Street Railway Commissioners.

Certificates of the lease of the Broadway and Seventh Avenue Railroad by the Houston, West Street and Pavonia Ferry Railroad company, have been filed.

We understand that the lease will take effect at once, but it is improbable that any outward change in the management of the companies will be noticed by anybody.

The charter of the Houston, West Street and Pavonia Ferry company is considerably broader and more liberal than that of the Broadway and Seventh Avenue, and changes can be made under that of the former that could not be brought about under that of the latter.

The capital stock of the Houston, West Street and Pavonia Railroad has hitherto been \$250,000.00, but it will now be increased to \$5,000,000.00; the Broadway line has been leased at an annual rental of 10 per cent on its capital stock, which will amount to something in the neighbourhood of \$210,000.00. For over a year it has been paying 8 per cent. dividends.

The amount of capital invested in the several lines concerned in this big deal is about as follows: The Broadway and Seventh Avenue line has \$2,100,000.00 in stock and \$2,200,000.00 in bonds; in addition to this it has guaranteed the payment of principal and interest of \$1,225,000.00 of the Broadway Surface Road, first mortgage bonds and \$1,000,000.00 second mortgage bonds; it has also obligated itself in the sum of \$350,000.00 as to first mortgage bonds of the South Ferry Loop. The Houston Street road has \$250,000.00 in stock and \$500,000.00 in first mortgage bonds.

The leasing of the two lines indicates, in our opinion, an important step toward a general consolidation of Street Railway interests in the metropolis, and the cabling of the more important ones.

**Saratoga.**—The Saratoga Electric Railroad has been granted the right to operate by electricity, only the surface Railroad between Saratoga Springs and Balston.

**Syracuse.**—The first mortgage of the Syracuse Consolidated Street Railway company amounting to \$1,250,000.00 at 5 per cent. in favour of the Central Trust company of New York has been recorded.

**Utica.**—The Belt Line company, of which Mr. W. L. Hayfox is Superintendent, has secured control of Wights Grove in Whitestown and will manage it has a picnic ground during the summer.

Messrs. Hughes and Jones have secured a contract for carrying out the changes in the Belt Line on Main Street and at Yorkville.

#### OHIO.

**Dayton.**—The Fifth Street Railroad company

of this city has increased its capital stock from \$300,000.00 to \$400,000.00.

#### PENNSYLVANIA.

**Beaver Falls.**—Some New York capitalists are negotiating for the purchase of the Beaver Valley Street Railway company and if they are successful electricity will be adopted as a motive power and the line extended to Beaver. The line has been in operation about six years.

**Greensburg.**—We understand that the Greensburg Electric Railroad will be in operation within the next 60 days.

**Phila.**—We understand that a syndicate of capitalists have organized a company known as the Fairmount Park Motor company, with Mr. Wm. Wharton, Junior, as President, for the purpose of purchasing a license for the construction of a gravity road in Fairmount Park to Mr. Win. Wharton, Junior, and the construction of the much talked of road will be put in at once.

**Reading.**—The Reading City Passenger Railway company is considering the proposition of the adoption of electricity as a motive power.

**Reading.**—The Neversink Mountain Railway which was constructed by the Equitable Electric Construction company of Philadelphia and described in a previous number of the GAZETTE will, we understand, be in full operation by the end of this month.

#### TEXAS.

**Dallas.**—The Dallas Electric Railway company has filed a petition with the council asking that its franchise be amended so as not to be compelled to permit other Street Railways operating over its tracks.

**Richmond.**—We understand that a Baltimore syndicate is now negotiating for the purchase of the Forest Hill Park and the Second Street Car lines running between this point and Manchester.

#### VIRGINIA.

**Staunton.**—A Street Railway will shortly be in operation at this point.

## NEW ENTERPRISES.

#### ALABAMA.

**Montgomery.**—A new Street Railway Company has been organized here.

#### ARKANSAS.

**Batesville.**—The Batesville City Railway Co. capitalized at \$10,000, with \$6,500 paid in, has been incorporated. The following named gentlemen are interested: Menvill Coffin, D. C. Ewing, McCurdy Hail, J. B. Fitzhugh, Theo. Maxfield and J. M. Bartlett.

#### CALIFORNIA.

**San Francisco.**—The North Beach & Mission Railway Co. has been incorporated with a capital stock of \$3,000,000, of which \$24,000 has been paid in, for the purpose of building a cable railroad. A list of the directors will be found under the head of Elections in the present issue.

#### DISTRICT OF COLUMBIA.

**Washington.**—The East Side Ry. Co. of this place has been incorporated by Julian W. Deane, M. D. Benjamin C. Pole, John W. Gregory, Geo. J. Johnson, Hallet Kilbourn, Geo T. Budd, W. R. Truxton, Marion Duckett, W. J. Johnson, Stilson Hutchins, William Hinke, L. G. Orndorff, F. J. Diendonno, A. H. Ragan, W. O. Douglass, M. A. Tappan and H. K. Willard.

#### FLORIDA.

**Jacksonville.**—We understand that another street railway will be constructed here in the near future with electricity as a motive power.

#### GEORGIA.

**Athens.**—We understand that an electric railway will be built from the business portion of the city here out to Lily Park.

**Atlanta.**—We understand that the Central R. R. will build a double line to run several miles out of the city to the Big Orchard.

#### ILLINOIS.

**Cairo.**—From the *Cairo Telegram* (regarding new electric street car franchises applied for), we clip the following: "Then, if the council is in favor of granting the franchise, and requiring the company to pay into the city treasury three per cent. of its gross earnings after five years, the ordinance could be put upon its first reading."



and laid over under the rules. Further than this, it would not be good policy to go, though it could be expedited and under a suspension of the rules adopted. If the franchise is to be granted, it may as well be done at once. The great mass of the people are in favor of it, and the sooner it is done the better they will be pleased."

**Chicago**—The Southwestern St. Ry. Co. of this city, capitalized at \$100,000, has been incorporated by Christian I. Wiehe, Thos. I. Gregory and John P. Gavin, for the purpose of constructing and maintaining a horse, dummy or cable R. R. within the city limits.

The Worrell Construction Electric Co., of this city has been incorporated by C. E. Gaylord, M. J. Frost and C. Y. White. The capital stock is \$500,000, and its purpose is the construction and maintenance of electric plants.

—The Adams Co. of this city has been incorporated with a capital stock of \$200,000 for the purpose of purchasing the control of patents, for or building or constructing electric and elevated railways.

The incorporators are: J. W. Adams, C. W. Griggs and G. M. Harris.

#### INDIANA.

**Washington**—The Citizens Street Railway Co. has been incorporated with the capital stock of \$25,000. A list of the directors will be found under the head of elections in the present issue.

#### IOWA.

**Creston**.—It is very probable that an electric railway will be built here in the near future.

#### MASSACHUSETTS.

**Attleboro**—An electric railway is projected to run from this point to Pawtucket, R. I.

**Haverhill**—We understand that a syndicate consisting of B. B. Jones, C. W. Morse and others, has been formed here for the purpose of constructing and operating a line to Lawrence.

**Lowell**—News reaches us from this point that a line is projected to run from Lawrence to Nashua, along the Centralville side of the river, to touch at Tyngs Island, but the news lacks confirmation.

#### MISSISSIPPI.

**Meridian**—The Bonita Park and the Bonita Dummy Association now has been thoroughly organized and the list of the directors of the company appears under the head of elections in the present issue.

#### MONTANA.

**Livingston**—The Livingston Street Railway Co. has been incorporated with a capital stock of \$750,000. The shares are placed at \$5.00 each. The incorporators are F. A. Ross, H. S. Potts, J. C. Vilas, E. H. Talcott, N. J. Campbell.

#### NEBRASKA.

**Mynster Springs**—Mrs. Marion Mynster of this place, has petitioned for the right of way and permission to contract, maintain and operate a line of street railway from this point to Omaha.

**Omaha**—The Northwestern Street Railway Co., capitalized at \$100,000, has been incorporated by F. Goodman, Oscar P. Goodman, H. J. Penfold, Hiram G. Bell and Joseph Bell.

#### NEW JERSEY.

**Asbury Park**—The Sea Shore Street Railway Co., backed by New York capitalists, has been organized for the purpose of constructing and operating an electric railway between this point and Avon by the Sea.

**Elizabeth**—The Union County R. R. Co. (virtually a branch of the Philadelphia syndicate), has been granted a valuable franchise for the construction and operation of between four and five miles of street railway through the northern and western parts of this city.

**Long Branch**—It is rumored that an electric railway will be built between this point and Red Bank in the near future.

**Monmouth**—The Monmouth Street Railway Co., capitalized at \$48,000.00, has made application for the right of way for an electric line over the West End to Pleasure Bay.

**Newark**—The North American Company has been chartered with a capital stock of \$50,000.00, of which \$12,000.00 has been subscribed for. Edward Q. Keasey of Newark, Charles L. Borgmeyer of Rahway, and C. N. Williams of Summit, have subscribed this amount. The principal place of business of the company in this state

will be at Newark, but it will transact business in all states and territories, in South America, Canada, Europe, and elsewhere.

The object of the corporation is to form and promote the formation of railways, street railways, steamship, electric light and electrical apparatus companies; to deal in stocks, securities, franchises, &c.; to act as agent for corporations, individuals, states, or municipalities in the negotiation of stocks, obligations, &c.; to operate telegraphs and telephones, gas, water and oil works; to mine for all kinds of ores; to carry on transportation business of every character, and for the transaction of all business necessary to the accomplishment of these objects.

#### NEW YORK.

**Auburn**—The Auburn City Railway Company has been granted a franchise to run the surface railway out to Owasco Lake.

**New York City**—The Broad Street Railway Co. has been incorporated with a capital stock of \$300,000.00 for the purpose of constructing and operating a street railway commencing at South Ferry, running thence with a double track along White Hall south to Broad street, with a single track through Wall, William, and N. William along Park Row and Nassau street, to junction with the westerly track on Broad street.

A branch line will also be constructed beginning at Spruce and William streets and running through Spruce street with a single track to Nassau street, and thence, with a double track, along Printing House Square and Mail street to the termination of Mail street, near Broadway, which branch will connect with the single tracks in William and Nassau streets.

A list of the directors and officers of the company will be found under the head of elections in this issue.

#### NORTH CAROLINA.

**Asheville**—We understand northern capitalists will build eight miles of double line here to be completed by the last of this year. The capital stock of the company will be \$100,000.

**Marion**—The Marion Hotel and Street Railroad Company say that if permission is granted it over certain streets it will commence the construction of a street railway at once, and have one and one-quarter miles in operation within six months.

**Oxford**—R. T. Grady, C. M. Hawkins, P. M. Wilson and others of Raleigh, John A. Hambleton & Co., of Baltimore, Md., and E. C. Hernon of this place have organized a company for the purpose of constructing and operating a street railway line here.

#### OHIO.

**Cleveland**—The Fremont Street Railway Co. has increased its capital stock from \$100,000.00 to \$150,000.00.

**Sandusky**—The following communication was recently received by the City Solicitor:

GENTLEMEN—Having purchased the Sandusky street railway from its former owners, and being desirous of improving and extending said railway, we respectfully beg your honorable body to amend the existing street railway ordinances so as to restore the sections relating to the routes to the Soldiers' and Sailors' Home, changing the limit of time in which one of said routes shall be completed to November 1st, 1890, and limiting all other routes to three years from the passage of the amendment.

It is our intention to equip the lines with electricity, new cars, and make a first-class system throughout, and as it is extremely important that we place our orders for cars, motors, dynamos, engines, etc., immediately, so as to make the improvements this summer, we sincerely hope that you will aid us in giving to Sandusky a street railway system of which its citizens can be proud. Yours very truly,

CHARLES E. COOK,  
C. W. FOOTE,  
WILL CHRISTY,  
JAS. CHRISTY, JR.

It was received and referred to the committee on streets.

**Sidney**—The Sidney Street Railway Company has been incorporated with a capital stock of \$25,000.00.

**Toledo**—The Consolidated Street Railway company has received permission from the coun-

cil to make a double track on Erie Street from Monroe to Washington and on Washington to Ontario.

#### PENNSYLVANIA.

**Pittsburg**—A new corporation here is the North Allegheny Electric Railway company. It has been granted the right of way to several streets and will probably build its line in the immediate future. Among the incorporators may be mentioned the names of James W. Breen, Henry Schwitzer and Geo. Smanan. The line will be about one mile in length when completed.

We understand that an application has been made by the West End Passenger Railway company for permission to construct and operate an electric street railway from Mansfield Valley through Crafton, Idlewood and Ingram to connect with Temperanceville. Electricity will be the motive power and the line from the foot of Fifth Avenue and West End will very shortly be operated by electricity instead of by horses.

**Reading**—It is understood that an electric railway will soon be built between this point and Bernville. The old Union Canal to be utilized as a road bridge.

#### SOUTH CAROLINA.

**Greenville**—A franchise has been granted for the construction of a street railway in which upwards of \$300,000 will be invested.

A franchise has also been granted to the incorporators of the Greenville Dummy line over certain streets and out to Paris Mountain.

#### SOUTH DAKOTA.

**Huron**—A franchise has been granted to Mr W. T. Love for a franchise over the streets here.

#### TENNESSEE.

**Dayton**—It is said that the street car line will be built in this point to Nelsonville in the immediate future.

#### TEXAS.

**Dallas**—The Dallas Cable Railway company, capitalized at \$600,000, has been incorporated by J. M. Harry, H. W. Harry, T. C. Harry, Thomas Field, Frank Field, J. W. Guild, A. W. Childress, T. W. Griffiths, C. E. Keller, C. H. Cooper and T. J. Wood, all of Dallas, and J. M. Thompson of San Francisco.

#### VIRGINIA.

**Roanoke**—A dummy line between Roanoke and Salem is now regarded as settled.

#### WASHINGTON.

**Puyalop**—The Tacoma & Puyalop Electric Street Railway Co. proposes to run an electric road from this point to Tacoma, provided a subsidy of \$30,000 is raised for it. Inasmuch as \$29,000 has been subscribed, it looks very much as though the road would be built.

**Seattle**—The Metropolitan Land Co., capitalized at \$60,000, has been incorporated by E. F. Wittler, John Leary and W. H. Llewellyn, for the purpose of building and equipping lines of street railway in Seattle.

The Rainier Power and Railway Co. has presented an ordinance to the Council for the construction of an electric railway here.

The James Street Construction Company, capitalized at \$200,000 has been incorporated for the purpose of building and acquiring street railways here. The incorporators are E. F. Wittler, John Leary, W. H. Llewellyn.

#### WEST VIRGINIA.

**Benwood**—A charter has been granted to a number of gentlemen who have organized a corporation which will be known under the name of the Benwood Southern Street Railway Co. It is the intention of the company to construct and operate a street railway between this point and Montsville.

#### WISCONSIN.

**Milwaukee**—The Layton Park Street Railway Co. of this city, has been incorporated with a capital stock of \$10,000. The incorporators are Fred T. Day, Wm. Sanderson and James H. Thomas.

The Wauwatosa & Soldiers' Home Street Railway has been incorporated for the purpose of constructing and operating street railways in Milwaukee, Wauwatosa and Greenfield. The capital stock of the company is \$40,000 and the incorporators are Charles Cuppel, Martin P. Carpenter, Frank R. Falk, N. S. Murphy, John Johnston, George Van Norman, Jacob Aubli and John Le Fedor.



## ELECTIONS.

**Atlanta, Ga.**—At a recent meeting of the Atlanta Street Railway Co. which now controls all the horse car lines in the city, the following named gentlemen were elected as officers:

President—Hon. W. A. Hemphill.

Secy.—J. W. Culpepper.

Supt.—W. S. Larendon.

Attorney—Judge John L. Hopkins.

Directors—W. A. Hemphill, Paul Romare, James Swan, J. W. Culpepper, A. E. Thornton, M. Frank and H. O. Sexios.

**Holyoke**—A strong probability exists that the control of the Holyoke Street Railway Co. will soon pass into the hands of Springfield capitalists immediately connected with the Springfield Street Railway Co. It is an actual fact that a large block of the capital stock of the Holyoke Co. has passed into the hands of the Springfield men, and it is more than likely that a consolidation of the two interests will shortly be effected. The present Holyoke Street Railway Co. was organized June 11, 1884, and its capital stock is \$50,000. The new officers of the Holyoke Street Railway Co. are: President, Levi Perkins; Clerk, W. H. Brooks; Treasurer, W. S. Loomis; Directors, Levi Perkins, R. B. Johnson, C. H. Heywood, C. H. Prentiss, J. F. Sullivan, J. G. Mackintosh, L. M. Tuttle, W. S. Loomis and Philander Moore.

**Indianapolis, Ind.**—At the annual meeting of the stock-holders of the Citizens Street Railway Co., the following named gentlemen were elected as officers and directors for the ensuing year.

President—J. C. Shaffer.

Vice-President—Samuel W. Allerton.

Secy.—A. A. Anderson.

Supt.—Wm. T. Steele.

Directors—Samuel W. Allerton, J. J. Mitchell, E. K. Butler, W. B. Walker of Chicago and J. C. Shaffer of Indianapolis.

**Lawrence, Mass.**—The new officers of the Merrimac Valley Street Railway Co. which has now passed into the control of the Boston Construction Co. are as follows:

President—E. P. Shaw.

Treasurer—Jas. H. Eaton.

Directors—E. P. Shaw, Jas. H. Eaton, Wilard P. Ferguson, John H. Cunningham, Wm. Oswald.

**Merrimac**—At the recent meeting of the stockholders of the Merrimac Street Railway Co., the following named gentlemen were elected as directors of the company, E. P. Shaw, Wm. B. Ferguson.

**Meridian, Miss.**—The following named gentlemen constitute the board of directors of the Bonita Park and Bonita Dummy Line Association, reference to which is made under the head of street railway news in the present issue. J. H. Wright, J. H. Walker, J. S. Solomon, C. C. Coffee, A. J. Weems, W. W. George and W. N. King.

**Newark, N. J.**—At the first meeting of the Newark Street Railway Co. recently organized by the Philadelphia syndicate, the following Newark directors were elected: Thos. C. Barr, A. Q. Keasbey, A. L. Dennis, Andrew Lemassena, who with several new directors, connected with the syndicate, will comprise the new board of directors.

**New York, N. Y.**—At the recent meeting of the 23d Street Railroad Co., the following named gentlemen were duly elected as officers and directors for the ensuing year:

Prest.—William L. Elkins.

Vice-Prest.—P. A. B. Widener.

Sec.—Thomas H. McLean.

Treas.—Walter T. Hatch.

Board of Directors—William L. Elkins, Wm. H. Kemble, P. A. B. Widener, Daniel S. Lamont, Thomas F. Ryan, D. B. Hasbrouck, Charles E. Warren, Henry Thompson, Thomas H. McLean, Sol Mehrbach, A. S. Rosenbaum, S. U. Caldwell, Walter T. Hatch.

Inspectors of Election—William J. Ramsey, E. J. Mathews, J. J. Swan.

The first board of directors of the recently incorporated Broad Street Railroad Co., (details of which will be found under the head of new enterprises in this issue) are Harry B. Col-

lins of Islip, L. I., Robert L. Cutting, Harry K. Knapp, William F. Havemeyer and Charles C. Eddy of New York city, Robert A. C. Smith of Brooklyn, and H. J. Nichols of Babylon, L. I.

The new board of directors of the Broadway and 7th Avenue road is as follows: Henry Thompson, Thomas F. Ryan, D. B. Hasbrouck, P. A. B. Widener, W. L. Elkins, John H. Murphy, Thomas J. L. Donohue, D. S. Lamont, C. F. Frothingham, W. H. Rockwell, W. B. Dinsmore, Charles Banks and John J. Bradley.

**Rochester, N. Y.**—At a recent meeting of the stockholders of the Rochester Electric Railroad Co., the following named gentlemen were duly elected as directors, etc.: Directors—John N. Beckley, M. H. Briggs, A. Luetchford, W. C. Barry, M. A. Verner, H. S. McKee, S. Stace, E. T. Curtis, J. B. Perkins, J. M. Whitney, C. M. Everest, C. S. Baker, C. F. Pond.

Inspectors of Election—John Alexander, Merton E. Lewis, H. F. Remington.

**San Francisco, Cal.**—At the recent meeting of the stockholders of the Sutter Street Railway Co., the following gentlemen were elected as officers, etc.:

Prest.—R. F. Morrow.

Vice-Prest.—J. L. Schmitt.

Sec.—A. K. Stevens.

Treas.—Maurice Schmitt.

Directors—R. F. Morrow, J. L. Schmitt, Jos. Naphthal, R. G. Byxbee and E. Durbrow.

At a meeting of the North Beach & Mission Railway Co., recently incorporated, the following named gentlemen were elected as directors for the first year: James A. White, Henry G. Meyer, G. Ruegg, James T. Boyd and Frank T. Hoburg.

**Washington, Ind.**—The first Board of Directors of the recently incorporated Citizens' Street Railway Co., are as follows: Zachariah Jones, Austin F. Cable, Wm. W. Marmaduke, Thomas J. Axtell and John C. Billheimer.

## EXTENSIONS.

**Biddeford, Md.**—The Street Car Line here will probably be extended in the near future, that is as soon as certain new streets are opened up.

**Beatrice, Neb.**—We understand that the Beatrice Street Railway company is to be considerably extended in the near future.

**Garden, N. J.**—It is highly probable that the Camden Horse Railroad company will extend its line to Merchantville and elsewhere in the immediate future.

**Gainesville, Ga.**—We understand that the Street Railway here will be extended to White Sulphur, a distance of six miles in the near future.

**Laconia, N. H.**—The Belmont Line will probably be extended in the near future.

**Plymouth, Mass.**—It is probable that the Plymouth and Kingston Railway company will extend its line considerably before very long.

**Richmond, Va.**—If the Baltimore syndicate, which is now negotiating for the purchase of the Forest Hill Park and the Second Street Car Lines, operating between this point and Manchester, is successful each of the lines will be extended out to the park.

**Toledo, O.**—The Consolidated Street Railway company has received permission to extend its tracks along the river road, Fawcett Street, to the Brown road, and east Toledo.

**Wilmington, Del.**—It is highly probable that the Wilmington City Railway company will extend its lines to South Wilmington in the near future, an application for the extension has been signed by the majority of the property owners and there will probably be but little opposition to the project.

## Patents.

The following is a list of such patents as relate to street railway interests, issued between June 3, and June 29, especially prepared for the STREET RAILWAY GAZETTE by Messrs. Higdon & Higdon, solicitors of patents and trade marks, room 36 LeDroit building, opposite U. S. Patent Office, Washington, D. C. A printed

copy of any patent here named will be furnished by them for 25 cents (stamps).

*Issue of June 3, 1890.*

429,413. Trolley for Electric Railways, Warren S. Blauvelt, assignor, to Sea Shore Electric Company, Asbury Park, N. J.

429,113. Trolley-Carrier, Benjamin F. Brown, Boston, Mass.

429,277. Electric Tramway and Car, Alexander L. Lineff, Chiswick, county of Middlesex, England.

429,199. Electric Railway System, William D. MacQuesten, New York, N. Y.

429,314. Continuously-Operated Electric Motor, William D. MacQuesten, New York, N. Y., assignor to C. L. Edgar, trustee, Boston, Mass.

429,315. Insulator for Electric Railways, William D. MacQuesten, New York, N. Y., assignor to C. L. Edgar, trustee, Boston, Mass.

429,316. Tension-Bracket for Trolley-Wires, William D. MacQuesten, New York, N. Y., assignor to C. L. Edgar, trustee, Boston, Mass.

429,590. Cable-Grip, Joseph H. Masters, Chicago, Ill.

429,478. Interlocking Electric Railway System, Joseph Ramsey, Jr., and F. C. Weir, Cincinnati, Ohio.

429,327. Electric Railway Motor, Frank J. Sprague, assignor to Sprague Electric Railway and Motor Company, New York, N. Y.

429,490. Field-Magnet for Dynamos, Edmund Wagemann, assignor of six-sevenths to J. D. and D. Adams, O. and J. W. Davis, H. G. Allis and J. B. Jones, Little Rock, Ark.

*Issue of June 10, 1890.*

429,804. Traction-Motor, James S. Baldwin, assignor to S. H. Baldwin, Newark, N. J.

429,790. Cable-Grip, Elias R. Guerra, Hacienda de San Matias, Jalisco, Mexico.

429,687. Electric Railway, Rudolph M. Hunter, assignor to Electric Car Company of America, Philadelphia, Pa.

430,025. Electric Railway, Rudolph M. Hunter, assignor to Thomson-Houston Electric Co., of Connecticut.

430,076. Electric Railway, Rudolph M. Hunter, Philadelphia, Pa., assignor by mesne assignments, to Thomson-Houston Electric Company, Boston, Mass.

430,026. Carriage Door, John F. Hurtig, Saint Louis, Mo.

429,946. Machine for Turning Dynamo Commutators, Horace G. McLean, McPherson, Kansas, assignor of one-third to E. C. Heggelund.

429,736. Dynamo-Electric Machine, Richard Pfund, Brooklyn, N. Y.

429,869. Automatic Switch for Cable Railways, Houghton Sawyer, San Francisco, Cal.

430,094. Tool for Truing Dynamo Commutators, Allen D. Spencer, assignor of one-third to R. M. Wallace, Baltimore, Md.

429,746. Electric Railway Motor Truck, Chas. J. Van Depoele, Lynn, Mass.

429,981. Electric Railway Conductor System, Charles J. VanDepoele, Lynn, Mass.

*Issue of June 17, 1890.*

430,412. Cable Grip, James C. Anderson, Highland Park, Ill.

430,263. Signal for Electric Railways, Edward M. Bentley, Washington, D. C.

430,109. Conduit for Cable Railways, Andrew Bryson, Jr., New York, N. Y., and J. H. Pendleton, Brooklyn, N. Y., assignors to Rapid Transit Cable Company, of New York.

430,117. Station Indicator, Sylvanus B. Crane, Oxford Junction, Iowa.

430,515. Electric Railway, Daniel B. Devore, United States Army

430,118. Street Railway Switch, Philip B. Downing, Boston, Mass.

430,178. Cable Suburban Railway, Charles E. Emery, Brooklyn, N. Y.

430,179. Cable Suburban Railway, Charles E. Emery, Brooklyn, N. Y.

430,180. Cable Suburban Railway, Charles E. Emery, Brooklyn, N. Y.

430,208. Electric Railway, Rudolph M. Hun-



ter, Philadelphia, Pa., assignor by mesne assignments to Thomson-Houston Electric Company, Boston, Mass.

- 430,580. Electric Railway, Rudolph M. Hunter, Philadelphia, Pa., assignor to Thomson-Houston Electric Company of Connecticut.  
 430,188. Street Railway Switch, William H. Koehler and M. Roskoph, Cleveland, O.  
 430,232. Cable Railway and Cable, Hosea W. Libbey, Boston, Mass.  
 430,140. Cable Railway Brake, Charles S. Moss, Kansas City, Mo.  
 430,147. Electric Car, Louis Pfingst, Boston, Mass.  
 430,327. Regulator for Dynamo-Electric Machines, Elihu Thomson, Lynn, Mass.  
 430,328. Alternating Current Motor, Elihu Thomson, Lynn, Mass.  
 430,329. Electric Railway, Merle J. Wightman, Hartford, Conn.

Issue of June 24, 1890.

- 430,629. Automatic Clutch for Car-Starters, Ezra Dederick, Milwaukee, Wis.  
 430,634. Regulator for Dynamos, William H. Elkins, Boston, Mass.  
 430,660. Gear for Driving the Winding Drums of Cable Railways, Gabriel Leverich, South Orange, N. Y.  
 430,675. Trolley Carrier, David C. Nelson, Quincy, and W. R. Eaton, Cambridge, Mass.  
 430,686. Switch for Electric Locomotives, Frank B. Rae, assignor to Detroit Electrical Works, Detroit, Mich.

#### Expiring Patents.

The following patents will shortly be public property and may be used by any one.

Manufacturers may determine to what extent they may act independently of patent rights, and inventors may gain an insight into the prior state of the art by consulting copies of them.

A printed copy of the drawings and specifications of any of the following will be furnished by Messrs. Higdon & Higdon for 25 cents.

Expiring During July, 1890.

- 140,433. Street Railroad Switch, J. E. Pattison.  
 140,669. Fare Box, H. Barranger.  
 140,972. Street Car Awning, C. B. Turnbull.  
 140,781. Car Starter, T. W. Johnston.  
 140,950. Fare Box, R. D. O. Smith.  
 140,985. Fare Box, J. W. Winchell.  
 141,459. Car Starter, C. J. Moore.  
 141,326. Car Starter, J. Corbeil.  
 141,217. Rail for Street Railways, M. L. Ghirardina.

NATIONAL ELECTRIC LIGHT ASSOCIATION.—Mr. Allan V. Garratt, Secretary and Treasurer of the National Electric Light Association, has sent out two circulars to members in reference to matters connected with the next convention of this association. Two classes of questions are asked in the circulars

1. Are you willing to furnish a paper for the August Convention, to be held at Cape May? If so, on what subject?

What subject would you suggest for the committee to endeavor to secure a paper on?

Who would you suggest as most desirable to furnish a paper on the above subject?

2. Are you operating electric light or power through underground conductors?

Are you willing to furnish this Association information about same? (Names to be kept private, if so desired.)

Papers must be in the hands of the Committees on Papers and Underground Conduits and Conductors by July 3d next.

Mr. J. E. Lockwood, 21 Rowland street, Detroit, Mich., is the chairman of both committees, to whom replies to the questions should be sent in order to save time.

#### Acknowledgment.

We are indebted to the *Western Electrician* for the cuts and description of the Indianapolis power station, etc., shown in this issue.

The Walker Manufacturing company of Cleveland, O., has furnished forty-two of its celebrated differential drums throughout the country, and has twenty-two more now in hand.

A record like this is conclusive evidence of the increasing favor with which cable engineers throughout the country are regarding these differential drums.

Of the drums supplied we are informed that no less than fourteen were to displace solid drums at various points, as follows:

Two at St. Louis, St. Louis Cable & Western Railway company.

Two at St. Louis, Citizen's Cable Railway company.

Two at Grand Rapids, Valley City Street & Cable Railway company.

Eight at Denver, Denver Tramway company.

All these drums are giving the best of satisfaction wherever used, and the demand for them is still increasing.

The following is a copy of the writers of commendation received by the Walker Manufacturing company, regarding its cable machinery, and which are self-explanatory:

OFFICE OF CITIZEN'S CABLE RAILWAY,  
ST. LOUIS, MO.,  
ST. LOUIS, MO., JUNE 18, 1890.

THE WALKER MANUFACTURING CO.,  
CLEVELAND, OHIO.

GENTLEMEN:—Our new machinery is working fine; we have gained thirty seven (37) horse power by making the change from solid to your differential drums. We are driving with three (3) wraps, and I am satisfied that we could drive our other two ropes with two wraps with the same device. I don't think it will be a great while before we change our other machinery to use your differential drums. Mr Moffitt, president of the Olive street line, came to see the machinery working and he praised it very highly, and says your differential drums are the proper thing for driving a cable.

Yours,  
(Signed.) FRANK YARD,  
Chief Engineer.

PORTLAND CABLE RAILWAY COMPANY,  
PORTLAND, OREGON.  
PORTLAND, ORE., JUNE 20, 1890.

THE WALKER MANUFACTURING CO.,  
CLEVELAND, OHIO.

GENTLEMEN:—We are pleased to say that the machinery in its entirety is simply perfect; we are more than proud of it, and claim that our road is the best on this coast, excepting none.

Respectfully,  
(Signed.) PORTLAND CABLE RAILWAY CO.,  
By GEO. W. LYNCH, Gen. Man'r

#### Business Note.

A. L. Ide & Son, Springfield, Ill. report the following sales and shipments of their Ide and Ideal Engines: Wm. Barr Dry Goods Store, St. Louis, Mo., 50 h. p.; The Prescott Co., Atlanta, Ga., 35 h. p.; Marinette Iron Works, West Duluth, Minn. 35 h. p.; City of Newton, Iowa, 100 h. p.; Moffett, Hodgkins & Clarke, La Grange, Ill., 65 h. p.; Minonk Electric Light and Power, Co., Minonk, Ill., 35 h. p.; Union Rapid Transit Co.; Salt Lake City, Utah, 250 h. p.; Minnesota Institute for Defectives, Faribault, Minn., 65 h. p.; Browning, King & Co., Minneapolis, Minn. 35 h. p.; Mansfield Machine Works, Mansfield, Ohio, 100 h. p.; Chicago City Railway Co., (2d order) Chicago, 80 h. p.; Peter Schmidt, Milwaukee, Wis., 80 h. p.; Springfield Electric Light and Power Co., Springfield, Ill., (2) 125 h. p.; Nordyke & Marmon Co., Indianapolis, Ind., 65 h. p.; English, Morse & Co., Kansas City, Mo., two forty and one fifty h. p.; N. P. Railway, Cincinnati, Mon., 50 h. p.; Camden Electric Light and Power Co., Camden, Ark., 80 h. p.; J. A. Fay & Co., Chicago, Ill., 35 h. p.; Creston, Gas and Electric Light Co., Creston, Iowa, 100 h. p.; Ft Wayne Electric Co., Ft Wayne Ind., 65 h. p.; Riverton Land Co., Sheffield, Ala., 35 h. p.; Texas Ice and Cold Storage Co., Galveston, Texas, 10 h. p.; Pittsburgh Gas Light Co., Pittsburgh, Kan., 125 h. p.; Findlay Electric Light and power Co., Findlay, O., 100 h. p.; Colorado Electric Supply and Motor Co., Denver, Colo., 15 h. p.; Shreveport St Railway and Land Co. Shreveport, La., 150 h. p.; Thomson-Houston Electric Co., Clinton, Ia., 150 h. p.

The Equitable Electric Railway Construction company of Philadelphia is installing the entire plant for the Richmond & Southern Electric Railway at Richmond, Va. The road is double track, about five miles long, running from the locomotive

works in Richmond over Seventh street, and across the new bridge into Manchester and Woodland Heights. The overhead work is of the most substantial character. Octagonal yellow pine poles 18 inches in diameter are used, and each pole has iron steps on its side for convenience in climbing. The regular Sprague overhead system is being used. There will be five vestibuled Brill cars, each equipped with fifteen horse power Smet motors of the regular type. Patent noiseless wooden tooth gearing, built by the Equitable Electric Railway Construction company, will be used on these cars. The power house is being equipped with one 80,000 Watt-Edison compound generator driven by a Ball high speed engine of 100 horse power. The contract for the entire equipment of this road, exclusive of the track, including power station, cars, engines, boilers, etc., was given the Equitable Electric Railway Construction company, and it is pushing the same forward with no waste of time.

#### Literary Notes.

The July number of the *National Magazine* of Chicago will open with an article entitled "Harvard University and Reform," by Chancellor Harkins of the National University of Chicago, in which the wisdom of President Eliot's radical recommendations is forcibly maintained. Other timely articles are:—"Plan Proposed for a Polytechnic Institute," "Biblical Literature," by Rev. J. C. Quinn, LL. D., "College Courses for Non-Residents," "Union College Examinations" and Honorary Degrees." Young men will be interested in the article on the "Chicago Trade Schools." Particulars of the recent gift of twenty-five acres of land near Chicago, worth \$25,000, to the National University and of its proposed new building thereon are also given in this number. Published at No. 147 Throop Street, Chicago, Ill. Sample copy 10 cents.

PRACTICAL BLACKSMITHING. A collection of articles contributed at different times by skilled workmen to the columns of "The Blacksmith and Wheelwright," and covering nearly the whole range of blacksmithing, from the simplest to some of the most complex forgings. Compiled and edited by M. T. Richardson, Editor of "The Blacksmith and Wheelwright." Illustrated. Vol. II. Price, \$1.00. M. T. Richardson, Publisher, New York.

In Vol. I. of this series the editor gave a brief account of the early history of blacksmithing, described many ancient and modern tools, with numerous plans of shops and the best methods of building chimneys and constructing forges. The volume before us opens with a brief treatise on the early history of iron and steel. Artistic iron work is then touched upon and the tests employed to show the strength of iron are given. The remainder of the volume is made up of a great variety of tools for blacksmiths, many of them of special design and peculiar construction. An entire chapter is devoted to Bolt and Rivet Clippers, numerous illustrations with descriptions of these tools being given. Then there is a chapter on Chisels, how to make and how to grind them. Another on Drills and Drilling; another on Fullering and Swaging, with numerous illustrations of special styles of Fullers. There are two chapters on miscellaneous tools; another chapter on Blacksmiths' Shears, and a concluding chapter on Emery Wheels and Grindstones. Altogether the book contains 230 illustrations. It would seem to be of almost incalculable value to every blacksmith. Volume III, the editor announces, will give illustrations with descriptions of a great variety of jobs of work.

Marion Harland, the friend and helper of women everywhere, has taken up the work of restoring the ruined monument marking the burial place of MARY THE MOTHER OF WASHINGTON. She says truly—in her appeal to the mothers and daughters of America to erect a fitting monument to her who gave Our Country a Father—that "the sun shines upon no sadder ruin in the length and breadth of our land, than this unfinished structure."

The publishers of *The Home-Maker*, of which Marion Harland is the editor, offer, as their contribution to the good cause, seventy-five cents out of every annual subscription of two dollars to the magazine, sent in during the next six months. Every such subscription must be accompanied by the words, "For Mary Washington Monument."

The offer is generous, and should meet with enthusiastic response.



# The Street Railway Gazette.

(Copyrighted 1890.)

Vol. V.

CHICAGO.

AUGUST, 1890.

CHICAGO.

No. 8

## ELECTRIC RAILWAYS.

### The Fishkill Corliss Engine.\*

In the accompanying illustrations the latest design of the engine is shown, together with drawings of some of the details. Fig. 1, shows the engine complete, which is of the original Corliss type, somewhat modified to more fully meet the requirements of engineering practice of to-day. The girder frame with which the engine is provided, is specially designed for com-

works. The legs which support the cylinder, are sufficiently massive to furnish the necessary strength and rigidity, and at the same time giving a large bearing surface upon the foundation. Two of the legs are extended to furnish bases for the support of the dash-pots, which insures their remaining perfectly in line, and at the same time, keeping them above the floor where all portions are readily got at.

In the cylinder, the clearance space is kept at the lowest limit, reducing the loss at this point as much as possible, while in the larger sizes of en-

each figure and refer to the same parts. *A* is the valve stem to which the lever arm *B* is keyed; this carries at its outer extremity, the hard steel catch-plate *C*. (Fig. 3.) To this lever, *B*, is attached the connection to the dash-pot. The wrist-plate connection, *X*, is attached to the double armed lever *CC*, which works loosely on a sleeve round the stem, the arm *C* carrying at its outer extremity a small rock shaft *D*. This rock-shaft has attached to it at one end the hook *E*, and at the other the arm *F*, carrying the hardened steel roller *R'*. The

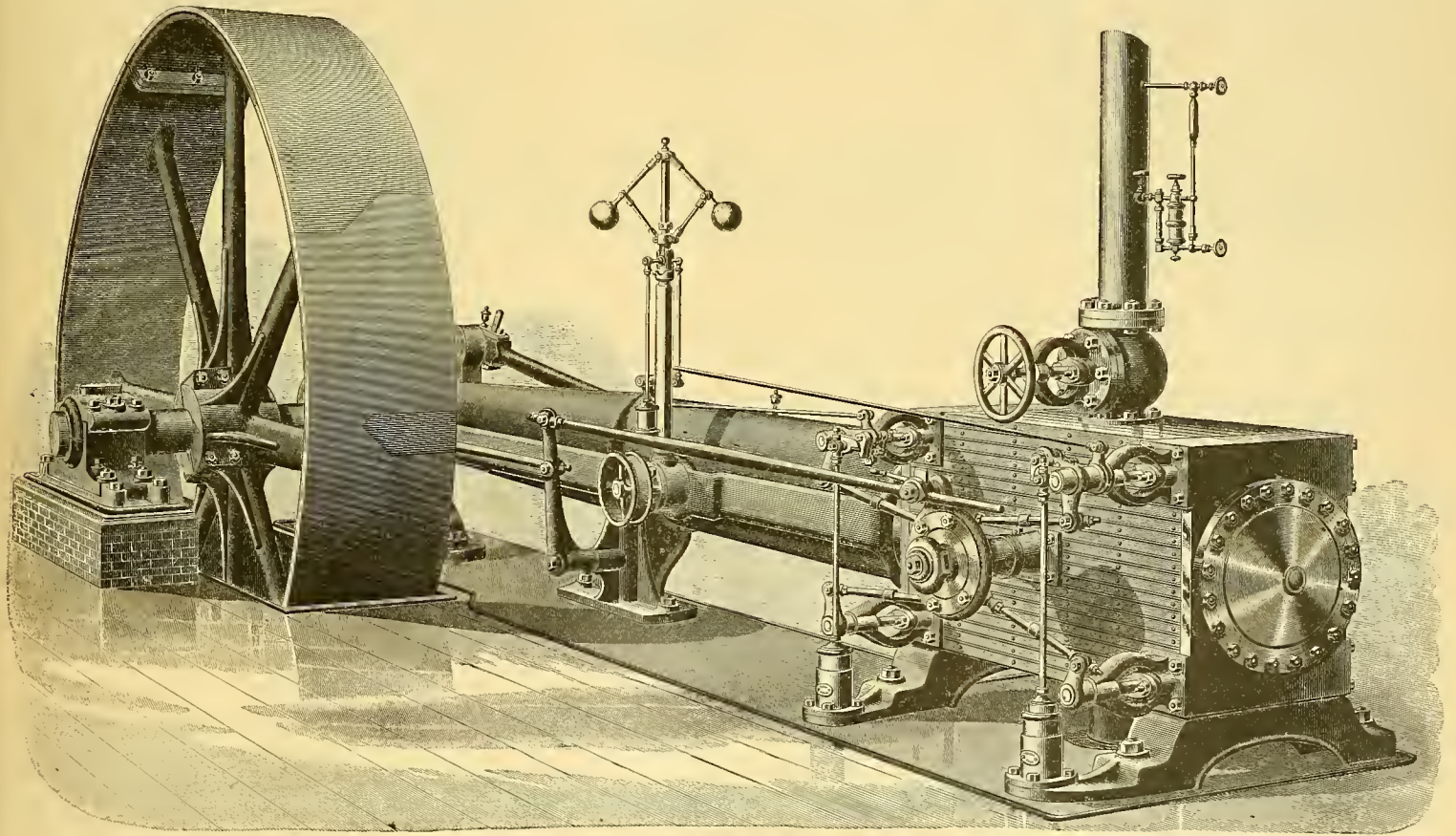

FIG. 1.—THE FISHKILL CORLISS ENGINE—BACK VIEW.

compactness and rigidity, the disposition of the metal which it contains being made in such a way that the greatest amount of strength is obtained from the least weight of metal. The supports under the frame are of such shape and so disposed as to prevent swaying and twisting, by this means securing absolute rigidity in the parts supported, while the strength of the various parts is amply sufficient to withstand all strains that they will ever be called upon to endure while working at their rated capacity. By these means, continual alignment is secured. The center support to the frame serves also as a support for the pin upon which the rocker arm

gines, the exhaust passages are made separate from the body of the cylinder. These engines are sufficiently well known to make it unnecessary to speak of the workmanship put upon them, or of the quality of the materials used in their construction.

This company has, until recently, been using a releasing gear, known as Cité's, of which the present gear is a modification. The detail cuts show the new features employed, which may be clearly understood from the following descriptions: Figs 2, 3, and 4, show the mechanism of releasing the valve gear; Fig. 2, being an elevation from the side next the cylinder; Fig. 3, being a view from the opposite, or outside, and Fig. 4, is a plan. The letters of reference are similar in

spring *f* tends to keep the hook *E* in towards the stem, where it can engage with the catch-plate *c*, Fig. 2 showing them thus in engagement when the valve is about the middle of its stroke. This engagement continues until the roller *R'* comes into contact with the roller *R*, when the hooks will commence to disengage. The actual release does not take place, however, until roller *R'* has passed upwards far enough to be very nearly in the radial line drawn from the center of stem through the center of roller *R*, thus at the moment of release exerting practically no force tending to disturb the governor, which, of course, determines the position of roller *R*. The governor connection *Z* is attached to an arm *H*, this arm being upon a

\* Fishkill Landing Machine Company, Fishkill-on-the-Hudson, N. Y.



ring which is turned by the action of the governor, and carries two other arms *H'* and *H''*, the latter carrying a can *W* which serves the

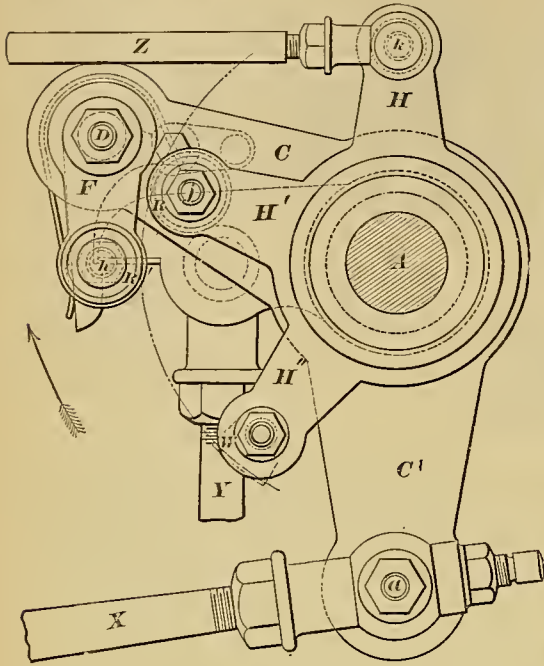

FIG. 2.

purpose of an automatic stop. The can *W* is adjustable, and when the engine is at its lowest normal speed, and the hook *E* is at the point of engagement with the valve lever *B*, the roller *R'* comes nearly in contact with the cam. Now should the governor belt be broken, or if from any other cause the governor balls should fall below the point corresponding to the lowest normal speed, the bell crank *H* will move in the direction of the arrow: and the roller *R'* coming in contact with the cam, the hook is prevented from engaging, and, the valve remaining closed, the engine stops. By a simple device attached to the governor column the action of this stop may be suspended by the engineer at any time, as, of course, it is necessary that it should be in start-

which is a working fit in both bores. This plunger is connected with the valve lever by the rod *C*, having a ball joint, as shown. The plunger is shown in the middle of its stroke, and, supposing it to be moving upwards, as it is when the valve is being opened, a chamber *y* is formed under it. This chamber is connected by the passage *e e'* with the annular chamber *x*, in which the contained air would be compressed by the upward movement of the plunger, were it not for the connecting passage *e e'*. But as the chamber *y* is so much greater in area than chamber *x*, the air is rarefied in both chambers, the degree of vacuum increasing with the rise of the plunger. When cut-off takes place the atmos-

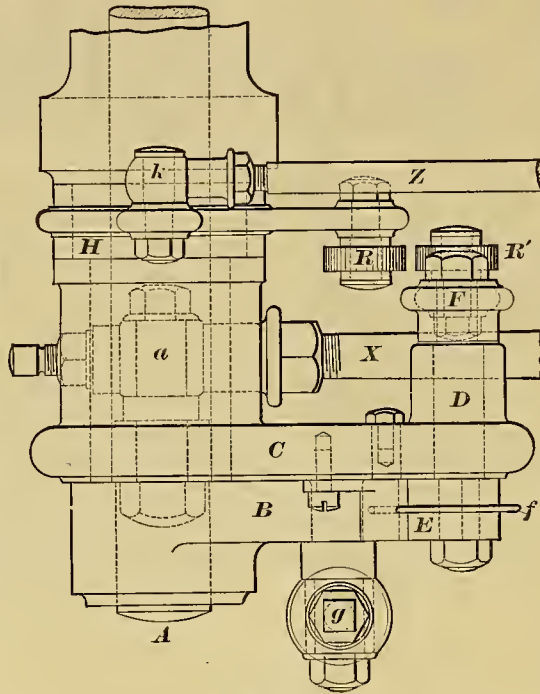

FIG. 4.

pheric pressure causes the plunger to descend rapidly, the partial vacuum formed in chamber *x* increases, while the rarefied air in chamber *y*, finding an obstruction in passing through the

other alternately, its action is entirely without noise. The cock *v* can be set to secure any desired action of the dash-pot, which as will be seen, is simple and very quick in its action.

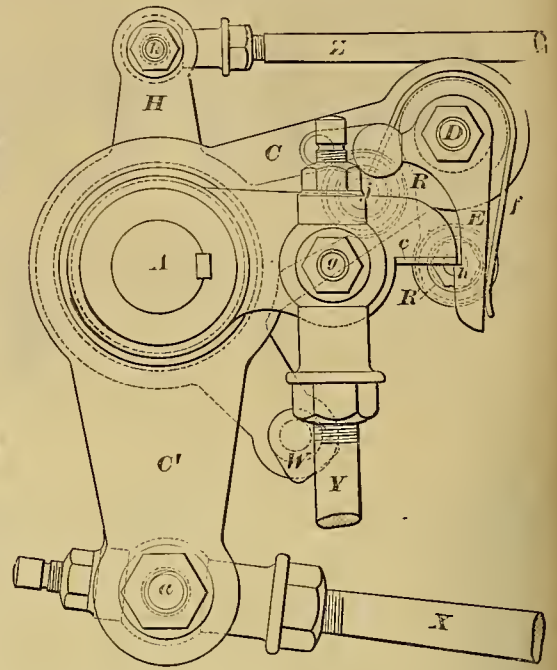

FIG. 3.

These improvements have now been in use a sufficient length of time to demonstrate their value, the governing action of engines so fitted having been found very satisfactory.

**Working of Railroads by Electricity.\***

BY WILLIS E. HALL.

It is asserted that the day is not far distant when we will see railroads, generally known as steam lines, run by electricity from a central station. This is, doubtless, not the first time such an assertion has been made; but I have not as yet seen any discussion of the subject which has more than insinuated the advantages which would result in the operation of railroad lines by such a concentration of power. From a lack of time no attempt is made to analyze the two methods in a mathematical way, but rather it is aimed to point out some of the many advantages which the

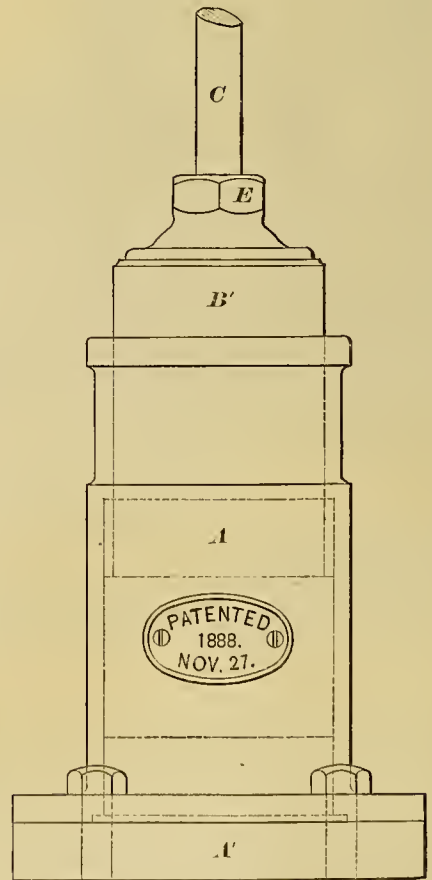
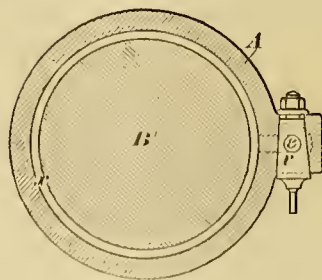
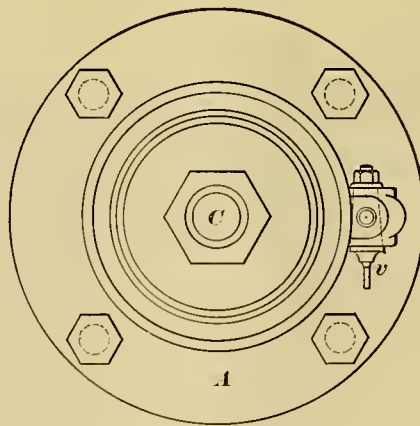
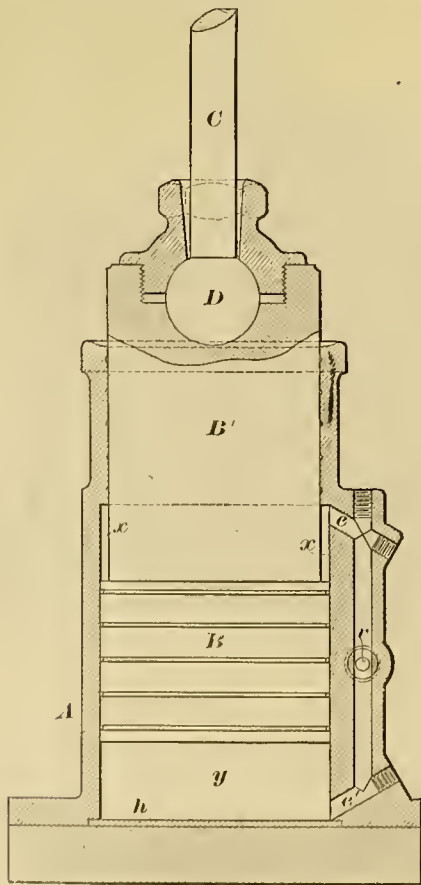

FIG. 5.—VALVE GEAR DETAILS.

ing and until the engine has attained full speed. Fig. 5, gives a view of the improved dash-pot now used on these engines, which is known as Cité's differential vacuum dash-pot. *A* is a cylindrical shell having two bores of different diameters, and fitted with a plunger *B'*, *B*,

cock *v*, acts as a cushion, which arrests the motion of the parts, and does away with all pounding. As the air in this dash-pot is not drawn in from the outside atmosphere during the rise of the plunger, to be again forced out by its descent, but merely passes from one chamber to the

use of electricity allows, and which will inevitably result in operating a long line.

With this object let us take a few of the changes which the substitution of centralized electricity would inaugurate when used in place of the present system of locomotives.

One very important gain would be the concentration of

\* Read at the Cincinnati Meeting of A. S. of M. E.



the power at one point, for a given length of line, into a few cylinders, instead of working it in a number of isolated engines where the insulation is poor and the chances for condensation the best. A number of central stations—located, say, at a distance of 30 to 40 miles apart—could be run by large powerful engines, and the expansion of the steam worked at an economical point by better and more economical means of cut-off than can be obtained in the present type of locomotive construction. With locomotives the ratio of expansion at low speed is correspondingly poor, nor can we expect to make an efficient engine of it, except in one working condition which is dependent upon the concurrence of so many variables that the engine is never worked in that ratio for any length of time. With stationary engines, however, the case is the reverse, as these are designed to work at a constant speed, and if properly proportioned would be utilized at the highest grade of expansion consistent with economy. This point would not vary much, as experience with hydraulic and electric plants would indicate. The fluctuations in the case of a railroad line would probably be even less, as the working is generally uniform throughout the twenty-four hours of the day. It would be a case of a properly loaded automatic cut-off engine against the equivalent of a similar engine vacillating between an over to an under load, and such range of the broadest nature. We must not lose sight of the fact that the question of keeping the line clear is properly held as of higher value in a closely worked system than is the consumption of coal which may result per the horse power, which the engine is to develop to reach its destination as scheduled. In furtherance of reduction in coal consumption, the use of condensing—and possibly compound-

track tanks and water stand-pipes distributed closely throughout the line, which means considerable to those who are acquainted with the attention and repairs (especially through the winter season) which such arrangements demand. The delay, too, where freight engines are not equipped with water scoops, is apparent; and even this latter method of filling tanks is beginning to show its effects upon the schedule, which it is possible to make on lines which are worked closely to their limit. Nor would it be necessary to carry the dead weight of tender which contained water, which is hardly as easy an accompaniment as its name would imply. In this connection it might be well to mention the annoyances from cleaning fires, as is required in freight service where the division is a long one.

The experience with the centralization of power where large hydraulic, electric or pneumatic plants are in operation, is that a greater amount can be supplied than it is necessary to develop at the station—that is, where there is much division (such as would be the case when the power is distributed through commercial districts and divided into small parts) a 50 to 60-horse power plant can take and supply satisfactorily about 200 horse power. In railroad work such a ratio could hardly be looked for, as the number of trains would not be as large as the division where the power is distributed for mercantile and commercial purposes; but a reduction of some 25 per cent. can safely be counted upon. The reason for this is evident, as it never occurs that all the power will be used simultaneously which each division is capable of exerting. With railroads, too, it will not occur that all trains would be exerting their maximum power, such as, for instance, climbing heavy grades at the same time.

In fact, the elimination of such details could be extended almost indefinitely, and in them there would appear visions of a removal of a mass of the little annoyances from the shoulders of those who are now held responsible for the maintenance of this accumulation of complications.

The loss in electric transmission has not been neglected, which in a station controlling a line of, say, 30 miles would, at the present state of the science, amount to some 50 per cent.—which includes loss in dynamo, line, and the loss from an average working of motor. This, together with the cost of necessary plant, as capital, comprise the two main objections against the introduction of electricity for transportation purposes.

No attempt is made to take up the advantages or disadvantages (as shown by mathematical calculation) resulting from such a system, but it is merely desired to mention some of the many practical points which would be met, eliminated or improved upon by the substitution of electricity in general railroad working. Nor is it that its introduction is anticipated within a year or two; but we cannot but acknowledge that the application of electricity is becoming more general, and, from the rapidity of its development, its use for such purposes is hardly more distant than the most sanguine of its advocates would predict.

The combination of electrical with mechanical engineering will bring about as much of a revolution in the future as it has done in the past; but in all its applications we must expect to see it creep before we may see it walk. A more thorough intermingling of the mechanical, however, would hardly be a detriment to much of the so-called electrical engineering.

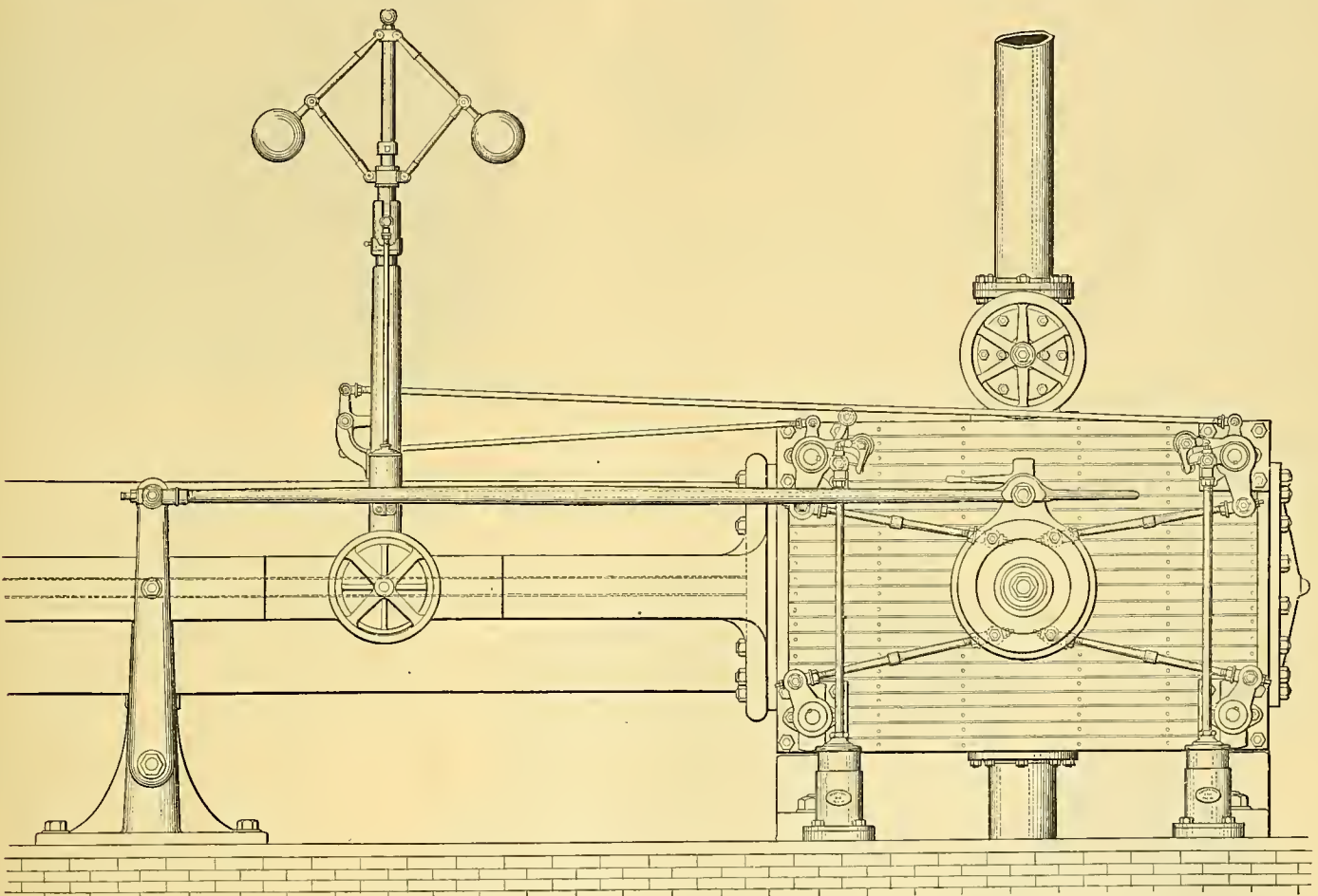

FISHKILL-CORLISS ENGINE—REGULATOR AND VALVE GEAR.

ing—at a central station would raise this part of the working of the line to the highest grade of efficiency.

In experiments recently made it was found that an electric motor could climb a grade of over 50 per cent., which is far beyond the point of adhesion of locomotives; so that in this direction we could look for a marked improvement. An analysis of the conditions in the two cases will disclose the reason for this, and no doubt all who have had any experience with engines which were overloaded or which slipped their drivers easily will appreciate its importance.

The question of attainable speed enters as a factor, for the speed to which an engine can safely be driven is known to have its limits—and which, to all appearances, we are now closely approaching. The piston speed of an engine with 24 in. stroke and 68 in. diameter of driving wheels, traveling at 60 miles per hour, would be about 1,400 ft. per minute. An increase in the diameter of driving wheels, with the object of decreasing the number of strokes, makes the engine correspondingly weaker, so that two sharp horns of a dilemma are placed before him who attempts to design an engine to haul the increasing weight of trains at a high speed. The questions of ports and velocity of steam are mentioned in passing. The resistance of trains is now quite positively known to increase about with the square of the velocity which would enter as a function in the power to be given to a motor to drive a train at a desired speed. With such a means, however, the speed is limited only by the power which is given in its design, and is determined more by what the conditions of the service will stand.

With electric motors it would not be necessary to have

The best kind of mechanical ingenuity and high efficiency of any mechanical design which is made to accomplish a given object are dependent, principally, upon reducing the number of parts which it contains, so long as the desired result is obtained. Multiplication of parts increases the number of pieces to wear and consequent repairs, as well as the chances of failure from breakage. No argument is necessary to indicate the advantage which electric motors would have over the present design, or over any other design of locomotive where all the requisites of an engine must be incorporated in so many isolated places. The failures from leaky flues, broken eccentric strap knocking a hole in the fire-box, blowing or knocking out cylinder heads, and the multitude of accidents which are happening every day on railroad lines, would be decreased to a marked extent. The reduction in the internal friction of the driving mechanism is also apparent.

No comparative mention has been made of the cost of repairs, the too large percentage of power which is idle to have this work done, the reduction in the number of motors required to make the same train mileage (due to more uniform and consequent higher average speed, resulting in a reduction of time to go over a length of line), together with the loss of coal from irregular working of engine and boiler where the line is undulating, as is the case with all to a greater or less extent; also the attention and care which a large number of isolated boilers demand to keep them in safe working condition, as well as the rapid wear of machinery where it is exposed to out-door influences, such as dirt and the elements, as is the case with locomo-

CRITICISM.

After the presentation of Mr. Hall's paper, F. A. Scheffler advanced the following points in criticism of several of the statements which were made:

In reading over the article which has just been presented by Mr. Hall, I am tempted to give a few points in regard to the cost of installing a railroad plant, such as the author of the paper thinks will be required in the near future, and at the same time I desire to state that it is to be regretted that Mr. Hall did not spend some little time, before writing his paper, in looking up the matter of electrical data as far as railroads are concerned, and the necessary cost of installation of the generating stations at a distance of not more than 30 miles apart.

The ordinary locomotive of to day, when running at the average rate of speed and hauling the average load, does work of not less than 300-horse power. Supposing the station to be built to have a capacity to each 30-mile section of not more than one locomotive, the capacity of the generating station would necessarily have to be not less than 360-horse power. As the best forms of motors at present have an efficiency of only about 80 to 85 per cent., it will require, therefore, for the generating station a 360-horse power engine and sufficient boilers for operating same. The cost of the station can be summed up about as follows:

One 360-horse power engine.....	\$10,000
Battery, A 1, of 360-horse power boilers.....	7,000
Station building.....	5,000
Steam connections, pumps, feed-water heaters, etc	2,000



Generating dynamo.....	12,000
Electrical station, appliances, etc.....	1,000

Making a total of.....\$37,000

The foregoing station outfit will not permit of having an auxiliary plant of engine, dynamos and boilers, which ought really to be included in the outfit, so that in case the engine or dynamos or boilers should, at any time, become inoperative, there would be another set of appliances to operate the railroad with. An auxiliary set of appliances would almost double the total cost of the station.

For operating expenses of the station we have the following:

5 per cent. depreciation on engine and boilers ..	-\$ 835
4 " " " " dynamo.....	480
6 " " interest on the station plant.....	2,220
2 firemen, night and day.....	1,440
2 engineers, " " ".....	3,080
Maintenance, such as oil, waste, etc .....	300

Making a total of, not including the cost of coal...\$8,355

In order to ascertain what the cost of coal would be, we will suppose that the total power is required for only one-half the time, and one-quarter the power for the balance. This will give us 2,774 tons of coal per year, required. This assumption is based on the supposition that the engine will require 3 lbs. of coal per horse power hour; if it were a condensing engine, of course the assumed rate of coal per horse power would be too high, but I should not think it would be advisable to use a condensing engine where the power would be so largely variable, and water along railroad lines is not always available for condensing purposes. Basing the cost of coal at \$3 per net ton, the expense per year for same will be \$8,322; adding this to the operating expenses of the plant at the station, we have a total of \$16,677.

So far, we have only taken into consideration the necessary cost of operating expenses of the station plant. We have now to consider the erection of the necessary electrical circuits along the line, the depreciation of same, and interest on the cost of same.

Suppose that the pressure at the terminals was fixed at 2,000 volts, in order to deliver 300-horse power to the motor, it would be necessary to carry 112 amperes on the line, and allowing 20 per cent drop in the pressure, by simple calculation we find that the conductor will have to be of an area equal to a copper rod, 1 inch in diameter. The pressure of 2,000 volts is altogether too high to think of safely using the rails for the return circuit, and a copper conductor would also have to be used for this circuit making two lines of copper conductors, 1 inch in diameter for the outgoing and return circuits. If the circuit is 30 miles long, it would require the enormous quantity of 476,784 lbs. for each conductor; and the cost for copper wire at the present time being 17 cents per lb., the amount required to pay for the copper wire would be \$62,106. The interest on this outlay, at 6 per cent., would be \$9,726.

As an overhead circuit would be the cheapest possible way of conveying the current to the motor, and as the wire is of such an enormous weight, it would not be well to have the poles more than 50 ft. apart. This would require 6,300 poles. Basing the cost of the poles and erecting the same at \$2.50 each, we have the total of \$15,750. Erecting the line would be charged at \$150 per mile, and this is a very low figure. This would give us \$4,500, making a total cost for the line \$20,250. The interest on this, at 6 per cent., would be \$1,215.

Continuing the statement of operating expenses it would be necessary to add the interest just given to same, and also the depreciation of the line. Putting this latter at about 2 per cent. (which is very low), which would be \$3,627, we have a sum total of \$31,245 as the actual an-

with that of the locomotive. We have not the exact figures of the coal consumed by the ordinary locomotive, but I do not think it is any less than 8 lbs. of coal per horse power hour. This being the case, and as the locomotive develops 300 horse power for 12 hours, and one-quarter of this horse power for the balance of the day, we would have, per year, a consumption of 6,570 tons. This, at \$3 per ton, is equivalent to \$18,710. Deducting the same from the total operating expenses of the electric station, we find that the difference is in favor of the steam locomotive to the extent of \$12,475 per year. I do not think there would be any difference in cost of repairs between the electrical and the steam locomotive. The total cost of the station, copper wire, poles and lines, complete, would be \$219,356. This amount of money would buy about twenty new locomotives.

The foregoing estimates are all based on inside figures, and if the railroad were 600 miles long, it can be readily seen what an enormous expenditure for electrical purposes would be necessary, and comparing this with the cost of the present steam railroad would be sufficient to upset any calculation in the line of electrical railroads.

I have selected an average of \$2,000 as a basis for estimating the cost of line, simply because it would require extraordinary care in insulation for a higher potential, where the bare conductors, connections, insulating material, etc., would be subjected to all kinds of rough weather. If it were found that 4,000 volts could be satisfactorily insulated (and this has been done with covered wires in a few special cases), the first cost of line equipment would be very largely reduced to, say, about one-half of the above estimated cost, thereby reducing the yearly expenses of operating by decreasing the interest and depreciation of the plant. As far as safety to human life is concerned, I do not believe that 4,000 volts would annihilate more completely than 2,000; but the chances for leakage of current at the higher tension would be much greater. This would mean greater coal consumption and reduced efficiency of the electrical apparatus. The operation of the plant at the full power for one-half the time involves, of course, the use of several motors, which has not been considered in the matter of operating expenses. Such considerations would not make any difference in cost of operating expenses, because there would necessarily be the same amount of expense in the line of engineers, firemen and depreciation, etc., for the locomotive, as there would be for an equivalent number of motors.

A statement made by Mr. Hall is as follows: "In experiments recently made, it was found that an electrical motor could climb a grade of over 50 per cent., which is far beyond the point of adhesion of locomotives." I would like very much to make an inquiry as to the facts of these statements; it would be very interesting to the members to learn what motor it was, and how long the grade was, and what speed was attained. It is well known, of course, that there is some very peculiar action between the tread of the wheels of electrical street cars and tracks, whereby they can ascend a higher grade than any other kind of motor

work of all kinds, as there is no branch of the world's industry which is or will not be influenced by the electrical industry.

I, too, desire to see electricity supplant the present steam railroad, but at present I cannot see exactly how this can be accomplished from a commercial standpoint.

If as much progress is made in the next ten years as has been achieved in the past decade, there will be more of a possibility of our capitalists adopting electricity in place of steam on railroads.

Three different members have asserted that I have estimated too highly by 50 per cent. in three different items.

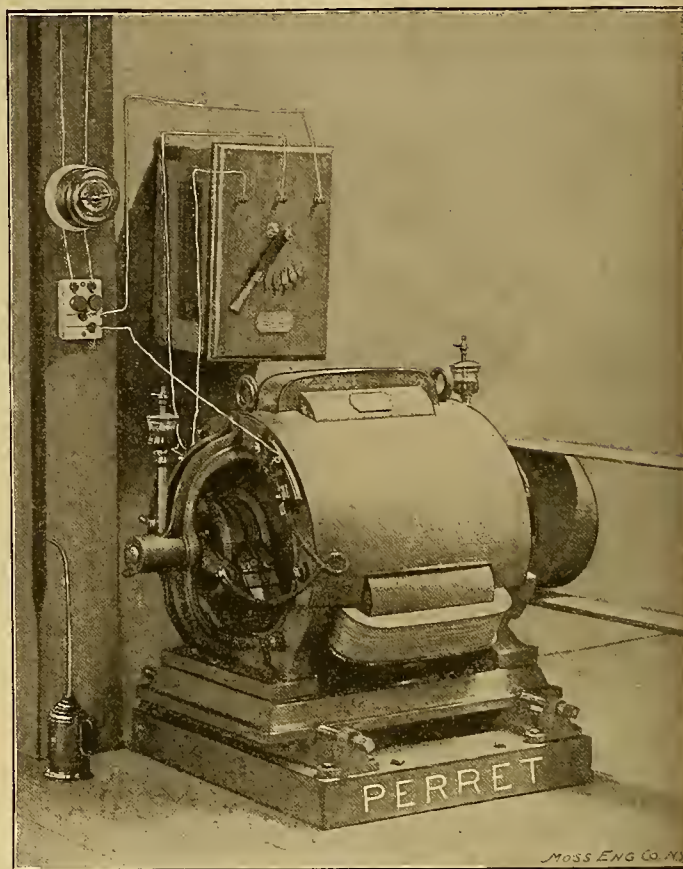

FIG. 1.—LOW-SPEED ELECTRIC MOTOR.

I do not desire that my figures shall be taken as absolutely correct, but I would like to have a comparison of cost by parties who are familiar with electrical and mechanical estimates, from a conscientious point, made upon the same basis which I have estimated. I shall be happy to acknowledge any error which I may have made, and will be only too glad to cut down the apparently enormous first cost of even one section of the suggested railway plant.

A specially devised method of feeders will possibly reduce the cost of the copper circuit, but at present I do not see wherein even this could be accomplished, unless, perhaps, a 3-wire system should be used, but which would involve a further complication of carriers, etc. One thing certain is that to carry 300-horse power at 2,000 volts, with 20 per cent. drop, requires the same amount of copper for conductors, whether the latter be composed of one or is subdivided. I have taken as a basis the lowest possible generating capacity, and an increase of this simply means additional first cost, and some of our heavy locomotives surely develop a much higher amount of power at certain times than 300 horse power. I have also estimated upon only one motor being in operation on the 30-mile section, whereas it would not be a very paying road which would operate under such a condition. More than one motor upon the section at the same time involves a still further increase of generating plant and conductors. I have only presented these latter considerations to show that I do not think my estimates too high.

**Perret Low-Speed Electric Motors.\***

The accompanying cuts illustrate the automatic low-speed electric motor, of the multipolar type—a form which the makers have adopted for all sizes above 2-horse power. The low speed motor is designed to run at from 500 to 600 revolutions per minute. For special work the armature can be wound for a speed of 350 revolutions. It is stated that while the speed is comparatively low, the machine is not heavy as is the case of many motors designed for slow speed for special work.

The practical advantages of low-speed machines are many. In ordinary machine shops, wood-working shops and printing offices, for ex-

\* Elektron Mfg. Co., Brooklyn, N. Y.

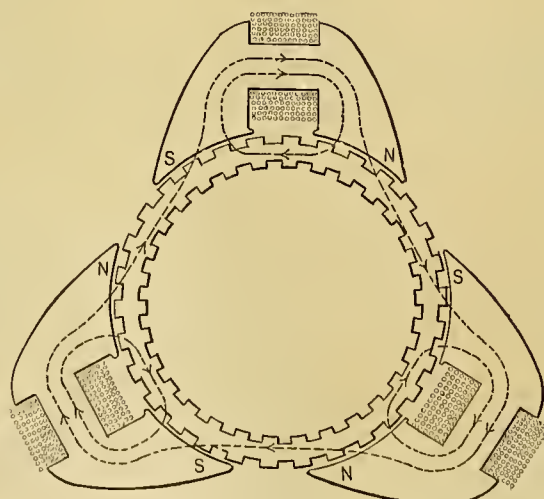
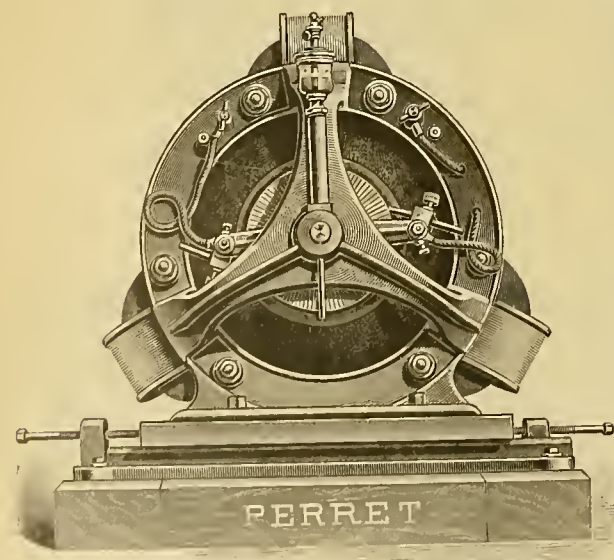

FIGS. 2 AND 3.—LOW-SPEED ELECTRIC MOTOR.

nual cost of operating expenses of the station plant, and interest, depreciation, etc., on each section of 30 miles.

It will not be necessary to take into consideration the cost of operating the motor, as this would be about the same as the cost of operating the steam locomotive; and the cost of same would be about the cost of a first class locomotive. The only comparison which should be made between the operating expenses of the steam locomotive and the electrical, would be that of the difference in coal consumed between the station and the steam locomotive, and possibly the cost of repairs of the motor, compared

power, except the cable system; but I am very loth to believe that an electric motor can ascend a grade of over 50 per cent.

It is safe to say, that unless there are some radical changes made from the ordinary design of electric generators, and in the method of the transmission of the current to the motor, as well as a motor of greater efficiency, that we will never see electric railroads operated in this, or any other country.

I am particularly desirous of furthering any matter which pertains to the advancement and introduction of electrical



ample, the shafting is commonly run at from 200 to 300 revolutions per minute, and it is a simple matter to belt directly to it from a motor running at 500 or 600 revolutions. The counter-shaft and one belt are dispensed with, and considerable power is, therefore, saved. The same thing applies in the case of an elevator operated by a belt. In fact, in elevator work, it is possible to gear directly from the motor. The Perret machines have recently been applied by direct gearing to pumps and to coal cutting machines in mines and also to the operation of coal cutting machines by means of rope transmission from the motor to the cutter. The motors are peculiarly adapted to the direct driving of large exhaust fans and blowers, and to operating hoists and traveling cranes. In addition to the advantages of low speed in the special cases mentioned, there is, of course, in all cases, a general advantage in the avoidance of the rapid wear and deterioration often connected with high speed.

The Perret machines are built with a 6 pole field and with armatures of large diameter. A powerful torque and great momentum of armature are secured, which are decided advantages when a heavy load is thrown suddenly on, as is often the case in elevator work and all sorts of hoisting.

Mr. Perret has been able to retain in these larger machines the distinctive feature of laminated field magnets which were characteristic of his smaller machines. He states that the results secured would be practically impossible with any other construction.

Fig. 1 is a side view of a 20-horse power motor complete, with sliding base and starting box. Fig. 2 is an end view of the same machine, and Fig. 3 is a diagram showing a cross section of the magnetic circuit.

It will be seen that the armature is a ring of comparatively large diameter, with longitudinal channels on its periphery, in which the conductors are wound. They are thus embedded in the iron, which is in such close proximity to the iron pole pieces that there is practically no gap in the magnetic circuit.

The field consists of three separate magnets, arranged at equal distances around the armature, each magnet having two pole pieces. The winding is such as to produce alternate north and south poles. The magnets are built up of plates of soft charcoal iron, which are shaped as shown in the diagram, and the magnet thus produced is of such form that it may be readily wound in a lathe. A non-magnetic bolt passes through a hole in each pole piece, and the plates are clamped together between washers and nuts. The bolts also serve to attach the magnets to the two iron end frames which are of ring shape, and are bolted to the bed plates of the machine.

The magnetic circuit is of unusually low resistance by reason of its shape, its shortness, which is shown by the diagram, and the superior quality of iron used.

There is, it is claimed, no loss of magnetism in the frame or in the shaft of the machine, as the magnets are supported at some distance from the former by means of the non-magnetic bolts, and the armature is mounted on the shaft by spiders of non-magnetic metal. The whole machine is enclosed also by a shield or case of sheet metal, as shown in Fig. 1.

The machines are calculated to be equally as efficient dynamos, and are coming into use in many small isolated incandescent light plants. For this purpose they are compound wound, and the regulation, it is claimed, is so perfect that all but one lamp may be suddenly turned off without moving rheostat or brushes, and without noticeable change in the brilliancy of the remaining lamp.

Their low speed makes them well suited for direct connection to steam or gas engines, and they are suitable for lighting railway trains, yachts, steamboats, etc., as also for any purpose where a low speed machine can be used.

**Sperry System of Electric Lighting.**

In the new Sperry dynamo we find some of the features contained in the earlier machines, which have stood the test of time, the increased knowledge of electricity and magnetism having failed to suggest any better design or point out any fault in the principles or construction. The first Sperry dynamos and lamps were brought out

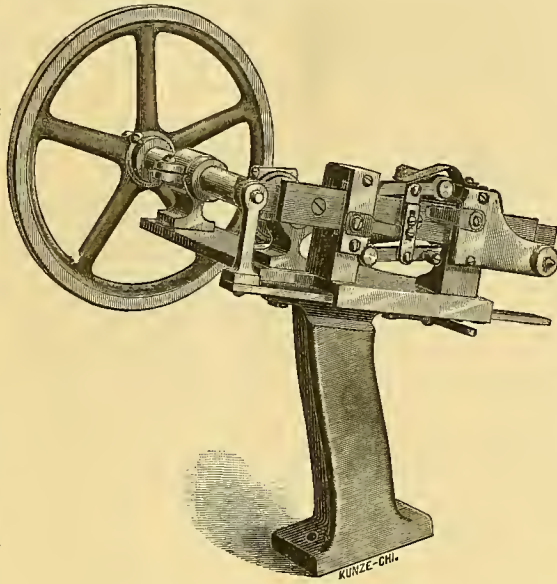

REGULATOR—SPERRY SYSTEM.

several years ago and during that time have proved themselves the equal of other systems. The characteristic feature of the dynamo is the internal pole-piece by means of which a much larger percentage of the armature wire is brought directly under the influence of the inductive effect of the pole-pieces. The armature is of the Gramme type, being a ring of large diameter, which feature permits a high peripheral velocity, causing the armature wires to cut

is the regulating apparatus by which a constant current on the circuit it maintained regardless of changes in the resistance or the work on the line. Among the various designs of apparatus for the purpose of regulation there has been no method produced that gives any better results than changing the position of the brushes on the commutator. The simple and efficient device by which this is accomplished requires but a minimum of the current to operate it, the greater part of the power required, which is very little at the most, is derived from the motion of the armature shaft. The apparatus consists of a bar having teeth cut on each side along a portion of its length and working in a guide, one end projecting and connecting to the rocker which carries the brush holders. Two pawls are provided, which, pointing in opposite directions are kept in reciprocating motion by being connected with a crank on the end of the spindle carrying the grooved wheel, which derives its motion from the armature shaft, as shown in the cut. Near the field magnet, on the opposite side of the machine, is a pivoted armature kept in balance while the current on the line is at the required amount, and in this position preventing either of the pawls from engaging with the rack. Should the current change, the armature would be moved sufficient to cause one of the pawls to engage with the rack, and the reciprocating motion imparted to them would feed the bar along carrying the brushes to the position required to again bring the current to its normal amount. The peculiar construction of the feeding apparatus by which the step by step motion is obtained is so arranged that with a slight change in the current a slight, but instantaneous, movement will be imparted to the brushes, while if a greater change in the strength of the current should occur, such as is frequently the case when supplying current to motors, the apparatus would instantly cause the brushes to move over a much greater angle in the shortest space of time. The change in the intensity of current and the change in the position of the brushes are practically simultaneous.

The Sperry arc lamps possess some peculiar features, not found in other lamps, by which the arc is maintained at a point that renders it quiet and steady, the differential feature of other lamps not being used. The system, as a whole, is complete in itself and is especially applicable to central station and isolated plants.

**Gearing With Wooden Teeth For Electric Railways.\***

Perhaps the most important point in the application of electrical power to street car propulsion is the problem of transmitting the power from the armature shaft to the car axle. In the earlier experiments, both abroad and in this country, belts of leather and rope were used, and also the sprocket wheel and chain. These methods were abandoned and some system of gearing is now almost universally adopted. Owing to the high speed of the armature, it is customary to use a small pinion, and at least one counter-shaft between the armature and the large gear on the axle, in order to get the desired reduction in the number of revolutions of the car wheel. If the car wheel and axle are making 115 revolutions per minute, the intermediate 345, and the armature pinion 1380, the ratio would be

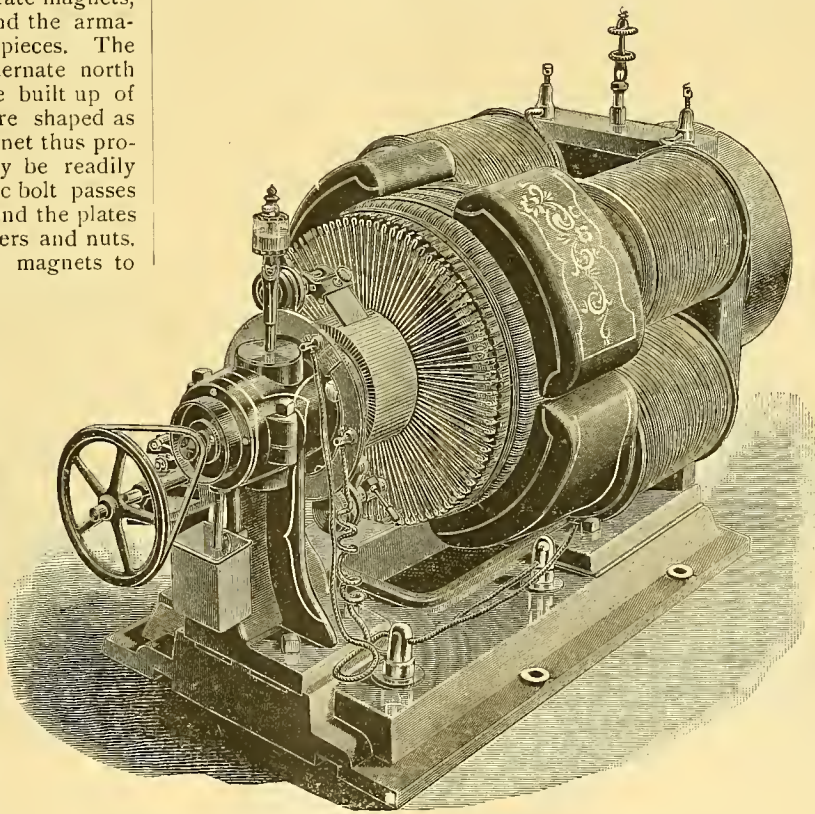

DYNAMO—SPERRY SYSTEM.

the lines of magnetic force at great speed while the shaft has a very low rate of revolution. The Gramme ring, which was among the earlier designs, still retains its place among armatures of high efficiency, and by many is declared to be the best form. The field magnet coils are connected in series thus obtaining best results with much less resistance than by the use of shunt fields and giving the greatest facilities for the regulation of the current.

The most interesting feature about the dynamo

12 to 1. The axle gear containing fifty teeth would make 115x50 or 5750 meshes of teeth per minute for axle gear and intermediate pinion. The small diameter of pinion will not allow more than seventeen teeth, which are usually less than four inch face. In ordinary mill practice this pinion would be considered entirely too small to transmit 10-horse power or even 5-horse power for any considerable length of time running at more than 800

\* Chadbourne, Hazleton & Co. Phila. Pa.



revolutions. When it is placed under a motor car the revolutions exceed 1000 per minute, transmitting from 15 to 20-horse power. At the same time mud and sand must be contended with.

With this form of gear certain difficulties were encountered. The gear caused too much noise and its teeth were liable to break. To overcome these defects the interchangeable gear illustrated in the cuts was designed.

The old form of gear, when new, seems to give good satisfaction with pinions made of either cast iron or steel. After the car has been used a few weeks, however, so much wear comes upon the pinions, which have to do about four times the work of the gears, that they become badly worn and very noisy. Furthermore, there is considerably twisting of the motor in stopping and starting which tends to throw the shaft out of alignment, and results in wedging the teeth apart and breaking or nipping them out.

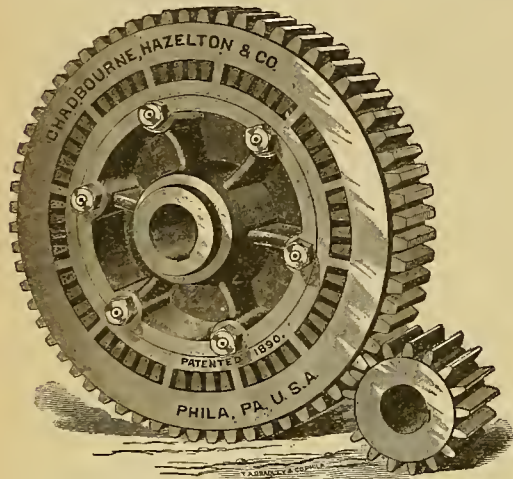

FIG. 1.—ELECTRIC RAILWAY GEARING—INTERMEDIATE GEAR AND PINION—WOODEN TEETH.

An effort was made to overcome the noise of the metal pinion running on a metal gear, by substituting some soft material for the pinion. Raw hide, vulcanized fiber, and combinations of rawhide and metal have been tried.

Since the pinion must necessarily do several times as much work as the gear on which it runs, the result is the former wears out so rapidly, that the expense has made it difficult for the management of roads to keep rawhide or soft pinions on motors. The result would have been different if the softer cog had been put in the wheel having the greatest number of teeth. If seventeen soft teeth in the armature pinion would last three months, transmitting a given power, it is not unreasonable to assume that thirty-four soft teeth in the intermediate gear, transmitting the same amount of power would last twelve months under similar conditions, therefore the intermediate gear and split gear on the axle

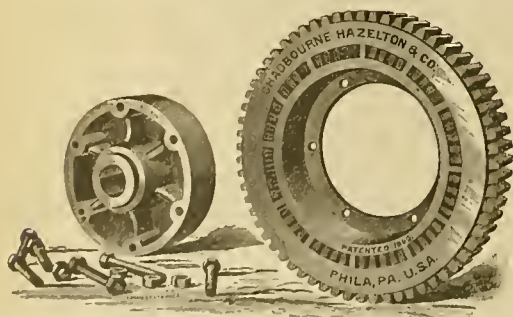

FIG. 2.—ELECTRIC RAILWAY GEARING—INTERMEDIATE GEAR, RIM REMOVED—WOODEN TEETH.

should have cogs of some softer material than the pinions, it is claimed.

The intermediate gear shown in Figs 1 and 2 consists of three parts: the blank or hub which is keyed fast to the axle, and the removable rim which holds the cogs, and which is bolted to the hub, and the wooden teeth which are inserted in the rim.

At first thought it may seem that the wooden teeth would hardly stand the strain and wear and tear which is brought upon them in the street car service. In New England where the largest mills are driven by turbine wheels, and where thousands of horse power are used in a

single mill, the entire energy is transmitted through bevel gearing, the larger gear always having wooden cogs. These are used because nothing else has yet been found that will stand the work. The cogs last several years, and are renewed at a slight expense, being simply driven in the iron frame of the wheel, and they have the advantage of being elastic and noiseless.

The teeth which are used in the gear shown in the cuts are driven in with white lead, and wedged at the base in the usual way. They are then put into the gear cutter and shaped in the ordinary manner. The rim, which is made of

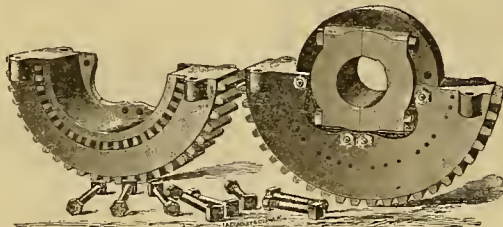

FIG. 3.—ELECTRIC RAILWAY GEARING—SPLIT AXLE GEAR—SECTION OF COGGED RIM REMOVED—WOODEN TEETH.

cast iron, slips over the blank, being held in place by six bolts. Between the rim and the hub is laid a sheet of oil paper, which prevents corrosion and tends to stop vibration or "bell tone" from the gear.

The blank is keyed firmly to the intermediate shaft and need never be removed; after the wooden teeth have become entirely worn out, all that is necessary is to remove the six bolts and slide off the rim, Fig. 2. An extra rim with the teeth in it can then be put on, the entire change not occupying over ten or fifteen minutes. An ordinary carpenter or wheelwright, it is asserted, can recog the old rim and cut the teeth in a half day's time.

The armature pinion for running in this gear and the pinion on the intermediate gear, are made of forged steel with the teeth case-hardened, after being cut.

The split axle gear, Figs. 3 and 4, has a rim similar to the intermediate gear, into which are driven wooden teeth. The split gear is composed of two parts, the blank or hub which is split and put on to the axle, and the rim which is also split and put on so as break joints with the hub.

Figs. 5 and 6 show split gear for the axle in which the toothed rim of phosphor bronze, is removable.

Interior Conduits.\*

In the work of developing the comparatively new but already extensive electrical industry, first importance has been given to economical considerations. The generating machines have attained a degree of efficiency which places them in the very front rank of economical apparatus. The art of distribution has become so familiar as to be recognized as one of the exact sciences. The details of regulation, measurement and convenient location of wires, switches, lamps, etc., have all received extraordinary attention and attained a high degree of excellence. In consequence of the progress thus made the public is to-day enabled to secure electric light at approximately the price of gas. It can obtain electrical power at a cost which, in many cases, is less than that of steam or other motive power. The successful application of electricity to street railway propulsion has been so phenomenal as to attract



FIG. 4.—ELECTRIC RAILWAY GEARING—CONSTRUCTION OF SPLIT GEAR—WOODEN TEETH.

the attention of the industrial world, and the application to mining machinery, now being inaugurated, promises even quicker and more uni-

\* Interior Conduit & Insulation Co., 16 and 18 Broad st., N. Y.

versal acceptance. It will be readily surmised that in distributing the hundreds of thousands of horse power of electric energy requisite to perform all this work, the aggregate mileage of interior conducting wires employed must assume enormous proportions, and that in consequence the superficial area of inflammable property traversed by them must represent a risk area so great as to justify the expectation of daily recorded fires of more or less magnitude. That this anticipation is, as a matter of fact, not realized, and that electricity really originates so few destructive fires, is, in view of the newness of the industry and the necessarily imperfect training of the labor at command, but evidence that electricity possesses an extraordinary high factor of safety, far higher in fact than any other force with which we are familiar. To appreciate this, we have only to imagine the results that would follow an equally

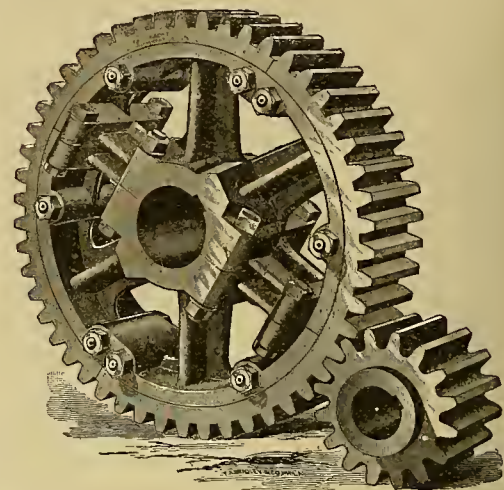

FIG. 5.—ELECTRIC RAILWAY GEARING—SPLIT GEAR AND PINION—PHOSPHOR BRONZE TEETH.

sudden and vast expansion of the industry of steam or gas distribution at a like initial stage and with a like paucity of skilled labor. The property possessed by electricity, which thus undoubtedly minimizes the chances of serious results, is its celerity of action. Time is a requisite to ignition in the case of a great majority of inflammable materials; electrical action resulting from derangement is generally so instantaneous as to practically eliminate time, hence ignition becomes the exception rather than the rule. Were it otherwise, the record of disastrous fires would be much augmented. Nevertheless, there are conditions of derangement under which the electrical action will afford this element of time, which may in fact permit of a prolonged presence of the consequent heat; when these conditions prevail, serious consequences generally ensue, to which fact is due that suspicion and prejudice which is the sole barrier to the general adoption of electricity for all purposes to which

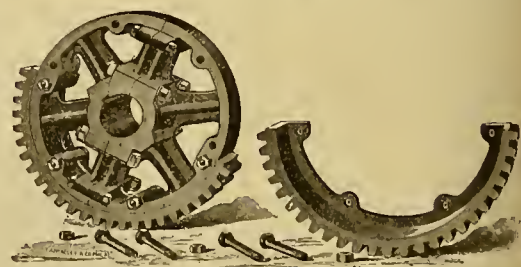

FIG. 6.—ELECTRIC RAILWAY GEARING—SPLIT GEAR—RIM REMOVED—PHOSPHOR BRONZE TEETH.

it is applicable. If all electrical action were made instantaneous and the comparatively innocent effects of such action were localized where they could be safeguarded, this prejudice would at once disappear, and the industrial world would recognize their command of an absolutely safe force equal to their every requirement.

In wiring for constant potential systems, it has been demonstrated by experience that the work can be most economically and effectively executed when centers of distribution are established from which all minor branch circuits radiate. This system of the Interior Conduit & Insulation company of New York has been modeled entirely upon this plan. For mains and feeders the company employs a separate tube for each



conductor, in which a rigid wire, with either underwriter's or weatherproof insulation, is used. For branches the special flexible twin conductor, with both conductors in one tube, is always used. It is easily seen from Fig. 1, that by employing as many risers as possible long lateral runs, which are objectionable, are avoided. Fig. 2 shows the crib used in this system of distribution.

Prior to the inauguration of what may be termed the new electric era, electricity was used almost solely for the purpose of transmitting intelligence; the telegraph, the telephone, the fire-alarm, the various signaling systems and kindred applications are examples of such use. In these industries the insulation of the wires has but one function, viz.: that of maintaining an effective



FIG. 2.—INTERIOR CONDUITS.

service. If the insulation fails, the service fails; no other untoward result follows, for the reason that the currents employed are so weak as to be incapable of developing any considerable degree of heat. With the inauguration of the new era, involving new applications, as, for example, electric lighting, electric motive power, and kindred uses, employing electricity under high pressure and in vast quantity, there was imposed upon insulation an additional duty, viz.: that of protecting life and property. If herein the insulation fails, not only does the service fail, but life and property are at once seriously jeopardized. That this risk is not an imaginary one is abundantly attested by the numerous recorded accidents which have occurred during the past two or three years. That the remedy for these occurrences is not to be found in an improvement in the quality of insulation, is equally well attested by the fact that, in spite of all the manifold so-called "perfected insulations," accidents continue to occur. As a matter of fact, the one branch of electrical science which has not ad-

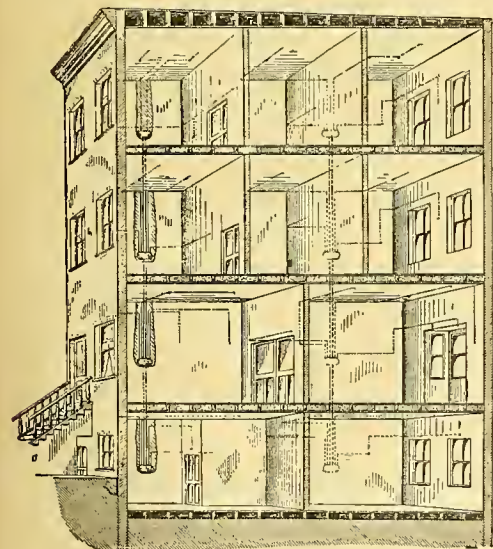

FIG. 1.—INTERIOR CONDUITS.

vanced in line with the new demands is this safeguarding of property from contact with the always-possible abnormal heat development in the wires. It has been assumed by some that inasmuch as electricity was inherently safer than other mediums of lighting, the element of danger was practically absent, and by others that the danger could be sufficiently avoided by improvement in the quality of the insulation, hence the evolution of a host of "improved insulations," many of which doubtless possess great virtue; but unfortunately they all follow one principle, viz.: that of affixing the insulation to, or drawing it upon the wire itself. This is an error. The logic

of all the relating facts in the art is against such practice. Modern electrical service is nothing more or less than a service for the distribution of heat. True, economical considerations demand, and physical laws permit, that the conductors conveying this heat shall be so arranged and so proportioned as to remain cool, and therefore safe while doing the calculated duty demanded of them. But the proportions and conditions thus pre-arranged and determined to secure safety are peculiarly liable to accidental derangement, thus imposing a duty for which they were not calculated; in this event the conditions of safety are gone, and heat is at once developed in such proportion and in such place as the extent and the nature of the derangement may determine. It is apparent, therefore, that any system of insulation which aims to secure absolute protection must take cognizance of, and provide against, the effect of this always possible development of heat. Experience has demonstrated that the practice of affixing the insulation to the wires does not do this. All insulations which can be so affixed are of necessity compounded of oils, gums, or other flexible and adhesive materials, all of which are readily affected by heat. Vain efforts have been made to find a new elementary material, or to compound known materials which shall have the multifold property of high insulation, great resistance to heat, extreme flexibility and proof against acids, gas, etc. The great value to the art of an insulation possessing these naturally diverse qualities has been of late years so keenly appreciated as to concentrate the inventive mind on the line of its pursuit to the exclusion of any consideration of other methods of protecting the wires. This is the only explanation of the failure of the inventors to evolve a natural and effective solution of the problem. Necessity has been well said to be "The Mother of Invention," and it was by virtue of such necessity the total abandonment of the old practice, and the substitution thereof of an enclosing tube, separate from, but forming a channel for conducting wires, continuous throughout their every ramification, was decided upon, thus fully protecting every inch of wire and rendering it accessible for periodic inspection or renewal, and by the same means absolutely confining within the safe limits of a non-inflammable channel the possible heat development.

The practical efficiency of such a method scarcely needs to be supported by argument or demonstration. Its very simplicity appeals at once and alike to the intelligence of the expert and the layman.

**Electric Railway Census.**

The following list of questions have been propounded by the Census Bureau, with a view of ascertaining, as nearly as possible, the exact status of the electric railway industry in the United States. The returns will, undoubtedly, be of deep interest to all to whom electricity as a motive power is a matter of consideration:

**A.—NAME OF COMPANY, ETC.**

1. Give corporate name of the company making this return.
2. Give date of corporate charter.
3. Give date of commencing to operate by electricity.
4. Give number of stockholders.

**B.—DESCRIPTION OF ROAD AND EQUIPMENT.**

1. Was this road originally operated by electricity, or has electricity been substituted for some other motive power?
2. Is any other motive power now used; and if so, what?
3. Give the total length of street over which electric cars are run.
4. Give the total length of all tracks, including sidings, etc., upon which electric cars are run.
5. Describe the electric system in use, stating whether overhead, underground, or storage, single or double trolley, etc.
6. Give weights per yard of rail used and number of miles of track laid with each.
7. What is the maximum grade?
8. How long is it?
9. What is the minimum radius of curves?
10. Give gauge of track.
11. Give number of power stations.
12. Give number of engines used to generate power.
13. State whether engines are single or compound, condensing or non-condensing, and give the cylinder dimensions of each.
14. Give total indicated horse-power of engines.
15. Give average indicated horse-power actually used.
16. Give number of dynamos
17. Give total number of motor cars.

18. Give total number of tow cars.
19. Give average number of cars operated at once.
20. Enumerate other items of equipment.

**C.—OFFICERS AND EMPLOYEES.**

Class—Number—Total Wages or Salary Paid During the Year—  
 Officers and office employes.  
 Motormen.  
 Conductors.  
 Engineers and firemen.  
 Mechanics and electricians.  
 Others employed in power stations.  
 Switchmen, trackmen and others employed on the line.  
 Total.

**D.—PASSENGERS CARRIED, CAR MILEAGE, ETC.**

1. Give the number of passengers carried during the year.
2. Describe other traffic, if any, and state the amount of it.
3. What is the average sum received per passenger carried?
4. Give the number of miles run by electric-motor cars.
5. Give the number of miles run by tow cars.
6. Give the average speed of cars, including stops.
  - (a) In crowded portions of the city.
  - (b) In suburban districts.
7. Give the greatest speed.
  - (a) In crowded portions of the city.
  - (b) In suburban districts.

**E.—CAPITAL STOCK AND FUNDED DEBT.**

**CAPITAL STOCK.**  
 Kinds of stock.  
 Total issued and outstanding.  
 Dividends for the year—rate; amount—declared; paid.  
 Total.  
**FUNDED DEBT.**  
 Kind of obligation.  
 Total issued and outstanding.  
 Interest for the year—rate; amount—accrued; paid.  
 Total.

**F.—COST OF ROAD AND EQUIPMENT.**

**ITEMS OF COST—COST DURING THE YEAR—TOTAL COST TO DATE.**  
 Construction and Real Estate—  
 Cost of roadbed and track.  
 Electrical street construction (posts, wire, etc.)  
 Right of way.  
 Power plant and buildings.  
 Real estate.  
 Total cost of construction and real estate.  
**Equipment—**  
 Passenger cars.  
 Other rolling stock.  
 Motors, trolleys and fittings.  
 Total cost of equipment.  
 Grand total cost of road and equipment.  
 Give the total cost of street construction per mile of single track.

**G.—EARNINGS AND EXPENDITURES PERTAINING TO OPERATION.**

**EARNINGS FROM OPERATION.**  
 Sources of Earnings—Amount Earned During the Year—  
 From passengers.  
 From advertising.  
 From other sources.  
 Total.

**EXPENSES OF OPERATION.**  
 For What Expended—Amount Expended During the Year—

**Maintenance of Track and Buildings—**  
 Repairs of roadbed and track  
 Repairs of buildings.  
**Maintenance of Power Plant—**  
 Repairs and renewals on engines.  
 Repairs and renewals on dynamos.  
 Repairs and renewals on other machinery.  
**Current Expenses for Power—**  
 Fuel.  
 Wages of engineers and firemen.  
 Wages of dynamo engineers and mechanics.  
 Miscellaneous supplies for power houses.  
**Maintenance of Street System—**  
 Repairs and renewals on electric street system.  
**Maintenance of Rolling Stock—**  
 Repairs of cars.  
 Repairs and renewals on motors (except gearing).  
 Repairs and renewals of gearing and trolleys.  
**Current Expenses for Transportation—**  
 Wages of motormen and conductors.  
 Wages of trackmen and others employed on the line.  
 Removal of snow and ice.  
 Damages to persons and property.  
**General Expenses—**  
 Salaries of general officers and clerks.  
 Miscellaneous expenses of general office.  
 Advertising and printing.  
 Legal expenses.  
 Insurance.  
 Total.

**H.—TAXES, LICENSES AND OTHER MUNICIPAL CHARGES.**

For What Paid—Amount Paid During the Year—  
 General taxes paid.  
 Specific taxes (on earnings, dividends, etc.) paid.  
 Paid for car licenses.  
 Paid for other licenses.  
 Paid for tolls over bridges and viaducts.  
 Paid for constructing and maintaining pavements not used by street railroad company.  
 Total.  
 I. State briefly the manner of assessing street railway property for purposes of general taxation.



2. Describe any specific taxation, stating on what based, rate, etc.
3. Give substance of any laws or general ordinances relating to car and other licenses, tolls, maintenance of bridges and pavements, etc.
4. Is the municipal franchise limited in time; if so, for how long a time is it granted?

#### I.—NET INCOME, DIVIDENDS, ETC.

Operating earnings (see "G").  
 Operating expenses (see "G").  
 Net earnings (by subtracting).  
 Rentals received and miscellaneous income (not from operation).  
 Total income (by adding rentals, etc. to net earnings).  
 Fixed Charges—  
 Rentals paid.  
 Taxes paid.  
 Interest paid.  
 Total fixed charges.  
 Net income or deficit (by subtracting fixed charges from total income).  
 Payments from Net Income—  
 Dividends, per cent.  
 Other payments.  
 Total.  
 Surplus or deficit for the year (by subtracting).

#### J.—BALANCE SHEET.

##### ASSETS.

Kind—Amount—  
 Cost of construction and real estate.  
 Cost of equipment.  
 Other permanent investments.  
 Cash on hand.  
 Bills receivable.  
 Supplies.  
 Sundries.  
 Profit and loss.

##### LIABILITIES.

Kind—Amount—  
 Capital stock.  
 Funded debt.  
 Bills payable.  
 Interest due.  
 Dividends due.  
 Sundries.  
 Profit and loss.

#### K.—DETAILS OF ELECTRICAL EQUIPMENT.

##### ELECTRICAL STATION APPARATUS—DYNAMOS IN USE.

1. Type of dynamo designated by character of current generated:  
 Character of Current—Number of Dynamos—  
 Continuous current, constant voltage, variable ampereage.  
 Continuous current, variable voltage, constant ampereage.  
 Alternating current, constant voltage, variable ampereage.  
 Alternating current, variable voltage, constant ampereage.
2. Type of dynamos designated by character of winding and commutator segments:  
 Number of dynamos of each type:  
 Manner of connecting coils electrically.  
 How excited.  
 Number of commutator segments.
3. Capacity of dynamos in use (describe winding, as series, shunt, compound or special):  
 How wound.  
 Number of dynamos.  
 Capacity of each in volts.  
 Capacity of each in amperes.  
 Capacity of each in watts.
4. Capacity of motors in use (describe winding, as series, shunt, compound or special):  
 How wound.  
 Number of dynamos.  
 Capacity of each in volts.  
 Capacity of each in amperes.  
 Capacity of each in watts.
5. Currents generated by dynamos operated in series or multiple:  
 Number of dynamos connected.  
 Winding of dynamos connected.  
 How connected electrically.  
 Character of current generated (see No. 1).  
 Capacity of current generated—volts; amperes; watts.  
 Are dynamos so connected and operated regularly, or in case of emergency only?  
 Give greatest capacity of current ever generated for practical use—volts; amperes; watts.

##### SCIENTIFIC ELECTRICAL INSTRUMENTS USED IN STATION.

6. Give below a list showing number and character of all instruments and apparatus in use in the station, except dynamos.
7. Type of motors and current required (as shunt, series, compound, multiple-series, series-multiple, multiple or specially wound):  
 Type of motor.  
 Number of each type.  
 Horse-power of each type.  
 Highest voltage required.  
 Highest ampereage required.  
 Lowest voltage required.  
 Lowest ampereage required.
8. Character of line:  
 Single aerial trolley, length of line.  
 Double aerial trolley, length of line.  
 Conduit, length of line.  
 Third-rail conductor, length of line.

Series system, length of line.  
 Three-wire system, length of line.  
 Accumulator system, length of line.  
 Character of conductor (as feeder lines, main lines, ground return or mail return).  
 Number of conductor.  
 Total length of conductor.  
 Gauge in mils.  
 Current carried at station.  
 Current carried at farthest terminal.

9. Car equipment and movement:  
 Number of cars carrying one motor; horse-power of motor.  
 Number of cars carrying two motors; horse-power of motors.  
 Number of electric snow-plows; horse power required for each.  
 Give full description of manner of installing motors in cars, snow plows, electrical connections and all devices for electrical and mechanical control.
10. Electric output of station:  
 Volts—Amperes—Watts—Hours of Day—  
 Maximum load.  
 Minimum load.  
 Average load.  
 Load Per Car—  
 Maximum.  
 Minimum.  
 Average.
11. System of lighting cars:  
 Describe in full detail, giving the number of lamps per car, voltage and ampereage required per lamp, and system of wiring lamps.
12. System of lighting power stations and car stables:  
 Describe in full detail, giving number of lamps, voltage and ampereage required per lamp, and system of wiring lamps.
13. Electric lighting other than for cars, power stations and car stables:  
 If lighting is done for the street traversed by the cars as a part consideration for franchise or other privileges or if lighting is done for commercial or residence purposes, or in any way other than for the use of the company, please give full description of the same and state the amount of annual income derived from such sources.
14. Primary current system of wiring motors (as series, series-multiple, multiple-series, multiple, tree wire system double-pressure three-wire system or other systems):  
 System of wiring.  
 Voltage required by motor.  
 Ampereage required by motor.  
 Total number of motors wired.  
 Total horse-power of motors wired.

15. Secondary current system of wiring motors (as series, series multiple, multiple series, multiple, three wire system, double-pressure three-wire system or other systems):  
 System of wiring.  
 Voltage required by motor.  
 Ampereage required by motor.  
 Total number of motors wired.  
 Total horse-power of motors wired.
16. Line construction;  
 Character of insulation  
 Give length of time that each insulation has been used.  
 Average number of poles per mile.  
 Character of material used.  
 Character of soil.  
 Average life of poles.  
 Total length of conductors on poles.  
 Describe system of guy wires, supports, insulators and guards for keeping current conductors in place and tension.  
 Describe devices for protecting persons or property from injury in case of a break in a current conductor or of a wire falling across the conductor.  
 State the total cost of all aerial conductors.  
 State the annual cost of maintenance for all aerial conductors.  
 State number of stoppages that have been occasioned by faults occurring on aerial conductors, and describe cause.  
 State number of breakages that have occurred on lines, and the cause of the same.  
 State number of times wires have been cut by local authorities to remove obstructions to firemen's work or for other causes, giving reasons in full.

17. Aerial and rail return current conductors (describe currents as continuous current, constant voltage, variable ampereage; continuous current, variable voltage, constant ampereage; alternating current, constant voltage, variable ampereage, or alternating current, variable voltage, constant ampereage).  
 Character of current.  
 Number of conductors leading out of station.  
 Size of conductors in circular mils.  
 Current carried—highest voltage; highest ampereage.
18. Part aerial and part ground return current conductors (describe currents as continuous current, constant voltage current, variable ampereage; continuous current, variable voltage, constant ampereage; alternating constant voltage, variable ampereage, or alternating current, variable voltage, constant ampereage).  
 Character of current.  
 Number of conductors leading out of station.  
 Size of conductors in circular mils.  
 Current carried—highest voltage; highest ampereage.

##### LINE CONSTRUCTION.

19. Aerial current conductors (describe currents as continuous current, constant voltage, variable ampereage;

continuous current, variable voltage, constant ampereage; alternating current, constant voltage, variable ampereage. or alternating current, variable voltage, constant ampereage).

##### Character of current.

Number of conductors leading out of station.

Size of conductors in circular mils.

Current carried—highest voltage; highest ampereage.

20. Underground current conductors (describe currents as continuous current, constant voltage, variable ampereage; continuous current, variable voltage, constant ampereage; alternating current, constant voltage variable ampereage, or alternating current, variable voltage, constant ampereage):

##### Character of current.

Number of conductors leading out of station.

Size of conductors in circular mils.

Current carried—highest voltage; highest ampereage.

#### More Cable Service.

And yet two more links in the chain which, since the 3d of April, 1881, have been so gradually but so surely taking form and shape along the busy streets of this cosmopolitan city. As the pioneer, the cable railway which girdles the streets of the South Division, had almost every conceivable obstacle, except (in) finance, to overcome. But as vim and capital was behind the project, their touch, as always, enabled the enterprise to round out its thirty six miles of cable lines in the fall of 1887.

Next in order, as selected, not as demanded, came the North Division street railway cable enterprise. These lines have for the past three years made an honest effort to overcome defects which certain lines of economy always entail. And the GAZETTE is glad that an assimilation of conditions has enabled this company to bring its twenty-two lineal miles of cable railway nearly up to the high standard which thorough efficiency demands. The novelty which a ride through subterranean ways always gives has contributed not a little toward the income of the company. This will be better understood when it is remembered that 40 per cent. of all street railway traffic, in this city especially, is made up of passengers on pleasure bent. Right here it may be suggested to the management that tired workers of brain and brawn must have the rest which, in the season, they best secure by an evening ride on the grip, and for their further entertainment wisdom points to a judicious expenditure of capital for, or in the erection of, trysting places which give the purer enjoyments of the club, and which will more the surely, in conjunction with the evening ride, prepare brain and body for the sleep which is so essential for the successful prosecution of the duties of another day.

The outside world has taken upon itself to extend to Chicago an unsolicited sympathy, on account of, as they say, her resistless and restless activity, accusing her of the inability to bear with patience the fulfilment of long-deferred hopes. But really, gentlemen of the outside world, your sympathies are entirely uncalled for. The stoic could not more patiently wait for the realization of his hopes than have we waited these long, weary months for the building of our cable railways. And now come two more new lines, spanning the immense field of the West Division of the city. Milwaukee avenue, from the northwest, with its trains crowded with artisans, meets Madison street from the west, and together they glide under the river, and around the convenient business loops, thus typifying most gracefully and naturally the ceaseless energy of our people.

Nothing in steam or street construction can exceed the style to which, as it appears, every employe from laborer to president has so honestly contributed; and when it is known that, in street railway parlance, the synonyms of style are durability and economy, all should rejoice with us that the West Division corporation has builded so much better than they thought. Candidly and in detail we, after a careful survey of their roads, must credit them with better gradients, lines and curves than are to be found in any other city or any other division of this city.

How much of this is to be accredited to the power of example may be inferred, when it is known that three of the principal employes of the North Division lines insisted, on the trial trip of the State street cable in the winters of 1881 and 1882, that cable building was the folly of the nineteenth century.

"Why," said the only one of the two now in



the service, "the grip car will jump the track, and if it does, no ordinary means will replace it. Horse roads are good enough for me."

The writer of this article well remembers (and the Chicago Tribune will endorse him) how futile appeared to be his efforts to establish loop lines on the identical streets which are so gracefully traversed by the cables of to-day, thus relegating the street stable of the standing horse car to the primitive past.

Onward and onward always is the rule of Chicago's roads. Neither sunshine nor shower obstructs for an instant the passage of our people from one part of the city to the other, whether on business or pleasure bent. If our friends in other cities will emulate our example, as shown in our urban and suburban endlessness, we bespeak for them the same well-merited praise that is so justly meted out to the managers and employes of our cable railway service.

W. L. S. B.

**A Scenic Road Opened.**

The first complete trip over the Neversink Mountain railway was made on the afternoon of the 23d inst., and it opened up to the public one of the grandest rides in the country. The trial trip was made by an invited party in charge of Henry Kendall and George F. Baer, among which were several members of the daily press and a representative of the STREET RAILWAY GAZETTE. At Klappertal, the dynamo station was inspected. This is situated close to the Big dam, which furnishes the power. There are two dynamos in the station, each of 107-horse power. The plant is very complete, and with the machinery now there sufficient electrical power can be generated to run two such roads.

The car house and station of the company is located several hundred feet north of the dynamo station, and at that point the party boarded a handsome car, which is entered at the end like an ordinary car, but having open sides, so as to afford an unobstructed view. The car was in charge of Mr. W. A. Stadelman, chief engineer, and S. L. Nicholson, inspector, of the Equitable Electrical Construction Co., which constructed the road.

The scenery commences from the beginning of the road, and steadily expands until the car reaches the highest point, where it spreads out into a magnificent panorama that command one's surprise and admiration. After leaving the station, the car glides up the mountain in a serpentine course until it reaches the southern side. It crosses over a high, but thoroughly safe, trestle, and reaches Klappertal park, a rugged and romantic spot in the heart of the mountain. Here a pretty passenger station is to be built.

Then the car glides onward, turns a sharp curve, and in another moment the beautiful Schuylkill Valley is unfolded to the view. The scenery for the next half hour cannot be surpassed anywhere in the country. It is one continuous and expanding view, which grows more interesting as the car moves forward. The river, as it flows through the center of the picture in its fantastic course, adds a charm to the scene that makes it complete. Thirty miles to the west, in the hazy air surrounding the Blue mountains, can be seen the Gap. Further to the left can be seen the Robesonia furnaces, and southward is discerned the smoke from the big iron mills at Phoenixville.

The car made a stop at Moses' Rock, where a huge rock towers up alongside the track, and a stream of clear water flows from it. An iron pipe has been inserted and the water is caught in large tanks. Then comes Lover's Leap, where is added to the already extensive scenery a view of the city and the valley north of it. A station will also be erected at this point, which is one of the prettiest on the line.

Leaving Lover's Leap, the car in a few moments passes directly in front of the Highland house and all the while ascending, until, a quarter of a mile beyond, Point Lookout is reached. This is the highest point, and the finest place of observation. It is on top of the mountain, 755 feet above the river, which flows along the base. After that point is left behind, the car rolls down the northern side of the mountain, through Hiener's Wissel, past the Highland house once more, only lower down, and then reaches the

White house, where it is switched to Ninth street. The grades are easy and safe and the cars comfortable.

On the trip the car was stopped a number of times and took on parties of straggling picnickers. The guests at the Highland were also invited on board, and by the time it reached Ninth and Penn the car contained about sixty ladies and gentlemen, all of whom were highly delighted. The ride from Klappertal, including stops, occupied one hour and sixteen minutes. Ninth street was lined with spectators from Laurel to Penn. A second car came over the road an hour later, and then returned to the station at Klappertal.

As an engineering feat, the construction of this railway is far above the ordinary, as can be seen from the diagram and description of the road shown in the April issue of the STREET RAILWAY GAZETTE. Many apparently insurmountable difficulties were overcome, and these were some of the things that delayed its completion. It cuts its way through the wildest and most rugged mountain paths, over cliffs and along precipices, but it is so substantially built that accidents are well nigh impossible.

**An All-Copper Road.\***

In electric railways with overhead wires, the resistance of the ground return and the consequent loss of energy will depend largely on the connection between adjoining rails. The various forms of rail-bonds now in use are made wholly or in part of iron, and still leave better

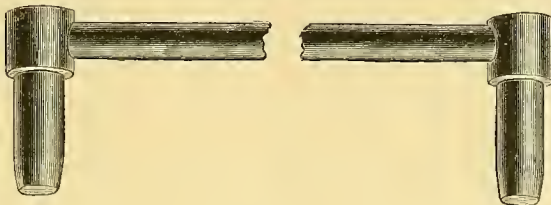

conductivity to be desired. To fill this want, a rail-bond made entirely of copper has been placed upon the market. The cut shows the two end pieces and part of the connecting wire full size. The taper pieces fit into holes drilled in the rails, and when upset in place they form a good metallic connection. The connecting piece can be made of any desired diameter and length, to suit the different circumstances, and can be bent to meet any unusual change. This rail-bond does away with the brass and iron pieces formerly used, and should give a joint of practically no resistance.

**Cable Railways—Their Defects and Remedies.**

(Continued from page 112)  
SWITCHES VS. LOOPS.

The first defects in all switches are that they are too abbreviated, they are in fact about 50 per cent. too short for continued daily service or use. The repair account of the rolling stock which is "jirked" through these unmechanical vices will furnish you all the required proof of the above.

Animal motorage is slipshod and antiquated, while the devices for cross cabling are too intricate, too costly and too unreliable to be considered beside the transfer loop. The loop, while making a perfect transfer, is the best collector of passengers that has ever been devised, running at six miles per hour passengers are quietly and safely taken from residence or business to the swift flying main. This division of the system, aside from its first cost, is operated by rowed power, and at a very light percentage of cost for repairs, while it is pre-eminently the place for reserved seats without extra charge.

**RAIL JOINTS.**

If anything could better illustrate the utter fallacy of using Portland or any cement where direct or indirect contact with wheel or hoof traffic is unavoidable, it is the experience of one of the great cable lines of Chicago. The road engineer of the company seems determined that he will have good joints, and it must be confessed that he has succeeded for certainly he has the

\* Great Western Electric Supply Co., Chicago.

finest surfaces in the street railway world. But at what a continuous cost? A cost that would almost ruin a less favored corporation. His methods of repair are to place a wrought iron section of heavy bar iron under the joints in manner and form similar to the use of the big flat cast iron shoe or chair in vogue whenever a flat tram rail is used. His first error was in assuming that Portland cement concrete could, under any circumstances, give him the solid foundation without which his money would go for naught. His second error is in using iron shavings for shimming—of course this only adds to the thickness of the shoe at the expense of the concrete, which is crowded out. If the crowding out process could be continued deep enough, we would write the method a success. But we are making history, and history has never yet written limestone a success, whether the material be natural or artificial as is Portland cement concrete. The general and specific remedy is to combine the fish plates and the shoe in one continuous whole in shape and in effect a wrap or fold which shall have in itself more metal than is indicated in the cross section of the rail itself.

**PAVING.**

In discussing this important question we propose to consider all kinds of material, whether used on cable railways or not; so that first in antiquity we find the everlasting boulder or cobble stone. First in years of service and first in health for horses, this material furnished at a comparatively small cost and laid in the best cement—gravel as a bond cannot stand the traffic of large cities, and the result is an endless and expensive relaying at too frequent intervals.

Wood block paving is noiseless, and for this reason, in some localities, companies, in order to obtain the right of way on certain streets, are obliged to stipulate that nothing but wood block pavement shall be used. The noiselessness of this material is the only commendable feature it claims; because it is a standing menace to health; costly because short-lived, and liable at any time to give the companies using it all the experiences of a corduroy road.

Of Asphalt it is enough in this connection to say, that those people wisely refrain from offering their peculiar goods to the managers of street railways.

But it is to magnesian limestone used as macadam, that we bow for its superior swiftness in disintegrating, and the rapidity with which it is ruined, has led us to give its history in a "1, 2, 3, 4" order, which should not be quickly forgotten:

- First—It is ground to powder by traffic.
- Second—Disintegrated by rains.
- Third—Dried up by the heat of the sun.
- Fourth—Blown away by the winds.

The Silicate limestone is 50 per cent. better, but has no place in the tracks of our street railways.

**THE PATENT BRICK**

manufactured from a clay compound of fire-clay and iron has many advocates. Its crushing resistance is about 20,000 lbs. to the square inch and when uniform in "hardness" it is a good and handsome paving for residence streets upon which heavy wheeled traffic does not go. But for other streets its use is wholly out of the question. This material is laid at \$2 per square yard, and has about eight years insured life to its credit.

Composite stone has been offered, but where the composition has one Portland cement and eight limestone parts there is really no life in them. Even so, of the asphalt compounds, they cannot be sold to an experienced manager of street railway lines.

But now comes "a new thing under the sun," and a composite stone is manufactured with the commercially pure silica, known as Sioux Falls quartzite, which is chemically made up of 96.50 per cent. pure silica and 3.50 per cent. of iron and alumina.

Another quartzite is found in Berlin, another at Devil's Lake, another at Green Lake, another at Portland. All these members of the quartz family are natives of Wisconsin. As no two members of the human family exactly resemble each other, neither do these of the quartzite family.

(Continued on page 135.)



# The Street Railway Gazette.

S. L. K. MONROE, - - - - - MANAGER.  
 E. V. CAYELL, - - - - - EDITOR.  
 EDWARD J. LAWLESS, - - - - ASSOCIATE EDITOR.  
 W. L. S. BAYLEY, - - - - - MECHANICAL EXPERT.

**GENERAL OFFICES:**

**CHICAGO:**

8 LAKESIDE BUILDING.

AGENCIES } San Francisco, - - - 1222 Bush Street.  
 } Toronto (Canada), - - - 53 Magill Street.  
 Cable Address=TRAM, CHICAGO.

*Annual Subscription (Including Postage).*

	Per Copy
United States, Canada, .....	\$2.00. .... 25c.
Great Britain, Ireland, India, Australia 10s. ....	1s.
Germany .....	9mk. 75 pf. .... 89pf.
France, Belgium, Switzerland.....	2fr. 95c. .... Fr 1.10.
Spain .....	21ps. 95c. .... Ps 1.10.
Austria, Holland.....	6fl. 74c. .... 55c.
Italy .....	12 lire. .... 1½ lira.
Venezuela .....	12 boliviar. .... 1½ bol.
Mexico.....	\$3.00. .... 30c.

Annual Subscriptions in Argentine Republic, 2½ peso; Brazil, milreals; Turkey, 54 piasters.

[Entered at the Chicago post-office as second-class matter.]

\* \*

Matter for publication should reach the Chicago Office not later than the last day of each month. All communications should be addressed, THE STREET RAILWAY GAZETTE, Chicago, Ill.

**The Census and Electricity.**

An examination of the questions given in full elsewhere in this issue were promulgated by Henry C. Adams of Ann Arbor, Mich., Special Agent of the Census office for the collection of statistics relating to transportation, will show what immense importance the electric railway industry has attained.

The general plan of the questions put is ingenious, and, if successfully carried out, will show very nearly the exact magnitude of the street railway industry, as regards mileage, equipment, number of employes, amount of capital invested, the number of passengers carried, etc.—the significance of rapid transit facilities as a factor in the life of cities, together with the relative efficiency and economy of the various kinds of motive power.

As street railways contribute in a variety of ways to the bearing of public expense, it is to be hoped that the Census Bureau will receive the hearty co-operation of Street Railway Managers in its endeavors to collect the information it seeks.

**Cape May Convention.**

The semi-annual convention of the National Electric Light Association, will be called to order in the large ball room of the Stockton Hotel, Cape May, N. J., at 10 a. m., Tuesday August 19th.

The following named papers will be read to the convention.

“Electrical Industries and the World’s Columbian Fair”—J. P. Barrell.

“Electric Light as applied to Steam Railroad”—N. H. Markland.

Standards of Economy in the Generation of Power and Steam Under Best Conditions—Editor of Power and Steam.

Triple Expansion High Speed Engines for Central Station Work—Williams.

The Model Boiler room and the Duties of a Fireman—Jarvis B. Edson.

Ferranti Station, London, England—Caryl Haskins.

The Proper Care and Management of Alternating Currents—T. Carpenter Smith.

Distribution of Energy by Alternating Currents and Transformers, and the proper method of Proportioning Conductors—A. L. Rohrer.

The Proper Basis for Determining Electric Motor Rates—H. L. Lufkin.

Actual Cost of Furnishing Arc Lighting (1200 and 2000 candle-power lamps) Under the Best Possible Conditions—J. C. Ayer.

Municipal Ownership of Electric Lighting Plants—M. J. Francisco.

Accidents in Electric Lighting Stations and Plants—Prof. Charles R. Cross.

Care and Labor in Electric Light Stations and Its Value—A. J. DeCamp.

How Can the National Electric Light Association Best Serve the Interests of Central Station Companies—C. R. Huntley.

The following committees will submit reports:  
 Committee on National Insurance Rules: George Cutter, Chairman.

Committee on Electrical Data: A. J. DeCamp, Chairman.

Committee on Copper Tariff: Charles A. Brown, Chairman.

Committee on Underground Conduits and Conductors: Joseph E. Lockwood, Chairman

Committee on Revision of Constitution: M. J. Francisco, Chairman.

National Committee on Legislation: Allen R. Foote, Chairman.

Committee on Relations between Manufacturing and Central Station Companies: Marsden J. Perry, Chairman.

Executive Committee: C. R. Huntley, Chairman.

Finance Committee: John A. Seely.

Secretary and Treasurer’s Report: Allen R. Foote.

About 150 rooms have already been engaged in advance, and it is expected that the attendance will be larger than at any previous Convention.

**“Key Streets.”**

On June 23d a letter, of which the following is a copy, reached this office:

OFFICE OF SAN ANTONIO STREET RAILWAY COMPANY,  
 SAN ANTONIO, TEX., JUNE 20, 1890.

EDITOR STREET RAILWAY GAZETTE.

DEAR SIR:—In an ordinance granted to us by the city a few days ago the following section appears: “----- that S----- street and A----- street, formerly granted to said company, shall be used as key streets-----” this raises a new question in railroading here, and we desire that you give us your idea of the term “key street,” it being a question of practical railroading.

What privilege, if any does this restriction give other street railway lines that are now or may be constructed and operated here over our tracks on those designated “key street” or “key streets,” and what power remains in the city authorities?

Does it mean that the city authorities reserve the right to admit other lines over the same street or streets, not disturbing our tracks, or does it mean that other companies shall have the use of our tracks on those designated “key street” or “key streets”?

There has never been any expression from the city authorities defining what they mean by “key streets;” it is not named as a “key line,” but simply “key streets.”

The fact of your being largely interested in street railroading, and, as we are informed, always ready to aid in giving information in this direction sought by other companies, prompts us to trouble you with the above inquiry, and we trust that we may hope for your usual kind and prompt attention in the matter.

Assuring you in advance of our appreciation, and holding ourselves in readiness to reciprocate at any time, we beg to remain yours very truly,

W. H. WEIS, President.

And two days later the following reply was transmitted by us direct to Mr. Weis:

OFFICE OF THE STREET RAILWAY GAZETTE,  
 CHICAGO, ILL., JUNE 25, 1890.

W. H. WEIS, ESQ.,  
 PRES. SAN ANTONIO STREET RY. CO.,  
 SAN ANTONIO, TEX.

DEAR SIR;—Answering your esteemed favor of the 20th inst. it is a little difficult to locate the word “key” as it is used by your city council, but in *law* it is “a donation”—“a gift”—a release of certain privileges, subject to such modifications as are necessary to extend the one and protect the other’s right.

“Quay,” or “key,” is a landing for goods or passengers, but not such a landing as would exclude another—ship, train or car—from its use, providing it is unoccupied by the original donee, and providing proper rentals are paid.

This, we think, does not allow your city council to abridge your own rights, but it may extend to another certain “keys” to certain streets, which it would only do by subordinating these rights to you.

Trusting that this information may serve your purpose, and awaiting your further valued advices, we are, etc.,

THE STREET RAILWAY GAZETTE.

In looking over our August exchanges we notice that Mr. Weis also applied to one of our contemporaries for this same information, and as that contemporary acknowledges its inability to solve the problem and requests its readers to assist it, we publish the foregoing.

**Remarkable Coincidence.**

That “imitation is the sincerest flattery” is generally conceded. That the same idea has frequently occurred to more than one man at precisely the same time is well known; but we have yet to learn of a well authenticated case where precisely the same phraseology has been used by two journals, located nearly 1,000 miles apart, in treating the same technical subjects.

Yet truth is often stranger than fiction, as is exemplified in the following

**“DEADLY PARALLELS.”**

[The Car, August, 1890, Page 27.]

CONTRIBUTORY NEGLIGENCE.—The tracks of defendant’s cable railway are placed so near together that cars going in opposite directions come within two feet of each other. Plaintiff, who sues for personal injuries, stood between the tracks for the purpose of taking a car, and was injured by two cars passing each other where he stood. The testimony shows that the gripman operating one of the cars saw plaintiff, and could readily have stopped his car before the accident occurred, but made no effort to slack his speed until within about ten feet of him. The judgment was for plaintiff and appeal by defendant. The court say: “A question is presented whether the important facts do not show that the plaintiff was guilty of contributory negligence. The plaintiff was acquainted with the situation, and must have known that the train might be expected on the track going west at any time. He must have known that as the car he was going to take should come to a stop, and until he could get on it, it would necessarily obstruct any attempt that might be necessary to get out of the way of the car passing on the other track. He must have known that to occupy such a position involved danger to himself. There was nothing to prevent him from seeing the other train. No sudden emergency is shown to have arisen to affect the plaintiff’s conduct or to attract his attention; no occasion for hasty or thoughtless action. That the plaintiff deliberately placed himself in a position which subjected him to the danger of serious injury unless he should guard himself by watchfulness is, we think, so apparent that a contrary conclusion would be unreasonable under these circumstances. The conclusion that the plaintiff appears to have been guilty of contributory negligence can not, upon the facts as they now appear, be avoided.”—Miller v. St. Paul City Railway Co., S. C. of Minn., February 7, 1890.

[The Car, August, 1890, Page 27.]

CONTRIBUTORY NEGLIGENCE.—Miller v. St. Paul City Railway Company; Supreme Court of Minnesota, Feb. 7, 1890.

The tracks of defendant’s cable railway are placed so near together that cars going in opposite directions come within two feet of each other. Plaintiff, who sues for personal injuries, alleging negligence of defendant, stood between the tracks for the purpose of taking a car, and was injured by two cars passing each other where he stood. The testimony shows that the gripman operating one of the cars saw plaintiff, and could readily have stopped his car before the accident occurred, but made no effort to slack his speed until within about ten feet of him. The judgment was for plaintiff and appeal by defendant. The court say: “A question is presented whether the important facts do not show that the plaintiff was guilty of contributory negligence. The plaintiff was acquainted with the situation, and must have known that the train might be expected on the track going west at any time. He must have known that as the car he was going to take should come to a stop, and until he could get on it, it would necessarily obstruct any attempt that might be necessary to get out of the way of the car passing on the other track. He must have known that to occupy such a position involved danger to himself. There was nothing to prevent him from seeing the other train. No sudden emergency is shown to have arisen to affect the plaintiff’s conduct or to attract his attention; no occasion for hasty or thoughtless action. That the plaintiff deliberately placed himself in a position which subjected him to the danger of serious injury unless he should guard himself by watchfulness is, we think, so apparent that a contrary conclusion would be unreasonable under these circumstances. The conclusion that the plaintiff appears to have been guilty of contributory negligence can not, upon the facts as they now appear, be avoided.”—Miller v. St. Paul City Railway Co., S. C. of Minn., February 7, 1890.

[The Car, August, 1890, Page 27.]

CONTRIBUTORY NEGLIGENCE.—Miller v. St. Paul City Railway Company; Supreme Court of Minnesota, Feb. 7, 1890.

The tracks of defendant’s cable railway are placed so near together that cars going in opposite directions come within two feet of each other. Plaintiff, who sues for personal injuries, alleging negligence of defendant, stood between the tracks for the purpose of taking a car, and was injured by two cars passing each other where he stood. The testimony shows that the gripman operating one of the cars saw plaintiff, and could readily have stopped his car before the accident occurred, but made no effort to slack his speed until within about ten feet of him. The judgment was for plaintiff and appeal by defendant. The court say: “A question is presented whether the important facts do not show that the plaintiff was guilty of contributory negligence. The plaintiff was acquainted with the situation, and must have known that the train might be expected on the track going west at any time. He must have known that as the car he was going to take should come to a stop, and until he could get on it, it would necessarily obstruct any attempt that might be necessary to get out of the way of the car passing on the other track. He must have known that to occupy such a position involved danger to himself. There was nothing to prevent him from seeing the other train. No sudden emergency is shown to have arisen to affect the plaintiff’s conduct or to attract his attention; no occasion for hasty or thoughtless action. That the plaintiff deliberately placed himself in a position which subjected him to the danger of serious injury unless he should guard himself by watchfulness is, we think, so apparent that a contrary conclusion would be unreasonable under these circumstances. The conclusion that the plaintiff appears to have been guilty of contributory negligence can not, upon the facts as they now appear, be avoided.”—Miller v. St. Paul City Railway Co., S. C. of Minn., February 7, 1890.

[The Car, August, 1890, Page 27.]

CONTRIBUTORY NEGLIGENCE.—Miller v. St. Paul City Railway Company; Supreme Court of Minnesota, Feb. 7, 1890.

The tracks of defendant’s cable railway are placed so near together that cars going in opposite directions come within two feet of each other. Plaintiff, who sues for personal injuries, alleging negligence of defendant, stood between the tracks for the purpose of taking a car, and was injured by two cars passing each other where he stood. The testimony shows that the gripman operating one of the cars saw plaintiff, and could readily have stopped his car before the accident occurred, but made no effort to slack his speed until within about ten feet of him. The judgment was for plaintiff and appeal by defendant. The court say: “A question is presented whether the important facts do not show that the plaintiff was guilty of contributory negligence. The plaintiff was acquainted with the situation, and must have known that the train might be expected on the track going west at any time. He must have known that as the car he was going to take should come to a stop, and until he could get on it, it would necessarily obstruct any attempt that might be necessary to get out of the way of the car passing on the other track. He must have known that to occupy such a position involved danger to himself. There was nothing to prevent him from seeing the other train. No sudden emergency is shown to have arisen to affect the plaintiff’s conduct or to attract his attention; no occasion for hasty or thoughtless action. That the plaintiff deliberately placed himself in a position which subjected him to the danger of serious injury unless he should guard himself by watchfulness is, we think, so apparent that a contrary conclusion would be unreasonable under these circumstances. The conclusion that the plaintiff appears to have been guilty of contributory negligence can not, upon the facts as they now appear, be avoided.”—Miller v. St. Paul City Railway Co., S. C. of Minn., February 7, 1890.

[The Car, August, 1890, Page 27.]

CONTRIBUTORY NEGLIGENCE.—Miller v. St. Paul City Railway Company; Supreme Court of Minnesota, Feb. 7, 1890.

The tracks of defendant’s cable railway are placed so near together that cars going in opposite directions come within two feet of each other. Plaintiff, who sues for personal injuries, alleging negligence of defendant, stood between the tracks for the purpose of taking a car, and was injured by two cars passing each other where he stood. The testimony shows that the gripman operating one of the cars saw plaintiff, and could readily have stopped his car before the accident occurred, but made no effort to slack his speed until within about ten feet of him. The judgment was for plaintiff and appeal by defendant. The court say: “A question is presented whether the important facts do not show that the plaintiff was guilty of contributory negligence. The plaintiff was acquainted with the situation, and must have known that the train might be expected on the track going west at any time. He must have known that as the car he was going to take should come to a stop, and until he could get on it, it would necessarily obstruct any attempt that might be necessary to get out of the way of the car passing on the other track. He must have known that to occupy such a position involved danger to himself. There was nothing to prevent him from seeing the other train. No sudden emergency is shown to have arisen to affect the plaintiff’s conduct or to attract his attention; no occasion for hasty or thoughtless action. That the plaintiff deliberately placed himself in a position which subjected him to the danger of serious injury unless he should guard himself by watchfulness is, we think, so apparent that a contrary conclusion would be unreasonable under these circumstances. The conclusion that the plaintiff appears to have been guilty of contributory negligence can not, upon the facts as they now appear, be avoided.”—Miller v. St. Paul City Railway Co., S. C. of Minn., February 7, 1890.

[The Car, August, 1890, Page 27.]

CONTRIBUTORY NEGLIGENCE.—Miller v. St. Paul City Railway Company; Supreme Court of Minnesota, Feb. 7, 1890.

The tracks of defendant’s cable railway are placed so near together that cars going in opposite directions come within two feet of each other. Plaintiff, who sues for personal injuries, alleging negligence of defendant, stood between the tracks for the purpose of taking a car, and was injured by two cars passing each other where he stood. The testimony shows that the gripman operating one of the cars saw plaintiff, and could readily have stopped his car before the accident occurred, but made no effort to slack his speed until within about ten feet of him. The judgment was for plaintiff and appeal by defendant. The court say: “A question is presented whether the important facts do not show that the plaintiff was guilty of contributory negligence. The plaintiff was acquainted with the situation, and must have known that the train might be expected on the track going west at any time. He must have known that as the car he was going to take should come to a stop, and until he could get on it, it would necessarily obstruct any attempt that might be necessary to get out of the way of the car passing on the other track. He must have known that to occupy such a position involved danger to himself. There was nothing to prevent him from seeing the other train. No sudden emergency is shown to have arisen to affect the plaintiff’s conduct or to attract his attention; no occasion for hasty or thoughtless action. That the plaintiff deliberately placed himself in a position which subjected him to the danger of serious injury unless he should guard himself by watchfulness is, we think, so apparent that a contrary conclusion would be unreasonable under these circumstances. The conclusion that the plaintiff appears to have been guilty of contributory negligence can not, upon the facts as they now appear, be avoided.”—Miller v. St. Paul City Railway Co., S. C. of Minn., February 7, 1890.

[The Car, August, 1890, Page 27.]

CONTRIBUTORY NEGLIGENCE.—Miller v. St. Paul City Railway Company; Supreme Court of Minnesota, Feb. 7, 1890.

The tracks of defendant’s cable railway are placed so near together that cars going in opposite directions come within two feet of each other. Plaintiff, who sues for personal injuries, alleging negligence of defendant, stood between the tracks for the purpose of taking a car, and was injured by two cars passing each other where he stood. The testimony shows that the gripman operating one of the cars saw plaintiff, and could readily have stopped his car before the accident occurred, but made no effort to slack his speed until within about ten feet of him. The judgment was for plaintiff and appeal by defendant. The court say: “A question is presented whether the important facts do not show that the plaintiff was guilty of contributory negligence. The plaintiff was acquainted with the situation, and must have known that the train might be expected on the track going west at any time. He must have known that as the car he was going to take should come to a stop, and until he could get on it, it would necessarily obstruct any attempt that might be necessary to get out of the way of the car passing on the other track. He must have known that to occupy such a position involved danger to himself. There was nothing to prevent him from seeing the other train. No sudden emergency is shown to have arisen to affect the plaintiff’s conduct or to attract his attention; no occasion for hasty or thoughtless action. That the plaintiff deliberately placed himself in a position which subjected him to the danger of serious injury unless he should guard himself by watchfulness is, we think, so apparent that a contrary conclusion would be unreasonable under these circumstances. The conclusion that the plaintiff appears to have been guilty of contributory negligence can not, upon the facts as they now appear, be avoided.”—Miller v. St. Paul City Railway Co., S. C. of Minn., February 7, 1890.

[The Car, August, 1890, Page 27.]

CONTRIBUTORY NEGLIGENCE.—Miller v. St. Paul City Railway Company; Supreme Court of Minnesota, Feb. 7, 1890.

The tracks of defendant’s cable railway are placed so near together that cars going in opposite directions come within two feet of each other. Plaintiff, who sues for personal injuries, alleging negligence of defendant, stood between the tracks for the purpose of taking a car, and was injured by two cars passing each other where he stood. The testimony shows that the gripman operating one of the cars saw plaintiff, and could readily have stopped his car before the accident occurred, but made no effort to slack his speed until within about ten feet of him. The judgment was for plaintiff and appeal by defendant. The court say: “A question is presented whether the important facts do not show that the plaintiff was guilty of contributory negligence. The plaintiff was acquainted with the situation, and must have known that the train might be expected on the track going west at any time. He must have known that as the car he was going to take should come to a stop, and until he could get on it, it would necessarily obstruct any attempt that might be necessary to get out of the way of the car passing on the other track. He must have known that to occupy such a position involved danger to himself. There was nothing to prevent him from seeing the other train. No sudden emergency is shown to have arisen to affect the plaintiff’s conduct or to attract his attention; no occasion for hasty or thoughtless action. That the plaintiff deliberately placed himself in a position which subjected him to the danger of serious injury unless he should guard himself by watchfulness is, we think, so apparent that a contrary conclusion would be unreasonable under these circumstances. The conclusion that the plaintiff appears to have been guilty of contributory negligence can not, upon the facts as they now appear, be avoided.”—Miller v. St. Paul City Railway Co., S. C. of Minn., February 7, 1890.

[The Car, August, 1890, Page 27.]

CONTRIBUTORY NEGLIGENCE.—Miller v. St. Paul City Railway Company; Supreme Court of Minnesota, Feb. 7, 1890.

The tracks of defendant’s cable railway are placed so near together that cars going in opposite directions come within two feet of each other. Plaintiff, who sues for personal injuries, alleging negligence of defendant, stood between the tracks for the purpose of taking a car, and was injured by two cars passing each other where he stood. The testimony shows that the gripman operating one of the cars saw plaintiff, and could readily have stopped his car before the accident occurred, but made no effort to slack his speed until within about ten feet of him. The judgment was for plaintiff and appeal by defendant. The court say: “A question is presented whether the important facts do not show that the plaintiff was guilty of contributory negligence. The plaintiff was acquainted with the situation, and must have known that the train might be expected on the track going west at any time. He must have known that as the car he was going to take should come to a stop, and until he could get on it, it would necessarily obstruct any attempt that might be necessary to get out of the way of the car passing on the other track. He must have known that to occupy such a position involved danger to himself. There was nothing to prevent him from seeing the other train. No sudden emergency is shown to have arisen to affect the plaintiff’s conduct or to attract his attention; no occasion for hasty or thoughtless action. That the plaintiff deliberately placed himself in a position which subjected him to the danger of serious injury unless he should guard himself by watchfulness is, we think, so apparent that a contrary conclusion would be unreasonable under these circumstances. The conclusion that the plaintiff appears to have been guilty of contributory negligence can not, upon the facts as they now appear, be avoided.”—Miller v. St. Paul City Railway Co., S. C. of Minn., February 7, 1890.

[The Car, August, 1890, Page 27.]

CONTRIBUTORY NEGLIGENCE.—Miller v. St. Paul City Railway Company; Supreme Court of Minnesota, Feb. 7, 1890.

The tracks of defendant’s cable railway are placed so near together that cars going in opposite directions come within two feet of each other. Plaintiff, who sues for personal injuries, alleging negligence of defendant, stood between the tracks for the purpose of taking a car, and was injured by two cars passing each other where he stood. The testimony shows that the gripman operating one of the cars saw plaintiff, and could readily have stopped his car before the accident occurred, but made no effort to slack his speed until within about ten feet of him. The judgment was for plaintiff and appeal by defendant. The court say: “A question is presented whether the important facts do not show that the plaintiff was guilty of contributory negligence. The plaintiff was acquainted with the situation, and must have known that the train might be expected on the track going west at any time. He must have known that as the car he was going to take should come to a stop, and until he could get on it, it would necessarily obstruct any attempt that might be necessary to get out of the way of the car passing on the other track. He must have known that to occupy such a position involved danger to himself. There was nothing to prevent him from seeing the other train. No sudden emergency is shown to have arisen to affect the plaintiff’s conduct or to attract his attention; no occasion for hasty or thoughtless action. That the plaintiff deliberately placed himself in a position which subjected him to the danger of serious injury unless he should guard himself by watchfulness is, we think, so apparent that a contrary conclusion would be unreasonable under these circumstances. The conclusion that the plaintiff appears to have been guilty of contributory negligence can not, upon the facts as they now appear, be avoided.”—Miller v. St. Paul City Railway Co., S. C. of Minn., February 7, 1890.

[The Car, August, 1890, Page 27.]

CONTRIBUTORY NEGLIGENCE.—Miller v. St. Paul City Railway Company; Supreme Court of Minnesota, Feb. 7, 1890.

The tracks of defendant’s cable railway are placed so near together that cars going in opposite directions come within two feet of each other. Plaintiff, who sues for personal injuries, alleging negligence of defendant, stood between the tracks for the purpose of taking a car, and was injured by two cars passing each other where he stood. The testimony shows that the gripman operating one of the cars saw plaintiff, and could readily have stopped his car before the accident occurred, but made no effort to slack his speed until within about ten feet of him. The judgment was for plaintiff and appeal by defendant. The court say: “A question is presented whether the important facts do not show that the plaintiff was guilty of contributory negligence. The plaintiff was acquainted with the situation, and must have known that the train might be expected on the track going west at any time. He must have known that as the car he was going to take should come to a stop, and until he could get on it, it would necessarily obstruct any attempt that might be necessary to get out of the way of the car passing on the other track. He must have known that to occupy such a position involved danger to himself. There was nothing to prevent him from seeing the other train. No sudden emergency is shown to have arisen to affect the plaintiff’s conduct or to attract his attention; no occasion for hasty or thoughtless action. That the plaintiff deliberately placed himself in a position which subjected him to the danger of serious injury unless he should guard himself by watchfulness is, we think, so apparent that a contrary conclusion would be unreasonable under these circumstances. The conclusion that the plaintiff appears to have been guilty of contributory negligence can not, upon the facts as they now appear, be avoided.”—Miller v. St. Paul City Railway Co., S. C. of Minn., February 7, 1890.

[The Car, August, 1890, Page 27.]

CONTRIBUTORY NEGLIGENCE.—Miller v. St. Paul City Railway Company; Supreme Court of Minnesota, Feb. 7, 1890.

The tracks of defendant’s cable railway are placed so near together that cars going in opposite directions come within two feet of each other. Plaintiff, who sues for personal injuries, alleging negligence of defendant, stood between the tracks for the purpose of taking a car, and was injured by two cars passing each other where he stood. The testimony shows that the gripman operating one of the cars saw plaintiff, and could readily have stopped his car before the accident occurred, but made no effort to slack his speed until within about ten feet of him. The judgment was for plaintiff and appeal by defendant. The court say: “A question is presented whether the important facts do not show that the plaintiff was guilty of contributory negligence. The plaintiff was acquainted with the situation, and must have known that the train might be expected on the track going west at any time. He must have known that as the car he was going to take should come to a stop, and until he could get on it, it would necessarily obstruct any attempt that might be necessary to get out of the way of the car passing on the other track. He must have known that to occupy such a position involved danger to himself. There was nothing to prevent him from seeing the other train. No sudden emergency is shown to have arisen to affect the plaintiff’s conduct or to attract his attention; no occasion for hasty or thoughtless action. That the plaintiff deliberately placed himself in a position which subjected him to the danger of serious injury unless he should guard himself by watchfulness is, we think, so apparent that a contrary conclusion would be unreasonable under these circumstances. The conclusion that the plaintiff appears to have been guilty of contributory negligence can not, upon the facts as they now appear, be avoided.”—Miller v. St. Paul City Railway Co., S. C. of Minn., February 7, 1890.



[July, 1890, Page 119.]  
**INFRINGEMENT OF CABLE PAT-  
 ENT.**—American Cable Railway  
 Company v. Chicago City Railway  
 Company; Circuit Court of the  
 United States, Northern District  
 of Illinois, February 10, 1890, 41  
 Fed. Rep. 522.

"This is a bill in equity praying  
 an injunction and accounting for  
 profits and damages by reason of  
 the alleged infringement of patent  
 No. 131,913, granted October 1,  
 1872, to Abel Thompson, for an  
 improvement in street railways."  
 Defendants demur to the bill on  
 the ground that it does not show  
 a case for the jurisdiction of a  
 court of equity, and because it  
 appears upon the face of the  
 patent, which is made a part of  
 the bill, that it is void for want  
 of patentable novelty. The bill  
 was filed on the 16th day of Sep-  
 tember, 1889, subpoena served on  
 the 17th day of the same month,  
 returnable on the first Monday in  
 October then next, which was on  
 the 7th day of the last named  
 month. Equity rule 17 requires  
 the defendant to appear on the  
 rule-day to which the subpoena is  
 made returnable, when the service  
 is made 20 days before that  
 day. By excluding the day of  
 service, and including the return-  
 day, which is the practice of this  
 court in computing time for this  
 purpose, this process was served  
 in time to require the appearance  
 of the defendant on the 7th day  
 of October. The patent was granted  
 on the 1st day of October, 1872,  
 and expired on the 1st day of Oc-  
 tober, 1889; so that the patent had  
 expired when the defendants  
 were required to appear, and  
 when, if they had been duly  
 served, and had not appeared,  
 they could have been defaulted.  
 In *Rout v. Railway Co.*, 105 U. S.  
 189, it was held that equity only  
 takes jurisdiction in suits for  
 the infringement of a patent  
 where the bill shows that part of  
 the complainant's remedy is the  
 right to an injunction, or some  
 special equitable relief, the founda-  
 tion for which is laid in the  
 bill. And in *Clark v. Wooster*,  
 119 U. S. 322, 7 Sup. Ct. 217, the  
 court clearly intimates that if no  
 injunction could have been ob-  
 tained the bill ought to be dis-  
 missed. In the case now in hand  
 the patent had fourteen days of  
 life when the bill was filed, and  
 no application for an injunction  
 pendente lite was made; and the  
 patent had expired before the re-  
 turn day of the process, and be-  
 fore the complainant would have  
 been entitled to a default, even  
 if the defendants had not appear-  
 ed and defended. As there is no  
 special case made by the bill  
 showing that an injunction was  
 part of the remedy to which the  
 complainant would be entitled by  
 reason of special facts alleged, it  
 follows that no injunction would  
 have been awarded by the court if  
 the complainant had obtained a  
 decree pro confesso. \* \*

[August, 1890, Page 29.]  
**INFRINGEMENT OF CABLE PAT-  
 ENT.**—This is a bill in equity  
 praying an injunction and ac-  
 counting for profits and damages  
 by reason of the alleged infringe-  
 ment of patent No. 131,913, grant-  
 ed October 1, 1872, to Abel  
 Thompson, for "an improvement  
 in street railways." Defendants  
 demur to the bill on the ground  
 that it does not show a case for  
 the jurisdiction of a court of  
 equity, and because it appears  
 upon the face of the patent, which  
 is made part of the bill, that it is  
 void for want of patentable novel-  
 ty. The bill was filed on the 16th  
 day of September, 1889, subpoena  
 served on the 17th day of the same  
 month, returnable on the first  
 Monday in October then next,  
 which was on the 7th day of the  
 last named month. Equity rule  
 17 requires the defendant to ap-  
 pear on the rule day to which the  
 subpoena is made returnable,  
 when the service is made 20 days  
 before that day. By excluding  
 the day of service, and including  
 the return day, which is the prac-  
 tice of this court in computing  
 time for this purpose, this process  
 was served in time to require the  
 appearance of the defendant on  
 the 7th day of October. The pat-  
 ent was granted on the 1st day of  
 October, 1872, and expired on the  
 1st day of October, 1889; so that  
 the patent had expired when the  
 defendants were required to ap-  
 pear, and when, if they had been  
 duly served, and had not appear-  
 ed, they could have been de-  
 faulted. In *Clark vs. Wooster*,  
 119 U. S. 322, Sup. Ct. 217, the  
 court clearly intimates that if no  
 injunction could have been ob-  
 tained the bill ought to be dis-  
 missed. In the case now in hand  
 the patent had fourteen days of  
 life when the bill was filed, and  
 no application for an injunction  
 pendente lite was made; and the  
 patent had expired before the re-  
 turn day of the process, and be-  
 fore the complainant would have  
 been entitled to a default, even  
 if the defendants had not appear-  
 ed and defended. As there is no  
 special case made by the bill  
 showing that an injunction was  
 part of the remedy to which the  
 complainant would be entitled by  
 reason of special facts alleg-d, it  
 follows that no injunction would  
 have been awarded by the court if  
 the complainant had obtained a  
 decree pro confesso.—A *Chicago  
 City Railway Company vs. Chi-  
 cago, Ill.*, Feb. 10, 1890.

years, and a first cost of \$2.50 laid, settles the question till a betterment comes in sight.

The subject of street railway pavements cannot be considered independently of the general conditions which surround this important improvement. What is good, what is wise, what is permanent and what is economical, is as desirable for the railways as for the city governments. Some few cable railway lines have secured in a remarkable degree, all the above mentioned essential conditions, not perhaps as a design to lay a better pavement, but because it is considered unsafe on cable or electric lines to allow any makeshifts or experiments on or within their tracks.

A displaced block of wood or loose macadam, fire clay brick or other composite, is liable to destroy property or life far in excess of the first cost of the best pavement.

One condition which makes cable railway paving strong arises from the fact that the concrete walls of the cable channels are often arched across so that the "between tracks" has the same Portland cement foundations; and even without the concrete, the massiveness of the structure is a warrant that the paving will be permanent.

At first granite blocks, pure and simple, costing with pitch and sand and gravel, \$4.65 per square yard, were long considered essential, but the discovery of the hard stone family of Wisconsin, Dakota and the Northwest, has given railway managers a better material than granite by 28 per cent. and what gladdens the heart of the superintendent, the price is reduced to \$2.75 and \$3.00 per square yard, laid in pitch.

Nothing that man has made in the composite line is ever considered good enough by street railway people, for their use.

This implies that all composites whether brick, asphalt or concrete or by whatever name the product be known, are tabooed by these thoughtful men.

Forty different combinations and designs for ideal pavements were offered at the late paving convention, held at Indianapolis in April last, but none were patronized except the old stand-by granite, or its newer and more powerful rival, quartzite. We do not hesitate to say that this last material has come to stay, and that granite must henceforth occupy the second place in values. But, not to be too confident in the assertion made that composites could not heretofore be made strong and elastic enough to serve as paving material, we are informed that company, in connection with a well-known civil engineer, thinks it can make a composite, using quartzite bonded by a material which is as yet a secret with it.

It claims that it shall be dust and wear proof and at the same time costing less than half of the original price of granite blocks.

**"Hit Him — He has no Friends."**

ASHTABULA, O., Aug. 9, 1890.

"Did any one ever hear of Ashtabula, Ashtabula Co., Ohio? It is situated on Lake Erie and near the Pennsylvania state line, and by some manner of means such a place exists and has within the past few days attained considerable notoriety as a most disagreeable place in which to do business, and the only place where an attempt has ever been made, on the part of a city council, to condemn and proceed to confiscate a man's property without judicial procedure at the hands of a competent court of equity."

Seeing the above notice and hearing of the peculiar state of affairs as briefly given above, your correspondent dropped in on the town, the streets of which look as though a cyclone of railroad material had been dumped along them, and learned the following facts:

Ten men and a mayor compose the governing body, great in its mightiness, called a "city council," who seem to consider themselves "judges," "jury," "lord high executors" in general and "Pooh Bahs" in particular, and proceed to make laws governing, and contracts binding, the city, and, in the triple capacity of a legislative, judicial and executive body, proceed in a most unceremonious and high-handed manner.

By granting to Mr. John N Stewart, of Cleveland, Ohio, a 25 year franchise, the people of this little hamlet succeeded, in 1883, in getting him to build a horse car railroad through half a dozen or more streets and to the lake, a distance of four miles.

This road was to have been completed and in operation within six months after the passage of the ordinance granting its construction.

Such a pressure was made for the immediate completion of the road that work was pushed right along and the road in operation in forty-five days. Nine cars were run and sixty horses employed, but after the first year's experience four cars were found to be sufficient for all ordinary business, and during two or three months of the winter two cars are amply able to accommodate all the travel.

For five years last past this road has been a "U. S. mail route." but the policy of retrenchment indulged in by the P. O. department compelled the road to give this up or carry the mails at a loss. Cars were run in accordance with the ordinance (once an hour between the hours of 6 a. m. and 10 p. m.) and much oftener when occasion required.

The rails were used and ballast of cinders and broken stone was placed between the rails, and varies in depth from one to four feet, making a substantial road between the rails, and over and upon this roadway all of the teaming over the four miles of road was done during the muggy seasons, as the highway on either side of the track was well nigh impassable.

A constant clamor has been made to compel Mr. Stewart to "re rail" his road with "tram" or "girder" rail, upon which wagons might travel, as well as street cars.

This he has persistently refused to do, as his ordinance only provides for a change in rail at such time as the streets through which the tracks pass are paved.

On December 3d, 1889, the council passed an ordinance setting forth that as Mr. Stewart had not performed or constructed his road, in accordance with the "ordinance of 1883" and had "insulted the city council" his rights under the franchise were declared "null and void," said ordinance repealed and the tracks should be removed from the streets.

This declaration of the council, without any investigation on their part, or any opportunity of allowing Mr. Stewart to say why judgment should not be pronounced, met with objections on his part, in the shape of an injunction to prevent any interference on the part of the council or its agents, with him in the operation of his road. A hearing in Chambers on the city's motion to dissolve the temporary restraining order was had on Saturday, July 19th, before common pleas—Judge Sherman—the father of the "city's solicitor" Sherman.

Before the hearing Stewart's attorney asked Judge Sherman if he ought not to be excused from hearing the case on account of his residence in, and relationship to the city, at which his Excellency became very indignant and said he was "insulted" and demanded that the argument go on, which it did, after which the Judge rose in his might and with apparent vindictiveness declared the injunction dissolved as he said, on account of the insufficiency of Stewart's petition for an injunction, which had been granted by the Judge of the Probate Court during the absence of Judge Sherman.

At this finding Mr. Stewart proceeded to address the Court, saying "that he hoped no misunderstanding between the Court and his attorney would prejudice his case," his investments had been very great in Ashtabula and he was reliably informed that the council through maliciousness proposed at the very first opportunity, without any authority at law and perhaps in defiance thereof to remove his tracks from the streets." This most Excellent Judge thereupon says "if as the parties claim they are taken by surprise I shall declare the injunction dissolved and the Journal entry to be made as of 'Monday, July 21st.'" Mr. Stewart notified the Court, as his attorney had previously done that he should "appeal from such finding" and "would be ready at the county seat at Jefferson, Ohio, on Monday, July 21st to do so." Half an hour later, Stewart was on his way by rail to Cleveland, and the city marshal and mayor and their attorneys were on their way to look up members of the council and at a meeting two hours later the eight members present passed a resolution instructing the mayor and marshal to cause the four miles of road to be removed at once.

Work began at eight o'clock the same evening and continued during the night, Sunday and Sunday night and Monday with between 300 and 400 men from the docks of the Penn company at the harbor, headed by the agent of the Penn company who, as a member of the city council, has proven himself the moving spirit, and in a recent letter of explanation to his employers which he caused to be published here in the local organ of the "Communist party" justifies his action and the official action of the council, on the ground that "His (Stewart's) advocates are few, and they are so few that they can be counted on the ends of your fingers." Of course the enormity of the crime of such high handed vandalism on the part of a city council is amply mitigated if a street railroad has so few friends that "they can be counted on the ends of your fingers," and on the same conclusions this man would "swing from the end of a rope" the managers of an enterprise if they hadn't any friends.

At its last meeting (very numerous just now), the council passed a resolution ordering "J. N. Stewart to remove his railroad material from the streets within fifteen days or the city would do so and charge Stewart the expense." This, too, is very laughable as that august body appears to have confiscated the entire property and material and a large part thereof they had already hauled away from the main streets. Mr. Stewart was not in Ashtabula when hostilities broke out on Saturday night and did not learn of the work going on until his return on Sun-day noon, at which time unusual efforts were made by him to assemble the circuit court judges who, during the vacation, were away from the county, and not until the following Tuesday noon, July 22nd, were Judges Woodburn and Laubie able to hear Stewart's appeal from the rulings of the lower court, and their findings were "that as all of the work sought to be enjoined had been performed, that there was, under the general rule of the court, nothing to restrain" and a continuance of the injunction was not allowed.

Mr. Stewart has attempted to relay the road, and with new material, and operate his street railroad, as he claims he has a perfect right to do for the remaining eighteen years of his grant, but the mayor assisted by the marshal and police force, prevented his doing so, insisting that no tracks shall be relaid.

The question of forfeiture of franchise and the right of extermination by the city council without judicial hearing, will be heard at the October term of court, also the suit

That our very esteemed contemporary, "The Car" of Philadelphia, should have been guilty of deliberate plagiarism is difficult for us to believe; but that it should have reproduced our exact language (as demonstrated in the foregoing) is certainly a "remarkable coincidence."

We shall be pleased to receive from "The Car" either an explanation of this unique coincidence or an acknowledgement of credit for matter copied from the "Gazette."

**Cable Railways—Their Defects and Remedies.**

(Continued from page 133.)

Yet none of them have any weakening element in their construction, except those which have had a volcanic origin, in which case an unfavorable element resembling mica in granite reduces their value. Ability to "cling" to the Portland cement bond, and thus produce, as in the case of Drake's Jasperite, a composite with 30,000 pounds crushing resistance, a material combining, in a degree, the strength of silica and the adaptability to form and beauty unequalled by the far famed shell roads.

Let us hope that those composites may be found to be the "missing link" which shall combine all of the best elements of road-making material—a material superior to many eastern granites on account of their "low hardness," and coming dangerously near the hewn blocks from the above mentioned quarries. But to-day it has not reached those blocks in the minds of street railway managers, and the natural quartzite yet stands pre-eminently the paving material of our day. Objections there are—they are rough and they are noisy, but with an insured life of 50



for \$100,000 damages which Mr. Stewart has brought against the city and all parties engaged in the destruction of his property.

Meantime there is no communication between town and harbor by street railway, although the merchants here were told by members of the council that a "tram" or "girder" railroad with electric cars would be put in as soon as "Stewart's Horse Railroad was annihilated," and, further, "the town could sell the valuable franchise," none of which appears to be in the immediate future.

Mr. Stewart maintains that any further trespassing upon his rights will be prosecuted, as will be the past acts, to the fullest extent of the law, claiming that if the time has now come that municipal authorities can at their own good pleasure, take possession of, and destroy property rights heretofore held sacred under the constitution, it is high time that the right to such vandalism be made known, that no fictitious valuation be placed on citizenship or ownership of property that may be reached by men clothed with official ermine, who may go forth—"Thieves in the night time seeking whom they may devour."

"Justice."

[As we go to press we learn that Mr. Stewart had printed and caused to be circulated a circular, of which the following is a copy.—EDITOR.]

#### NOTICE

To the Citizens and Traveling Public:

I regret to advise you of the (as I hope) temporary interruption of the facilities I have heretofore offered you in the way of transportation between the village and Harbor.

Seven years ago, in the utmost good faith, I constructed, and have since that time maintained, as well as it was possible to do, and at great annual expense, a Street Railroad over Main, Division, Station, Depot, Lake and Bridge streets, none of which, owing to the negligence and perverseness of the Council are or were placed to any sort of grade, as the Laws of Ohio say they shall be, and are therefore well nigh impassable one-half of every year.

On Saturday night last, during my absence from the village, and pending a hearing before the court, on Monday, July 21st, of the litigation between the village and myself, a gang of lawless and riotous vagabonds, led and advised by irresponsible men, enacted and executed in the name of the village the most high-handed and heretofore unheard of piece of incendiarism that ever disgraced any community.

On my return this morning I endeavored to repair the injury to my interests and establish communication over the road, but found that such an endeavor was thwarted by armed forces claiming to act in accordance with law, with which, rather than force an issue liable to result in the sacrifice of life, I concluded to abandon and passively wait the adjudication by the courts.

Meantime, while the situation is annoying in the extreme, I hope for your fair and unbiased indulgence, believing that my interests and the rights of the public will be fully substantiated at law.

JOHN N. STEWART.

#### Duquesne Traction Wins.

In the case of Lockhart et al. vs. the Craig Street Railway company and the Duquesne Traction company the following is the full decision handed down by Judge Stone.

The decision, stating the law as to the rights of abutters and the public, as it does, is a very important one, and will doubtless be used as a precedent:

Plaintiff's bill avers, in so far as is material to this application: That the plaintiffs are severally property owners of land abutting upon Negley avenue, in the city of Pittsburg.

That said avenue is an improved street of said city, paved only within the last year with smooth asphalt pavement, paid for by plaintiffs and other abutting property owners, at a cost of some \$132,000, and that the same was paved with the said asphalt pavement with a view and for the purpose of diminishing the noises and annoyances arising from travel on the same, and to increase the value of their lands on said street, as places of residence, and the result has been to greatly increase the value of said lands.

That the Craig Street Railway Company claims to have the right to enter upon and construct a street railway along and upon said Negley avenue from the intersection thereof with Roup street to the intersection thereof with Bryant street, and thence returning with a double track on Negley avenue to said intersection with Roup street.

That said Craig street Railway Company threatens and proposes to at once enter upon Negley avenue, to construct, maintain and operate a street railway with two tracks, etc., and to run thereon cars

#### PROPELLED BY ELECTRICITY

as a motive power, and for that purpose to tear up and destroy said pavement, and to replace the same with an inferior block pavement, and to erect along the lines of said street in the properties of plaintiffs, a line of poles on each side of said street, and to suspend wires from said poles across the carriage way of said street, and upon such poles to suspend a wire over each of the tracks running lengthwise of said street.

That such poles will be erected in such properties as defendants may elect, or about the curb lines of said street, at the height of about eighteen feet and about seventy-five feet apart, and the tracks to be laid will be about seven feet from the curb line, and that said poles and tracks will be a continual trespass upon said properties and a serious obstruction to the passage of said street; that it will deprive said plaintiffs of easy and convenient access to

the street from their properties, and prevent the use of their respective properties under the improvement of said street, etc., etc.

That the running of cars along said tracks by the use of electricity, will deprive plaintiffs of the quiet which they have heretofore enjoyed, and which makes their property especially valuable for purposes of residences, and will greatly damage and depreciate the value of the same.

#### PLAINTIFFS ALSO AVER

that the Duquesne Traction Company has made or is about to make an agreement and lease of some kind for the construction and operation of said passenger railway, and that Councils pretended to give by ordinance the right to enter upon said Negley avenue and make and construct thereon such motors, cables, electrical and other appliances, necessary and convenient mechanical fixtures, as said company may at any time select, and also to lease the property, right and franchises of said Craig Street Railway Company, and to construct and operate the railway of said company.

Plaintiffs also aver that a certain other corporation, named the Negley Avenue Passenger Street Railway Company, has been incorporated to lay a street railway along Negley avenue, between the streets aforesaid, and that its charter existed before and at the date of the incorporation of said defendant.

It is also averred that the act under which the Craig Street Railway Company is incorporated, forbids the construction of any railway incorporated thereunder within the limits of any city, etc., without the consent of the local authorities thereof, and that the city of Pittsburg has no authority to assent to or authorize any person or corporation to enter upon, use or occupy said street except such consent or authority be expressed by general ordinances, and that the said defendants do not possess the authority of the city expressed by general ordinance.

Also, that the act of May 14, 1889, under which the Craig Street Railway Company is incorporated, is unconstitutional, in that it does not provide a method or remedy whereby plaintiffs may compel defendants to secure compensation to them in advance; and also, that the act of 22d of March, 1887, under which the Duquesne Traction Company is incorporated, does not empower it to take property of plaintiffs to its use, or if it does, then that it is unconstitutional.

And finally that neither of said defendants have any right or power by virtue of their charters to construct and maintain a street railway over Negley avenue in the manner threatened by them.

#### THE QUESTIONS RAISED

by the bill, answer and affidavits, are all merged into one inquiry, to wit: Have defendants, or either of them, shown the legal right to construct, operate and maintain a railway on Negley avenue, as proposed by them?

This involves the proper interpretation of defendants' charters, the constitutionality of the acts under which they were granted, and the validity of the ordinances of the city of Pittsburg granting them the right to build and operate the road in question.

It cannot be doubted at this day that the legislature of Pennsylvania has the power to authorize the incorporation of companies with power to build and operate railways with horses, over the streets of cities, with the authority and consent of the authorities of said cities, as provided by section 9 of article 17 of the constitution.

And it is too late to say that such use and occupation of the street impose such an additional burden of servitude thereon as renders it necessary to provide for compensation therefor to the owners of abutting property. Nor can it be successfully urged that the proper municipal authorities may not, at their discretion, repair, improve and change the pavements put down by the city whenever it may be done without any additional cost or expense to the city or property owner, so far at least as it may be of a usual and ordinary character. The power over the streets vested in the city authorities seems to be absolute so long as its exercise is not inconsistent with their ordinary use and does not take, injure or destroy the property of adjoining owners.

#### RIGHTS OF THE CITY.

Therefore I do not think that the fact that the plaintiffs secured the paving of a street from the city for which they paid in the ordinary way, by assessment, took away any right the city had to repair or change the pavement or grade of the street, or to exercise over it the same power it has over any other street or alley in the city. There can be no doubt that under a proper charter the city had the right to allow the streets to be so used for a street railway, with horses as a motive power. So far as the street use proper is concerned, there is no substantial difference between the tracks of such a street railway and one operated by electricity. We may then assume that the occupation of the street with track, intermediate paving and the appliances in ordinary use for railways operated by horses, there is nothing of which plaintiffs can legally complain. Whatever dust, noise and annoyances is incident, they must submit to.

But there is a material and substantial difference between such a road and the one contemplated by defendants, as regards its relation to plaintiffs' property.

The proposed road not only occupies the middle portion of the street or cartway, but will, as a necessary part of its machinery, have iron posts some eighteen feet high, permanently fixed three or four feet in the ground along or near the curb of the pavement or sidewalk, upon which will be placed permanent lines of wire crossing the street, and upon which will also be placed a permanent wire over each track, swung longitudinally with the street.

Do these singly or altogether amount to such a taking of plaintiffs' property as is prohibited by the constitution without compensation?

The placing the wires over the street does not appear to be a taking of plaintiffs' property. The streets are dedicated to public use, and he has certain special rights as an abutting owner, but I cannot see how a wire run through

the air above the street can be said to be taking, or injuring or destroying his property. But

#### ANOTHER QUESTION ARISES

in reference to the posts placed in the ground for the support of the wires by means of which the cars are moved. It has generally been understood in Pennsylvania that the abutting owner had a fee to the middle of the adjoining street, and that the public only has a right of passage or easement over it. Chambers versus Furry, 1 Yeates 16. Lewis versus Jones, 1st Pa. St. 336. But this must not be taken in its literal sense, especially in towns and cities.

What might be considered an invasion of private right, so far as the use of a highway is concerned, might not be so in a city. Thus a city, by virtue of its general authority, may build sewers, and the adjoining proprietor is not entitled to have damages assessed, as for a new use or servitude. Fisher versus Harrisburg, 2d Grant 291; Cone versus Hartford, 28 Conn. 363; Traphagen versus Jersey City, 29 N. J. Eq. 206; Michener versus Philadelphia, 118 Pa. St. 535. In such case the street is not only used without compensation to the adjoining owner, but he is compelled to pay for the use of the sewer. So the right to lay down gas pipes in the streets as given by the Legislature to municipal authorities, without allowing compensation, has been recognized by the courts, and while it has not been expressly ruled in Pennsylvania that I know of, Judge Sterrett, in Sterling's appeal, while deciding that a gas line was an additional burden which entitled the owner to damages in the country, said: "As to the streets and alleys in cities and boroughs there are reasons why a different rule to some extent should prevail." Such has been taken as the law in cities by common consent. I do not think that any one ever heard of a suit in Pennsylvania to recover damages for injury done merely by running a gas pipe along the street in front of his premises under municipal authority. So with water pipes, awning posts, fire plugs and lamp posts. These all more or less infringe upon the alleged absolute right of an owner of the soil, and are not necessary to accommodate public travel, nor even consistent with the public right to an unobstructed passage way. And it may be now taken as settled that the owner's rights of abutting property are subject to the paramount rights of the public, and the rights of the public are not limited to a mere right of way, but extend to all beneficial legitimate street uses as the public may from time to time require.

#### UNDER MUNICIPAL CONTROL.

The use of the streets for sewers, tunneling, public cisterns, gas pipes, water pipes and other improvements necessary for the comfort and convenience of the citizens of cities and towns, so long as they do not substantially interfere with the use of the streets as such, appear to be under legislative and municipal control. Dillon on Municipal Corporations, section 699.

The case of Taggart versus The Newport Street Railway, decided this year by the Supreme Court of Rhode Island, is directly in point, and if good law, covers the case in hand.

My own impression is that the use of poles, wires and the other necessary appliances such as proposed being used by plaintiffs, is not in any respect a greater interference with the ownership of the adjoining property owners on a street than the use of streets for fire-plugs, horse-troughs and lamp-posts, which have long and generally been recognized as within the power and control of the city government.

Recognizing the right of the Legislature and city authorities to authorize the building of street railways upon streets of a city without compensation to property owners, because it is a means of public transportation and accommodation, the necessary and proper apparatus for moving them must be allowed to follow as an incident, unless there is something illegal in its construction or use. The proposed construction here is no more illegal by reason of its effect upon the owners of property, so far as actual interference with their rights to use the streets is concerned, than so many lamp-posts, and if compensation could not be compelled for the ground taken by them, neither should it be for the posts supporting the wires in this case.

Thus far I have assumed that the charters of defendants gave the right to defendants to exercise the powers to construct, maintain and operate a street railway on Negley avenue. But plaintiff's counsel lay great stress upon the point that under the acts of Assembly cited defendants have no right to build or operate a road, because no power is conferred thereby to do so. His argument is that no such power is expressly given by the act of 1889, and can not be implied. But with this I am

#### UNABLE TO CONCUR.

The act of 14th May, 1889, is entitled an act for the incorporation and government of street railways in this Commonwealth, and provides "that any number of persons not less than five may form a company for the purpose of constructing, maintaining and operating a street railway on any street or highway upon which no track is laid or authorized to be laid, etc., with the privilege of occupying so much of the street used or authorized to be used by any existing charter, as is hereinafter provided, for public use in the conveyance of passengers by any other power than by locomotives."

This leaving out restricted matter of location would read: "A company may be formed for the purpose of constructing, etc., a street railroad for public use in the conveyance of passengers by any other power than by locomotive." The method of forming such company is there provided, and when incorporated it was to have the power and privilege of succession; to sue and be sued; make and use a seal and hold real and personal estate. Section 15 provides no street passenger railway shall be incorporated under this act within the limits of a city without consent of the local authorities, etc.

Section 16 requires the construction, etc., to be commenced within one year after the consent of the proper local authorities, etc.



It is true that the act does not say the corporation shall have the right to build, maintain and operate a railroad, but it does say a company may be formed under the provisions of the act for that purpose, and to suppose the Legislature authorized a company to be formed for specific purpose and then say when formed it had no power to carry out the purposes of its creation, because they did not declare in so many words that they should have the power to do, the very purpose for which it was created, is a refinement of interpretation I do not think warranted by either reason or authority.

#### DEFENDANTS' RIGHT TO PROCEED.

To my mind the power in the Craig Street Railway Company to construct and maintain a railroad on compliance with the terms of the act under which it is incorporated is clear, and that the defendants have shown a legal right to proceed and construct the railway contemplated by them unless the failure to provide means by which the plaintiff may have such damages as they may sustain assessed and paid or secured in advance renders the act unconstitutional. Upon this question I am not free from doubt, but the decided inclination of my mind is that the act is not unconstitutional for that reason, because the use of the streets for the purpose of applying motive power in the manner proposed is not such a new use as in cities should be treated as outside the proper purpose for which streets will be held to have been originally dedicated to the public use. *Taggart versus Newport Railway Company* before cited is exactly in point. The case presented by plaintiffs is certainly not so clear from doubt that a Chancellor should grant any injunction summarily stopping a great public improvement before final hearing, more particularly because if the position taken by plaintiffs is correct and defendants have no legal right to take possession of the street as they are about to do, a common law action will compel them to pay all damages arising to plaintiffs, and thereafter equity would probably afford a complete remedy by which the wrong done them could be fully corrected.

Injunction prayed for is now refused.

BY THE COURT.

### State Railway Commissioners' Decision.

#### *In re Troy & Lansingburgh St. Ry. Co.*

ALBANY, N. Y., July 8, 1890.—This application, dated June 17, 1890, was duly lodged with the board. A public hearing was had at the office of the board in Albany July 7, after due notice thereof in the newspapers of the city of Troy. The railroad company was represented by Charles Clemminshaw, president; Gen. Joseph B. Carr and Hon. L. E. Griffith, counsel. A pro forma opposition was presented on behalf of the Commercial Telephone Company of Troy by William Shaw, counsel. It appears that negotiations are pending between the telephone company and the railroad company to so modify the construction of the wires of the respective companies as to prevent the interference with the currents of the telephone company by the railroad company. This board will, therefore, not discuss this subject further, but refers to its decision in the matter of the application of the Troy and Lansingburgh Railroad Company on its own behalf and as lessee of the railroads of the Waterford and Cohoes Railroad Company, etc., rendered Oct. 28, 1889 (R. R. Com. R. 1889, vol. 1, pages 123-126). Phillip Wagner also appeared with a request to withdraw his consent as owner of abutting property to the amount of \$18,000. Mr. Griffith, on behalf of the company, presented the consent of the local authorities to the proposed change, as embodied in a resolution of the Common Council of June 25, 1889, and also the affidavit of Edward Carter, General Assessor, showing the consents of abutting property-holders to the amount of \$4,519,613, out of a total of \$7,974,596 assessed value of abutting property.

In view of the above facts the board deems it is justified in approving, and does hereby approve, of a change of motive power from horses to the overhead single-trolley system by the Troy and Lansingburgh Railroad Company upon that portion of its railroad in the city of Troy from the northern boundary line of said city to the southern terminus of said railroad, with the following conditions, however, which are made part of this approval: First, the requirements of the city ordinance hereinbefore alluded to, passed June 25, 1889, shall be conformed to in all respects. Second, the rate of speed shall not exceed that to be definitely fixed by the Mayor and Common Council of the city of Troy. Third, the poles from which the wires shall be suspended shall be of a construction and height appropriate to the streets upon which they are to be erected, so as to impair the use and appearance thereof to the least possible extent, and before erection shall be approved by the city authorities. Fourth, no car shall be run with less than two men to operate it if run alone; if two cars are coupled together there shall not be less than three men for the two cars. Fifth, the company shall take all reasonable and proper means to prevent the currents from its wires, through leakage, induction or otherwise, from interfering with the currents upon the wires of other companies, whether telegraph, telephone or otherwise; this provision, however, is not intended to require the railroad company to construct a double trolley wire. Sixth, the company shall equip its cars with safety guards in front of the wheels, said guards to come within an inch of the ground so as to prevent persons being run over. By the board,

[Signed]

WILLIAM C. HUDSON, Secretary.

Mr. Clemminshaw is certainly to be congratulated upon this decision of the State railway commissioners; inasmuch as he has had a long fight in order to gain his point, and the pluck and persistence with which he carried the fight, certainly merited the success he attained.

## LEGAL DECISIONS.

### COURTS OF LAST APPEAL.

CONTRIBUTORY NEGLIGENCE—EVIDENCE AS TO WEATHER AND CONDITION OF TRACKS—*Silberstein v. Houston, West Street and Patonia Ferry Railroad Company*; Court of Appeals of New York, November 26, 1889, 22 N. E. Rep. 951.

PECKHAM, J. The motion for a new trial on the ground of the contributory negligence of the plaintiff was, we think, properly denied. It was a case, upon the whole evidence on that point, for the jury. The defendant did not claim that no case for a jury had been made out upon the question of the defendant's negligence. This would lead to an affirmance of the judgment but for the admission of one piece of evidence, which we think was erroneously admitted, and may have done great harm upon the question of defendant's negligence.

An officer of the weather bureau was called on the part of the plaintiff, and he had with him the official reports of such bureau, and which he swore were correct, and taken from observations made in the city of New York. The accident occurred on the 13th of February, 1887, and the witness was asked this question: "After looking at the reports, can you state when next preceding the 13th day of February, 1887, there was last a fall of rain or snow in the city of New York?" This was objected to generally by the defendant's counsel; no particular ground of objection being stated. Plaintiff's counsel then stated as follows: "We desire to show that it had not rained or snowed within two days, at least, of the 13th of February, and that there was still ice upon the stones between the rails of defendant's tracks at the point at which the boy slipped; and we desire to impute negligence to the defendant by reason of that condition of the track." The objection was thereupon overruled, and an exception taken, and the evidence was admitted; the witness testifying that on February 11, 1887, it rained from 2:50 P. M. to 4:40 P. M., and that was the first rain preceding February 13th. He further stated that the condition of the atmosphere on that day after the rain, at 10 o'clock P. M., was 44, and that there was no fall of rain or snow from the time stated on the 11th of February up to the 13th. At the time this evidence was admitted, it had appeared by undisputed proof that the streets were in some portions icy and slippery, and that the portion of the street in question at the place of the accident was in that condition. The purpose of the evidence on the part of the plaintiff's counsel was avowed, and that purpose was brought out as an answer to the objection of the defendant's counsel to the introduction of such evidence. It was to impute negligence to the defendant by reason of the condition of the tracks, or, in other words, because of the existence of ice between the rails in a public street of a city. The idea, seemingly, was that a duty rested upon the defendant to keep the space between its tracks free from ice and snow. Of course, no such duty rested upon it, and no such liability for a failure to do so as was claimed in this case would follow. It is now argued that if the evidence were admissible for any purpose, as there was simply a general objection to it, it was properly admitted, although plaintiff's counsel may have claimed its admission at the time upon improper grounds; and the case of *Parsons v. Railroad Co.*, 113 N. Y. 355, 21 N. E. Rep. 145, is cited to sustain such contention. The two cases, we think, are not precisely similar; but, however that may be, the difficulty with this evidence is that it was not admissible for any purpose. It is claimed that it was competent for the plaintiff to prove the condition of the street between the rails at the time the boy fell upon the track, because that fact had a tendency to explain the reason of his fall. It may be assumed that it was thus competent, for the reason alleged. But the evidence proposed, and taken under objection, had no tendency whatever to prove such condition. That condition had already been proved, was uncontradicted, and was really not a point in issue in the case. It is difficult to see how the condition of the street at the point where the boy fell could be proved by evidence showing that there had been no storm for two days before that time. It was only pertinent when taken in connection with the other

evidence as to what the condition of the street was, and in that way claiming to show neglect on the part of the defendant, in allowing the street to remain in that condition for such a length of time. We think this evidence could have been used, and judging from the record, very probably was used, before the jury with great effect upon the question of the defendant's liability. The charge is not given; and, judging only from the record as it appears before us, we can not assume that the error in the admission of the evidence was cured by the charge. We think the judgment should be reversed, and a new trial granted; costs to abide event.

THE USE OF ELECTRICITY ON STREET RAILROADS.—*Taggart v. Newport Street Railway Co.*; Supreme Court of Rhode Island. 19 At. Rep. 326.

The bill in this case sought to enjoin defendant from operating a railway by electricity along the streets of Newport. The court say:—"The street railway here complained of is operated neither by steam nor horse power, but by electricity. It does not appear, however, that it occupies the streets or highways any more exclusively than if it were operated by horse power. The answer avers that 'electricity, besides being as safe and as easily managed as horse power for the propulsion of street cars, is more quiet, more cleanly, and more convenient than horses, both for residents on the streets used by said cars, and for the public generally, and also causes much less wear and injury to the streets and highways than is occasioned by street cars of which horses are the motive power.' These averments, the case being heard on bill and answer, must be taken as true. We see no reason to doubt their truth. It is urged that electricity is a very dangerous force, and that the court will take judicial notice of its dangerousness. The court will take judicial notice that electricity, developed to some high degree of intensity, is exceedingly dangerous, and even fatally so, to men or animals, when it is brought in contact with them; but the court has no judicial knowledge that, as used by the defendant company, it is dangerous. The answer denies that it is dangerous to either life or property. It is also urged that the cars, moving apparently without the application of external force, alarm and frighten horses. This, so far as it is alleged in the bill, is denied in the answer. We see no reason to suppose that this form of danger is so great that on account of it the railway should be regarded as an additional servitude. The answer alleges that a great many street railways operated by electricity, in the same manner as the railway of the defendant is operated, are in use in various towns and cities in different states, and that many others are in process of construction. Reference has been made to cases which hold that telegraph or telephone poles and wires erected on streets or highways constitute an additional servitude, entitling the owners of the fee to additional compensation; and from these cases it is urged that increase the safety and efficiency thereof, does not constitute an additional servitude, but is only a legitimate development of the easement originally acquired. *Telegraph Co. v. Rich*, 19 Kan., 517. Our conclusion is that the complainants are not entitled to the relief prayed for on the ground alleged, and that the bill be dismissed with costs."

ACCEPTANCE OF ORDINANCE BY COMPANY.—*City of Trenton v. Trenton Horse Railway Co.*; Court of Chancery of New Jersey, January 10, 1890. 19 At. Rep. 262.

The Court say:—"The acceptance by a street railway company of a city ordinance authorizing it to extend its line, is not rendered insufficient by a declaration in the instrument of acceptance, that it waives none of its vested rights under its charter. But where the consent of the council and the street committee to the prosecution of the work of such extension has been given, and it appears that the only location for the line is the extension of a track which has been laid for years on the same street, the company will not be restrained from carrying on the work because the street committee has not, in its official capacity, defined and authorized the exact location of the track."



## STREET RAILWAY NEWS.

## DOMESTIC.

See also "New Enterprises," "Extensions," "Elections," etc.

The following data is compiled with all possible care, but the publishers, receiving news as they do, from almost every state, territory and country, cannot be held responsible for errors, as it would be wholly impossible to obtain a verification of each item received by them in time for each issue.

## ALABAMA.

**Clarksville**—A dummy line is badly needed from this point to Dunbar's Cave, a distance of two and a half miles, and Mr. P. S. Barber, the owner of the cave, has offered to donate \$10,000 to any corporation that will construct a rapid transit line between the two points indicated. Should any one take hold of this project the citizens will swell the subscription considerably.

**Opelika**—While the construction of a dummy line from this point to Albany is not yet an accomplished fact, but little doubt exists that the line will be shortly built.

## CALIFORNIA.

**San Francisco**—We understand that Mr. John McCord, formerly superintendent of the Center Street Cable Road, has resigned his position. Upon his resignation being accepted he was presented with a magnificent gold watch by his employees as a token of their respect for him.

It is yet uncertain as to who will be Mr. McCord's successor, but indications point to Mr. John Reynolds, formerly superintendent of the Geary Street Road.

## CONNECTICUT.

**Norwich**—The scheme to introduce electric street cars here has fallen through.

## DISTRICT OF COLUMBIA.

**Washington**—At the annual meeting of the Anacostia and Potomac Ry. Street Railway Company President Griswold made his annual report, which showed the road to be in first-class financial condition. A number of new double-platform cars have been ordered from J. M. Jones' Sons Co., of West Troy, N. Y.

## DELAWARE.

**Wilmington**—The annual meeting of the stockholders of the Wilmington City Passenger Railway Company was held on the 15th ult., when the annual report of the finance committee was read and adopted. A list of the officers and directors of the company will be found under the head of "Elections" in the present issue.

## GEORGIA.

**Athens**—It is highly probable that this city will soon be traversed by a belt line of electric railway.

**Savannah**—It is highly probable that this city will soon have electric cars in operation.

## INDIANA.

**Columbus**—Messrs. Scott and Lyle, of Louisville, have secured the contract for the construction of four miles of road here, the work of which is to be commenced at once, and must be completed by the 1st of October. Horses will be used at first, but Mr. John S. Crump, who owns the charter, says that electricity will be adopted before very long.

## IOWA.

**Davenport**—We understand that an Eastern syndicate has made an offer for all the street car lines here, as well as in Rock Island and Moline, but the officers of the roads claim that their lines are not for sale.

**Dubuque**—The Dubuque Street Railway Company, of which Mr. Rhomberg is President, has applied for an electric light franchise.

The Dubuque Street Railway Company has filed several important amendments of articles of corporation; such amendments provide that the motive power used on the road may be animal, steam, electricity or hot air, and the capital stock of the company is increased to \$300,000.

## KENTUCKY.

**Louisville**—As predicted in a former number of the GAZETTE, the entire street car system of this place, aggregating about 151 miles and more, has now passed into the hands of a syndicate in consideration of the sum of \$4,000,000, of which the first payment of \$80,000 was made on June 10th. The syndicate is composed of E. E. Den-

niston and E. W. Parker, of Philadelphia; J. V. W. Seligman Co., Kidder, Peabody & Co. and Brown Bros., of New York. The stock was sold at \$272 per share.

## MASSACHUSETTS.

**Boston**—The West End Company will probably lay new tracks in Centerville.

**Lawrence**—The first meeting of the new stockholders of the Merrimac Valley Horse Railway Company was held on the 26th of June, when the board of directors was increased in number from five to seven. The board was also authorized to petition the railway commissioners for an increase of the capital stock of the company from \$80,000 to \$300,000, and to issue \$80,000 in first mortgage bonds. The question of the adoption of electric power came up but was not decided upon.

**Pittsfield**—At the recent meeting of the directors of the Pittsfield Railway Company it was decided to dispose of the road to a syndicate for \$17,000. The new company will be capitalized at \$35,000, the shareholders of the old company having the privilege of taking stock in the new in proportion to the old stock held.

**Springfield**—The scheme of building a road in Westfield, as outlined some time ago in the GAZETTE, has taken definite shape, and the line will run from the depot to the foot of Pine Hill.

## MICHIGAN.

**Bay City**—Mr. Harry Rowlings, bookkeeper for the Street Railway Company, has disappeared, and his whereabouts are not known to his friends here. So far as can be ascertained his accounts are perfectly straight. Mr. Rowlings has been in poor health for some time.

**Detroit**—The City Railway Company has been incorporated to equip its Cass and Third avenue line with underground wires for the operation of its cars by electricity.

**Grand Rapids**—The Grand Rapids Street Railway Company has decided to equip its lines with electricity at once.

**Kalamazoo**—The foreclosure suit against the Kalamazoo St. Ry. Co. in the sum of \$100,000 with a bonded interest of \$10,000 more is in progress. The road was sold last May for \$42,550 to Wayne Griswold, Walter Staunton and N. Motley, trustees for the bondholders. The line is 6 miles long and the builders intend to extend it and put it in first class condition.

**Lansing**—The Lansing St. Ry. Co. has purchased \$50,000 worth of real estate in the southern part of the city, through which the St. Car line will be extended.

## MISSOURI.

**St. Joseph**—We understand that the Wyatt Park Ry. has been leased to the People's St. Ry. Co., thus giving the People's Co. control of the entire St. Ry. system here.

## NEBRASKA.

**Omaha**—The N. Western St. Ry. Co. in which C. F. Goodman, Walker Goodman, H. G. Penfield, Hiram G. and Joseph Bell are interested, have filed amended articles of corporation, and Mr. Goodman says that the company is now figuring on commencing work on the road at once.

## NEW JERSEY.

**Elizabeth**—All the Elizabeth roads have now consolidated under the name of the Elizabeth Pass. Ry. Co., and a list of the directors will be found under the head of the elections in the present issue.

**Long Branch**—The project of an electric Ry. between this point and Red Bank by way of Eatontown has not yet been perfected. It is thought, however, that the line will be built.

**Newark**—The Newark and S. Orange Ry. Co. has been purchased by a syndicate of which Mr. S. B. White of N. Y. is at the head. We understand that the price paid was something like \$1,600,000.

By the consolidation of the Essex Pass. Ry. Co., and the Hudson and Bergen Point Horse Ry. Co., previously mentioned in the GAZETTE, the old Essex Pass. Ry. Co. is done away with, and the name of the new corporation which now embraces all the St. Ry. lines in Newark is the Newark Pass. Ry. Co.

## NEW YORK.

**Amsterdam**—The purchase of the Amsterdam Street Railway Company by the Philadelphia

syndicate has been completed, and the road will now be converted into an electric one. Work has already commenced, and it is expected that the line will be in operation by September. Something in the neighborhood of \$250,000 will be expended in the new equipment and new improvements. James R. Snell has been retained as superintendent.

**Brooklyn**—The Coney Island & Brooklyn Railroad Company has made application for permission to change its motive power to electricity.

The syndicate that is to build a surface road to Montague street here will adopt either cable or electricity as a motive power, and has been experimenting with a new storage battery, the patents of which are controlled by S. B. Chittenden.

The Brooklyn City Street Railway Company has mortgaged all its franchises and property to the Mercantile Trust Company, of New York. The mortgage is in 2,000 bonds of \$2,000 each, paying 5 per cent. per annum. The Mercantile Trust Company will hold \$9,000 of the bonds, to be disposed of in paying off existing mortgage bonds, and the Railroad Company will receive \$1,000,000 of bonds to introduce electricity.

**New York City**—The annual report of the Eighth Avenue Railway Company shows the gross earnings for the past fiscal year to be \$200,477, as against \$180,444 the previous year; operating expenses were reduced from \$126,265 to \$125,624. After deducting taxes, interests, etc., a net income of \$54,316 is left, as against \$32,790 during 1888 and 1889. The report of the Ninth Avenue Railway Company shows that during the past fiscal year the gross earnings were \$69,846, as against \$55,511 for 1888 and 1889. The operating expenses were increased from \$34,740 to \$48,619. After deducting taxes, rentals, interest, etc., the net income is found to be \$16,482, as against \$8,279 for the preceding year. The deficient account has been reduced from \$149,906 to \$249,268.

**Troy**—The Troy and Albia Horse Railway Company has petitioned for an electric franchise.

## OREGON.

**Oregon City**—The Oregon City Street Railway Company is taking steps for the immediate construction of an electric railway, to run from the bridge to the resident part of the city.

**Portland**—On June 30th a fire occurred at the stables of the Willamette Bridge Street Railway Company. The building was burned to the ground, but all the horses—43 in number—were saved, as also a majority of the carriages and buggies. About \$7,000 worth of horse cars were destroyed. The total loss probably reaches in the neighborhood of \$20,000, upon which the street railway company has an insurance of about \$10,000.

## PENNSYLVANIA.

**McKeesport**—We understand that the capital stock of the McKeesport Passenger Railway Company will at once be increased from \$36,000 to \$100,000, in order to provide for extensions and improvements on the road.

**Philadelphia**—The report of the Ridge Avenue Street Railway Company, for its fiscal year, which ended June 30th, shows that during the year 7,280,743 passengers were carried; that the receipts of the road were \$361,528, as against expenses of \$207,051, leaving the sum of \$150,000 to be distributed among the stockholders in dividends.

**Pittsburgh**—At a recent meeting of the stockholders of the Street Car Company it was decided to increase from \$250,000 to \$3,000,000. During the six months last past the receipts from passenger traffic aggregate \$281,000, net \$65.35, with net profit of \$88,444.35.

Some time ago Wm. Gobering, J. N. Stewart, T. H. McLean and others secured a charter for a car line along the river road to Homestead. The charter was secured for the purpose of building a horse road along the route, but the success of the electric system all over the city calls the incorporators to give up the original idea, and the South Side Electric Street Railway Company has now purchased all the rights and privileges of the former company, and will commence operations on the new line in the immediate future.



Joshua Rhodes, H. S. A. Stewart, Jas. Pattison, Jr., S. P. Connor and others are interested in the new company.

#### RHODE ISLAND.

**Newport**—The executive committee of the New Improvement Association has decided to raise \$30,000 for the proposed new route of electric cars to the bathing house, \$20,000 of which is to be paid to the Street Railway Company for the expense of changing its tracks, and \$10,000 to the city on account of its having to lay out the new road.

#### SOUTH CAROLINA.

**Orangeburg**—The Orangeburg Street Railway Company has been leased for two years to J. W. Dukes, who has been president and general manager of the road for the past year. He is to pay, by way of rental, 8 per cent. per annum upon the stock.

**Winston-Salem**—Last month the first street car ever operated here was started by President Sprague, of the Local Street Car Company. Mr. Sprague's father was aboard, as also were Secretary J. H. McClemment, Mr. Field, of the Field Engineers Company, N. Y., Mr. Bourn, of the Salem Electric Railway and Montau Company of New York, and the representative of the STREET RAILWAY GAZETTE, together with a number of the citizens of Winston and Salem. Everything worked to perfection, as might be expected, and considerable enthusiasm was shown by the Winstonites.

#### WISCONSIN.

**Appleton**—The Appleton Electric Street Railway Company has been sold to the Appleton Edison Light Company, which, we understand, will equip it with electricity at once upon the Sprague system.

**Racine**—Mr. Chas. Hathaway, of Cleveland, O., principal owner of the Belle City Street Railway Company, is authority for the statement that his line here will not be electrically equipped during the present year.

## NEW ENTERPRISES.

#### CONNECTICUT.

**Ellington**—A project is on foot for the construction of a horse railway between this point and Rockville.

**Hartford**—It is highly probable that the Hartford and Wethersfield Horse Railway Company will be extended from its present terminus in East Hartford to Glastonbury.

We also understand that residents below Welles' Corner are anxious to get an extension of the road to South Glastonbury next year, and subscriptions for the furthering of the project have already been made.

#### FLORIDA.

**Pensacola**—The right of way over the streets of the city for a belt line has been granted by the city commissioners.

#### GEORGIA.

**Gainesville**—The Gainesville Street Railway and Sulphur Springs Company have made applications for a charter.

#### ILLINOIS.

**Cairo**—The council has granted a right of way to the Cairo Electric Ry. Company over five miles of street. By the conditions of the grant the new company is to commence work within ninety days and have the road in operation within a year. The company is capitalized at \$150,000, and is composed of a number of St. Louis gentlemen, among whom may be mentioned J. R. Turndale and R. M. Foster. Work is to be commenced at once, and pushed forward to completion without delay. We also understand that the Cairo Street Railway Company is taking steps to change its motive power to electricity.

#### INDIANA.

**Knightstown**—A movement is on foot for the construction of a street railway between the Sailors' and Soldiers' Orphans' Home and the city. Eastern capitalists are interested.

#### MASSACHUSETTS.

**Attleboro**—The Attleboro, Norton & Pawtucket Railway Company has been organized, with a capital stock of \$100,000.

**Lynn**—The project of building an electric line

from West Lynn across the marshes and Sorgus river to the Point of Pines is still in abeyance, but it looks very much as though the road will be built.

**North Abingdon**—The Hathaway Street Railway Company has been organized, with a capital stock of \$100,000. A list of the directors will be found under the head of "Elections" in the present issue.

#### MISSOURI.

**Springfield**—The Wabash Street Railway Company has been incorporated, with a capital stock of \$400,000. The incorporators are Robert J. McElhany, Robert L. McElhany and Martin J. Hubble.

#### NEW HAMPSHIRE.

**Middletown**—The citizens here are considering the subject of securing an electric street railway.

#### NEW JERSEY.

**Asbury Park**—The Ocean Grove & Shark River Street Railway Company has been incorporated, with a capital stock of \$75,000, for the purpose of building a line from here to Belmont, a distance of two miles. The incorporators of the company are Howard C. Chandler, of Philadelphia; W. L. G. Thomas, of Wilmington, Del.; James Middledith, of Plainfield, N. J.; Edward Fieldham, Ocean Grove; Daniel W. Siston, James N. Gordemas and John Wood, of Asbury Park.

**Hoboken**—The Hudson River Railway Company, which owns the Hudson Electric Railroad, is about to build a new road from the foundry in Hoboken to West Hudson. Certain portions of the road will, it is understood, be elevated.

**Newark**—The Newark Bay Railway Company has been incorporated, with a capital stock of \$56,000.

#### NEW YORK.

**Albany**—An electric railway to the lake, reference to which has been made in a former issue of the GAZETTE, will undoubtedly be built, and the line will start from Owasco and Tennessee streets, proceeding up the former as far as the lake shore, at which terminus there will be a pleasure park, etc. A list of the officers, etc., will be found under the head of "Elections" in this issue.

**Glenwood**—A movement is on foot to establish a dummy line from this point to the shore, and the scheme is meeting with considerable favor. We understand that S. S. Conover, of New York, and Mr. R. H. Montgomery are financially interested in the scheme.

**Lyons**—An electric railway is projected between here and Sodus Point.

**Utica**—Several Utica capitalists are discussing the project of another electric railway from Washington Mills to this point, to connect with the Oneida Street Railway.

#### ONTARIO.

**Ottawa**—W. H. Howland, of Toronto, has made a proposition to the city council to construct an electric railway here. The company is to be stocked at \$250,000, one-fifth of which is to be held by the citizens.

#### OREGON.

**Union**—J. W. Sheldon, acting as trustee, recently presented an ordinance to the city council asking for a franchise to build and operate a street railway through the streets here.

**Whitcomb**—We understand that Mr. Cornwall and others have secured a franchise for an electric road. Said road is to be in operation within the next four months.

#### PENNSYLVANIA.

**Braddock**—The Park Passenger Railway Company has presented an ordinance to the council to consider the application for right of way through the borough.

**Kittanning**—We understand that a project is on foot for the construction of an electric railway from this point to Ford City. Capt. Ford, Capt. J. D. Henry, Secretary C. C. Jessop, A. C. Bailey and Dr. S. A. Jessop are interested. It is believed that the road, when built, will run directly through Manorville.

**McKeesport**—A company has been organized to run an electric railway from this point to Six-Mile Ferry.

**Pittsburgh**—The Pittsburgh Street Railway Company, capitalized at \$30,000, has been incorporated.

The Wilkins Street Railway Company, of this city, capitalized at \$6,000, has been incorporated.

**Whitting Station**—An electric railway will probably be built from this point to Whitting Station.

#### SOUTH DAKOTA.

**Huron**—William T. Love and others have been granted a franchise for the construction of an electric railway here, work on which will be commenced as soon as the preliminaries are completed.

#### TEXAS.

**Dallas**—The Cable Construction Company which was organized to construct a cable railway, has now been incorporated, with a capital stock of \$50,000. The incorporators are J. M. Harry, Thomas Field, Frank Field, Charles W. Guild, Als. Childers, Thomas R. Crawford, W. H. Prader, C. E. Kelley, C. H. Cooper, T. J. Wolf and J. L. Thompson.

The Dallas Cable Railway Company, capitalized at \$600,000, has been incorporated by the same gentlemen who incorporated the Cable Construction Company.

**Houston**—The Houston & Covington Street Railway Company, capitalized at \$10,000, has been incorporated by James T. Dinwood, O. R. Grover, D. W. Drolen, B. Kime, D. Kora and B. Van Foster.

#### UTAH.

**Bountiful**—Messrs. Bamberger, Hamilton Hermanhil, M. R. Evans and others are interested in a project for the construction of a street railway between this point and Warm Springs, a distance of eight miles.

#### VERMONT.

**Bristol**—The contract for the construction of the Bristol Railway has been awarded to George A. Hyer, of St. Albans, Vt.

#### VIRGINIA.

**Norfolk**—At a recent meeting of the directors of the Hampton & Norfolk Street Railway Company it was decided to commence building a road between Hampton and Norfolk at once. Electricity will probably be adopted.

#### WASHINGTON.

**Spokane Falls**—The Arlington Heights Street Railway Company, of this city, capitalized at \$50,000, has been incorporated.

**Yakima**—The Yakima Street Railway and Power Company has been incorporated to construct an electric road three miles in length. The capital stock of the company is \$100,000.

#### WISCONSIN.

**Milwaukee**—The Milwaukee & Wauwatosa Electric Railway Company, of this city, has filed articles of incorporation, with capital stock of \$100,000. The incorporators of the company are Daniel Wells Jr., Jerome R. Brigham and Horris Upham.

## ELECTIONS.

**Wilmington, Del.**—At the annual meeting of the stockholders of the Wilmington City Ry. Co., Mr. Wm. Canby was elected president, and Mr. John F. Miller Sec'y and Treas. Directors, Mr. Wm. Canby, Geo. Bush, Geo. H. Bates, Washington Jones, Dan'l W. Taylor, Preston Mea, Chas. Howland.

**Washington, D. C.**—At the recent meeting of the Anacostia and Potomac River St. Ry. Co., the old board of directors was re-elected as follows: Messrs. Clark, Chrystie, Griswold, Hally, McCaully, Smithson and Williams.

**Rockland, Mass.**—The following named gentlemen constitute the board of directors of the recently incorporated Hathaway St. Ry. Co. Albert Culvin, L. T. Wright, J. T. Richmond, Moses W. R. Lowe, Louis E. Cook, Geo. O. Jacobs and Lot Phillips. Geo. W. Kelley was chosen president and E. P. Reed, treasurer.

**N. Abingdon, Mass.**—At the annual meeting of the stockholders of the Hathaway St. Ry. Co., the following named gentlemen were elected as officers and directors of the company: Directors, Geo. O. Jenkins D. T. Richmond, M. N. Arnold, E. T. Wright, Albert Culver, Lot Phillips, Louis N. Cook, Geo. W. Kelley. Mr. E. P. Reed was made treasurer.



**Lawrence, Mass.**—At the first meeting of the new stockholders of the Merrimac Valley Horse Ry. Co., the names of Albert D. Bowman and Chas. E. Legg of Gilsey were added to the board.

**Grand Rapids, Mich.**—At the annual meeting of the Grand Rapids St. Ry. Co., Geo. R. Penney was elected president and treasurer in place of Prof. G. C. Swingsburg. Mr. B. S. Hunchore was elected secretary.

**Elizabeth, N. J.**—The following named gentlemen constitute the board of directors of the newly organized Elizabeth Pass. Ry. Co.: Frank Bergen, Henry C. Moore, John A. Ackerman, Amos Clark Jr. and Henry Congar. The president of the road is Mr. Frank Bergen with Mr. John A. Ackerman as secretary and treasurer.

**Albany, N. Y.**—The officers of the new Elec. Ry. Co. here are as follows: Prest. David D. Gould; V. P., Gorton W. Legg; Treas. E. T. Storke, Sec'y, A. H. Andrews.

**Brooklyn N. Y.**—At the first meeting of the stockholders of the Brooklyn Heights Road, recently incorporated, the following named gentlemen were duly elected as directors: John W. Wilson, S. D. Leverick, Wm. Maddock, Hy. J. Kullen, Jr., Dan'l F. Lewis, Horace J. Morse, Jacob D. Ditmer, John Cells, Jr. Howard Smith, Jno. B. Fairchild, George S. Studwell, Edward Johnson, S. C. Smith. At the subsequent meeting of the directors the following members were elected as officers of the company: Prest. Dan'l F. Lewis; V. P., Jno. E. Sells, Jr.; Treas., Geo. E. Studwell; Sec'y, Edward Johnson. The executive committee—Messrs. Lewis, Studwell, Morse and Smith.

**New York, N. Y.**—At the annual meeting of the North River Ry. Co., which was held in New York on the 9th ult., the following named gentlemen were elected as directors: Anson Raymond, Chas. Leonard, M. J. Dady, Robt. Averly, Thos. F. Carling, A. J. Hutchinson, E. F. McLaughlin, A. W. Child, F. W. Child, Stewart McDougal, N. I. Smith, Homer A. Nelson and Wm. H. Delaney.

**Portland, N. Y.**—At the annual meeting of the directors of the Courtlandt and Homer St. Ry. Co., Mr. Chas. Garretson of Troy was elected president, and S. E. Welsh, secretary and treasurer.

**Pittsburg, Pa.**—The board of directors of the Wilkins St. Ry. Co. is composed as follows: John W. Willard, John T. Boyd, James C. Duffey, Wm. C. Chicoak and Robt. S. Frazer.

**Burlington, Vt.**—At the annual meeting of the Wasiooston & Burlington Horse Ry. Co. the following named gentleman were duly elected for the officers and directors for the ensuing year: Prest., Elias Wyman, V. P., J. T. Hench, Treas. J. H. Turner, Clerk, F. D. Traffic, Supt. K. B. Walker, Asst. Supt. Jos. Lynch. Directors, L. H. Turk, Elias Wyman, Geo. F. Thorp, J. B. Hatch and A. Richardson.

**Seattle, Wash.**—At the annual meeting of the stockholders of the Front St. Cable Ry. the old board of trustees was re-elected; at a subsequent meeting of old trustees, the following named officers were elected for the ensuing year: President, A. B. Storey, A. P. Mitten, secretary, Ellis McMicken, treasurer, David Furth, supt.

**Oshkosh, Wis.**—At the annual meeting of the Oshkosh St. Ry. Co., the following gentlemen were elected as officers: President, Chas. Barber, V. P., J. H. Porter, Sec'y and Treas. J. H. Jenkins, Supt. C. E. Montgomery; Directors, Chas. Barber, J. H. Porter, Marshall Harris, Chas. Scriber and J. H. Jenkins.

## EXTENSIONS.

**Newburyport, Mass.**—We understand that the High St. Road will be extended to Parker River Bridge in the near future.

**Dover, N. H.**—It is expected that the Dover and Great Falls Electric Ry. will soon be extended as far as Rochester.

**Ballston, N. Y.**—It is generally understood that the extension of the Saratoga Elec. Ry. to this point will be commenced at once.

**Binghamton, N. Y.**—We understand that the Elec. Ry. is to be considerably extended in the future.

**Lansing, Mich.**—The Lansing St. Ry. Co. will extend its electrical system at once (vide "News").

**Rochester, N. Y.**—A meeting of the directors of the Rochester Ry. Co. was recently held, at which Mr. Sidney H. Short, Prest. of the Short Elec. Ry. Co., Cleveland, O.; O. E. Peckham, Prest. of the Car, Wheel & Axle Co., of New York City, and Major Harry E. Evans of Johnson Co., Johnstown, Pa., were present—each of the companies represented by these gentlemen having contracts with the Ry. Co. for a portion of the work to be performed—it was decided to extend the Plymouth Ave. line; the South Ave. line will probably be extended in the immediate future.

**Reading, Pa.**—The 11th St. branch of the City Pass. Ry. Co., is being extended a distance of about six blocks.

**Seattle, Wash.**—The Front St. Cable Ry. Co. has ordered material for the construction of its proposed extension down Commercial St. to Crig Street.

**Staunton, Va.**—The City St. Ry. Co. will extend its lines beyond the corporate limits at once.

**Washington, D. C.**—The work of extension from the end and 11th St. junction of the Anacostia and Potomac River St. Ry. Co. is being rapidly pushed forward and it is expected that the road will be finished and in operation by the 15th of September.

## TRAMWAY NEWS

### FOREIGN.

#### AUSTRIA.

**Vienna**—The Wiener Dampf Tramway Gesellschaft places its earnings in 1889 at 294,404 gulden.

The Wiener Tramway Gesellschaft celebrated its 25th anniversary on June 16, 1889, amidst the general rejoicings of the officers and employes.

The Petroleummotoren Tramway has been opened for business. As its name indicates, petroleum will be used as fuel.

The Wiener Dampf Tramway Gesellschaft has projected four new tramway lines at an estimated cost of 1,200,000 florins per kilometer.

It is reported that a consolidation of one of the railway companies and an electric tramway has been effected for operating their properties by electric traction.

#### AUSTRIA-HUNGARY.

**Buda Pesth**—The electric tramway to Josefsring has been completed and is meeting with a liberal patronage.

The Budapest Pferde-Bahn Gesellschaft places its April business at 1,508,171 passengers.

The Budapest Stadt Bahn reports 337,200 passengers as having passed over its lines in April.

#### BELGIUM.

**Brussels**—The Brussels Tramway Company has completely abandoned the electric motor project.

#### ENGLAND.

**Birmingham**—The lately completed Birmingham Electric Railway has proven a success.

**London**—According to latest statistics, in the United Kingdom there are 1,357 miles of tramway, to operate which 27,060 horses, 539 steam engines and 3,645 cars are employed.

It is stated that the London Tramways Company has decided upon electric accumulator cars of the Jarman system at a cost not exceeding 4½d per mile.

The contract has been awarded for the construction of the electric tramway at South End.

The Wellingborough Tramroads Company will extend its lines from Bozeat to Olney, to connect with the Midland Railway, and from thence to Irchester, Higham, Ferrars and Rushden, the motive power to be electricity.

An electric line six miles long is to be built on the District Railway line from Acton to Hounslow by the Series Traction Company, motor to be 150 h. p. Estimated cost, £15,000.

#### FRANCE.

**Paris**—The electric tramway from the Arc de Triomphe to Courbevoie has been extended to St. Germain. This road will be fitted out with new rolling stock.

The electrical tramway line which has been running along the western boulevard has apparently met with encouraging success.

Work is energetically being pushed forward on the steep grade to Montmartre. It is estimated that this enterprise will cost (with a double track) about 4,000,000 francs.

#### GERMANY.

**Aix-la-Chapelle**—The Aachener-Burtscheider Pferde Eisenbahn Gesellschaft declared a dividend of 2 per cent. for 1889.

**Berlin**—The Berliner Pferde-Eisenbahn Gesellschaft reports 54,979.45 marks as its earnings for March.

The Grosse Berliner Pferde-Eisenbahn Actien Gesellschaft's passenger traffic for March yielded 1,162,262.70 marks.

The Berliner Pferde-Eisenbahn Gesellschaft's passenger traffic yielded 69,433.79 marks for April.

The newly erected passenger station of the Berliner Pferde-Eisenbahn Gesellschaft has been opened to the public.

The Grosse Berliner Pferde-Eisenbahn Actien Gesellschaft reports 1,201,788.24 marks as its earnings for April.

The passenger traffic of the Grosse Berliner Pferde-Eisenbahn Actien Gesellschaft for May footed up 1,276,727.73 marks.

The passenger traffic of the Berliner Pferde-Eisenbahn Gesellschaft for May footed up 85,127.36 marks

The Neue Berliner Pferdebahn Gesellschaft places its earnings for March, 1890, at 128,734.25 marks.

The Grosser Berliner Pferdebahn declared a dividend of 12½ per cent. for 1889.

The June receipts of the Neue Berliner Pferdebahn Gesellschaft is represented by 136,680 65 marks.

**Bonn**—The steam tramway project is at a stand still at present, with hopes of its early revival.

**Breslau**—The Breslauer Strassenbahn places its April earnings at 80,005 marks.

**Cassel**—The Casseler Strassenbahn Gesellschaft give 10,100.45 marks as the earnings for February.

**Chemnitz**—The Chemnitzer Strassenbahn has decided to extend its line to Schonau. Several miles of double track will also be laid.

**Cologne**—The Colnische Strassenbahn Gesellschaft's passenger traffic yielded 122,145.54 for May.

Work has been resumed in the construction of the Niederwald Tramway Line, and the road will probably be in operation within a very short time.

**Crefeld**—The stockholders of the Crefeld-Uerdinger Strassenbahn have voted to decrease the capital stock from 1,000,000 to 500,000 marks.

**Darmstadt**—The newly constructed Darmstadter-Arheiliger Dampf Strassenbahn has been opened for business. The trial trip was a success.

**Dessau**—The projected tramway is meeting with a great deal of encouragement, and the outlook is very favorable.

**Dresden**—The Dresden Pferdebahn Linie is rapidly nearing completion.

The passenger traffic for March of the Dresdner Strassenbahn is represented by 156,962.43 marks.

The Dresdener Strassenbahn Gesellschaft contemplates the introduction of the electric system on their Bohmischer Bahnhof Blasewitz line.

The Dresdner Strassenbahn report 192,073.50 marks as its May traffic, representing 1,300,194 passengers.

The old Dresden Pferdebahn Gesellschaft has decided to lay double tracks owing to increasing business.

**Dusseldorf**—The Dusseldorfer Trambahn has decided to declare no dividend for 1889.

The Dusseldorfer Tramway reports 302,694 francs as its earnings for 1889.

Tramway projects to facilitate communication with Gerresheim, Hamm, Grafenberg and Rath are meeting with considerable encouragement.

**Essen**—Work on the Essen Strassenbahn is being pushed forward to completion.

**Elberfeld**—The Elberfeld and Barmen Strassenbahn has contracted for the building of its road without delay.



**Ems**—The cable road has again resumed its regular trips.

**Eupen**—The Eupen Dolhain Dampf Strassenbahn is rapidly nearing completion.

**Frankfurt**—The business of the Frankfurter Strassenbahn for 1889 is reported as very encouraging.

The May earnings of the Frankfurter Tram-bahn Gesellschaft amounted to 137,186 3/4 marks.

**Gera**—It has been definitely settled that the projected local tramway will be built.

**Garlitz**—The Garlitzer Strassenbahn has under favorable consideration the construction of a branch line from Kaserne to Ringbahn.

**Graz**—The project of a tramway line to Schlossberg has been favorably considered by the municipal authorities.

**Halle**—A concession has been granted for an electric tramway.

**Hamburg**—The Grosser Hamburg Altonaer Strassenbahn Gesellschaft has equipped its Lubecksthor-Wilhelmstrasse Branch with new and elegant cars.

The Hamburger Strassen Eisenbahn Gesellschaft places its March earnings at 395,132 marks.

The Hamburger Strasser Eisenbahn Gesellschaft places its June earnings at 298,694.35 marks.

The Hamburger Strassen Eisenbahn Gesellschaft has under consideration the expending of 900,000 marks for extensions, etc., of its road.

**Heidelberg**—The cable tramway to Heidelberg Castle and Mollenkur has proved a great success.

The local tramway is rapidly nearing completion.

**Karlsruhe**—The tramway to Spock is assured, and the contract for its speedy completion has already been awarded.

**Kiel**—The Kieler Strassenbahn at its last general meeting voted to expend 100,000 marks in extending its road.

**Landhut**—The projected tramway is so vigorously endorsed by the public that its construction will be pushed forward without delay.

**Leipzig**—The Leipziger Pferde-Eisenbahn Gesellschaft's May traffic amounted to 169,388 marks.

**Lubeck**—The Lubecker Pferde-Eisenbahn Gesellschaft carried 87,949 passengers in 1889, yielding 20,225 marks.

**Magdeburg**—The Magdeburger Strassen Eisenbahn earnings for April amounted to 67,743 marks.

**Mannheim**—The Trambahn Mannheim-Ludwigshausen reports 22,232 marks as its income for 1889.

**Marienburg**—Work on the Konigswarter Strassenbahn is being vigorously pushed forward.

**Mayence**—The Mainzer Strassenbahn Gesellschaft carried 1,915,363 passengers during 1889.

Work on the extension of the Mainzer Strassenbahn to Gonsonheim-Furthen and Bretzenheim-Hechtsheim has been commenced.

All differences between the Mainzer Strassenbahn Actien Gesellschaft and the municipality of Weissenau having been amicably settled, the road will at once be extended to the latter point.

The contract for the construction of the suburban tramway lines has been awarded.

**Muhlhausen**—The government has taken charge of the Colmar-Horbung Strassenbahn.

**Mecklenburg**—The Mecklenburgische Strassenbahn earnings for April footed up 3,547 marks.

**Munich**—The project of a tramway from the King Max II. statue to Ludwig Strasse is favorably considered by the authorities.

**Nurnberg**—The municipal government has granted permission to the Nurnberger Strassenbahn to lay a double track from Karlstrasse to Lauferschaleghurm.

The Nurnberger Pferdebahn declared a dividend of 4 per cent. for 1889 against 2 1/2 per cent. for the previous year.

The Nurnberger Pferdebahn Gesellschaft has concluded to introduce electricity as a motive power.

**Posen**—The Posener Pferdebahn during 1889 carried 1,016,191 passengers, yielding 112,079 marks.

The Posen Pferde Eisenbahn declared a dividend of 1 3/4 per cent. for 1889.

**Reichenbach**—The projected Reichenbach-Leipes tramway line is meeting with considerable encouragement.

**Reichenberg**—The projected tramway line from Tannwald to Polaun is meeting with favor, and its friends are sanguine of success.

**Remscheid**—A projected local tramway is attracting general attention with every prospect of success.

**Riesa**—The Riesa Strassenpferdebahn has been completed and opened for traffic.

**Schleswig**—The contractors for the construction of the Schleswiger Strassenbahn are making every exertion to have it completed at an early date.

**Stettin**—The Stettin Strassen Eisenbahn declared a dividend of 2 per cent for 1889.

The Stettiner Strassenbahn gives 33,386 as its income for April.

**Stuttgart**—The Stuttgarter Strassenbahn is undergoing extensive repairs.

Owing to delay in delivery of rails ordered, work on the Stuttgarter Strassenbahn has been retarded. When the anxiously awaited material arrives the work will be pushed vigorously toward completion.

**Thorn**—A tramway line will be built to Kinderheim.

A project for a local street car line, backed by resident capitalists has met with such favor that 60,000 marks was at once subscribed. The enterprise now being assured of success it will be pushed forward as speedily as possible.

**Trier**—Work on the Trier Pferdebahn is progressing rapidly towards completion.

**Weimar**—The building of a street car line is now the absorbing topic, and the opinion is quite general here that it will be constructed.

**Weissenau**—It is generally believed that the projected tramway to connect Weissenau with Mayence will be a settled matter. If so, with the capital now ready to back the enterprise no delay will be permitted towards its speedy completion.

**Weisbaden**—Owing to continued complaints against the smoke and noise of the locomotives of the Weisbadener Strassen Dampfbahn the company is seriously considering their being replaced by electric motors.

**Wurzburg**—A project for the construction of a local tramway line is being enthusiastically agitated at present.

#### HOLLAND.

**Rotterdam**—The Rotterdamsche-Tramway-Maatschappij places its April income at 35,684.17 Nederland gulden.

The Rotterdamsche-Tramway Maatschappij reports its May earnings as 42,390.80 Nederland gulden.

#### ITALY.

**Ferrara**—The municipal government has favorably considered a project to build a steam tramway connecting that city with Cento, Ponte, Lagosco, Copparo, Costello Codigoro and Comaschio.

**Lombardy**—The Lombardy tramway reports 28,050 francs as the earnings of its passenger service.

**Lugano**—The Lugano-San Salvatore Tramway is now open for public patronage, with a line 1,644 metres in length; cost of road 600,000 lire.

**Lugo**—The municipal government has voted an annual subsidy of 40,000 lire to the Lugo, Fusignano-Alfonsine tramway.

**Monza**—The Monza-Barzano Steam Tramway company now operates 109,372 kilometres of road.

The Monzo-Barzano Steam Tramway company places its income for 1889 at 162,462 lire.

**Ostiglia**—A tramway is projected to unite Ostiglia and Polesella, passing through Melarra, Bergantino, Castelnuovo, Bariano, Mazzo, Kaito, Salara, Ficarole, Galba, Stienta and Occhiobello. The outlook is favorable.

**Padua**—The Societa Venata is vigorously pushing forward the construction of its latest project, a tramway to Piove. It will be completed by January, 1891.

**Piedmontese**—The Compagnie General des Tramways a Vapeur Piedmontains reports an income of 742,958 francs for 1889.

**Rome**—The Rome Electric Tramway, just completed, and the first electric railway built in Italy, extends from Porta del Popolo to beyond the Ponte Molle, a distance of 2 miles.

**Vercelli**—The Vercelli-Biella Tramway which temporarily ceased running has been re-opened to business.

#### RUSSIA.

**Kalisch**—A projected tramway to Ostrous to cost 70,000 roubles is favorably considered by Russian capitalists.

**St. Petersburg**—Work will commence without delay on a tramway line to Ssestrozek, with a branch to Sissji-Noss. Length of road 28 versts; to be completed before January 1, 1893; limit of charter: 60 years.

#### SPAIN.

**Seville**—The Seville Tramway places its March income at \$4,205.

**Barcelona**—The March receipts from passenger traffic is given as \$20,260.

#### SWEDEN.

**Christiania**—The Christiania Tramway declared a dividend of 7 per cent. for 1889. The sum of 250,000 krs. will be expended in extending its lines.

#### SWITZERLAND.

**Berne**—The Berner tramway is being built with the greatest dispatch.

The municipal government has passed an ordinance prohibiting vehicles—other than cars—from using the tramway tracks.

**Birsigthal**—The May earnings of the Birsigthal Bahn foot up 14,417.10 francs.

**St. Gall**—A franchise has been granted for a tramway to connect Filisur with Samanden. Work will be pushed forward with a view to its early completion.

**Zurich**—The Zurich Strassenbahn has declared a dividend of 3 3/4 per cent. for 1889.

The earnings of the Zurich Strassenbahn for 1889 are placed at 346,406 francs.

The interest in the projected tramway seems to lie dormant for the present.

The Zurich Strassenbahn's passenger traffic for May yielded 34,251.15 francs.

#### SOUTH AMERICA.

**Buenos Ayres**—The Buenos Ayres and Belgrana Tramway receipts for February are placed at \$42,555.

#### Cars for Electric Traction Work.\*

To doubt their abilities to turn out the best possible designs of cars for electric lines as well as general tramway work may, perhaps, appear no great compliment to the carriage and wagon builders of this or any other country; and yet, without absolutely wishing to impute a want of being up to date-ness, one cannot help wondering whether every single detail of these designs has received such consideration as details notoriously deserve.

In dealing with vehicles to be propelled for public use along roads or tramways, it seems to me (especially in the present state of our knowledge and experience) most essential that every conceivable care should be taken to cut down useless weights and employ only such material in such proportions as may be truly consistent with two great requirements—*strength* and *lightness*.

In any case, of course, it is a simple matter of common sense to save the expenditure of power in moving superfluous weights; more especially is this so when such power is obtained at considerable cost owing to natural disadvantages, or when the weights necessary to be moved are of large amount.

A true engineer—whose business it is to economize natural forces and use them to profitable advantage with little waste—will gladly avail himself of all improvements which tend to such results.

It may be too much to expect that he will adopt them if there be no personal profit likely to accrue; but he should certainly not be found opposing the introduction of improvements that bring about a great economy of time and energy.

This is *apropos* of what forms, without doubt, a characteristic of this country; we are decidedly slow in adopting proposed changes, even when they are shown to be beneficial.

Returning to our cars, however, the question at issue resolves itself into an inquiry as to whether a tolerable state of perfection has been reached in the design and construction of tramway cars, more especially in view of the rapid spread of electric traction even in England.

As for America, of course we are far behind the results there attained; and, perhaps, it is as well. We have, at any rate, the experience of others to profit by, and the changes made here will be more permanent and enduring when they do come to pass.

There is no need in this place to enter into a discussion of the various methods or systems of electric traction; it may be assumed with safety that throughout our English towns and cities but one system will be permitted, or will prove really workable along crowded streets and thoroughfares.

The public authorities are dead against the use of overhead wires for such purposes; underground conduits are very expensive to install, and sometimes the groove presents disadvantages, so that the plan of using accumulators in automotive cars proves to be the only resource left.

The weight of these accumulators forms a very heavy item in the total car load, being, as a rule, quite as much, if not absolutely more, than that of the passengers or pay-

\* "Electrical Review," London.



ing load, and hence it becomes a most important question to ascertain whether all that is possible has been done to lessen the dead weight of electric tramcars.

At present, unfortunately, there seems little or no prospect of any great saving being effected so far as the accumulators themselves are concerned, much as it might be desired. Until our inventors have devised some better material than lead as a basis for secondary batteries we shall be able to gain little or nothing in this direction.

There is, however a tendency (even with the employment of lead) towards increasing the output of energy per pound of battery weight, but this has a theoretical as well as a practical limit. The electric motor and gear do not form a large fraction of the total weight, so that even if a further saving of weight could be made in them it would not be worth the corresponding decrease in strength or efficiency. The experience already obtained with generators and motors enables us to construct them with almost perfect efficiency, and the proportion of output to weight has practically increased to its greatest limit under present conditions.

The greatest reduction should certainly be looked for in the accumulators, but, pending developments in this direction, there is no possible harm in making sure that our cars themselves are as light as they can well be, consistently with the needful strength.

The most general types of tramcar at present in use, both in this country and the United States, are four in number. Taking these in their order of size, and starting with the smallest, we find that it has an average seating capacity for sixteen passengers inside; it is of the closed car type, and therefore without facilities for carrying passengers outside. The average weight of such a car ready for use may be taken at 30 cwt., or 3,360 lbs.

Sixteen passengers will average 150 lbs. each, so that the paying load is about 2,400 lbs., and the ratio of paying load to car weight becomes .71. These figures are taken from data supplied by the ordinary horse car service, but it may be shown that pretty nearly the same proportion holds good in the few instances where electric cars of this size are at work.

At Lafayette, Ind., the twelve feet passenger cars, with seating capacity for about sixteen passengers, have each a total weight of 4,100 lbs. Deducting, say, 25 per cent. of this for the motors (two in number, of  $7\frac{1}{2}$  horse power each) and the necessary gear, we have, approximately, 3,000 lbs. as the dead weight of the car; and with the same weight of passengers this works out to a ratio of about .78 between paying load and weight of car.

This appears to show that American car construction is slightly better than that of this country, so far as lightness is concerned, but the difference is not very material. Proof of such a statement is better shown by the fact of so many cars of American origin being seen at work in our midst.

The second type of tramcar, and the next in size, is that so prevalent in the States, and known as a sixteen feet closed car, having a seating capacity of about twenty-two passengers.

Taking the average of eight lines, all worked by electricity and in operation throughout the United States, the weight of the car with motor or motors, gear, etc., complete come to about 5,700 lbs. From this should be deducted at least 25 per cent for motors and gear, assuming the same average weight for passengers, we have a total ratio of 3,300 to 4,275, that is .79—approximately the same result.

As a matter of fact, however, the practical ratio of paying load to dead weight of car would be found to average in the States nearly double the amount above named, for the simple reason that the seating capacity is barely half the carrying capacity.

There is no need to use outside seats on these cars; passengers crowd in utterly regardless of sitting room, and the proverbial barreled herrings (if they could only move them) would wag their tails in sympathy with fellow-sufferers. Of course this overcrowding would not be permissible to such an extent in this country, and hence the seating capacity of cars is as fair a standpoint as any by which to judge of their merits or demerits.

Coming next to the third type of car, that usually seen on our English tramways drawn by two horses, and with seats on the top, the average weight, as given by a competent authority, is 50 cwt., or 5,600 lbs. These cars can seat between 46 and 50 passengers; but assuming 48 as a mean, we have a total paying load of 7,200 lbs., and a ratio between this load and the weight of car of 1.3.

This represents a considerable improvement, and is perhaps the best result so far achieved.

From such data as may be gathered from the sadly too sparse instances of electric cars built on this plan, practically the same result is given, showing that the carrying capacity of cars increases, as might of course be expected, in a greater ratio than their weight.

The fourth and last type of car is that known as the double truck, or double bogie car, with top seats, and carrying an average of 60 passengers.

The weight of such a car is given as about 80 cwt., or 8,960 lbs. With a seating capacity of 60 persons the ratio is a little over 1. This is a slightly worse result than in the last case, but might obviously have been expected because of the increased weight in trucks and wheels. At the same time this increase is far more than compensated for by the greater ease of traveling and better application of electric motor and accumulators.

This question of car framework is, to electricians, an extremely interesting and profitable one for discussion, but it opens up too wide a field to adequately occupy just now, although more may yet be said thereon in another connection and from a mechanical point of view.

So far as the figures given are able to prove anything they show that the large cars are the more profitable to run, so long, of course, as the conditions of traffic render their use advisable. That is, a frequent and heavy service will best be met by the employment of large cars with

considerable carrying capacity in proportion to their weight.

When the traffic is at less frequent intervals over a long line, probably it would still pay best to run large cars at stated times, but this is a matter that concerns the traffic manager rather than the electrical superintendent.

As to whether the weights of those cars might possibly be reduced even slightly so as to effect a saving in the power required to drive them, we may be able to gauge the likelihood of this by making a comparison with the weights of vehicles used for carrying goods or minerals.

English railway rolling stock is notoriously heavy and antiquated; one may, for instance, often see tranship vans designed to carry, say, 11 tons and having a net weight of no less than 14 tons. That is, the paying load is considerably less than the weight of the van itself.

Of course this follows as a result of modeling railway stock upon the lines of farm wagons; rigid axles and heavy construction might have served a useful purpose in the days of bad turnpike roads, but on the solidly built English tram or railway lines they are simply out of place—especially with the high speeds now employed.

On horse tramways some small saving might be made in the cars, although we have seen that the large type vehicle shows a fair proportion (1.3) between paying load and weight of car; but whether this saving is enough to warrant an entire change of the rolling stock is, to say the least of it, doubtful.

It is principally in the new accumulator cars (which must inevitably lead the way in electric traction for some time to come) that a saving of more considerable amount may be made. These cars must necessarily be of greater strength than those of the usual type, from the fact of their carrying at least one and one-half tons of extra weight in the shape of lead accumulators.

There will probably be a tendency to gain such extra strength at the expense of lightness; and some change will be needful in the design of these cars in order to obtain sufficient strength to bear the additional load with the same or less net car weight.

Judging from the results obtained in American freight car practice, as already instanced, there would seem to be considerable promise of economy in weight, coupled with increase of strength, from the use of iron tubes in the car framework. Not only do they allow of easy construction and repairs, but by employing them a much better design of car is possible, the framework resolving itself practically into what is certainly not the weakest of engineering structures, viz., the truss bridge.

#### Patents.

The following is a complete list of such patents as relate to street railway interests, issued between July 1, and July 24, especially prepared for the STREET RAILWAY GAZETTE by Messrs. Higdon & Higdon, solicitors of patents and trade marks, room 36 Le Droit building, opposite U. S. Patent Office, Washington, D. C. A printed copy of any patent here named will be furnished by them for 25 cents (stamps).

#### Issue of July 1, 1890.

- 431,430. Fare Collector, Arthur W. Berne, assignor to B. W. Taylor, New Orleans, La.  
 431,431. Fare Collector, Arthur W. Berne, assignor to B. W. Taylor, New Orleans, La.  
 431,029. Car Starter, Charles G. Bloomer, Pawtucket, R. I.  
 431,256. Suspended Electric Railway and Car, Frederick E. Drown, Pawtucket, R. I.  
 431,519. Electric Railway, Rudolph M. Hunter, Philadelphia, Pa., assignor to Thomson-Houston Electric Company of Connecticut.  
 431,065. Tension Car Indicator for Cable Railways, Gabriel Leverich, South Orange, N. J.  
 431,213. Electric Motor for Railway Cars, William M. McDougall, East Orange, N. J.  
 431,072. Street Railway Car Truck, John B. Odell, Chicago, Ill.  
 431,478. Barke Operating Mechanism for Railway Cables, John H. Pendleton, Brooklyn, A. Bryson, Jr., and L. Moses, assignors to Rapid Transit Cable Company, New York, N. Y.  
 431,482. System of Distribution for Electric Railways, Elias E. Ries, assignor to Ries & Henderson, Baltimore, Md.  
 431,235. Dynamo-Electric Machine, Oliver B. Shallenberger, Rochester, assignor to Westinghouse Electric Company, Pittsburgh, Pa.  
 431,216. Regulation of Dynamo-Electric Machines, William Stanley, Jr., Great Barrington, Mass.  
 431,217. Self-Regulating Dynamo-Electric Generator, William Stanley, Jr., Great Barrington, Mass.  
 431,218. Self-Exciting Alternating Current Electric Generator, William Stanley, Jr., Great Barrington, Mass.  
 431,114. Electric Railway Conductor, Elihu Thomson, Lynn, Mass.

- 431,092. System of Electric Locomotion, Frank Wheeler, Meriden, Conn.  
 431,093. System of Electric Locomotion, Frank Wheeler, Meriden, Conn.  
 431,094. Switches for Electric Railway Systems, Frank Wheeler, Meriden, Conn.  
 431,095. System of Electrical Locomotion, Frank Wheeler, Meriden, Conn.  
 431,242. Rail for Street Railways, Reynolds T. White, Boston, Mass.  
 431,099. Cable Tramway, William E. and W. M. Winby, Birmingham, county of Warwick, England.  
 431,134. Dynamo-Electric Machine, Chas. F. Winkler, Troy, N. Y.

#### Issue of July 8, 1890.

- 431,684. Trolley Pole-Supporting Mechanism, Johan M. Andersen, Boston, Mass.  
 431,936. Cable Grip Car, Benjamin F. Crow, St. Louis, Mo.  
 431,658. Chain Grip for Cable Roads, William Heckert, Yonkers, N. Y., assignor to B. Butterworth, trustee, Cincinnati, O.  
 431,973. Hanger for Trolley Wires, John T. Herty, Boston, Mass.  
 431,720. Electric Railway, Rudolph M. Hunter, Philadelphia, Pa., assignor to Electric Car Company of America.  
 431,977. Electric Railway, Rudolph M. Hunter, Philadelphia, Pa., assignor to Thomson-Houston Electric Company of Connecticut.  
 431,812. Dynamo, Edward H. Johnson, New York, N. Y.  
 431,947. Street Car Heater, Hosea W. Libbey, Boston, Mass.  
 431,618. Regulator for Dynamo-Electric Machines, Gustavus A. Polson, assignor of one-half to S. Carey, New York, N. Y.  
 431,711. Electric Railway, Sidney H. Short, Cleveland, O.  
 431,823. Electric Railway Motor, Frank J. Sprague, assignor to Sprague Electric Railway and Motor Company, N. Y.  
 431,633. Conduit for Electric Railways, Joseph H. Wehrle, Newark, N. J.  
 431,634. Electric Railway, Joseph H. Wehrle, Newark, N. J.

#### Issue of July 15, 1890.

- 432,115. Street Car, John A. Brill, Philadelphia, Pa.  
 432,020. Brake for Motor Cars, Harry A. Crossley, Cleveland, O.  
 432,387. Armature for Dynamo-Electric Machines, Oscar A. Enholm, assignor of one-half to J. M. Heyman, New York, N. Y., and E. D. de Brie, Cognac, France.  
 432,391. Steam Motor, John H. Fedeler, New York, N. Y.  
 432,049. Electric Railway, Rudolph M. Hunter, Philadelphia, Pa., assignor to Thomson-Houston Electric Company of Connecticut.  
 432,142. Electric Locomotive, Walter H. Knight, New York, N. Y.  
 432,054. Cable and Street Railway Crossing, Jacob Lamplugh, Philadelphia, Pa.  
 432,143. Adjustable Fender or Guard for Street Cars, Howard B. Lent, Boston, Mass., assignor of one-half to E. N. Higley, New York, N. Y.  
 432,416. Conduit for Electric or Cable Railways, John Lynch, Washington, D. C.  
 432,204. Means for Electric Locomotion, James F. McLaughlin, Philadelphia, Pa.

#### Expiring Patents.

The following patents will shortly be public property and may be used by any one.

Manufacturers may determine to what extent they may act independently of patent rights, and inventors may gain an insight into the prior state of the art by consulting copies of them.

A printed copy of any of the drawings and specifications of any of the following will be furnished by Messrs. Higdon & Higdon for 25 cents.

#### Expire During August.

- 142,135. Car Replacer, A. Whittemore.  
 141,474. Car Starter for Street Railways, M. Toulmin.  
 141,856. Car Lamp, J. E. Cross.



Electric Street Railways in North America.

IN OPERATION OR UNDER CONTRACT JULY 1, 1890.

Table listing electric street railways in North America, including columns for Operating Co., Location, System, Cars, and Miles. Entries include Adria Electric Ry., Akron Electric Ry. Co., Albany Railway Co., etc.

Continuation of the table listing electric street railways, including entries like Allegheny, Pa., Allegheny, Pa., Allegheny, Pa., etc., with columns for Operating Co., Location, System, Cars, and Miles.

Street Railway Securities.

NEW YORK AND BROOKLYN.

REPORTED BY R. L. GRANT, DEALER, No. 145 BROADWAY, N. Y. CITY.

Table of Street Railway Securities, listing various bonds and mortgages with columns for Name of Company, Par Value, Capital, Period, Rate, Last Div., and Bid/Asked prices.



Table with columns: NAME OF COMPANY, Par vl, Capital, Period, Rate, Last Div., Bid., Asked. Lists various companies like Ninth Avenue, Second Avenue, etc.

Table with columns: NAME OF COMPANY, Par vl, Capital, Period, Rate, Last Div., Bid., Asked. Lists various companies like Chicago City Railway, Chicago City Railway—stock, etc.

Associations.

OFFICERS, DATES OF MEETINGS, ETC.

AMERICAN ST. RY. ASSOCIATION.

President, Thomas Lowry, Minneapolis, Minn. First Vice-president, C. Densmore Wyman, New York. Second Vice-president, J. C. Schaffer, Indianapolis, Ind. Third Vice-president, Robert McCulloch, St. Louis, Mo. Secretary and Treasurer, Wm. J. Richardson, Brooklyn.

EXECUTIVE COMMITTEE.

The President, Vice-Presidents, and Geo. B. Kerper, Cincinnati, O. Geo. W. Kiely, Toronto, Can. R. Semmes, Memphis, Tenn. F. H. Monks, Boston, Mass. Francis M. Eppley, Orange, N. J. The annual convention of the Association will be held at Hotel Iroquois, Buffalo, N. Y., commencing on Wednesday, Oct. 15, 1890.

N. Y. ST. RY. ASSOCIATION.

President, John N. Partridge, Brooklyn. Vice Presidents, Daniel B. Hasbrouck, New York. P. B. Brayton, Syracuse. Secretary and Treasurer, William J. Richardson, Brooklyn. The annual meeting of the Association will be held in Rochester on September 16, 1890.

MASS. ST. RY. ASSOCIATION.

President, Chas. H. Odell, Salem. Vice-Presidents, H. M. Whitney, Boston. Amos F. Breed, Lynn. F. O. Stearns, Swansea. Secretary and Treasurer, J. H. Eaton, Lawrence. Regular meeting day, first Wednesday in each month.

THE ST. RY. ASSOCIATION OF THE STATE OF NEW JERSEY.

President, John H. Bonn, Hoboken. Vice-President, S. S. Battin, Newark. Secretary and Treasurer, Charles Y. Bamford, Trenton.

EXECUTIVE COMMITTEE.

John H. Bonn, Hoboken. S. S. Battin, Newark. C. Y. Bamford, Trenton. C. B. Thurston, Jersey City. John Hood, Camden. A. Q. Keasbey, Elizabeth.

OHIO STATE TRAMWAY ASSOCIATION.

President, Wm. B. Hayden, Columbus. Vice-President, John N. Stewart, Ashtabula. Secretary, A. E. Lang, Toledo. Treasurer, J. B. Hanna, Cleveland.

EXECUTIVE COMMITTEE.

Ross Mitchell, Springfield. The annual convention of the Association will be held in Columbus, O., on November 19, 1890.

WESTERN ELECTRIC RAILWAY ASSOCIATION.

President, T. J. Evans, Council Bluffs, Ia. Vice-President, H. E. Teachout, Des Moines, Ia. Secretary, W. L. Allen, Davenport, Ia. Treasurer, W. R. Moore, Moline, Ill.

NATIONAL ELECTRIC LIGHT ASSOCIATION.

President, M. J. Perry, Providence, R. I. 1st. V. President, E. A. Maher, Albany, N. Y. 2nd. V. President, C. L. Edgar, Boston, Mass. Sec. and Treas., A. V. Garratt, New York.

EXECUTIVE COMMITTEE.

Chairman, C. R. Huntley, Buffalo, N. Y. E. R. Weeks, Kansas City, Mo. James English, New Haven, Conn. F. A. Armstrong, Camden, N. J. C. H. Wilmerding, Chicago, Ill. M. J. Francisco, Rutland, Vt. A. F. Mason, Boston, Mass. John A. Sheley, New York. H. K. Thurber, New York. Next convention will meet at Stockton Hotel, Cape May, N. J., on August 19, 1890.

AMERICAN INSTITUTE OF ELECTRICAL ENGINEERS.

President, Elihu Thomson. V. Presidents—Dr. Louis Duncan, Francis R. Upton, T. Cammerford Martin, Edward Weston, Major O. E. Michaelis and Prof. Edward L. Nichols. Treasurer, George M. Phelps, 150 Broadway, New York. Secretary, Ralph W. Pope, 5 Beekman St., New York. Managers—Dr. Schuyler S. Wheeler, Joseph Wetzler, Francis B. Crocker, John W. Howell, Charles Cuttriss, George B. Prescott, Jr., Thomas D. Lockwood, William Maver, Jr., Dr. F. Benedict Aerzog, Prof. Wm. E. Geyer, H. C. Townsend and Henry Van Hoesenburgh. Board of Examiners—W. B. Vensize (chairman), F. W. Jones, C. O. Maillonx, E. H. Birdral and Edward P. Thompson.

Book Reviews.

"Our Flag" or the evolution of the stars and stripes, including the reason to be of the design, the colors and their position, mystic interpretation, together with selections, eloquent, patriotic and poetical, by Robert Allen Campbell, Chicago, H. E. Lawrence & Co., 98 State street.

This little book, of 128 pages with handsome dark blue cloth cover, with gilt title and flag, is dedicated to "every man and woman who loves our flag as the emblem of government of the people, by the people, for the people; who hail the stars and stripes as the hope of all who suffer, and the dread of all who wrong; who reveres the red, white and blue as the symbol of aspiration, intelligence and industry, which will, in due time establish and maintain the universal brotherhood of man,"—is an outline sketch of the history of the Union flag, and a compilation of facts and dates from official sources, larger works, occasional pamphlets, and addresses, upon both this and collateral subjects. The book treats upon the whole history of the flag, from the time of the landing of Columbus up to the present. It gives illustrations of Queen Isabella, Christopher Columbus, his landing in 1492; Cabot, &c., together with sketches of the colonial flag; the original stars and stripes—with its mystic meaning and esoteric interpretation; portraits of John Hancock; John Paul Jones, Franklin, Washington, Heinrich Hudson and many others whose names are contemporaneous of the history of the U. S. The volume closes with a number of selections, in prose and verse, including "Yankee Doodle" "Star Spangled Banner" etc. The book is printed in large sized type, on very heavy paper, and is admirably adapted for the perusal of those who have but little time for an extended study in this particular line of investigation.

"Electricity for Engineers," by Charles Desmond. The Engineers' Company. 1890. \$1.00.

In his extremely interesting volume of 255 pages and 77 illustrations, Mr. Desmond has supplied to engineers a book of considerable value as an educator in the science of electric engineering.

The technicality of the subject rendered it a matter of considerable difficulty for the author to handle it so that to even the merest tyro the subject matter is clear and intelligible, but in "Electricity for Engineers" this has certainly been accomplished.

Starting in with the query, "What is Electricity?" the author carries the reader through the different parts of the dynamo—the magnet, field, coils, armatures, etc; the different systems of construction are fully detailed. Electric lighting in all its ramifications is fully described (excepting by the alternating system which will be subject of a second volume).

The chapters on testing by means of amperemeters, volt meters, galvanometers, the Wheatstone Bridge, etc., are particularly interesting, as also is the dissertation on sparking.

While the author of the work does not claim that its perusal will complete the higher education of an engineer, yet it will certainly carry him well up to that point where by both practice and theory he will be enabled to comprehend and follow out the higher problems and theories of electrical engineering.

The number of details of practical experience with dynamos and lamps, showing the troubles that most frequently occur, with the means used to prevent or overcome them, can not but be of considerable value to those in charge of a lighting plant; as all the points have been worked out by the author in his own experience with the machines and lamps of the various systems described in the book.

The sixth weekly issue of the Stationary Engineer lies before us; the first weekly number was issued on July 5th, and while it may have appeared somewhat doubtful to many whether or not the constituency it represents would support such frequent issues, yet the very healthy and prosperous appearance of its sixth number evidences the fact that, when they changed from 12 to 52 issues a year, the publishers showed both wise judgment and admirable foresight.

"Practical, Sanitary and Economic Cooking, Adapted to Persons of Moderate and Small Means," by Mrs. Mary Hinman Abel, 190 pages, in cloth. Am. Pub. Health Association, publisher.

A valuable and useful book to those of moderate means; and especially to those whose culinary education has been neglected.

"Live Questions—Including our Penal machinery and its Victims," by John P. Altgeld. Chicago: Donohue & Henneberry. 320 pages, cloth.

A perusal of this book shows us that it treats, somewhat exhaustively, on some very vital questions of to day, such as the prison problem, the Australian system of voting; the compulsory arbitration of strikes; anonymous journalism and its effects; together with a dissertation on the 8-hour movement; and many other very interesting subjects. The book is well worth reading, and is of considerable value to the capitalist, jurist, or political economist.

"American Street Railway Decisions, being a Collection of Cases Decided in various Courts, within the United States and Canada," edited by Charles A. Richardson and Alfred G. Hook. Vol. 1. Am. St. Ry. Assn., Brooklyn, N. Y., Publishers.

The volume embraces all reported cases from 1841 down to and including a part of the year 1870. It is presented very handsomely, bound in sheep, in regular legal form, and is absolutely invaluable to street railway managers and corporation attorneys.

We have received Vol. IX No. VII of The American Silk Journal of New York, and congratulate the proprietors, the Rose and Trumbull Co., on their having donned such an appropriate cover. When a journal can afford to wear a watered silk coat and to appear regularly every month for two dollars per year, it is evident to us that, as the apparel proclaims the man, the Am. Silk Journal can substantiate its claim of being "all silk and a yard wide"—in scope and valuable information.

THE ELECTRIC RAILWAY OF TO-DAY is the title of an extremely interesting and well-known book of fifty-six pages, with thirty-seven cuts, recently issued from the press of E. B. Sillings & Co. of Boston, by H. B. Prindle.

The subject of electric railways, of all systems, is presented in a popular form, and in such language as can be readily understood by everybody, even those who are ignorant of the significance of technical terms.

The book should have a large sale.

It would not surprise us in the least if some of the enterprising business men in the South were to take advantage of the magnificent hardwood forests of Tennessee and contiguous states and to go into the business of street car building. According to the reliable statistics, and allowing for the tremendous growth of the street railway industry, it would appear to us that there is certainly room sufficient to keep one more street car factory pretty busy in supplying cars for the South, but such industry would have to be where railway facilities would enable it to ship its output promptly and at low rates.



# The Street Railway Gazette.

(Copyrighted, 1890.)

Vol. V.

CHICAGO.

SEPTEMBER, 1890.

CHICAGO.

No. 9.

## Electric Railways.

### RIVER AND RAIL SYSTEM \*

The fascination of the storage battery idea grows greater day by day, and managers of street railway companies frequently either go themselves

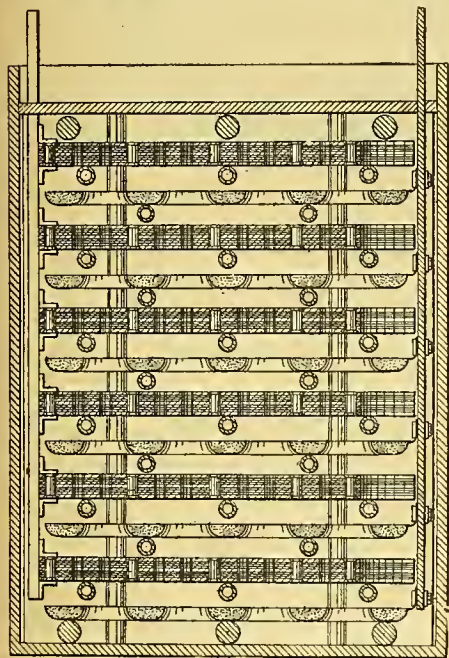

FIG. 1.—THE MAIN STORAGE BATTERY.

or send their superintendents or experts thousands of miles to witness the tests of some new method of electrical traction, notably that by means of the storage battery, and to render a

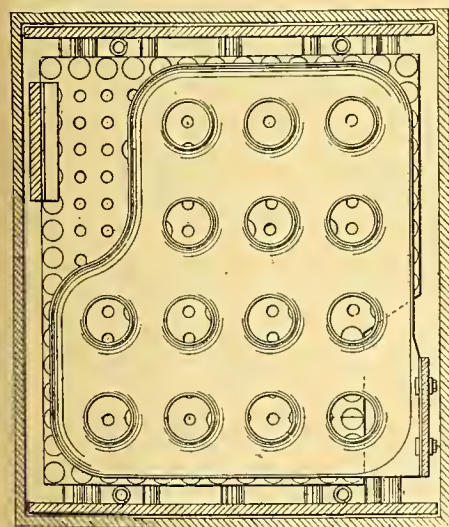

FIG. 2.—THE MAIN STORAGE BATTERY.

report thereon. Only a week or two ago quite a large party of gentlemen from Washington and other cities, accompanied by a representative of THE STREET RAILWAY GAZETTE,

\* River and Rail Electric Light Co., New York City.

visited Fort Hamilton to witness the operation of the electric storage car on the dummy line.

The battery itself is of the zinc-lead type, and the idea of the same has been followed up and perfected by the company's electrician, Prof. Main.

A very comprehensive and explicit description of the *technique* of this system comes from the able pen of Mr. John Wetzler, and appears in a recent number of the *Electrical Engineer*, in which, regarding the battery, it is stated that "it will be remembered that early in the art M. Reynier experimented with this type of cell, using the zincs as the negative plates, but the results which he obtained were not sufficiently encouraging to warrant the general adoption of this type. The results of Prof. Main's experiments in this direction, however, soon convinced him that the difficulties encountered by M. Reynier were attributable mainly to the fact that his plates were disposed vertically in the

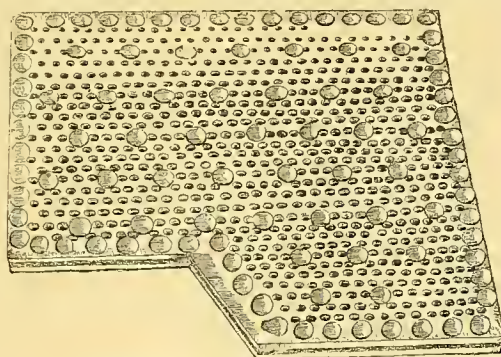

FIG. 3.—POSITIVE PLATE OF THE MAIN BATTERY.

solution. The result of this arrangement was that the zinc plates, on account of the difference in density of the solution at various points, were unequally acted upon, and indeed frequently cut away. This phenomenon is also noticed in primary batteries in which zinc is employed, and in which the part at the bottom of the cell is usually eaten away considerably faster than that at the top. The natural remedy for this defect was recognized by Prof. Main, and applied by placing the plates in a horizontal position, so that, notwithstanding differences in density of the solution, each separate plate would be surrounded by a layer of solution having the same specific gravity throughout.

"The arrangement adopted is illustrated in Figs. 1 and 2, which represent the cell in vertical and horizontal section respectively. The positive or peroxide plate, it will be seen, consists of two outer sheets of lead, between which is placed a layer of sheets of thin lead foil. The plate is perforated, as shown in Fig. 3, and riveted together at numerous points. This plate when placed in the battery and worked for a short time, is acted upon so as to convert the lead foil into

peroxide, which is firmly held in place. The negative plate, which is shown in Figs. 1 and 2, consists of a copper tray perforated and into which amalgated zinc is poured so as to completely fill the tray, as shown in Fig. 1.

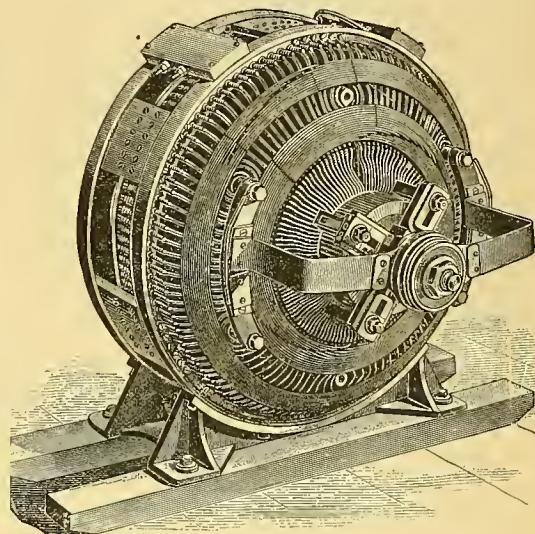
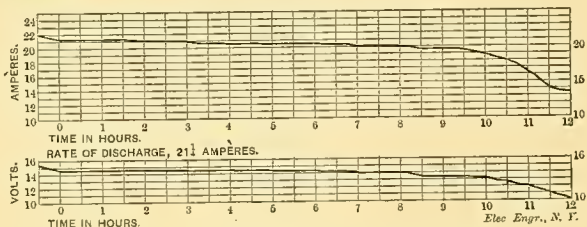

FIG. 6.—THE MAIN MULTIPOLAR CAR MOTOR.

A very small number of charges and discharges serve to convert the zinc amalgam into a highly porous and spongy mass, having a great property of absorbing hydrogen. The cell employed on the car has 14 plates and weighs 45 pounds, of which 27 pounds is the weight of the metal proper. It has a capacity of 250 ampere hours; 60 of these cells are employed on a car.

"The action of the cell under charge and discharge is well shown in the curves, Figs. 4 and 5, which give the results of some recent tests and are sufficiently clear without further explanation.

"Having thus described the battery, we will say that the distinguishing features of the car are the rounded ends which furnish the space in which the motor man is placed so as to leave a clear passage for the entrance and exit of passengers. In this space are the controlling



FIGS. 4 AND 5.

switch and lever and the brake, placed conveniently for the manipulation of the motor.

"The essential feature of every electric car, the electric motor and the gearing, deserves in this instance special consideration, as both



these elements have been worked out by Prof. Main on entirely new lines from the practice heretofore in vogue. Prof. Main was among the first to recognize the fact that increased economy could be obtained by an arrangement in which the motor is kept revolving at a constant speed, and at which it operates at the greatest efficiency. At the same time he recognized the fact that an element of almost equal importance is the nature of the gear connecting the motor with the axle.

"Taking up the motor first, Prof. Main was among the first also to develop the design in which the armature is kept stationary and the field magnets revolve, and he has carried this still further in maintaining the wire on the field magnets also stationary, so that in reality there are no moving wires whatever on the motor. The latter is shown in perspective in Fig. 6. Prof. Main has adopted the multipolar type of machine with a particular arrangement, which is clearly shown in section in Fig. 7. Here, it will be seen, the armature *A* is held stationary by the casing and is surrounded on both sides by field magnets, one of which is shown at *N N*; opposite to this is a wood filling, the object of which will be explained presently. Placed at right angles to the poles *N N* is a similar pair, having an opposite or south polarity. The filling shown opposite the poles *N N* is of wood, the object being to fill up the spaces between the two arms of each pair of magnets, in order to avoid churning of the air and so as to give smooth working.

"The core of the magnet *D*, it will be seen, is mounted directly upon the shaft of the armature and is surrounded by the magnetizing coils, which are placed in the cylindrical casing marked *M M*. This casing is stationary, as is also the magnetizing coil. The result of this construction is that both pair of poles of the magnetic system are influenced by a single magnetizing current, and hence are of a uniform strength, so that the action of each pole upon the armature is identical.

"Another object secured by this construction is the shortening of the magnetic circuit. It will be understood, from what has been said, that the lines of force emanating from both north poles *N N*, for instance, pass into the armature

convolutions being separated by insulating material; the ring is wound in Gramme fashion, with special connections on account of the employment of four poles. The commutator also remains fixed, the brushes alone revolving. The motor shown and employed on the car revolves at 800 revolutions per minute, which

ever, are slightly eccentric and have loose pinions mounted upon them, which mesh at all times with the internally toothed gears which surround them. These pinions may revolve idly with the gears, or may drive them, according as they are allowed to gyrate with the eccentric and revolve, or to gyrate only, the pinions

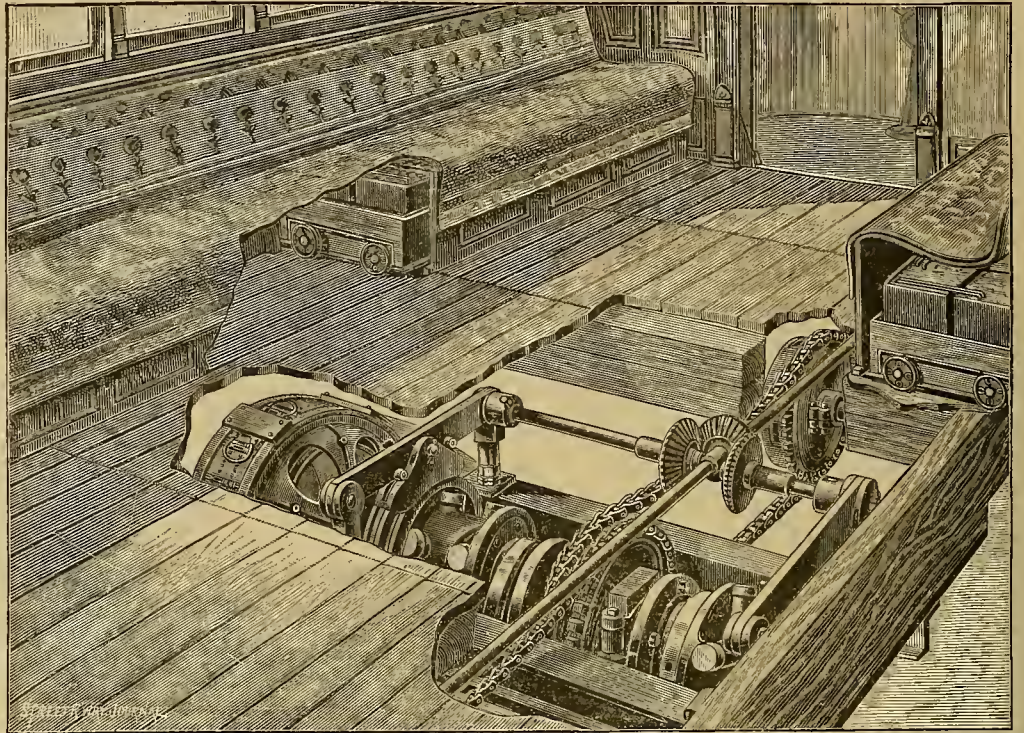

FIG. 8.—RIVER AND RAIL SYSTEM DRIVING MECHANISM.

corresponds to a speed of 12 miles an hour for the car.

"The motor is directly connected with the driving mechanism, which is shown in perspective in Fig. 8, and which constitutes a radical departure from the methods heretofore employed in electric car practice. As remarked above, the motor is kept in continual revolution, and hence some gear must be employed in which starting and stopping can be accom-

being connected by double gimbal joints to discs concentric with the central shaft. Each disc will, therefore, revolve with its pinion when idle; but when arrested by the grip jaws, operated by means of the beveled gear wheels and shaft shown, they will cause the pinion to drive according to the direction in which the beveled gears are turned by the motor man; either one pinion or the other will drive, with the result that the car can be driven at two different speeds, slow and fast, notwithstanding the uniform speed of the driving motor. By releasing both grip jaws, neither pinion drives, and the car may be brought to a standstill with the motor revolving at full speed.

"These operations of clutching are performed by the motor-man by means of a lever on the platform. The two internally toothed gears are connected permanently to each other and to the double sprocket which drives both chains, and action comes from either one or the other, or from neither, as the case may be. The driving sprocket wheels are connected to either axle so that both are driven direct. The whole mechanism is lubricated automatically from within by centrifugal action. The oil, as it drops down, is caught in a pan which encloses the whole under the car, and by means of a loose traveling ring returns to a reservoir and is used over and over again. The friction on the gimbal joints is exceedingly small, the motion of the rubbing surfaces being reduced to a small fraction of an inch, and as the internal gears mesh over a considerable part of their circumference, and are in addition completely flooded with oil, as well as protected from dust, their life is also indefinite.

"In order to avoid all shock on starting the car, the sprocket wheels attached to the axles are mounted on drums which contain springs so arranged as to keep the chains taut and to receive the first impulse in starting. The action of the spring is to allow a certain amount of relative motion between the two axles, thus avoiding the hard driving action experienced when both axles are geared to one motor. The tractive power is therefore utilized without rigidity, so that the mere momentum of the motor, after the current has been shut off, and with the car standing, is able to start it and to propel it some distance. Provision has also been made for securing the pedestals of the car so that the wheel base can be slightly increased to take up any stretch in the sprocket chains which may occur.

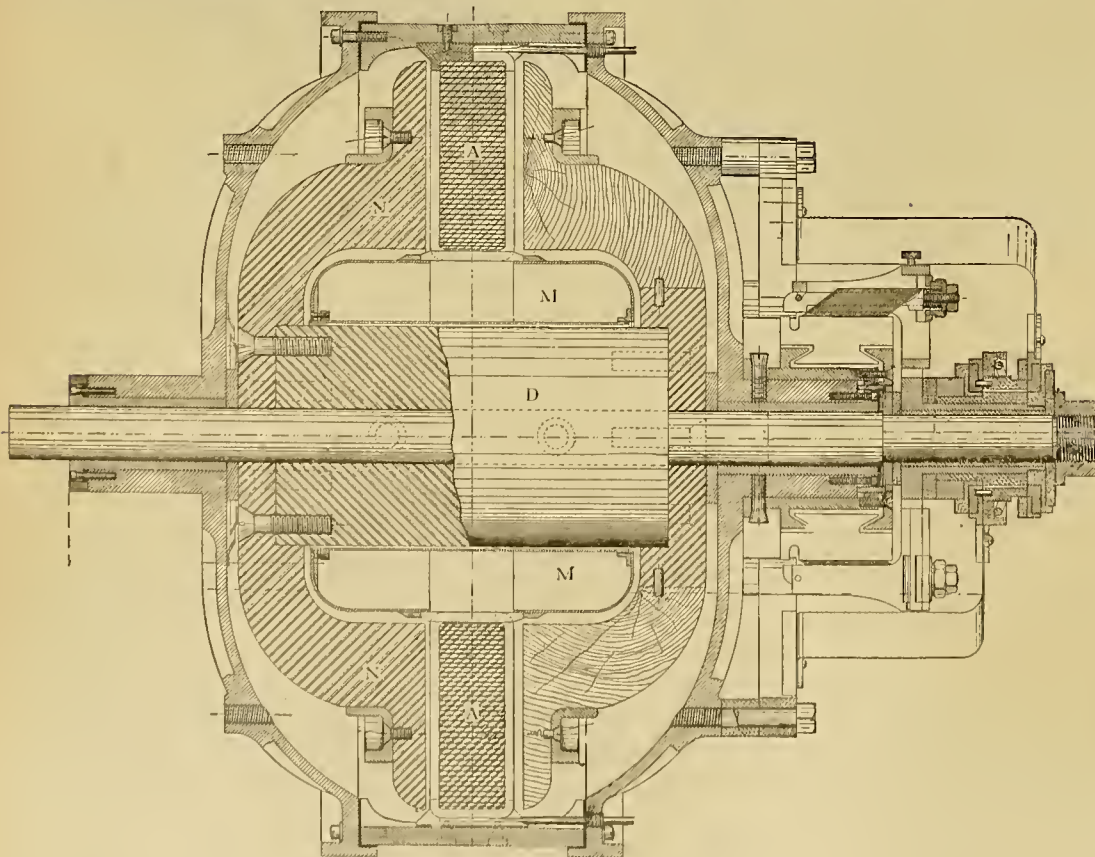

FIG. 7.—SECTION OF MAIN MULTIPOLAR MOTOR.

*A*, travel through and along it for the distance of one-fourth of its circumference and then pass out to the other side into the south poles and back through the core to the other side again.

"The armature is built up of specially rolled soft ribbon iron, wound spirally, the different

plished without shock. This has been accomplished by the employment of a peculiar gear, which is placed upon the sun and planet motion, with some essential modifications. The central shaft of this gear, which is directly connected to the motor, revolves at all times with the speed of the latter. Two portions of this shaft, how-



"These constitute the principal elements of the car, but it remains still to describe the method employed for taking out and replacing the discharged cells from the car. The arrangement employed for this purpose is illustrated in perspective in Fig. 9. Parallel with the track on each side of the car, as shown in the illustration,

system, and the results already obtained with the car now in operation are of the most encouraging nature, and have attracted the general attention of street railway people, especially those engaged in work in towns and cities where the feeling against overhead wires is strong."

Every test that has been made with the battery

The Sprague Motors in the Land of the Dakotas.

"On the mountains of the prairie,  
On the great red pipe-stone quarry,  
Gitche Manito, the mighty,  
He, the Master of Life, descending,  
On the red crags of the quarry  
Stood erect, and called the nations,  
Called the tribes of men together."

Nothing could be more novel than to find, on a late exploration to the red crags of the Big Sioux River at Sioux Falls City, that the Sprague system had, at a cost of \$75,000, spanned the "mountains of the prairie," thus connecting the city with its suburban quarries at East Sioux Falls, eight miles away. Our first view of the system was at the quarry end, and, being foot-sore and weary from clambering over the red crags, our eye caught the outline of a Pullman palace motor, with its peculiar civilizing effects, as it stood in the narrow valley inviting us to a much needed rest. In many a trip up and down, over the hills and through the valleys we firmly resolved never again to question the ability of "the Sprague" to climb anywhere. It is not necessary to mention the pride with which the people of Minnehaha county speak of their pet suburban line.

Whence comes it that when, with only a decade of city life, this city of the Falls can indulge in the luxury of a Sprague and a Pullman? The answer is, that aside from the wonderful energy and enterprise of this peculiar people, they have, within their county of Minnehaha, a vast source of wealth, unaffected by the ordinary or extraordinary changes in the climate incident to all lands lying in or near the 101 line of west longitude. We refer to the quartzite-jasper building stone, the products of which are, in the "best seasons," dangerously near the heart of the steam railway manager, and in off years they are the main reliance upon which the "turning of the wheels" so safely depends. Even the realization of the fondest hopes of the Dakotas, irrigation, must in this particular county always be second to the quarry interests. W. L. S. B.

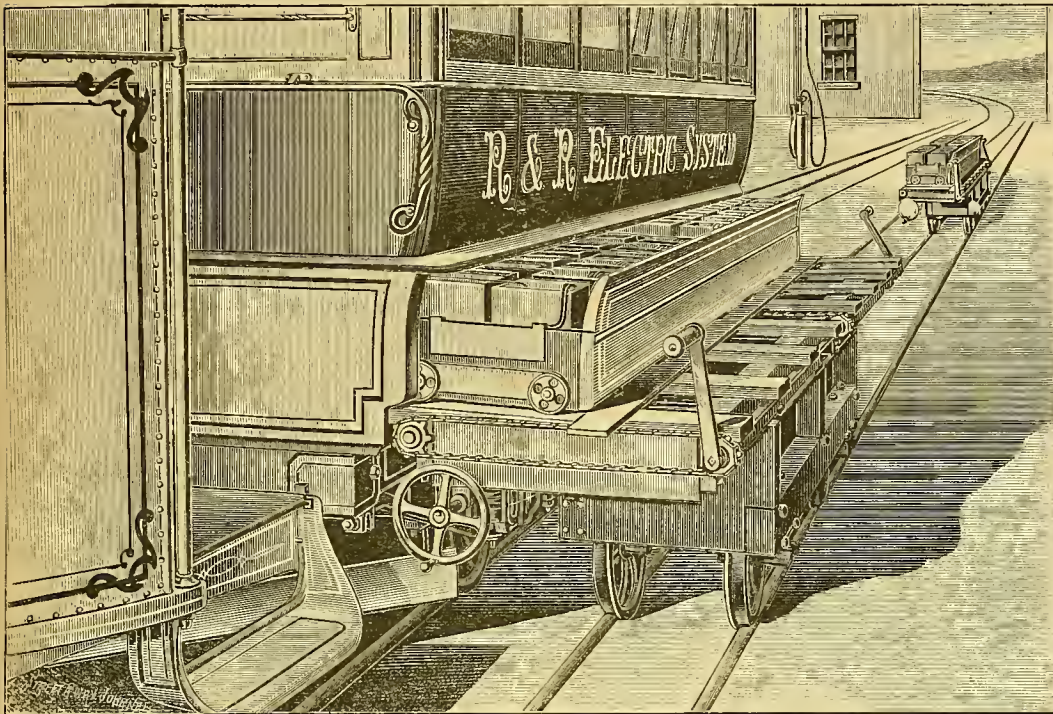

FIG. 9.—RIVER AND RAIL SYSTEM. METHOD OF CHANGING BATTERIES.

are narrow gauge tracks, on which a small platform car runs, the height of which may be regulated by means of the handle o, shown in detail in Figs. 10, 11 and 12. It will also be noticed that the battery cells are mounted in trays provided with wheels and fitted with latches to hold the cells in place. On top of the shifting table there is placed an iron bar extending along the entire length; the front of which, as shown in Fig. 12, has raised pieces so spaced as to come opposite the latches in the trays so that when the bar is brought up under them the latches are raised and the cells can be rolled out directly upon the platform. To remove the batteries at the same time these projections enter into engagement with shoulders on the latches and by means of the cranks, s s, shown in Fig. 12, and in perspective in Fig. 9, the entire series of cells can be drawn out at once. It will also be noticed that the cover panels of the car are removed with the cells, constituting, in fact, one side of the tray, a proceeding which is entirely permissible on account of the construction which is employed. The cells are immediately placed in circuit for recharging by flexible wires connected with copper bars above, which slide in slotted tubes, to the generator. Connection may thus be made with the cells at once and the cells wheeled off without delay.

and the car has been successful, and it certainly looks as though by reason of the invention, that the storage battery advocates should feel decidedly encouraged.

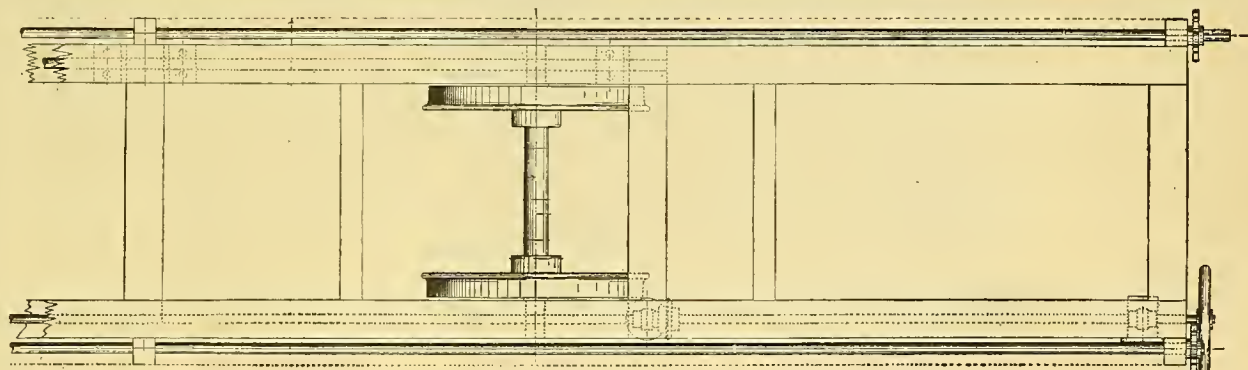
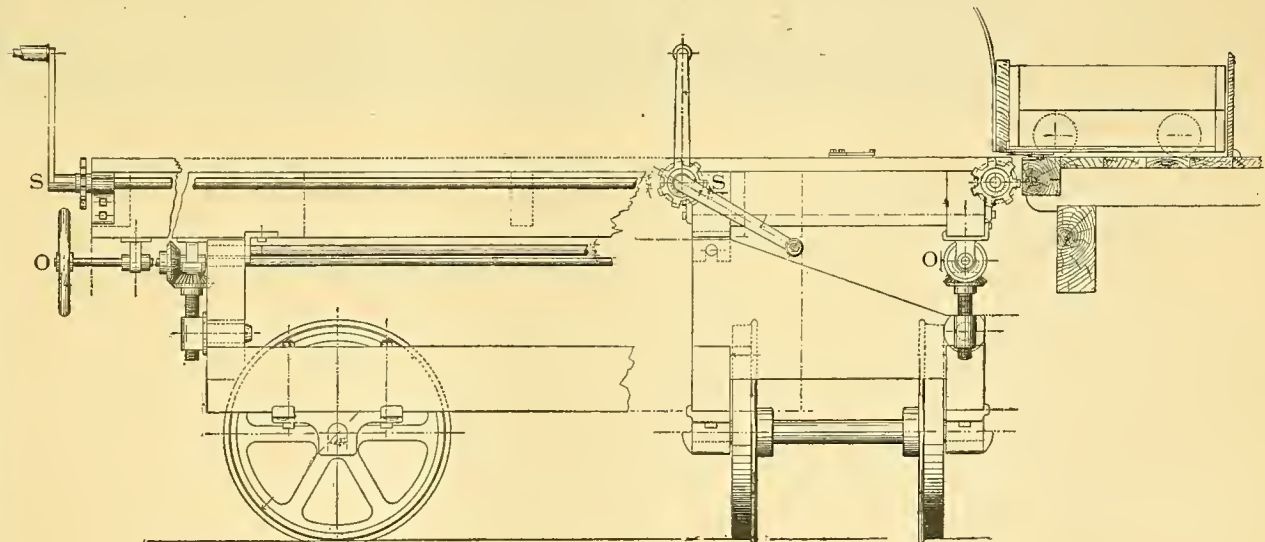

FIG. 10.



FIGS. 11 AND 12.—DETAILS OF BATTERY SHIPPING TRUCK, RIVER AND RAIL SYSTEM.

"Prof. Main has devoted a large amount of attention to the working out of the details of this

The Short Electric Railway company has received an order for the partial electrical equipment of the Syracuse & Onondaga Railway at Syracuse, N. Y.

The Muskegon Railway company has ordered from the Short Electric Railway company, three more motor trucks, one to be equipped with 36 inch wheels for a high speed car.



### The Short Electric Railway Company's Line at Pittsburgh, Penn'a.\*

We publish in this issue two views showing the Short Electric Railway company's cars, which have been in successful operation since the 4th of July upon the Oakland Branch of the Pittsburgh Traction company line. The line is about two miles in length and has some of the most difficult grades and curves to be found on any road in the United States. There are some six or eight right angle curves of from 30 to 45 foot radius, and one curve of 120 degrees with only 30 foot radius. There is scarcely a level piece of track on the whole road, and the grades vary from 2 to 7 per-cent. There is one 65 HP. Short generator at the station driven by a Bali engine of 100 HP. capacity, and a standard switch board commonly used by the Short Electric Railway Co. The dynamo and engine are placed in the power station of the Cable Railway Co. on Fifth avenue, the engine receiving its steam from the same boilers as the cable engines. The attention required to operate the electrical station is by this arrangement reduced to a minimum, and the only extra expense to which the company is put for operating this road is for one engineer during the day and one at night.

Although the engine and generator were both new when they were started on the 4th of July, they have never had to be stopped for any cause. The motors have done their work equally well. Each car is provided with a standard Bemis truck and two 15 HP. standard motors of the Short type, and they run with but little noise, which is due to the fact that the cars are equipped with the insulated wooden web gears controlled by this system. Each car makes a round trip on this road every fifteen minutes, and they often gain on their scheduled time. The cars are elegant in appearance, and each car carries from 500 to 800 people every day, showing that the line is thoroughly appreciated by the public. The line construction is very neat, handsomely painted octagonal wooden poles being used, and a single wire only is stretched over each track throughout the entire extent of the line. Much of the street is nicely paved

with block stone, and altogether the road is one of the most successful now in operation, both from a mechanical and financial point of view.

#### The Milliken Patent Pole.\*

These poles are formed of four sections of iron of the Phoenix shape, riveted together, with tie plates placed equi-distant and with lacing inserted at the point of greatest strain, a taper being given in that direction as shown in the cut of the pole designed for the side of the street. This method of construction gives a pole having very great strength in proportion to the weight of material used. Poles of this type are very light, durable and cheap, and their construction being open work, present a very pleasing appearance to the eye, while the inside can be painted and preserved indefinitely from the action of the air.

The center pole, for use between the tracks,

\* Milliken Bros., New York City.

has its longest diameter parallel with the rails; and when arranged with an ornamental top and lamps, makes a very artistic pole. The cross arms can be made separate from the pole if so desired for shipment, and bolted on after it is set in the ground. A cast-iron bumper to keep wagon wheels from striking the pole is provided at the bottom, made in two halves, bolted together on the inside and can be filled with concrete as shown in the cut if desired.

#### "Okonite."\*

Okonite is the name applied to a compound for insulating aerial, underground and submarine cables, also telegraph, telephone, electric light and, when needed, electric railway wires, and the article as now manufactured is the result of many years of costly experimenting and testing, its exact composition being known only to the makers. Rubber enters largely into its manufacture. As the compound is put on the wire before vulcanizing, being then vulcanized in position, a perfect evenness of covering is necessary and is obtained in a very ingenious way.

On one of the long tables in the covering room are smoothed out long strips of thinly rolled pure tin, fourteen inches wide. These are

chined, so that the wire and covering may be allowed to feed out without appreciable tension. At the covering machines they come together and pass through dies, the wire being thereby so thoroughly wrapped around by the Okonite and its tin backing as to make the covered wire look like a wire of tin several sizes larger, so perfect is the covering. After the wire is covered it goes into the vulcanizing oven, where it is subjected to a temperature of 275° for an hour, the heat being effected by turning the steam directly into the vulcanizers. After vulcanization the tin wrapper is removed from the Okonite covered wire, this being accomplished by a machine specially designed for the work.

The labeling machine is a very ingenious, but remarkably simple device. By a rotary movement it binds any number of wires into a solid, well-insulated cable. If this cable is to be armored, as is the case in the work of electric light, submarine use and submarine telegraph cables, where many conductors are cabled together, it then passes to the arming machine, where any number of strands of galvanized wire desirable or required is put around it. From this machine the cable is wound directly on large drums ready for shipment. Over 175 braiding



ELECTRIC CARS IN PITTSBURGH. SHORT SYSTEM.

brushed over with a thin varnish, to insure perfect freedom from any dust or dirt and to prevent the compound from sticking to them. Over these strips the Okonite is rolled out to entirely cover the tin to the size to which it is trimmed, making a long smooth band of Okonite with a thin tin backing. These bands are then drawn through a cutting machine, by which they are cut into narrow tape-like strips and automatically wound upon a reel with many divisions. Thus prepared, the tape like sections being afterward joined to their ends the whole are placed on a single reel, the Okonite is ready for use in covering the wire. The reel carrying the tin-backed narrow strips of Okonite, its width and thickness of Okonite being dependent on the size of the wire to be covered and its intended use, is then mounted to feed out in connection with another reel or drum carrying the wire, these reels being located some distance from the covering ma-

\* Okonite Co., New York City.

chines, manipulated by female operators cover the Okonite insulated wire with silk braid or cord, when it is to be used for inside incandescent lighting. In the testing room of the Passaic factory an electrical expert and four assistants are continually at work testing all Okonite wire by the aid of delicate Thomson galvanometers, before it is shipped from the establishment, thus rendering it almost a matter of impossibility for a piece of defective insulated wire to get beyond the testing room.

The demand for this famous insulating compound has far exceeded the manufacturers facilities for its production, and its works have been repeatedly enlarged, only to find a greater accommodation still imperative. Some months ago work was commenced on a new factory at Passaic, N. J., which is now completed, and which passes into the hands of the International Okonite company, a company recently organized, and which has bought out the interests of The



Okonite Company of New York, and the business of Messrs. Shaw & Connelly, the wire manufacturers of Manchester, England, and we understand that Okonite will be manufactured abroad as soon as the necessary machinery can be procured.

The factory at Passaic is a three-story brick building, 38x60 feet with wing 50x120 feet, and engine and boiler room 80x50 feet adjoining. There are also carpenter, machine and blacksmith shops on premises; the entire group of buildings and plant cover an area of about six acres.

Four hundred or more hands are employed, who turn out about sixty miles of insulated wire per day. Water-power, furnished by the Dundee canal, on which the factory is situated, is used to drive the machinery. In case the water-power from any cause should fail, an engine of 250 H. P. proves an effective substitute. In the engine room are located the dynamos for lighting the factory. The establishment is under the supervision of F. Cazenove Jones, superintendent, and Chris. Klotzbach, assistant superintendent.

Aug. 14th, 1890.....	60 90
Aug. 15th, 1890.....	52 65
Aug. 16th, 1890.....	57 55
Aug. 17th, 1890.....	116 00
Aug. 18th, 1890.....	164 50
Aug. 19th, 1890.....	89 45

\$68.76 per day. 3 cars. \$1581 55  
(Signed) S. E. ALLEN.

Average car mileage per day, 114.

Road has been in operation more than a month without any charge for repairs.

**A New Curve Insulator.\***

The successful and economical operation of electric railways depends on the proper line construction, i. e. on ample strength of all the parts



put under strain, and thorough insulation to the trolley wire from the ground. Owing to the weight of the trolley wire the supporting devices must be very strong, yet they must insulate the

not show this sleeve, but it shows the disposition of the iron and rubber parts, which are made unusually strong and promise to withstand the severest practical tests. Besides, the saving in fuel owing to the increased insulation, will be quite an item against the forms heretofore used.

THE Pullman's Palace Car Co., Chicago, is building:

Sixty electric cars for the Duquesne Traction Co., of Pittsburgh, Pa. These cars will be a little over 29 feet in length, equipped with double trucks, and to have a cab at front end for the protection of motor man.

One car body for the Sperry Electric Co., of Chicago, to be about 32 feet in length, equipped with their system.

Twelve closed electric cars for service on the Cicero & Proviso Electric Railway of Chicago. These cars are being adapted to the Sprague system and are to have double trucks.

Ten closed electric car bodies for the Sioux City Street Railway company, of Sioux City, Iowa.

Ten closed electric car bodies for the Multnomah Street Railway Co., of Portland, Ore.

One closed electric car body for the Willamette Bridge Railway Co., of Portland, Ore.

Twenty-four combination open and closed electric cars, with double trucks, for the Tacoma Railway & Motor Co., of Tacoma, Wash.

One open and two closed electric car bodies for E. E. Chase, for service in Fort Worth, Texas. Double trucks are to be applied under this equipment. The open car is to be 35 feet and the closed car about 33 feet in length.

Fifteen closed motor car bodies for the Toledo Consolidated Street Railway Co., of Toledo, Ohio.

Twenty-five closed motor car bodies, 25 feet in length, for the West End Street Railway Co., of Boston.

Forty electric cars for the Pittsburgh, Manchester & Allegheny Road, of Pittsburgh, Pa., which are to be practically the same as those they are building for the Duquesne Traction company.

Three closed trail cars for the Elgin City Railway Co., of Elgin, Ill.

In addition to the above, it has recently built and shipped

eight closed electric car bodies to the Rapid Transit Railway Co., of Newark, N. J., and two open trail cars to the South Dakota Rapid Transit Street Railway company, of Sioux Falls, S. D.

WORK on the connecting link between St. Paul and Minneapolis, is under way. A large number of delegates to the Edison convention took trips over the different electric lines of the city, and expressed great satisfaction on the working of the system.

THE North-West Thomson-Houston Co., of St. Paul, make a very fine exhibit of stationary motors of different types at the Exposition building. Work is progressing rapidly on the different electric lines of St. Paul, and when completed will cover some 150 miles of track. This will make Minneapolis the leading city in the United States, if not in the world, in electric railways.



ELECTRIC CARS IN PITTSBURGH. SHORT SYSTEM.

FROM the Edison General Electric company, New York:

WINSTON, N. C., Aug. 19th, 1890.

STATEMENT STREET CAR RECEIPTS.

July 16th, 1890.....	\$ 57 25
July 17th, 1890.....	98 95
July 28th, 1890.....	129 35
July 29th, 1890.....	43 35
July 30th, 1890.....	55 85
July 31st, 1890.....	43 00
Aug. 1st, 1890.....	43 65
Aug. 2nd, 1890.....	41 00
Aug. 5th, 1890.....	62 80
Aug. 6th, 1890.....	43 30
Aug. 7th, 1890.....	44 00
Aug. 8th, 1890.....	83 50
Aug. 9th, 1890.....	38 25
Aug. 10th, 1890.....	66 10
Aug. 11th, 1890.....	92 55
Aug. 12th, 1890.....	47 35
Aug. 13th, 1890.....	50 25

trolley line from the supporting wires. This is the more true at curves, where the same strain which is too much for an ordinary iron pole, is put on the single center curve insulator. It is not surprising that some of the forms now in use have not withstood so severe a test in practice, and have either lost their insulating properties or have partly crumbled up. Such a fate seems impossible for the new form which we illustrate above, the "Treble" Center Curve Insulator designed by Wm. Sharp. This is made of iron pieces bolted together and insulated from each other by hard rubber washers and bushings. As the cut shows, the three rubber bushings are in series, giving a treble insulation. A rubber sleeve fitting snugly over the insulator keeps this dry, so that the threefold insulation is obtained in all kinds of weather. The sleeve, by enclosing the insulation, also prevents any possible deterioration of the same. The cut does

\* Great Western Electric Supply Co., Chicago.



### Improved Water-Tube Steam Boiler.\*

Street railway men, operating mechanical power, will be interested in this boiler, which consists of a nest of inclined water-tubes connected at their front and rear ends with a series of horizontal overhead drums, the water level being carried at the middle of the drums, with the fire applied under the front and raised ends of the tubes. The action of the fire is to cause an upward and forward flow in the tubes, the water thus forced from the tubes into the front end of the horizontal drum being constantly replaced by a downward flow from the rear end of the drum to the rear end of the tubes; there being therefore, a steady continuous circulation of all the water throughout the boiler, and the steam being disengaged into the upper portion of the horizontal drums. The tubes are expanded in pairs at both ends into bored holes in cast iron headers, and when in place they are in identical conditions as regards exposure to flame, temperature of contents, etc., so that the expansion and contraction of both must be uniform. One horizontal drum with its underlying row of headers and the tubes therein, forms a separate "section" of the boiler; and it should be noted that the rows of headers at the front and back of each section, with the bends connecting them, form, at each end of the section, a single header through which the ends of the tubes in that section are all and individually connected to the ends of the overhead drums. In this manner the connections are made between the tubes and the drum to provide for the circulation of the water. For the purpose of equalizing the pressure and water level, as well as to supply feed water and take away the steam, the several sections are all connected to a common cross steam pipe and a common mud drum, located at the rear or rigid end of the boiler. From the common steam pipe two outlets connect with an overhead cross steam drum, of ample capacity, to which are attached the main stop and safety valves. This drum is provided with a drip pipe leading below the water line so that condensation, if any there be, may drain back into the boiler. The path of the downward circulation in large boilers is from each overhead drum through its connected down-take, into the common feed drum, from this through the stand pipes to the mud drum, and from the latter the water is distributed to the lowest headers of all the sections. The object of this arrangement of feed drum and stand pipes is to heat the entering feed water by mingling with the descending currents from the overhead drums.

The boiler is enclosed in brick work, the headers, which are milled on their sides, forming the front and rear walls of the combustion chamber. A brick wall at the rear encloses the mud drum and the rear end of the boiler, so as to prevent undue radiation, and a chamber is thereby formed between this wall and the rear headers, to which access may be had at all times even with steam up. An ornamental cast and wrought iron front is provided with the boiler, as are doors and frames for access to all parts for inspecting and cleaning purposes. These boilers are recommended as absolutely safe, as highly economical in the use of fuel, as giving dry steam, as being fully up to the rated capacity, as being very durable and easy to keep in order. They are specially well adapted for use in street railway power plants.

### Double Fusible Safety Box.†

This fusible cut out box is 6 inches square by 4 inches deep and is located on the outside of car beside pilot light. It contains two separate plugs or safety strips one having an ampere capacity of 45 and is the one normally used, the other 65 amperes. It is claimed for this box that the chief advantages are as follows:

It is a protection to armatures, inasmuch as it prevents current in excess of ampere capacity from passing through motors, which is now liable, through faulty insulation, or short circuit. Should both plugs "blow" one after the other the car must be towed in and inspected. No other than fusible wire should be placed in the box lest the plugs in station are blown and entire line stopped.

It confines trouble on any one car to that one

\* Abendroth & Root Mfg. Co., New York City.

† Chas. M. Rumrill, New York City.

only, and does not interfere with the rest of the line. The readiness with which another plug is put in circuit by the throwing of a switch, handily placed, can be fully appreciated by street railway men. It has a mica front through which the plugs are seen, thus showing at a glance that plug is "blown." It is a cut out box when its handle is in central position. Lamps remain lit even when plugs are blown. This is important at night, especially when plugs have been melted by lightning. It is an extra precaution against runaway car. When drivers do not leave the car without the handle being in a central position. The fuse is easily replaced. At any convenient time the driver can replace the blown plug, first putting the handle in a central position. If the platform is dry the same result can be accomplished when in circuit and car running.

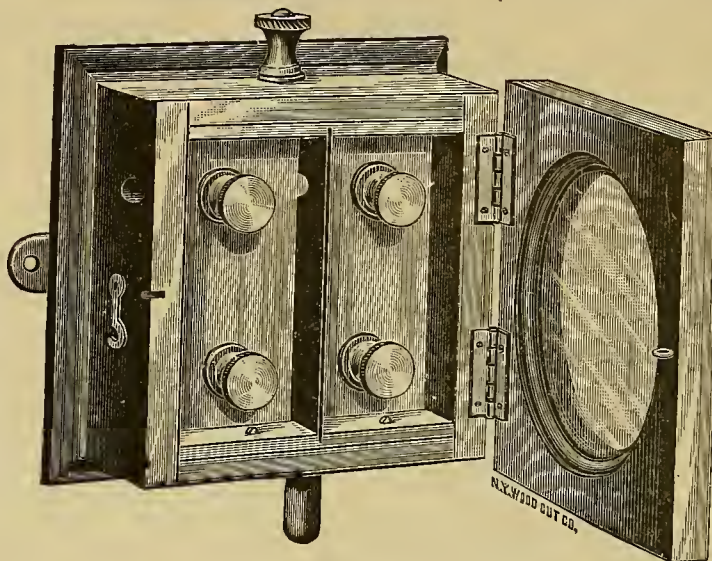

DOUBLE FUSIBLE SAFETY BOX.

The *Transactions of the American Institute of Electrical Engineers*, of which we have received the pamphlets covering the months of June and July, are an important factor in spreading the information gained by thorough and searching investigations into the various phenomena encountered in the commercial use of the electrical force. The papers contained in these numbers have a practical bearing on some

plies, and doing the work with the assistance of unskilled natives. In rehearsing his troubles and the means used to overcome and avoid a repetition of them, he gives many little practical points that would be of value to the superintendent of a plant in times of trouble.

Mr. Louis B. Marks' paper on the Life and Efficiency of Arc Light Carbons, is the record of numerous tests of carbons purchased in the market and tested with a view to determining the qualities of carbon most suitable for the currents commonly in use as well as the potential and amount of current from which the best results might be obtained. In determining these points microscopic examinations were made of the structure of the carbons. These are given in photo-engraved views with the results of the investigation. The paper contains many practical points and cannot fail to be of interest to all persons interested in arc lighting.

Practical Aspects of the Alternating Current Theory, by M. I. Pupin, is a very interesting paper treating of the practical application of Ohm's law and its derivations to the explanation of the phenomena of alternating currents, with brief references to the important discoveries in electricity and magnetism that have led to the extended commercial application of alternate currents. The induction of currents is very clearly reasoned out and several formulas made use of in the designing of alternate generators and induction coils are given. The paper is interesting and instructive.

A paper giving the magnetic data of the Sprague Street Car Motor, by H. F. Parshall, is replete with information.

Mr. Thomas D. Lockwood's paper on the industrial utilization of the counter electro-motive-force of self induction is a very clear exposé of the subject, as it gives the history of discoveries made in that line, and points out many ways in which the usually detrimental force may be utilized to great advantage.

Taken altogether the numbers of the journal are of great interest and value to electricians.

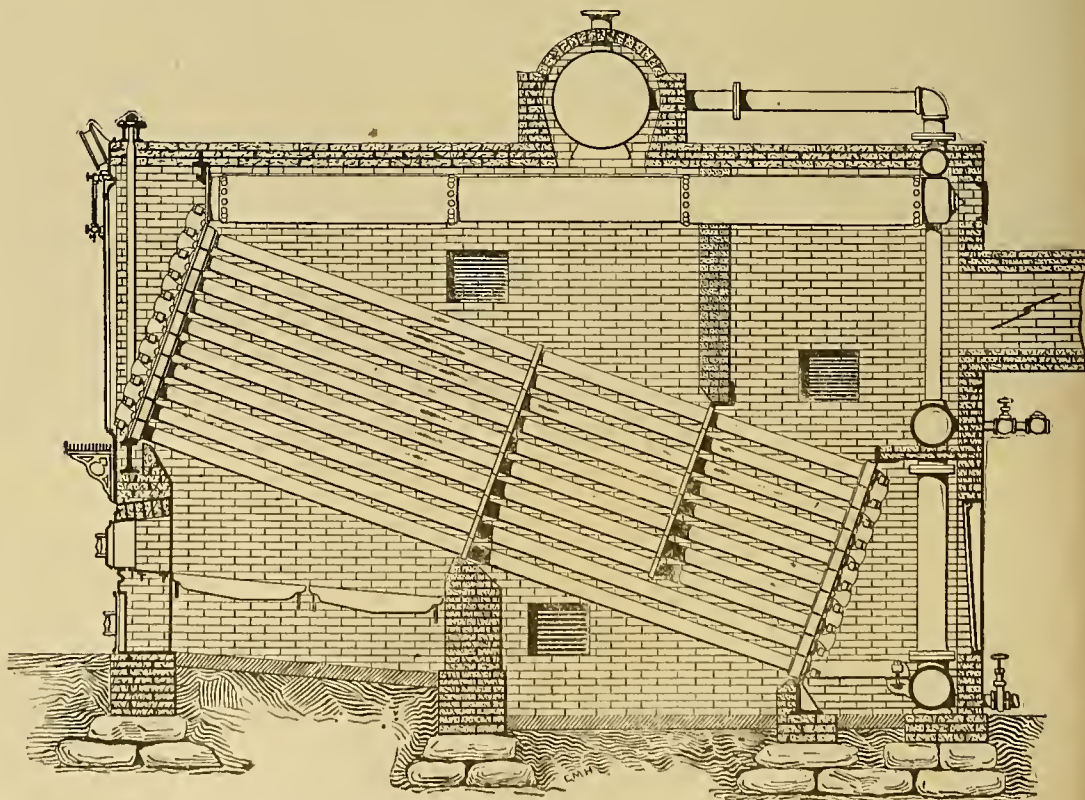

SECTIONAL VIEW, ROOT NEW WATER-TUBE STEAM BOILER.

of the most important points in electrical applications. In the paper on Electric Lighting in the Tropics, Mr. Wilfrid H. Fleming tells of the many difficulties encountered in establishing and maintaining an electric lighting plant, when at considerable distance from the base of sup-

The journal is published monthly and furnished at an annual subscription price of \$5 per year.

HATHEWAY & ROBISON, Cleveland, O., have contracted for tracking the S. & O. St. Ry. Syracuse, N. Y.



**Ratchet Brake Lever.\***

It is generally conceded by street railway men, that the positive motion of a brake hand lever is preferable to that of the common brake windlass with its chain and brake handle or crank.

Heretofore the objections to the ordinary lever as a means of controlling the brakes have been: the inability to take up lost motion caused by the wearing of brake shoes and the loosening of joints; and that there is not sufficient length to the ordinary car platform for the sweep of the lever handle.

These objections are entirely overcome by the patented ratchet brake lever as illustrated above.

It can be used for operating not only the wheel brakes, but also the track brakes and cable grips as well.

Fig. 1 represents the lever when brakes are released.

Fig. 2 shows the lever when brakes are applied with ratchet segment thrown forward to full extent.

Fig. 3 is a top view and shows the small amount of platform floor space occupied by the lever.

The device consists of the following parts. Fig. 4. A lever with single pawl attached; Fig. 5. A ratchet segment which is pivoted at the lower end of the lever; Fig. 6. A double pawl which holds the ratched segment while the single pawl is taking

The leading features are: extended motion beneath the platform, admitting of increased power when there is a limited space on the plat-

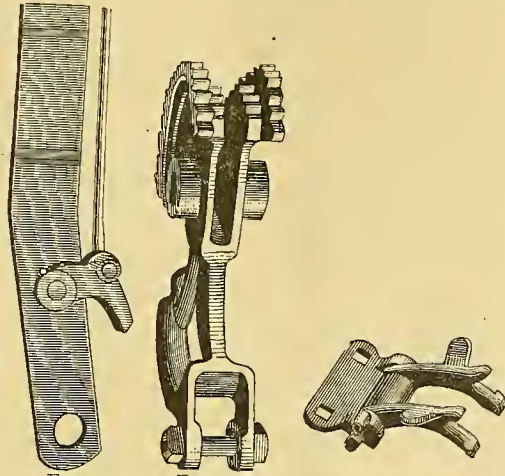

FIG. 4. FIG. 5. FIG. 6.

form for working the lever handle; quick and powerful application of the brakes in case of

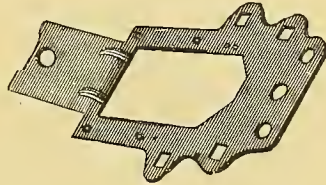

FIG. 7.

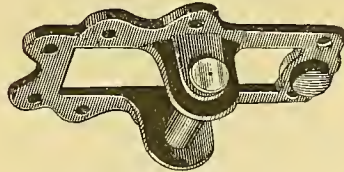

FIG. 8.

emergency; and compactness, as the working parts are under the platform and do not obstruct the top of it.

as they afford a permanent fire-proof channel or race-way into which the wires are placed, and in the event of the failure of any wire in the car, the defective wire may be withdrawn and a new one inserted in its place without disturbing at all the cabinet work within the car.

For underground work the company has developed a complete system which is a radical departure from the old method and is remarkable for its cheapness and the ease with which it can be laid.

The following has been received from John Stephenson Company Limited:

[Copy.]

EDISON GENERAL ELECTRIC COMPANY.

NEW YORK, Aug 25, 1890.

John Stephenson Company Limited.

DEAR SIR: Mr. Vail has referred to us your favor of the 23d inst, and we note with pleasure that the cars for the Elmira Road have all been shipped in good order.

I desire to express my appreciation of your promptness in this matter.

Yours truly,

(Signed) CHAS. D. SHAIN,  
District Manager Eastern District.

NOTE.—The order for the above six (6) cars was booked by "John Stephenson Company Limited" the evening of Wednesday, July 30. The material was taken from the stock room, the cars were constructed and completely finished, motors all attached, wiring done, trolley bridge in place, and they were shipped, in perfect order

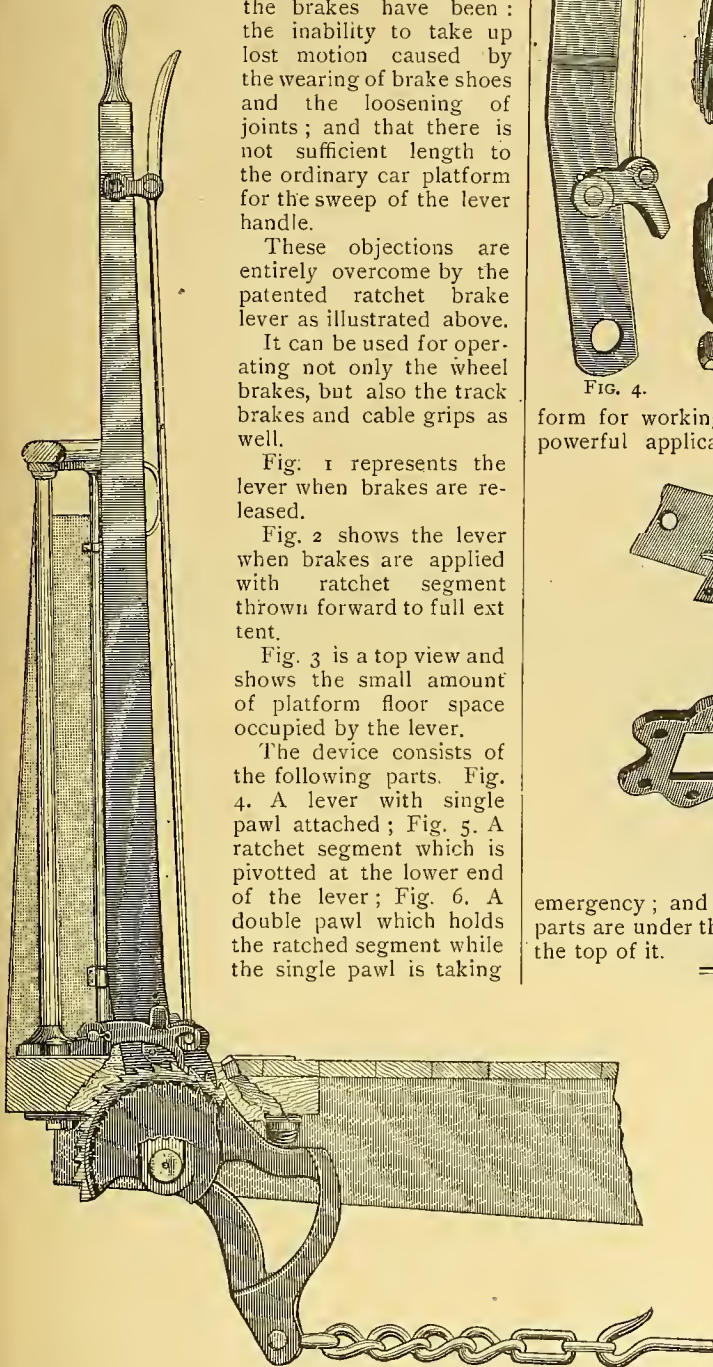

FIG. 1.

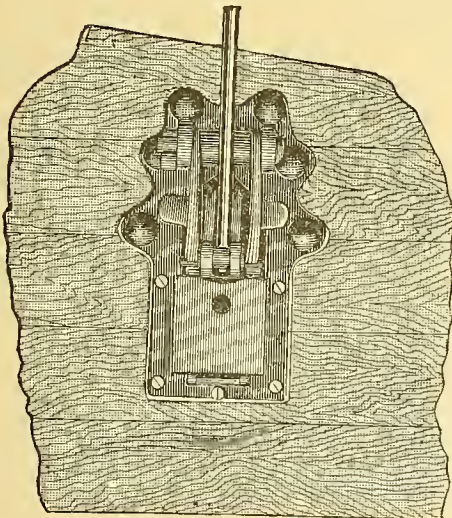

FIG. 3.

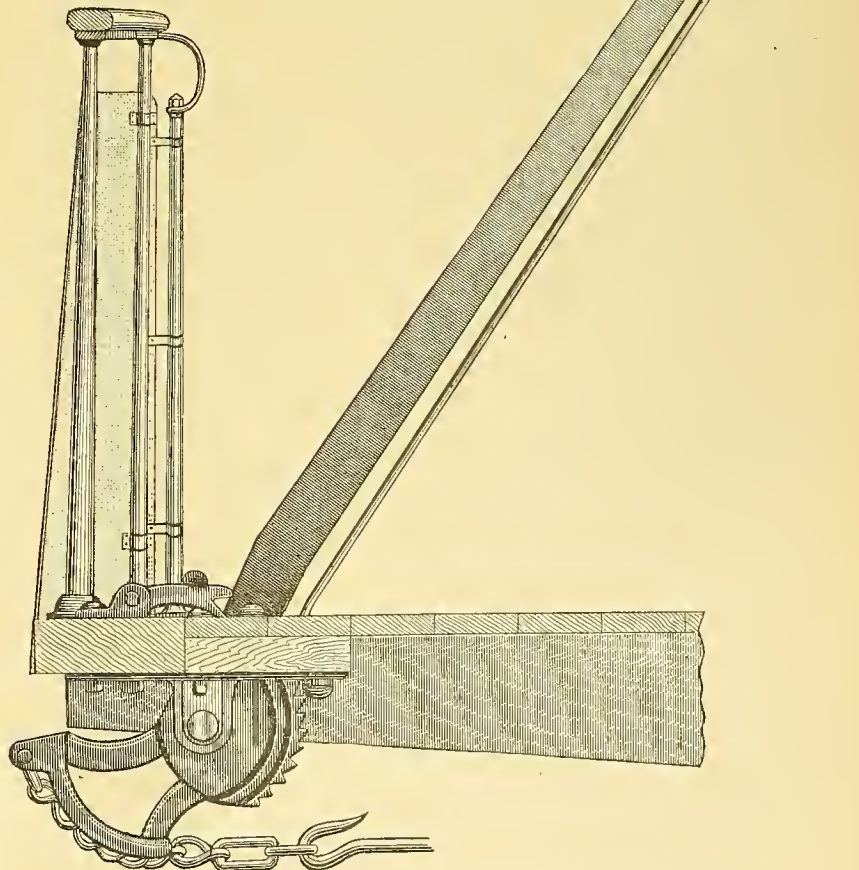

FIG. 2.

another hold; Fig. 7. A floor plate with hinged trap door; and Fig. 8 the lever fulcrum.

It is released by lifting the single pawl and throwing the lever forward.

**Interior Conduits.\***

These conduits are especially applicable to all electric railway requirements, the interior tubes being very useful for wiring the cars, inasmuch

for electric service, August 21, 22, 23, respectively, two cars each day. Aug. 25, Col. D. C. Robinson, president of the railroad company, announced by telegram the arrival of the cars at Elmira in good order.

\* J. C. Brill Company, Phila., Pa.

\* Interior Conduit and Insulation Co., New York.



### Their Ruling Passion Strong in Death.

ASHTABULA, OHIO, Sept. 12, 1890.

The street railroad war is the all absorbing topic of conversation, and the council committee are skirmishing all over the country to find anyone to build a street railroad here. Their success in finding such parties under existing circumstances is not very flattering. Mr. Stewart notified the Council at its meeting of Aug. 26th that any attempt at disposition of his franchise rights in the streets would be resisted by process of law, or by force of arms if the exigencies of the case demand such procedure, against any and all parties claiming to act for them or under their authority.

Failing to fully comprehend their position, and that there can be little doubt but what the courts will maintain that Mr. Stewart's road was illegally removed, and will re-instate him for the remaining eighteen years of his franchise, the official acts of the city council border largely on the ridiculous. At its last meeting a resolution was passed, setting forth some of the conditions which would be incorporated into any street railroad franchise hereafter granted. Among some of these we note that the "Johnson Girder Rail" shall be used, and paved between the tracks, "that none but electric roads shall be built, that cars shall be run every fifteen minutes, and the fare shall be five cents, and that five per cent. of the gross receipts shall be paid into the city treasury, and in case any of the conditions of the franchise are not complied with, the council may tear up and remove the roads from the streets, and no liability for damages shall follow." Thus, at the eleventh hour, assuming that a liability has been incurred in the destruction and confiscation of Mr Stewart's property, and that their "Ruling Passion" for such diabolical acts and assumption of power shall hereafter be allowed a shadow of protection, as they claimed to have this safeguard against Mr. Stewart while they were leading a howling mob on Sunday July 20, the beam appears only to have just fallen from their eyes.

—Justice.

### A Great Work Finished.

Seven miles of cable track completed and cars running. John D. Isaacs' concrete system is a success as illustrated on the Piedmont Cable Railway, connecting as it does, Oakland, the entrepot of the Golden Gate, with picturesque Piedmont. Mr. Isaacs seems to have solved the problem which for eighteen years has puzzled the financier and his faithful servants, the mechanical and civil engineers.

When cable railways cost \$100,000 per mile in 1880-1882, and \$72,000 in 1887, every one who travels on wheels along urban or suburban routes, has a debt of gratitude which he can hardly repay in an ordinary life-time, to the engineer whose thoughtfulness has made it possible to successfully complete a standard cable railway at a saving of \$20,000 per mile.—Justice.

THE Springfield Printing and Binding Co., Springfield, Mass., has just issued an artistic illustrated circular designed to represent the interests of our whole people in the 600 cubic miles of quartzite-jasper through which the Big Sioux river trends, in a southerly direction, through eastern South Dakota, with Sioux Falls City as a center. This stone is admirably adapted for pavements.

Complete Collection of Shoppel's Modern Houses, 1,500 illustrations. Co-operative Building Plan Association, New York. Price, \$10.00.

The contents of this interesting volume are fairly indicated by its title. The book is a handsome folio, very handsomely gotten up and contains perspective views, floor plans, detail drawings and estimates of a large number of houses of the most modern design ranging from the cottage costing less than \$1,000 to the palatial residence costing \$15,000. Those intending to build a home will find in this work not only a wide variety of plans from which to make selection, but also many useful hints in building matters. The price is merely nominal considering the vast amount and valuable character of the information given.

### The "Czar" Horse Shoe Cushion.\*

The "Czar" Horse Shoe Cushion is designed for the prevention and cure of lameness in horses. It is offered to horsemen, horse railway companies, horse owners and veterinary surgeons, as a remedy for many ailments of the feet of horses such as result from the jar and hammering received in traveling on paved streets and macadamized roads. Being elastic and placed between the hoof and the shoe, it is claimed that this cushion overcomes all concussion and that the horse is enabled to travel with greater ease than when shod by the old method. Some of the troubles which, it is claimed the "Czar" Cushion will prevent or cure are: Tender feet, corns, quarter cracks, sand cracks, split hoofs, hard, dry, brittle and contracted feet. The balling of snow, picking up and throwing dirt, gravel or snow in the face of the driver is obviated by these cushions, the beveled flange acting as a preventative. By the use of the "Czar" Cushion the feet are kept soft and pliable. It will not injure or prevent the growth of the frog, there being no pressure on the heel, as is the case with many devices covering the whole foot.



The accompanying cut represents the appearance of the cushion in the position under the horseshoe.

Street Railway Gazette, Chicago, Ill.

DEAR SIR: In reply to your inquiry I would state that the fire which partially destroyed our factory on Tuesday night, Aug. 26th, was started in our drying rooms, and after burning many thousand feet of green or untreated underground tube and effecting the destruction of our underground curing apparatus, was checked, so that the output of Underground Conduits will only be temporarily restricted. Having kept our original factory in West 27th street, on Interior Conduit Work, this branch of our business will not be interrupted, and with the aid of additional temporary factory facilities secured in that neighborhood we will be enabled to aid the Underground department materially.

The burned building will be immediately rebuilt and a new structure seven stories high will be added. This will more than double our present accommodations and enable us to keep pace with the extraordinary demand made upon us. Yours very truly,

INTERIOR CONDUIT & INSULATION CO.  
EDW. H. JOHNSON, Pres.

THE Electric Merchandise company, with offices and salesrooms at No. 11 Adams street, Chicago, has lately gone into the business of manufacturing and dealing in electric railway supplies of all kinds. Their descriptive catalogue gives illustrations of numerous devices and material required in the operation of any of the electric railway systems. Their facilities are complete for furnishing anything in this line from the smallest detail to the full equipment of an electric railway of any system. Their facilities for manufacturing are such as enable them to supply anything needed in the construction or maintenance of electric railway lines, on very short notice.

\* New York Belting and Packing Co., New York City.

### Patent Fire Felt.\*

Fire felt has attained wide popularity as a superior form of non-conducting pipe and boiler covering. In a recent catalogue issued by the manufacturers, we find the following regarding Fire Felt:

It is asbestos alone that possesses in itself every requisite of a non-conducting covering, and can be used without the intervention of any foreign materials, while it is in the pure or fibrous form of asbestos that the best results as a covering are obtained.

Fire Felt is the non-conducting form of asbestos. The pure fibres of this mineral are alone used in its manufacture. These are formed by a patent process into cylinders, blocks and sheets, according to the shape and size of the surface to be covered, and which differ from all products of asbestos heretofore manufactured, being exceedingly light in weight, pliable, and, therefore, adaptable to a surface of any shape; strong and tough on the exterior, so as to be handled without damage, but spongy and felt-like on the inner layers, insuring non-conducting qualities of a higher order.

When tested with paper pulp, hair felt, cork, sponge and the various composition coverings, the merits of Fire Felt are apparent. Not only does it give better non-conducting results, but the user has an absolute guarantee of durability.

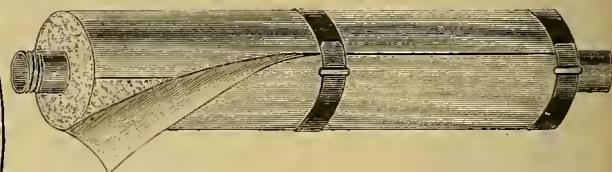

PATENT FIRE FELT WITH CANVAS COVER AND FLAP.

Fire Felt having no organic or perishable materials in its make-up, cannot char or burn out. It is thoroughly fire-proof and therefore very durable.

For all ordinary steam pipe work it is advisable to use the Fire Felt Covering, with canvas cover and flap, but for pipes, the material in cylindrical or sectional form, of a proper size to fit the pipe is recommended. Each section is three feet in length, and open on one side so as to spring over the pipe, suitably canvassed, and supplied with the necessary bands and fastenings for securing to the pipe. It can be applied by unskilled workmen, and when repairs are required can be removed and replaced without injury.

Where pipes are caused to jar or vibrate, Fire Felt will not crack or crumble, and should the covering be subjected to a chance knock, or be wet by an accidental flow of water, it will not be destroyed, and little or no repairing will be necessary.

SAN FRANCISCO, CAL., Sept. 12, 1890.

THE STREET RAILWAY GAZETTE.

Gentlemen:—Having recently completed the cable railways at Los Angeles, I have organized the California Contract Corporation for the purpose of establishing a general and comprehensive supply house on the Pacific Coast, and for the promotion, construction and equipment of street railways.

This Corporation is in communication with important financial syndicates in London and Berlin, and has authority to conduct negotiations for the acquisition or consolidation of established undertakings.

Respectfully yours,

J. C. ROBINSON, President.

J. H. HARBOUR, Secretary.

### The Chicago Exposition.

The Eighteenth Annual Exhibition of the Inter-State Industrial Exposition, opened at Chicago, Wednesday, Sept. 3rd, and is now running in full force, and complete in all its details. The art gallery and the mechanical and electrical departments are fully equal to, if they do not surpass, all former displays. The electrical department is especially worthy of attention, the electrical fountain being a special attraction. In the steam engineering line, several novel and interesting devices are shown, indicating the latest developments in this line.

\* Chalmers-Spence Company, New York City.



# NATIONAL Electric Light Association.

## Cape May Convention.

The twelfth convention of the N. E. L. A. was held at the Stockton Hotel, Cape May, N. J., on August 19th.

Among the members of the association and others who attended the convention, were noticed the following named gentlemen:

- Allegheny, Pa.—A. Groetzinger.
- Ansonia, Conn.—F. B. Platt.
- Atlanta, Ga.—John S. Alfred.
- Boston, Mass.—P. H. Alexander, G. L. Anstin, F. E. Barker, S. E. Barton, Capt. Wm. Brophy, A. N. Burbank, Louis W. Burnham, F. E. Cabot, H. J. Conant, H. E. Duncan, C. L. Edgar, H. H. Eustis, H. M. French, A. V. Garratt, C. M. Goddard, L. H. Hart, J. R. Lovejoy, A. F. Mason, E. C. North, R. F. Ross, F. E. Pettingill, A. C. Shaw, R. T. White, E. F. Woodman.
- Bridgeport, Conn.—W. C. Bryant, J. M. Orford, O. S. Platt, H. D. Stanley.
- Bristol, Pa.—Charles E. Scott.
- Brooklyn, N. Y.—E. F. Peck.
- Buffalo, N. Y.—C. Lee Abell, C. R. Huntley, W. H. McDonald.
- Chicago, Ill.—W. P. Adams, J. P. Barrett, John W. Blaisdell, Chas. A. Brown, E. V. Cavell, STREET RAILWAY GAZETTE; Geo. Cutter, J. W. Dickerson, "Western Electrician;" Fred Degenhardt, Henry C. Eddy, C. E. Gregory, W. A. Kreidler, "Western Electrician;" Geo. A. McKinlock, E. L. Powers, "Electrical Industries;" J. W. Shay, J. H. Shay, H. H. Small, Gilbert M. Smith, Ed. F. Williams, C. H. Wilmerding, H. S. Winston, F. A. Wunder, John Young.
- Camden, N. J.—Hon. E. A. Armstrong, J. J. Burleigh, C. L. Rodman, Heber C. Robinson.
- Cleveland, Ohio.—C. C. Curtis, W. B. Cleveland, J. B. Crouse, Benj. F. Miles.
- Colorado Springs, Colo.—E. C. Wade.
- Dallas, Tex.—W. M. Clower, C. O. Harris.
- Detroit, Mich.—Jessie M. Smith, Fred. Whipple.
- Elgin, Ill.—G. S. Bowen.
- Fitchburg, Mass.—H. F. Coggsball.
- Flint, Mich.—A. G. Bishop.
- Ft. Wayne, Ind.—W. R. Kimball, M. M. M. Slattery.
- Hartford, Conn.—W. G. Halm, C. L. Tolles, Francis P. Whiting.
- Kansas City, Mo.—M. E. Bates, G. W. Hart, Geo. H. Hageman, E. R. Weeks.
- Montreal, Que.—A. J. Corriveau.
- Newark, N. J.—C. O. Baker, Jr.
- New Bedford, Mass.—Charles R. Pine, Mr. Underwood.
- New Britain, Conn.—T. H. Brady, L. C. Whitney.
- New Orleans, La.—S. J. Hart.
- New Haven, Conn.—J. English, C. D. Warner.
- New York.—P. C. Ackerman, F. M. Adams, C. H. Barney, Oliver A. Brown, L. D. Beck, Dr. Louis Bell, "Electrical World;" W. Brackan, Edward Caldwell, Capt. W. L. Candee, Wm. W. Castle, Stephen L. Coles, Francis B. Crocker, W. F. Cullen, C. J. Field, G. H. Fisher, Wilfrid Fleming, A. R. Foote, R. E. Gallagher, E. T. Greenfield, J. W. Godfrey, R. J. Gray, W. H. Gordon, Wm. J. Hammer, Geo. H. Hartwell, H. M. Haines, W. J. Jenks, E. H. Johnson, W. J. Johnston, "Electrical World;" Jas. F. Kelly, Theo. Larbig, A. B. Laurence, H. Ward Leonard, E. W. Little, H. L. Lufkin, Gen. E. O. Madden, J. P. McQuaide, Frank A. Magee, Geo. T. Manson, T. C. Martin, "Electrical Engineer;" George H. Meeker, T. McConbray, W. E. Morrison, E. Myerson, Geo. M. Phelps, "Electrical Engineer;" Geo. B. Prescott, Jr., C. W. Price, "Electrical Review;" S. Rosenstamm, R. W. Ryan, John A. Seely, L. W. Serrell, Ralph L. Shainwald, H. L. Shippy, C. W. Spear, H. L. Storke, C. E. Stump, "Electrical World;" H. M. Swetland, "Power;" J. B. Taltavall, Robert Taber, Wm. H. Temple, "Western Electrician;" J. Van Gestel, C. S. VanNuis, F. Warder, Jean A. Wetmore, Benj. R. Western, Jos. Wetzel, "Electrical Engineer;" Schuyler S. Wheeler, G. L. Wiley, Harry W. Williams, E. E. Wood, F. P. Wisner, C. G. Young.
- North East, Pa.—A. L. Daniels.
- Orange, N. J.—Chas. Wirt.
- Philadelphia.—Henry N. Almy, C. A. Bragg, A. Bouneville, David Brooks, H. A. Cleverly, D. O. Conner, W. A. Drysdale, A. J. De Camp, F. H. Deacon, Wm. Hazellon, 3rd W. F. Hanks, W. R. Hood, Norman Marshall, W. McDevitt, W. C. McIntyre, Alfred F. Moore, Geo. F. Porter, O. D. Pierce, H. S. Smith, T. C. Smith, W. A. Stadleman, W. H. Shoemaker, G. A. Wilbur, Elmer G. Willoung.
- Pittsburgh, Pa.—H. L. Angloch, S. A. Duncan, A. E. Carrier, J. W. Marsh, Morris W. Mead.
- Plantsville, Conn.—H. C. Roberts, J. R. Stagg.
- Pottstown, Pa.—Chas. E. White.
- Pt. Huron, Mich.—W. F. Davidson.
- Providence, R. I.—Marsden J. Perry, Geo. H. Wood.
- Rutland, Vt.—M. J. Francisco.
- San Francisco, Cal.—Geo. H. Rowe.
- St. Louis, Mo.—Robt. McMath, C. C. Moffit, Russell Parker, D. R. Russell.
- Toledo, O.—C. R. Faben.
- Trenton, N. J.—F. A. Perrine.
- Waterbury, Conn.—A. M. Young.
- Wilmington, Del.—H. B. Cobb.

Windsor, Conn.—M. E. Baird, A. D. Newton. Washington, D. C.—A. M. Renshaw, F. W. Royce, Worcester, Mass.—H. M. Smith.

Quite a large number of ladies honored the convention with their presence, among whom we note the following:

Mrs. P. H. Alexander, Miss E. W. Armstrong, Mrs. G. L. Anstin, Mrs. C. O. Baker, Mrs. C. H. Barney, Mrs. J. P. Barrett, Mrs. S. E. Barton, Miss Myrtis Barton, Mrs. Charles A. Bragg, Mrs. J. J. Burleigh and two daughters, Mrs. W. L. Candee, Mrs. Wm. M. Castle, Mrs. George Cutter, Mrs. A. J. DeCamp, Mrs. C. R. Faben, Miss M. B. Ford, Mrs. M. J. Francisco, Mrs. R. E. Gallagher, Mrs. Harris, Mrs. G. W. Hart, Mrs. E. H. Johnson, Mrs. W. J. Johnston, Mrs. J. F. Kelly, Mrs. W. R. Kimball, Mrs. and Miss Eugenie Lenox, Mrs. E. W. Little, Mrs. W. C. McIntire, Mrs. J. P. McQuaide, Mrs. George T. Manson, Mrs. A. F. Mason, Miss Kate Mitchell, Mrs. J. M. Orford, Mrs. F. E. Pettingill, Mrs. G. B. Prescott, Jr., Miss Ridlon, Mrs. John A. Seeley, Mrs. M. M. Slattery, Mrs. W. A. Stadleman, Mrs. C. D. Warner, Mrs. E. R. Weeks, Mrs. Schuyler S. Wheeler, Mrs. Fred Whipple, Mrs. George H. Wood, Mrs. John Young, Mrs. A. M. Young.

President Marsden J. Perry opened the proceedings with the following address:

You are here to-day to erect, by mutual action, another milestone—in the form of the volume that will be created to contain a record of your proceedings—to mark the progress the development of the electrical industries. Short as the history of this development is, it has been so crowded and broadened by the eager enterprise that is characteristic of our people, that no records are to-day sufficiently ample and complete to give any of us a correct knowledge of the present condition of the multitude of undertakings employing electricity in some form of practical application.

To supply this deficiency a "Memorial and Statement" has been presented to Congress in the name of this association, urging that the fullest possible investigation and report be made on the electrical industries by the eleventh census. This association can do no more important work for the interests it represents than to select from the census reports certain points of inquiry, and adopt measures to keep them continuously written up to date. Recommendations looking to this end may be presented by the committee on data.

As a general statement it may be assumed that there is to-day a central lighting and power station in operation in every town of any importance in the United States. An estimate made by, and published in, the August number of *Electrical Industries* makes the following showing:—

Number of stations.....	1,379
Capital invested.....	\$118,758,500
Number of arc lights.....	127,441
Number of incandescent lights.....	1,590,967
Engine capacity, h. p.....	356,755

Elloquent as these figures are of enterprise and progress, they tell but part of the story. One startling omission is that of the electrical transmission of power for stationary and locomotive work. The statements, however, may serve the purpose of helping the imagination to picture the results that are to be shown by the census of the century in the year 1900.

It is a safe assertion that there is not a station in this country with a present capacity sufficient to satisfy one-twentieth of the demand for light and power that exists within the area of its practical working limits. To reach the consummation of ultimately doing the entire lighting and power service that is to-day being supplied by the use of agents other than electricity, is an undertaking worthy of the united efforts of all who are interested in the electrical industry. The foundation for such a growth must be laid in an unquestioned demonstration that investments in central stations for supplying light and power by the use of electrical currents are safe and profitable, that the service is—in comparison with that rendered by other agents used for similar purposes—a protection to life and property, and that the service can be employed with advantage in economy, health and comfort, by all users that cannot be realized by the use of any other agent.

Those who know best what is required to meet all issues and to establish a business involving the complex factors and conditions assembled in undertakings for central station work, are those who have invested their money in it and are employed daily in its management. To them and their interests, which includes that of all who manufacture apparatus and supplies, as surely as the greater comprehends the lesser, this Association is pledged for well-considered and effective work.

In your deliberations and discussions you have an opportunity to show your thorough knowledge of the subjects in which you are interested. By your actions you can prove yourselves masters of the factors that induce progress and invariably lead to successful issues.

The Twelfth Convention of the National Electric Light Association is now open for the consideration of such subjects and business as may come before it.

The following announcement of the order of business was then read by the Secretary:

For the purpose of securing orderly and prompt action for those attending the Twelfth Convention, the Executive Committee has appointed a Committee on Credentials, the members of which are:

Edwin R. Weeks, Chairman; M. J. Francisco and John A. Seely. The committee recommends the appointment of a Committee on Resolutions to consist of three members. The Executive Committee believes that many questions that can be discussed with great profit to members of this Association do not come to the surface in set papers, nor in the reports of committees. That every such question may be considered a call for "Topics to be Discussed,"

will be made at each session except the last. All topics so proposed will be referred to the Committee on Resolutions, and, if approved, a place will be found for the topic in the order of business.

Mr. Faben, of Toledo, moved that the recommendation read by the Secretary be approved, and that the chair appoint a committee of three on resolutions, which was done, and the motion was carried, the President appointing as such committee Messrs. A. F. Mason, C. H. Wilmerding and C. R. Huntley.

Mr. J. W. Blaisdell, of Chicago, then read the following paper, which had been prepared by Prof. J. P. Barrett, of Chicago, the subject being:

### ELECTRICAL INDUSTRIES AND THE WORLD'S FAIR.

It has been stated by competent authority that had it not been for the exhibition of the speaking telephone at the Centennial Exhibition at Philadelphia the telephone would have been ten years later in receiving popular recognition and becoming a success. It is well known that the individuals who were nearest the telephone invention looked upon it with distrust, considered it a toy and an invention of no great practical importance. But Sir William Thomson, who was in 1876, as he is now, the recognized authority in electrical science, seeing the telephone at the Centennial Exhibition, became enthusiastic over it and endorsed it so warmly that it directed public attention to the invention and made it an immediate success.

Great as are the interests resulting from the telephone which was first publicly exhibited at the Centennial Exhibition at Philadelphia, the importance of this invention extends beyond the particular interests directly concerned. The public attention attracted by the telephone has stimulated activity in electrical industries which warrants the statement that the exhibition of the telephone marked a new era in electrical progress. The telephone and the relation of the Centennial Exhibition to the promotion of its popular success, is mentioned simply as an illustration of the importance of the World's Fair to electrical enterprises. Fourteen years have passed since then, and in three years more the Columbian Exposition in Chicago will be looked for to exhibit the progress which has been made since that date, and to be commensurate with an industry so progressive as to have absorbed an investment of \$500,000,000 in the past ten years. It is not unreasonable to say that there will be more interest in the development of electrical science and in the evolution of the art of electricity as applied to various industries, than in any other one branch of the World's Fair. The rivalry in invention has led the United States to outstrip all other nations in the practical application of electricity. Thus it was that the electrical department of the United States Exhibition at the Paris Exposition saved the United States from complete disgrace; and yet the electrical department of the Paris Exposition was the weakest feature of the entire show. Probably the United States in the Columbian Exposition cannot hope to equal Paris in the matter of its general exposition, but in machinery and in electrical matters particularly we should do a great deal better.

The most striking failure of electricity to play its proper part at the Paris Exposition was exemplified by the Eiffel Tower, which was not only not lighted by electricity, but even had its numberless gas jets lighted by hand, after the old fashioned way. Then the general lighting of the show was not made a feature, but only a very subordinate affair. The only place where electric lighting can be said to have been a feature was in the working of the colored fountains, an English invention and already rather old, but a fine thing and worth repeating at Chicago, with better facilities for spectators. The next most striking lack of the Paris Exposition was in the matter of electric street railways. It would seem that an exposition in these days should have an organized system of electrical locomotion for carrying a lot of passengers quickly and cheaply from side to side and from end to end of the entire grounds. Paris had a steam dummy going around three sides of the ground, but that was insufficient, and the cars were usually crowded just when people wanted to use them. That, however, was on account of the Exposition being such an unexpected and tremendous success. The only means of electrical locomotion used at Paris was an electric crane running from end to end of the machinery building, very slowly, to give people a chance to see the various exhibits from above, and incidentally some rest and some air.

There was also no organized telephone exchange system at Paris. Considering that the Melbourne Exhibition of 1880 had a telephone exchange in full operation inside the grounds, doing substantial service to exhibitors, as well as to the officers of the Exhibition itself, Paris is to be pronounced behindhand in this respect. There was something done in the American section at Paris for the offices of that section and for some exhibitors, but it was not very well done, and was on a very small scale. There may have been other similar telephone exchanges at work, but there was no good general system for everybody and in connection with the city.

It is the intention in the following paper to point out some lines in which the exhibition of that branch of industry, in which we all are interested, should be protected and promoted according to the brief consideration which the writer of this paper has been enabled to give the subject.

In the first place, electricity will find numerous applications in the way of actual service in carrying out the plan of the Exposition. By this I refer to the fire alarm protection signaling apparatus, electric lighting, both arc and incandescent, transmission of power, telephoning and telegraphing. The location of the Main Exposition having been rightfully settled in favor of the Lake Front, which is practically in the heart of the city of Chicago, and within



five squares of the telephone central office, the fire alarm central office, and the Western Union and Postal Telegraph offices, it will be a matter of no serious difficulty to make such connections with the general city electrical service as will give the Exposition the benefit not only of its own special outfit in each of these directions, but also the advantage of its outside connections. Aside from this application of electricity to the utility and necessities of the Exposition, the features in which we are all particularly interested are those which illustrate the progress that has been made in the science and in the art. The success that has attended recent electrical exhibitions, such as the one in Philadelphia in 1884, and the one in the American Institute Fair in New York, give us some idea of what can be accomplished in this direction with the immense multiplied facilities at the World's Fair in Chicago, and with the incentive to manufacturers and inventors which comes from having the attention of the whole world directed to their work.

With reference to telephones, as is generally known, the fundamental patent on the telephone will expire in 1893, and we may expect not only the inventions, accumulated and hoarded by the American Bell Telephone Company for the years that they have had control of the business, to be exhibited at the World's Fair, but also numerous other inventions which will be stimulated by the opening of the field to competition. Thus this feature should be given a much greater consideration, and more attention should be paid to it than in any other previous exhibition. We have seen only the beginning of the growth of the telephone business. This is shown by the fact that in the city of Berlin there are now 13,500 subscribers and the exchange there is growing at the rate of 3,500 per year. I predict that in the city of Chicago inside of ten years there will be 30,000 telephones in use. Such a great increase in the use of telephones calls for apparatus and appliances, the invention of which will tax the best talent of the country for years to come. Of course, in addition to the historical exhibition, and the exhibition of recent inventions in telephones and apparatus applied to telephony, there will be immense numbers of telephones used in and about the buildings of the Exposition.

The matter of telegraphy also should receive its due share of attention. The different forms of quadruplex, the use of dynamos for furnishing the current instead of batteries, and other inventions in which the recent history of the telegraph is prolific, should each and all be suitably presented. Police and fire alarm apparatus of the latest design and best manufacture, together with all appurtenances, will attract a large share of attention.

The telautograph which by 1893 will undoubtedly be a practical success, even if it shall not have ceased to be a novelty, will also come in for purposes of exhibition as well as for extensive practical use.

Motors for driving machinery, furnishing power for various purposes running street cars, etc., will perhaps be even of more practical benefit than any other application of electricity; while electric lighting apparatus of various kinds will take the lead undoubtedly, as it now does, over all the other electrical industries.

It is proposed to connect the two parts of the World's Fair, one situated on the Lake front and the other at Jackson Park, by means of a railroad built out on the lake. The expediency of adopting electricity for motive power on this railroad is at once obvious. Thus the two features of usefulness and exhibition can be readily combined, and in addition to the direct transmission of power, storage batteries could be employed for traction purposes on this road.

It is difficult in enumerating the different departments of electrical enterprises to foresee all of them, and particularly to foretell the relative importance of the different ones three years from the present time. In no field of human activity is invention so active and enterprise so energetic, and when we speak of the different forms of application of this science which are well known at the present day we all know that we are simply on the threshold of future developments which may be confidently expected. At no time in the history of the world has there been so great activity in any given direction as there now is in the department which we represent, and too much cannot be said with reference to the importance of having adequate facilities in the coming World's Fair to display the various industrial and artistic applications of electricity.

What will be exhibited at the World's Fair will undoubtedly be a revelation to the visitors. It should be the aim of the people having the exhibition in charge, so to organize and classify the exhibits as to present clearly and forcibly the progress of the art and the present state of its various departments. A chaotic exhibition of the products of the different manufacturers would accomplish something in the way of creating astonishment and mystifying the beholder. This is not what is desired. It is desired that the World's Fair, as a whole, and the electrical exhibition, as perhaps the most important industrial feature of the exhibition, be made an education. It is not too early now to lay plans for the proper presentation of electrical industries for this great Exhibition of 1893. The combined intelligence of the men who are to-day pushing forward electrical enterprises, working in harmony, will be able to accomplish great results, results which will surprise all of us. But the element of time must enter into all calculations; especially is this the case with a subject so large and so involved as the suitable presentation to the public of the rapidly growing electrical enterprises in their various fields.

The Exposition should be made just what its name implies, a practical exposition of the progress and advances made in the several branches of the science of electricity, and the exhibits should be so arranged that the various improvements may be seen and appreciated at a glance. Thus will the real object of the Exposition be accomplished and a saving of much valuable time to the visitor be effected for it is quite probable that fully 50 per cent. of the visitors to the electrical section will go there with the

earnest desire to become thoroughly familiar by practical observation and study with all that has been done in some certain industry, either to aid in carrying on a certain line of study, or with a view of selecting what they may there conclude is the apparatus best adapted to their needs. In either case time will be an important and valuable factor, and how to enable each visitor to quickly and understandingly grasp the more important details and points of superiority of any exhibit should be the main object of the respective exhibitors.

The usual method followed in the small expositions has been to allot a certain space to each exhibitor and allow him to place therein whatever he may desire to bring to the notice of the visitor. This is a good plan, and one which proves economical in many ways to the exhibitor. Another plan would be to allot space for the various types of apparatus, irrespective of the main display of the exhibitor. That is, to place all telephone apparatus and everything thereto pertaining in close proximity; the same with telegraphic apparatus, arc lighting dynamos, incandescent machines, motors, etc. The carrying out of such a plan will, of course, give two or more separate exhibits to each manufacturer, and thus entail some slight additional expense, both in the matter of suitable furniture, and possibly in the matter of attendance; but all this additional outlay would be more than returned in the excellent results attained, and in the simplifying of the study of any particular type of apparatus, to say nothing of the greater publicity given each exhibit. Of course there would be no objection to an exhibitor's reproducing a complete display of all his wares in the space allotted to him for his headquarters, irrespective of the fact that many articles may also be shown in the respective space to which they belong.

As far as possible a complete specimen of every article and every size should be placed on exhibition. For instance, in the line of motors, there should be one of each size from the smallest to the largest turned out; and so with dynamos batteries etc. In the space allotted to the display of testing instruments the showcases should be placed on a flooring above a foundation made sufficiently solid to prevent oscillation of the needle, or injury to the more delicate parts from vibration or other similar cause. Every article should have a neatly printed card attached, of size uniform in proportion to the character of the object displayed, bearing the name of the article, the manufacturer's address, and a brief description of its intended use, the same appearing in English, French, German and Spanish.

At the present time there are about 430 separate companies or individuals whom we can expect to apply for space, many of whom will have but a single article or two to exhibit. But every one of this number will probably defer action until the last possible moment, unless the importance of securing the necessary space and having his exhibit in readiness within the appointed time is impressed upon him. Some of the manufacturers will have to be coaxed into making exhibits, while others will hesitate on account of the expense entailed. The chief or his secretary must attend to all of this, and must spare no pains to secure not only an exhibit, but the best exhibit possible for each manufacturer to make.

Great assistance in carrying out a comprehensive and systematic plan for the Exposition may be expected from the United States Census, the report of the Electrical Department of which is looked for with great interest.

MR. C. R. FABEN (Toledo): There certainly will be no enterprise presented at the World's Fair that will interest central station men as much as will the electrical department. The amount of detail required to develop a proper exhibition of the appliances presented there and to induce manufacturers to present those features of their business that will be not only of interest to themselves but to central station people as well, and the amount of work involved in the undertaking, demand that action should be taken by this Association now. This being a central station association, the central station people ought to go to work very promptly to lay plans for securing a proper exhibition at that time. For that purpose I would like to present a motion as follows:

"That a committee of five be appointed, of which the President of the Association shall be ex-officio, one, the other four members to be appointed by the Chair, to meet the authorities of the Columbian Exposition and secure suitable facilities for the proper exposition of electrical manufactures and appliances, and in general to work for the interests here represented, and to offer to the authorities of the Exposition the co-operation of the National Electric Light Association to aid in making the Exposition a success."

"That the committee request the selection by the authorities of the Columbian Exposition of Mr. John P. Barrett, of Chicago, to have the practical charge and control of the electrical department of the World's Columbian Exhibition."

MR. PHELPS: I have great pleasure in seconding the resolution which Mr. Faben has offered, and both features of it. That is, the appointment of a committee to secure suitable facilities, and tendering the co-operation of this body with the authorities of the Fair, and also recommending for appointment Mr. John P. Barrett. The paper which has been read to us this morning is about as good evidence as we might need perhaps of the fitness of Mr. Barrett for that work, although doubtless the most of us

knew well enough before. A further reason is that Mr. Barrett has already been commended to the World's Fair Commissioners by the signatures of very many of the most prominent electrical people, electricians, electrical engineers, manufacturers and users of light and power. I think that it would be eminently fit and proper for this Association to take such action at this time as has been proposed. The sooner such action can be had the better it will be for the exhibition. I presume that there is no doubt in the mind of any member of this Association of the entire fitness of Mr. Barrett for the position. I therefore second the motion.

JUDGE ARMSTRONG: I am most heartily in favor of all the resolution except that part of it which recommends the appointment of some particular individual. I think that this Association would make a serious mistake if it did that thing. I have myself recommended the appointment of Professor Barrett, and personally I am heartily in favor of his appointment, and personally am willing to do everything possible to secure that appointment; but it seems to me that the Association would be making a serious mistake if it lent itself to a recommendation of any individual for any appointment. (Applause.) I should be very sorry to see this Association join in recommending anything where there is a possibility of there being, with merit, some competition against it; and I believe that every member of the Association would join with me in deprecating the recommendation of any thing, no matter how good it might be, if, with merit, some competition could be brought against it. We want to be in the position, beyond any question or any cavil, of disinterestedly and impartially standing here as representing all and every thing connected with the industry with which we are associated. We do not want to have the slightest possible suspicion that we are biased in any direction. Therefore, I am very glad to vote for this resolution if we may have that part of it omitted. I may say to the gentlemen who have moved and seconded the resolution that I am willing to join with them, individually, in doing everything possible to have the gentleman who has presented such an interesting paper to us appointed to the position they desire to see him appointed to, but do not let this Association adopt such a resolution. It would be weakening to us, and I think it would be weakening to him. (Applause.)

MR. ALEXANDER: The resolution offered by Mr. Faben, coming immediately after the paper by Professor Barrett was read, puts Professor Barrett himself in rather a delicate position. His paper speaks particularly of the advantages that could be derived by the proper arrangement of electrical exhibits at the Chicago exhibition; and I do not think that he himself would like the resolution to come up now, at least not in that form. If notice had been given by these gentlemen that such a resolution would be brought up in course of the session, it would have given opportunity to gentlemen who are interested in the subject to confer with each other regarding a proper appointment. I therefore move that that resolution be tabled.

MR. DEGENHARDT: I would be untrue to the city of Chicago and to my friend Prof. Barrett if I did not raise my voice in support of his appointment. As I understand it, the resolution has for its object the successful operation of the World's Fair. In the appointment of a neutral man like Prof. Barrett, we have in him all the qualifications set forth in the resolution; and I would like to add that the very support which has been granted to him by signatures throughout the United States is a sufficient guarantee of the feeling which must exist. Of course, we Westerners recognize the fact that you are dying very hard back here, and the World's Fair seems to be the red flag that excites the bull, so to speak. Prof. Barrett is known throughout the United States as an absolutely neutral man. I think that he is free and untrammelled. He has no affiliations that we know of, and is, therefore, a man qualified for the position. I think that this Association owes the city of Chicago as a debt the adoption of this resolution.

MR. DUNCAN: At a former stage of the proceedings of this body this morning, as I understand it, we adopted as the report of the Execu-



tive Committee a resolution to the effect that a committee be appointed by the Chair to whom topics presented for discussion should be referred; and the Chair appointed such a committee. As a substitute for the pending motion I move to refer these resolutions to that committee.

MR. DE CAMP: I think, Mr. President, if we undertake to do that we will never do any business. Resolutions are offered, nine-tenths of which it is perfectly competent for us to discuss in this connection; and if I understand Mr. Duncan rightly, these resolutions are discussed (if that is the proper arrangement) and are afterwards referred to this committee.

MR. DUNCAN: You have appointed a committee to report upon resolutions. It is usual to refer your resolutions to that committee. That committee considers them and reports the resolutions back to the body, making a definite report one way or the other. That then brings up the whole subject matter, and then you can amend or do as you please with the resolution, and we can proceed with the orderly conduct of business. But, if it is the decision of this body to discuss this resolution first, then I am ready now for the discussion. That is all that I am trying to get at. In order to test the sense of this body and to ascertain what our understanding might be in the appointment of the Committee on Resolutions—it was to ascertain the feeling of the body on that that I made that motion. Now if this discussion is to go on, then let us finish the subject matter up now, and we will not need to send it to the Committee on Resolutions. Otherwise it would properly go to the Committee on Resolutions, be reported back, fully discussed and then decided. That is my purpose—not to cut off debate, but simply to come to an understanding.

THE PRESIDENT: I understand you now to move as a substitute to refer the original question to the Committee on Resolutions?

MR. DUNCAN: Yes; the whole subject, as offered by my friend on my left (Mr. Faben).

MR. FABEN: As the mover of that resolution I will say that I offered the resolution as I considered in the interest of the electric light associations. I have not had the pleasure of knowing Mr. Barrett so well as many members here, but the knowledge I have of the man from the say-so of the members, and my judgment of the matter, led me to believe that he was a suitable person for that position. The gentlemen seem to lose themselves a little here in considering this as an appointment. The National Electric Light Association cannot appoint a man to fill that position, but they certainly can pass their judgment on who their choice will be. (Motion carried.)

Mr. Charles A. Brown, of Chicago, Chairman of the Committee on Copper Tariff, then reported as follows:

We had expected that by this time Congress would have passed a tariff bill and that thus there would be some definite result with reference to the duty on copper, in securing which the committee could claim some part. But you all know what the present situation regarding the tariff bill is. The original bill introduced by the Committee on Ways and Means provided for a reduction of 50 per cent. of the duty on various forms of copper. This provision of the bill as introduced into the House was not changed in the House. In the Senate the clause relating to the duty on copper was amended by further reducing the duty to one-half cent per pound on ores and one and one-quarter cents per pound on ingots, bars, plates and pigs, being a reduction of 70 per cent. in one case and 80 per cent. in the other from the present schedule of duties. It is reasonably sure that if the tariff bill becomes a law at the present session of Congress the duty on copper will be reduced at least 50 per cent. Your committee have secured something over 500 signatures to a petition addressed to the Committee on Ways and Means requesting the abolition of the duty on copper. We have mailed something over a thousand circular letters and have made in addition to that a good many personal solicitations. Mr. Phelps, of the committee, personally went to Washington with the signatures to this petition and presented them to the Committee on Ways and Means with a brief but forcible argument in favor of the petition. As no appropriation was made by the Association to meet these expenses the members of the committee themselves advanced the necessary money for postage, traveling expenses, express, etc., to the amount of \$110, in carrying out what seemed to them to be the spirit of the instructions contained in the resolution appointing this committee.

Mr. DeCamp then moved that the report be accepted and the committee continued, and requested the committee, in its next report, to give

some idea of whether the manufacturers will get the benefit of that reduction or whether we will get it.

The motion was carried.  
(Adjourned till 4 p.m.)

The afternoon session of the Convention met at 4 p.m., when President Perry read the following despatch:

DENVER, COLO., Aug. 19, 1890.

To Marsden J. Perry, President.

Denver, Colo., sends greeting to the Twelfth Convention of the National Electric Light Association. May the owl be wise and the spring chicken not devoured. The commutator brush should not be allowed to spark, and may you all see the rising sun without the pendant saw-buck. I regret not being able to be with you. M. D. LAW.

Mr. David Brooks, of Philadelphia, then addressed the Convention on the subject of Liquid Insulation, as follows:

It is rather embarrassing, Mr. President, to come before so large an audience. The five minutes I take will be a brief reference to the advantage of a liquid insulation for underground conductors carrying currents of high voltage. Gentlemen, since electric lighting came into use it has been found that the ordinary tests for insulation do not apply; that is, a test with a galvanometer and a voltaic battery of, say, 1 to 500 cells. That has become apparent, and they have adopted other means in Paris and in London for testing the insulation of conductors that have to carry very high intensity currents. We have seen this noticed in many periodicals. Mr. Wm. Maver, Jr., in an article published in *The Electrical World*, March 1 of the present year, states that a cable measuring 20,000 megohms per mile for insulation in the factory broke down by a dynamo current of 600 volts after being drawn into a conduit. Now, in the ordinary test, if a person should go and measure the insulation of an electric light cable, and he found it was 20,000 megohms per mile, and he took another system of insulation and found that it was only half a megohm per mile, as a general result he would take that which stood 20,000 megohms to the mile. But if you apply to it a current of high voltage from an induction coil or a Holtz machine, you can prove that the one with the 20,000 megohms insulation per mile was broken down by from five to ten thousand volts. Now you take the same No. 4 conductor and insulate it in oil for 20 feet, just as an experiment, and raise the temperature to 200° Fahr. and apply the galvanometer, and it is not half a megohm per mile—just about the one-fortieth part of the one that Mr. Maver speaks of, but when you come to apply the induction coil or the Holtz machine and test it to produce what is sometimes called the break-down or a disruption, it can be broken with 10,000 volts when the other cannot be broken with 500,000 volts. There is the difference between the testing of the insulation of a cable, or an insulator, or a dielectric, if you please, testing it with the ordinary delicate galvanometer, static galvanometer, and testing it for standing a current of high voltage. Now if the current applied to a conductor tests half a megohm per mile, the temperature of the insulation being 212° Fahr., that would not show much; no one on first sight would buy it; but if you are going to purchase a cable and test as they do in England, or give the guaranty as they do now in England, there would be five parts of current going through the insulation to five hundred thousand and five parts going through the conductor; and the small proportion that goes through the insulation is a mere bagatelle, but it stands the current. These are experiments that I have made in Philadelphia, and I would do it here with a Holtz machine, but the atmosphere in the summer and especially on the sea shore is very unfavorable to the use of a Holtz machine.

Mr. Maver, in the article in *The Electrical World*, already referred to, states that a cable measuring 20,000 megohms per mile for insulation in the factory broke down by a dynamo current of 600 volts after being drawn into a conduit.

Twenty feet of that cable would give the proportional insulation of over 5,000,000 megohms, yet it is broken down with the tension of less than a thousand volts.

Now, if we take the same copper conductor and insulate it with cotton or other textile covering to one-eighth of an inch in thickness and immersed in oil, we do not get so high insulation measured with the galvanometer, but it is not punctured or disrupted with a Holtz machine or induction coil by the application of a current of 500,000 volts.

It is easily seen to be very much more difficult to pass a spark through oil than through the air. We twist together two small copper wires, each covered with one thin layer of cotton, the ends of the wires are separated below the twist and the twisted portion immersed in oil, the upper ends each being attached to one of the rods of the Holtz machine. After the discs are set in motion sparks will pass between the two balls until they are separated an inch to an inch and a half, or until the spark passes from wire to wire in the twisted portion. The difference between the knobs as they are gradually separated is the length of spark and corresponding electromotive force required to rupture the insulation between the two wires. If an inch, it is by the authorities 23,400 volts. So long as the current is applied it passes from wire to wire through the insulation after once ruptured, but stopping the current, the insulation is soon restored.

Bearing upon this feature of restoration of insulation, it is the fact that of the 53 conductors laid for the Pennsylvania Railroad company three years since, not one of them has for a moment been interrupted by lightning or any other cause, nor have they cost one cent for maintenance.

The total length of conductors is something over 70 miles.

Taking Chief Walker's report of the total number of miles of overhead wires in Philadelphia, as compared with the number of linemen employed in their maintenance, I find there are two linemen or more for every 70 miles of overhead wires, and, at the rate of \$2.50 per day, there has been a saving of \$4,500 in maintenance as compared with overhead wires during the past three years.

In connection with the fact that oil is so little affected by currents of high voltage, it is well to bear in mind the yearly expense caused by interruption of river cables by atmospheric discharges. Again, a fault in ordinary insulation is developed into a perfect ground by currents of high tension.

Referring to the jar again, if the insulation is punctured, it is restored at once by agitating the liquid. In iron pipes the liquid is continually moving, owing to contraction and expansion of the oil from changes of temperature, and no chance for the current, through a fault or weak spot, to develop into a perfect ground.

This system of liquid insulation is as cheap, first cost, as overhead systems, all things considered.

And how about conduits or subways? I learn from official statements that they charge a thousand dollars per mile per annum for the use of a duct in Chicago and New York, and further, that an electric light conductor carrying a thousand volts costs a thousand dollars per mile or more for maintenance. Two thousand dollars is the interest on \$33,000 and over at six per cent. Can arc lights be furnished under these conditions at a living profit?

I shall not go into the cost, inconvenience and dangers of subways. Those that have used them, and otherwise not interested, can tell all about them.

Last summer I went to Europe and started the business of laying electric light mains. My patents were put in the hands of Johnson & Phillips, London, and they have been very successful, having laid many installations without a single failure or interruption. Their guarantee is that not one-thousandth part of the current per mile is lost.

Underground conductors and underground systems are not popular on account of cost. As before stated, they are as cheap by this system as overhead wires and cost comparatively nothing for maintenance. When electric light companies see their way clear to put their conductors underground I shall be happy to assist them. I will lead the horse to water and hold the bucket for him to drink, and if he doesn't choose to drink he can let it alone.

Mr. P. H. Alexander then read the following highly instructive paper prepared by Prof. Morton, of the Stevens Institute of Technology, on

#### THE DANGERS OF ELECTRICITY.

When the development of electric currents, on a large scale and at a small cost, first became possible by reason of the discoveries of Faraday, Wilde, Gramme, Siemens and others, the question of the dangers to life and property attending their use was brought prominently before the public, just as the dangers attending the use of steam, of rapid locomotion on railroads, and of dynamite were brought to the attention of the world when these powerful agencies first left the experimental laboratory of the chemist or engineer to take their part in the ordinary labor and business of life.

In each instance alike there was a class of people who took the narrow and partial view, that if an agency was dangerous it should be excluded altogether from public use, or, what amounted to the same thing, be surrounded with such exclusions and limitations as would rob it of nearly all its capacity for usefulness, and re strict all possibility of advance and development in its application.

Thus laws were actually passed in England on the first introduction of steam, limiting the pressure in boilers to 30 lbs. on the square inch.

The first railroad charter contained a clause limiting the speed of trains to 12 miles an hour, and when a speed of 30 miles was suggested, it was ridiculed in a prominent journal of the day as an idea simply insane, and it was said that people would just as soon be persuaded to allow themselves to be fired out of a cannon as to be hurled along at such fearful velocities, which would, without doubt, have the most disastrous effects upon the circulation of the blood and other vital actions.

Some of us can also recollect the excitement produced and echoed in the press on the introduction of dynamite, and the stringent laws regarding its transportation, which in many cases only increased the danger to the public by occasioning its surreptitious conveyance in passenger and ordinary baggage cars.

We shall have to be very young indeed not to remember the great popular excitement brought about by the daily press when electric lighting first appeared in the streets of New York, and when flashes of flame were described as proceeding from a horse that had run against an electric wire.

In all the older instances matters have settled themselves in accordance with the laws of human progress and the diffusion of intelligence, and we now have boilers running at pressures of 140 pounds and upwards, trains going more than a mile a minute, and gunpowder largely superseded by dynamite.

What is more, the accidents and injuries actually produced by these several agencies have been vastly less than those caused by the things which they replaced.

A much smaller number of people are killed or injured by high pressure boilers than by low pressure ones. How rarely do we hear of the explosion of locomotive boilers, which usually carry 140 pounds pressure?

The accidents to express trains are as nothing compared to those occurring to freight trains, and the loss of life and injury to passengers by rail is insignificant in its percentage to the number carried, when compared to similar loss and injury incurred in the days of stage coaches.

The same relation has been found between dynamite and gunpowder, the former having largely reduced the proportion of accidents and injuries as compared with the work done.



Two lessons are very plainly taught by the facts of history above alluded to.

First: The world is not going to be frightened away from a new and valuable source of power by the circumstance inseparable from the very nature of all powerful agencies, that it is dangerous if not adequately controlled; but, on the contrary, will develop the new power to an ever increasing, and therefore, more (possibly) dangerous intensity.

Second: Intelligently managed and controlled, the most powerful and, therefore, in a sense, dangerous agencies, become the most efficient protectors and servants of man, and not only aid him in his mission of subduing and utilizing nature, but actually protect him in his work.

Without these "dangerous" agencies man would be reduced to the lowest condition of savagery, where he would be at all times helplessly at the mercy of the "elements" or the blind forces of nature.

With them he not only defies and subdues the beasts which would otherwise be his superiors, but even conquers and renders tributary to his comfort and advancement those vast forces which control the entire matter of the Universe.

Applying these lessons taught by the past history of the world in parallel cases to the problem of the distribution and use of electricity, we see in the first place that the way to deal with its dangers ought not to be the timid, obsolete way of prohibition, or of unintelligent restriction, such as that which proposed the exclusion of locomotives from railroads or the limiting of their speed to 12 miles an hour, but the sensible way of providing adequate safeguards to the new power, and with these allowing it to follow its natural line of development and growth into higher and higher ranges of intensity and consequent efficiency.

It is too well known to all to need statement, that the methods thus pointed out by history and taught by experience have not been by any means universally advocated or followed, and that while many have loudly demanded the exclusion of powerful electric currents, the limitation of their intensity to what they suppose to be necessarily harmless ranges, the users of such electric currents have in too many cases neglected the most obvious precautions.

It is only fair to say in explanation of this latter statement, that this neglect has in many cases been brought about by obstructions thrown in the way of good work by those who were exciting themselves for the total abolition of dangerous currents, and who, like certain "total abstinence" advocates, objected to every mitigation of evil they attacked, because any such improvement weakened their case against it.

As regards dangers to property from fires, the matter fortunately fell at an early period into the hands of the Board of Fire Underwriters, who, in a judicious and business-like way, investigated the subject and formulated such rules as have proved eminently satisfactory, and have proved that under proper regulations as to good work and means of protection, electricity is by far the safest means known to us for the distributing and development of light, so far as "fire risks" are concerned.

In view of the satisfactory results thus obtained, I regard it as a fortunate circumstance that the other part of the problem, namely, that relating to dangers to human life, has been recently taken in hand by a similar organization known as the "Employers' Liability Assurance Corporation."

This association, after collecting a mass of material from a great variety of sources, has some time since formulated a series of rules for the protection of those employed in erecting and operating electric apparatus involving the use of powerful, and, therefore, dangerous currents. These rules have been examined and approved by several of the managers of prominent electric companies, and so far it would appear as if no accidents have resulted from the use of electric currents where these rules have been followed and that most if not all the accidents which have occurred would have been prevented had these rules been followed and obeyed. Having had something to do with the framing of these rules, it is my chief object in presenting the present paper to secure their criticism by those best able to perceive their imperfections, and such suggestions as may lead to their beneficial modification or extension.

I therefore quote them as follows:

First. Do not touch or handle any electric wire or apparatus of any sort while standing on the ground, or while in contact with any iron work, gas or water pipe, or stone or brick work, unless your hands are covered with rubber gloves, and you are provided with such properly insulated tools as have been declared to be safe and in good order by the electrician or other competent officer of this company. If it is at any time necessary to stand on the ground, or on any surface not insulated from the ground, while handling electric wires and apparatus, rubber boots or an insulated stool should be used. In moving wires, hanging on or lying over electric light wires, lamps or fixtures, use a dry hand line.

Second. Never handle any electric wire or apparatus with both hands at once when this can be avoided, and, if it is necessary to do so, be sure that no current is present, or that one or both hands are protected by rubber gloves or other efficient insulation.

Third. When handling line wires, treat each and every wire as if it carried a dangerous current, and under no circumstances allow yourself to make contact between two or more wires at the same time.

Fourth. Never open a circuit which has been in use without giving notice to the superintendent or whoever is in charge of your intention to do so, and at the same time request that the same line be opened at the main station, and kept open until you have given notice that your work on that line is complete.

Fifth. In the dynamo room never go near the belts or dynamos, nor touch any apparatus unless you are fully informed and instructed how to do so.

Tools used by linemen should be provided with insulating

handles of hard rubber or other equally good insulator. It is the duty of each lineman to look after his own tools and see that they are in good order, especially as to their insulation.

Sixth. Lamp trimmers and others engaged in the care of lamps must see that the switch putting the lamp in circuit is turned off before they handle the lamp in any way.

In construction work, a space of at least 20 inches must be left between the holes for pins on the cross arms, so that a lineman may get to the top of the pole and work without danger.

The same insurance association has collected the authentic records of a number of so-called "electric accidents" or accidents happening to the employes of electric companies. I have now before me the abstracts of 91 such cases.

The first thing that presents itself in looking over this set of abstracts is that very few of the accidents are in any way attributable to electricity directly, but would have occurred had the establishment in question been any kind of a factory where power was being used, or any place where heavy objects were being moved. A few examples will illustrate this, thus:

"No. 1. While steadying with a pike-pole a large electric light pole which was being placed in position, a passing 'low-gear' belonging to the Standard Oil Company ran over ankle."

"No. 2. While assisting in hoisting a stick of lumber from the street to the second floor of electric station, was injured in right foot by having the stick fall upon it."

"No. 9. Was going to dynamo, stepped on iron plate temporarily covering a belt hole in floor. The plate tipped and he fell partly through the opening, injuring himself internally."

"No. 17. Was oiling rocker shaft of engine near fly-wheel; leaned back too far and was struck on head by spider of fly-wheel."

The above are fair samples of the rest, and in fact out of the 91 cases but 15 (or about 16½ per cent.) have any direct relation to electricity.

As I have already mentioned, of the 15 cases in which the injury was in any way caused by electricity there are none in which the action would not have been avoided if the above quoted rules had been observed. Thus, beginning with first in order as arranged in the abstracts, all before it having no direct connection with electricity, we have:

"No. 11. While removing the wire from a Brush dial or regulator which had become short-circuited, was slightly burned on two fingers of right hand."

In this case the beneficial effect of rule No. 2 was manifestly expressed, and had the spirit of rule 7 been complied with, even the slight injury experienced would have been avoided.

The next in order is:

"No. 20. Was putting carbon in electric lamp which was out of order and failed to burn. Received charge of electricity, which caused him to fall down from step ladder on to steam-radiator. Two ribs broken."

This would clearly have been avoided by an observance of rule 7.

Time will not permit me to quote all the 15 cases, and I will, therefore, only repeat that they would, all of them, have been avoided by a strict observance in form and spirit of the above quoted seven rules or directions.

Of course, I do not mean to imply by this that these rules are perfect or complete, but only that they seem to be in the right direction, and to furnish a starting point from which further developments may proceed.

No one having even an elementary knowledge of electricity as it existed ten years ago, needed or needs to be convinced of its power to do harm where all safeguards are removed, and the occasional declarations of its harmless character which have been uttered can only be accounted for by reference to that combative disposition which impels some minds always to take a view in opposition to any which may be expressed, and gives birth now and then to a book or pamphlet disproving the law of gravitation or the solar origin of light and heat. To say this is, however, far from agreeing with the other extremists who would banish electricity from our daily walks and occupations, or place it under restrictions which might render it harmless, but which *certainly would* render it relatively useless for the countless purposes in which its efficiency demand its full development.

The true opinion is that which is supported by past experience, and which advocates the fullest developments of power to which this agency can attain, combined with the use of all the means of protection by which human intelligence can protect itself while using to the utmost this potent and, therefore, dangerous weapon in our victorious contest with the inimically destructive forces of nature.

#### DISCUSSION.

MR. FREELEY: In my observations on Professor Morton's paper I should have liked to avoid if possible all reference to the company that I represent, because it might be said that my company, like a great many individuals connected with the business, has its axe to grind. Well, my company has. But my company has another object in view which I think will commend itself to you, and that is to bring about a better condition of things than exists at the present time in connection with the instructions to employes of electric light companies with regard to the dangers which surround them in carrying on their daily operations. When my company started in business here a few years ago they found that in consequence of their being the first to introduce what is known as employers' liability insurance in the United States, that they had really no ex-

perience to guide them upon which they could base rates of premiums for the various electric risks. The company therefore had to refer to experience in England. But there they found themselves somewhat in the same difficulty, as electric lighting was in its infancy, and very little or no attention had been paid to the collection of statistics with regard to accidents to electric light employes. They therefore laid down this basis of charging a rate to the electric light companies: To consider an electric light company in the nature of an ordinary producer of an article, and to add to that a certain percentage for the known or unknown risks which might be incidental to their business. They therefore established what they considered to be a fairly reasonable rate to charge the electric lighting employes in order to protect them in their legal liability for accidents to employes. But, in the course of a short time they found that the rate was inadequate. They found that several serious accidents occurred among their policy holders, and what was of greater importance to them in carrying on their business, they found that the prejudice of the public, which was aroused by the press from time to time, whenever an accident occurred, for instance those which occurred in New York, was so great that when a suit was brought against a company for an accident which had occurred to an electric light employe, and he demanded compensation or damages from his employer for his injuries, it was utterly impossible to carry that case before a jury.

It was considered that electric light companies were carrying on their work regardless of the dangers by which their men were surrounded. As these cases went on accumulating we were compelled as business men to consider what was best to be done. First of all, we had to protect ourselves from loss, and the result was that we were compelled to increase our rates of premium by nearly one hundred per cent. We then set ourselves to try to find out whether we could do anything to bring about a better state of things with regard to the employes of electric light companies, and, if we could do so, whether it was not possible to reduce the rate of premium charged to electric light companies. We accordingly issued a circular to our policy holders asking them to send us for our consideration copies of their regulations for the guidance of employes in carrying on their work. We told them that we contemplated submitting those regulations to an eminent electrical authority that he might formulate a set of simple regulations which might have the effect of minimizing the dangers surrounding electric light men. We received many replies from companies who stated that they had no regulations of the kind at all. Others sent us their regulations, but we found that they did not cover the whole ground. Others sent us on some very good regulations. The result was that we found that there was no general kind of action existing among electric light companies on this subject. We submitted all these regulations, and the matter generally, to Professor Morton. He has drawn up the set of regulations which we have read, and we consider them very good. We also requested him to write a paper for the consideration of this convention.

Now, as Professor Morton says, possibly these regulations are not complete; I therefore ask you to take those regulations into your best consideration, and if you can aid us, either individually or as an association, to complete them, we shall think it a great favor.

MR. FRANCISCO: Suppose that I insure my own company, with a view to protecting it against any claim which can be brought for accidents to workmen. What would be your price, as you stand now?

MR. FREELEY: The premium is based upon the wages or upon the payments. We should charge one and a half per cent.

MR. FRANCISCO: I find from his statement that he charges one and a half per cent. to insure me against any claim that my employes may make. I have been running a station where for five years we have not had an accident of any description. Why should we pay for protecting ourselves against the claims of these men nearly double what other manufacturers would pay for the same privilege! It is a fact that I can insure a quarry company, employing a thousand work-



men, for less than half what you say you would be obliged to charge me for protecting the employes of an electric light company. In the quarry the men are certainly exposed to very great dangers, and several of the quarrymen have been killed during the very time that our station has been running with no accidents at all. I claim that if a station is properly prepared and the lines are properly run, there is no more danger in running an electric light station than there is in any other ordinary business—that is, in any business where you would classify them as an ordinary risk. Why, therefore, should electric light men and electric light stations be called upon to pay additional premiums?

A resolution offered by Mr. Alexander recommending that a copy of the rules prepared by Prof. Morton, as embodied in his paper, be conspicuously posted in every electric light station was adopted.

**E. A. ARMSTRONG:** For over five years we have operated our station, and have had no accident of any kind, with but one single exception. I believe that a door of the boiler room fell down on one of our employes and hurt him somewhat, but you would hardly charge that against the electric light station. The company insuring us told us last week, when our policy expired, that they would require double the amount of premium that we had paid, but so far as I have been able to see, there has been no warrant for that increase in the accidents which actually have occurred; and the report made in this paper fully justifies the conclusion that I reached. A representative of the company says, however, that because of the ignorance and the prejudice concerning this very subject, the companies have been compelled to pay largely in excess of what they ought to pay. Now, it strikes me that on such grounds there can be very little justification in raising the rate as it has been raised upon us; but still the rate is raised. If by the observance of these rules the 16½ per cent, can be further reduced, then it is well; if, however, by a careful examination by the officers of this association, and by a careful report from every company and member of this association, it can be shown that the accidents in electric light stations are less proportionately than in other stations, merely because the men are more careful, dealing, as they do, with dangerous things; merely because the men are more watchful, having, as they do have, greater responsibilities, then we ought to have the full benefit that other companies get in their insurance. I move that the committee on data be requested to examine into and report all accidents happening in electric light stations, and to what they may be attributed. (Carried.)

The committee on National Insurance Rules through its chairman, Mr. George Cutter of Chicago, then made its report as follows:

REPORT OF COMMITTEE ON HARMONIZING INSURANCE AND ELECTRIC LIGHT INTERESTS.

Your committee has at this session simply to report progress, as the object for which it considers itself appointed has not been completed, viz, the codification of a set of rules regarding electric light and power installations which shall become national in character, and be used instead of the many sets of rules put forth by the different insurance associations throughout the country.

We have written the following letter to many insurance associations throughout the United States:

"CHICAGO ILL., April 8, 1890.

"DEAR SIR: At the last meeting of the National Electric Light Association in Kansas City, a committee was appointed to select delegates or representatives from the different insurance associations in the country, and also from the electric light companies to a national electric insurance committee. This committee will probably consist of eleven or thirteen members, the majority to be insurance men. They are to devise a set of insurance rules concerning electric light installations which shall be enforced all over the country. It is found at present that different rules are in force now in different parts of the country, and in many places two sets of rules, more or less conflicting, cover the same territory. We hope to remedy the evils of this by devising one set and have this set supported by insurance men throughout the United States.

"In order to have these rules the best for the purpose, they should represent the average opinion of the various men who have had experience in this particular line, and also who represent the different interests involved. It is our aim to get a committee thoroughly well balanced as to the conflicting interests, so that the resultant opinion of them all will be so strong an expression of the best methods for electric work as to meet the support of all the insurance people and the electric light people also.

"We wish you would name your choice as a representative upon this committee. We are already accumulating

a great deal of information on insurance rules all over the world, so that when this committee hold their meeting they will have the work so far advanced, that a good set of rules can be arranged without very much delay.

"As there are many electric light inspectors who have had valuable experience and understand the subject pretty well, whom we expect to have on this committee; we feel that such a committee will be a great benefit both to insurance and electric light interests. It is our ambition to have this committee so carefully selected that it will become a body of referees to settle all important questions arising in relation to proper electric work. We trust you will realize the importance of this, and give it prompt and careful attention, and be prepared to support the decision of such a committee.

"Hoping to hear from you soon, and to have your support in this valuable work, we remain,

"Very resp'y yours,

GEO. CUTTER,

Chairman Ins. Committee, N. E. L. A."

The answers to these letters were almost universally favorable, and contained many expressions of appreciation on the part of the insurance people of the efforts made by this association to work in harmony with them in devising these rules and in advancing information leading toward good and safe construction.

You can, of course, readily understand that it has occupied much time and correspondence to determine just what associations to approach, and how to approach them, and get them to fully understand our object in order that they should send a representative to act upon this committee. As a result of this work we have the pleasure of informing you that the following gentlemen have come to Cape May as representatives of the various associations and companies named:

COMMITTEE ON NATIONAL INSURANCE RULES.

GEO. CUTTER, Chairman.

COMPANY.	REPRESENTATIVE.
Edison.....	W. Jenks
Thomson-Houston.....	J. R. Lovejoy
Westinghouse.....	P. H. Alexander
Engineering Firms.....	T. Carpenter Smith
Electrical Supplies.....	George Cutter
Philadelphia Bd. of Fire Underwriters.....	Wm. McDevitt
New York Bd. of Fire Underwriters.....	Wm. D. Boughton
Underwriters Ass'n of the Middle Dep't.....	H. O. Eline
National Bd. of Fire Underwriters, N. Y.....	A. A. Anderson
Associated Factory Mutual Ins. Co., Boston.....	Capt. Brophy
Boston Board of Fire Underwriters.....	F. C. Cabot
Western Union Fire Underwriters Ass'n.....	C. E. Bliven
Cleveland and Chicago B'ds.....	John P. Barrett
St. Louis Board.....	Robert H. McMath
Central Station Insurance.....	S. E. Barton
New England Ins. Exchange.....	C. N. Goddard
Southeastern Tariff Ass'n.....	Jno. S. Alfred
Underwriters Association of N. Y. State.....	Babcock

These gentlemen have been in session most of the time for several days discussing the different rules, and laboring to outline a framework, so to speak, or what they term generic rules. It was the general feeling that these rules should be made concise, and as few as possible, and still cover the basic principles of good work.

Your committee have the pleasure of stating to you that the insurance representatives were quite generally agreed with a feeling of good will toward electric light and power installations, and they do not feel afraid of them.

The deliberations upon these set of rules have been referred to a sub-committee for further study, both to eliminate any mistaken positions, and also to frame them in proper wording.

They have also taken the necessary steps to communicate with one another for the purpose of arranging these rules so they can meet the approval of the different representatives and be adopted in place of the rules now in force. It is the opinion of these gentlemen that this work will be accomplished, and that they will enable your committee to report to the next meeting of this association the uniform set of rules that you have wished for, and also that they will be supported by the various insurance associations.

It was voted at the last meeting that we should express to you their appreciation of your efforts to work in harmony with them in this direction and assure you of their good will and reciprocity of feeling in the same line.

Your committee has also corresponded with various European authorities to learn their methods of inspection, and also to secure copies of the rules they have in force, and we have in our possession various sets of rules from England, France, Germany and Italy, and these sets of rules with their accompanying information will probably influence to a considerable extent the rules which we will adopt. The force of this can be especially appreciated by quoting part of the report of the committee on lighting, heating and patents, appointed by the National Board of Fire Underwriters, which report was presented to the National Board last winter:

"The great problem before us to-day, however, is the management of the various systems of electric lighting so as to insure safety from fire. When such lights were first introduced, underwriters congratulated themselves that at last the long sought means of illumination without danger had been found. No matches, no kerosene explosions, no swinging gas brackets would hereafter vex them, but a steady safe and brilliant light, which could do no possible harm, had come among us, and all were happy.

"It did not take many months, however, to discover that the electric light was not the harmless thing we had imagined, but that it was a most prolific source of danger, and its introduction has cost the insurance companies more than any method of lighting heretofore in use. It has come to stay, and some time it will probably be as safe as any light in use, but our knowledge of its properties and of its management must be vastly increased before that time appears. We see the danger, but as yet are too igno-

rant to point out the remedy. What yesterday seemed a safe method of installation, to day proves dangerous, and what we regard as safe to day is likely to develop danger to morrow. We can only wait and study."

For a number of years the National Board has followed the action of the New York Board in the matter of rules of regulating electric light equipments. Those rules were revised and reissued by that Board, January 15, 1890, and it is recommended that they be adopted by this body as thus revised, and promulgated to members.

In this connection, it is proper to say that the National Electric Light Association asks the National Board to nominate a representative upon a committee to be drawn from bodies of underwriters and electrical experts in different parts of the country to devise and recommend rules for electric light installations, which shall be uniform throughout the land, and tend to throw safeguards about the use of such lights. Your committee recommends that the invitation be accepted, and a representative appointed. Certainly, nothing but good can come out of the deliberations of such a committee, and it is necessary that we should in every way increase our knowledge of what has become so important a factor in our business, and if possible, remove some of the dangers now attending it.

Precisely what is expected of this committee in regard to the third topic named in this report, viz "Patents," they are unable to say, but nothing in this department has been brought before them which seems to require any report.

And then to show the opposite opinion held by insurance companies in Europe as well as many in this country: The Phoenix Fire Office Rules of London were issued in 1882, and their edition of 1889 contains the following statements, viz, "Notwithstanding the number of years that these rules have been in force not a single fire has yet occurred from any electric installation that has been placed up in compliance with them. The electric light is the safest of all illuminants, and is preferable to any other when the installation has been thoroughly well put up."

The electric light and power interests are of great importance in Italy and the only rules in force in that country are those established by the government to protect its telegraph and telephone circuits. There are no insurance rules in Italy, and no insurance inspection of electrical installations, and places lighted by electric lights have the benefit of a diminished rate.

In conclusion, gentlemen, your committee respectfully ask for time to complete their work.

DISCUSSION.

**MR. DUNCAN:** There is a statement made in that report to which I desire to call the attention of the chairman of that committee. The committee places itself upon record as making the statement to this association that electric lighting up to the present time is the most dangerous illuminant in this country; and in the latter part of the same report, since 1882, in England, it makes the statement that it is the safest illuminant in the country. Is that correct? Where is the quotation from? That is what I am trying to get at.

**MR. ARMSTRONG:** The National Board of Underwriters.

**MR. DUNCAN:** That is the insurance standpoint. The last statement made is based upon what?

**MR. CUTTER:** That is a quotation from the last edition of the Phoenix Fire Office rules.

**MR. DUNCAN:** In other words, the two statements upon which the committee's report stands are from two standard authorities upon insurance matters, one diametrically opposed to the other. I hope that this committee in its pursuit of facts and in its pursuit of knowledge will so sift the insurance statements, that when it comes before this body again it will be able to say from its own standpoint what are facts and what are not.

**MR. ALEXANDER:** Perhaps the reason why the Phoenix rules show such good results is because on the very first page is printed a very terse sentence, and very much to the point. It says, "In examining your tenders for work for different electrical companies be careful not to accept the lowest tender until you have thoroughly examined all and find that the work will be done just as good at the lowest figure as the highest given." This short sentence or one using similar language, is printed on the first page, and owing to that, perhaps, they had such good results with their rules.

**S. E. BARTON:** There seems to be a little bit of misunderstanding on the part of my friend Mr. Duncan in relation to the quotation in that paper. The report of the National Board of Underwriters which was quoted in the paper is the most asinine conglomerate mass of stuff that I ever read. I have taken the trouble to express myself on the subject. The whole basis for the statement made in that report was founded upon the assumption that the one great fire in Boston last November was due to electrical causes; and Mr. Chairman, there is not a shadow of founda-



tion for that assumption, and I make the statement boldly and challenge any refutation of it. The fire cost the insurance companies something like three and a half or four millions of dollars. In a certain statistical paper it swelled the losses chargeable to electric lighting more than five hundred per cent.; still it was only one fire, only one incident, and that one incident was without foundation of authority. Those are the facts. The number of reported fires which occurred last year from electrical causes was only seventy-three, as compared, I believe, with one hundred and nineteen the previous year for the whole United States. The number of fires was actually twenty-five or forty per cent. less; the amount of loss attributed to fires five hundred per cent. greater. As I have repeatedly made the statement, if that kind of reckoning is fair and is right, why, then you may fairly say that a cow and a lantern are the most prolific source of danger that is known, because they burned up the city of Chicago, with two hundred millions of dollars. The whole subject of the report of the National Board of Fire Underwriters of New York is not worth talking about. I am ashamed of my profession that ever such a report should have emanated from it.

MR. MASON: This seems to be a case where, more than any of which I have had knowledge, the doctors disagree. It does seem to us as if the insurance people had not much confidence in each other's judgment. An insurance man characterizes the report of the largest insurance organization perhaps in America as "asinine," and we are all cheering him; and, if it will be taken in the pleasant way in which I speak it, I rather think it is a fact that insurance men enjoy hugely disagreement with each other. We appointed a committee last year, the committee of which Mr. Cutter, the chairman, has just made a report. We had a more or less definite thought in our minds as to the scope of that committee's work. They have done a work undoubtedly valuable and one that must live and must go on. Yet I have been questioning whether this association does not want to do something itself, and I have thought of presenting a resolution asking the committee to give us a set of rules which it can recommend, and we will consider them here.

MR. ALEXANDER: I want to say that there are several gentlemen here who have come many miles, insurance men, who do not consider that they have a right to the floor, being merely here on complimentary tickets. I think it would be merely fair play to permit these gentlemen to express their ideas. But before you call on them I want to say that I have found these gentlemen, not as Dr. Mason has described them, when I sat with them three long days, but rather inclined, many of them I will say, inclined to do the best they can in our favor. In fact, one inspector said this—and he is an inspector well known, Mr. Goddard of Boston—"If you and Mr. Jenks and Mr. Lovejoy say that my rules are wrong, I will consider that they are wrong unless I can present an argument and convince you that I am right, because you have had experience in the business which I have not had."

After a somewhat prolonged discussion of the subject the whole matter was tabled.

Dr. Louis Bell of New York, opened up a discussion on the subject of the proper classification of the lighting power of incandescent lamps, and the convention adjourned till 10 a. m. Wednesday.

WEDNESDAY SESSION.

Convention was called to order at 10 a. m.

It was in order for the Committee on Patent Legislation to report, but as none of its members were present, upon motion of Mr. Wilmerding, the committee was discharged and the subject dropped.

Mr. C. H. Wilmerding, as chairman of the Committee on Legislation, then made the following

REPORT OF THE NATIONAL COMMITTEE ON LEGISLATION, TWELFTH CONVENTION.

Members of the Committee. Allen R. Foote, Chairman.

- 1. Alabama.....
- 2. Arkansas.....
- 3. California.....George H. Roe.
- 4. Colorado.....C. H. Smith.
- 5. Connecticut.....John C. English.

- 6. Delaware.....
- 7. District of Columbia.....George C. Maynard.
- 8. Florida.....
- 9. Georgia.....H. E. W. Palmer.
- 10. Illinois.....C. H. Wilmerding.
- 11. Indiana.....John Caven.
- 12. Iowa.....
- 13. Kansas.....L. A. Beebe.
- 14. Kentucky.....A. H. Barret.
- 15. Louisiana.....
- 16. Maine.....William R. Wood.
- 17. Maryland.....J. F. Morrison.
- 18. Massachusetts.....F. A. Gilbert.
- 19. Michigan.....J. E. Lockwood.
- 20. Minnesota.....
- 21. Mississippi.....
- 22. Missouri.....Joseph A. Corby.
- 23. Montana.....
- 24. Nebraska.....
- 25. Nevada.....
- 26. New Hampshire.....Alonzo Elliott.
- 27. New Jersey.....Henry W. Pope.
- 28. New York.....E. A. Maher.
- 29. North Carolina.....D. A. Tompkins.
- 30. North Dakota.....Vincent S. Stone.
- 31. Ohio.....Charles R. Faben, Jr.
- 32. Oregon.....P. F. Morey.
- 33. Pennsylvania.....A. J. DeCamp.
- 34. Rhode Island.....Marsden J. Perry.
- 35. South Carolina.....George B. Edwards.
- 36. South Dakota.....
- 37. Tennessee.....
- 38. Texas.....
- 39. Vermont.....M. J. Francisco.
- 40. Virginia.....
- 41. West Virginia.....John B. Carden.
- 42. Wisconsin.....S. S. Badger.
- 43. Washington.....

At the Eleventh Convention this committee was instructed to "report for the action of the next convention, such changes in the Constitution as will in its opinion best provide for the membership and representation of State Associations in the National Association." (Volume VIII., page 249.)

After this action had been taken, the convention raised a special committee charged with the duty of making a general revision of the Constitution of this Association. In view of this, this committee has considered itself discharged from further consideration of the subject.

By action of the Eleventh Convention, this committee was instructed "to co-operate with the New York State Association in securing such an amendment to the Execution Law of that State as to require a special apparatus to be devised for the purpose, that shall generate a current of not less than 10,000 volts."

No request has been received from the New York State Association for such co-operation, and so far as this committee is informed, no effort was made during the last session of the Legislature of that State to so amend the law. In the light of the reports made regarding the experimental execution that has since taken place in that State, it is now probably as clear to the public as it has been to this committee, that if executions are to be made by the use of electric currents, the amendment to the execution law recommended by this Association at its Eleventh Convention is demanded by every humane and equitable consideration.

To give practical effect to the "Memorial and Statement," presented to Congress in the name of this Association by its president, which was presented in the United States Senate by Senator Hale, on August 5th, and was referred to the Committee on the Census, and ordered printed:—A member of this Committee has prepared a bill which was introduced in the Senate of the United States, August 15th, by Senator Hale. It was read twice and referred to the Committee on the Census.

Your Committee recommend that the Association endorse this bill and urge its enactment, and that a resolution of thanks be tendered Senator Hale for his courteous and prompt actions regarding this subject.

The bill is as follows:—

51st Congress.  
1st Session. S. 4,329.  
In the Senate of the United States.  
August 15, 1890.

Mr. Hale (by request) introduced the following bill, which was read twice and referred to the Committee on Census.

A BILL

To amend an act entitled "An act to provide for taking the eleventh and subsequent censuses" approved March 1st, eighteen hundred and eighty-nine.

Be it enacted by the Senate and House of Representatives of the United States of America, in Congress assembled, That, for the purpose of rendering the investigation of the electrical industries by the eleventh census thorough and complete in every detail, the Superintendent of Census, under the direction of the Secretary of the Interior, is hereby authorized and directed to make such subdivisions of the subjects as may seem to him advisable, and to associate with the special agent now commissioned to investigate the manufacture of electrical apparatus and supplies and their uses, as special expert, the ablest person whose services can be secured to write the statement for each subdivision so made, subject to the supervision of said special agent; and the sum of fifty thousand dollars, or so much thereof as may be necessary, is hereby appropriated, out of any money in the Treasury not otherwise appropriated.

During the legislative season of 1889-90, comparatively few State Legislatures were in session. During the coming legislative season, 1890-91, a large number of State Legislatures will be in session.

If legislation touching electrical interests proves as attractive to the coming legislatures as it was to those that

have recently been in session, there will exist an exciting cause sufficiently urgent to fuse all central station companies in every state into a compact organization for the protection of their mutual interests.

That ill-advised legislation will be met with in every state admits of no doubt. So long as would-be law-creators think it a factor of popularity to show in their legislative records that they introduced bills or advocated measures that are intended to be, or are in fact antagonistic to the practical development of the electrical industries, such things will be done; or, so long as persons interested in patented apparatus and systems think they can gain a commercial advantage for such interests through legislative enactments; they will seek to secure such enactments regardless of their effect on electrical interests in general.

That those interested in the electrical industries in each State will be thoroughly organized and equipped to meet the emergencies that will be thrust upon them is very much in doubt. There is no sense of security equal to ignorance of danger. For those who are ignorant of a danger it has no existence. This, we fear, is the condition of most central station companies in this country regarding impending dangers from legislation. In view of this, the greatest service that may now be performed is to state the threatening dangers that they can no longer remain in ignorance of them. To do this there is no need to speak of unreal things that are but creations of the imagination. Sufficient material for the purpose is found in the record of things that are.

To show the tendency and animus of thought of those intrusted with the responsibility of legislating for the good of the people, a critical analysis is asked for the following brief reports on the work done by the legislatures of a number of States during the last season:

CONNECTICUT.

(Senate Bill No. 4. Chapter IX.)

An Act relating to Attachments and Judgment Liens.

MASSACHUSETTS.

No better presentation can be made of the subject for the State of Massachusetts than to present in full the Report of the Counsel of Massachusetts Electric Lighting Association, made at its first annual meeting under date of July 8, 1890.

(Report was appended.)

NEW JERSEY.

February 12, 1890, a substitute for "Assembly 113" was introduced "by Committee on Municipal Corporations." "An act relating to electric telephone and telegraph wires and creating boards of electrical control in cities of the first and second class."

February 14, 1890, Assembly No. 6. Introduced by Mr. Smith and referred to Committee on Corporations: "An act in relation to telegraph, telephonic and electric companies in the cities of this State."

Copies of these bills were in appendix.

NEW YORK.

January 21, 1890. In Assembly No. 160. Introduced by Mr. Whipple, read once and referred to the Committee on Ways and Means:

"An Act to create a board of electrical commissioners and to define and regulate its powers and duties."

February 20, 1890. In Assembly No. 598. Introduced by Mr. J. H. Stevens (by request), read once and referred to the Committee on Electricity, Gas and Water supply:

"An Act authorizing water companies to manufacture and use electricity for the lighting of streets, public places and private buildings in cities, villages and towns within this State."

February 21, 1890. In Assembly No. 629. Introduced by Mr. Whipple, read once and referred to the Committee on Electricity, Gas and Water supply:

"An Act to protect life and prevent accidents in the use of high tension electric currents."

April 4, 1890. In Assembly No. 1887. Introduced by Mr. Molan, read once and referred to the Committee on Electricity, Gas and Water supply:

"An Act to create a State board of commissioners of electrical control and to define and regulate its powers and duties"

April 18, 1890. In Senate No. 618. Introduced by Mr. Erwin, read twice and by unanimous consent ordered printed, and when printed committed to the Committee on General Laws:

"An Act to create a board of electrical commissioners and to define and regulate its powers and duties."

April 18, 1890. In Senate No. 634. Introduced by Mr. Erwin, read twice and by unanimous consent ordered printed, and when printed to be committed to the Committee on General Laws; report favorably from said Committee, with amendments, and committed to the Committee of the Whole:

"An Act to create a State board of electrical control and to define and regulate its power: and duties."

In transmitting copies of these bills to the Chairman of this Committee, J. W. Eaton, Jr., attorney, of Albany, N. Y., writes as follows:

"None of these bills have become laws. I am of the opinion that an attempt will be made next year to rush through the legislature a bill combining most of the principal features of those sent you unless some determined opposition develops in the meantime. I believe there is also a movement in favor of adding an electrical expert to the present railroad commission and putting the matter under their charge. There was no law of general interest affecting electrical lighting passed this season."

OHIO.

The legislature of this State was urged to action by the following highly electrified paragraph in the inaugural address of Governor Campbell: (See reports in daily press, January 13, 1890.)



"The application of electricity is rapidly opening up new fields of legislation. Unless something be done to prevent the sacrifice of life daily resulting from the effect of electrical wires, the companies which put up and control them will have grown so rich and powerful that the passage and enforcement of proper laws will be difficult. Municipalities have attempted to enforce regulations for protection from such dangers, but without satisfactory results. The duty of investigating the generation and distribution of electrical currents is one which presses upon you. The investigation should be prompt and thorough; the result thereof made public; and such action taken as may, in your judgment, throttle this evil in its infancy."

The following bills were introduced into the Ohio legislature at the last session:

"A Bill concerning electric wires and circuits dangerous to life and property."

"A Bill to authorize the construction of subways and underground conduits in which to place electric wire cables and other electrical conductors in cities, towns, and villages of this State."

"A Bill to regulate electric light companies so as to protect the public from accident and damage from the same."

"A Bill relating to electrical conductors for electric lighting in cities of the first grade of the first class, and the removal of overhead wires."

#### VIRGINIA.

Senate Bill No. 238. A Bill for the prevention of danger from electric currents. Patron—Mr. Lovenstein. Referred to the Committee on General Laws.

While this report does not completely cover the ground, owing to difficulty experienced by this Committee in obtaining copies of bills and definite information regarding action taken on them, the showing is sufficient to demand attention from every one interested in the electrical industries, and will enable them to form some idea of the legislative work that is near at hand during the season of 1890-1891, when the legislatures of some thirty-seven States will be in session.

This Committee desires to call attention to the fact that all legislation is directed to the regulation of the use of electrical apparatus, not to its manufacture and sale. This use includes all forms of apparatus, the telegraph and telephone, as well as the generation and transmission of electric currents for light and power. Such legislation affects primarily the interests of those who have their capital invested in plants for furnishing such service and thus establishes a community of interest between them. The interests of manufacturing companies and supply houses in such legislation is secondary, as they are only affected through the effect on operating companies. For these reasons, and in view of the fact that legislation is confined to State legislatures, there is a real necessity for the operating companies in every State to form themselves into associations for the development and protection of their mutual interests.

In analyzing the subjects of legislation, this Committee would be untrue to the interests it represents should it fail to bring to notice the fact that most of the so called antagonistic legislation is not the result of a popular demand, but issues from those interests that seek a commercial advantage by legislation that, either directly or by implication, would create conditions favorable to their particular apparatus or systems. A diminution of efforts of this kind may be reasonably expected, as the art of generating, distributing and using electric currents becomes more and more a matter of common information and electrical systems approach more nearly to the zenith of their development.

THE PRESIDENT—The Committee on Legislation have in their possession, and it will be transferred to the secretary to be incorporated in the volume of proceedings of the convention, all of the bills, in full, referred to in that paper, and of course they will be at the service of the central station men: and I have no doubt they will prove very valuable indeed as showing the general trend of the legislatures throughout the country.

I learned with much pleasure this morning of the presence here among us of the first man who ever occupied the chair of the National Electric Light Association; and I think we shall all be very glad indeed to hear a few remarks from him.

MR. BOWEN—Mr. President and Gentlemen of the Electric Light Association: You certainly have placed me under great obligation by the graceful compliment which you have conferred upon me in asking me to stand before you and look at the child that was born some six years ago. It is true, as the chairman has stated, that I called a convention to order in Chicago, and I did it after some weeks of labor in sending out circulars, etc., inviting the men who were engaged in the electric lighting business to get together, to become acquainted, to rub together slightly and see what the effect might be. My own opinion was that it would be useful to us all, and to that end we created a little committee in Chicago, and I was made the chairman of it, and I had the honor of sending out those circulars, and in responding to the circulars there were about one hundred and fifty gentlemen who came from all quarters of the Union to Chicago. I mention, as I stand before you, an incident which occurred, which often has come to my mind, and it was this: Mr. Morrison, of Baltimore, said to me, on being acquainted, "What are your plans?" I said, "Well, we have no underground plans or overhead plans. My plan has been simply this, to invite the electric light men to come together, to become acquainted with each other, and after I have called the convention to order and you are all in the room which has been provided for

you, my duty is done. I have no plan at all, because I have the utmost confidence in the capacity of the men that have taken hold of this great business, the lighting of the world, to take care of themselves, and so I have made no plan whatever." (Applause.) And so you see, gentlemen, that it gives me the greatest pleasure in seeing the growth and the activity and the real benefits that have come to the country from this organization of the electric light fraternity. I cannot go anywhere scarcely, it may be the most remote town—and I have been all over this country and a good deal over Europe during the last year, and I say to you that America to my mind seems to be ahead of Europe in electric lighting business; and so what shall we finally come to? I do not make any prediction, but I say to you, gentlemen, you have only opened the first page. I expect to live to see the day when all these little towns all over the country shall be illumined with electric light, and we shall have not to grope about in darkness as much as we have heretofore; because some of you gentlemen are going to develop plans by which all the world may have the light at an expense so nominal that they cannot afford to be in darkness; and so the world will be indebted to the electric light men for all of that.

On motion of Mr. Weeks, Mr. Bowen was elected to honorary membership in the Association.

THE PRESIDENT—We will now resume the regular order of business and proceed to the consideration of the report of the National Committee on Legislation.

MR. MASON—Mr. President, I notice that this report now under consideration, and recently read by Mr. Wilmerding, refers to a bill that is now in the Committee on Census, the Committee of the Senate. I beg to offer the following preamble and resolutions:

WHEREAS, On the 15th of August, 1890, the honorable Senator Eugene Hale, introduced in the Senate of the United States a bill to amend an act entitled an Act to provide for the Taking of the Eleventh and Subsequent Censuses, approved March 1, 1889, and

WHEREAS, The said bill was read twice and referred to the Committee on the Census, and

WHEREAS, In the opinion of the National Electric Light Association the passage of this bill is essential to render the investigation of the electrical industries by the Eleventh Census thorough and complete; therefore,

Resolved, That the President of this Association be requested to express this, our opinion, to the Committee on the Census and urge the Committee to favorably report to the Senate the bill referred to.

Resolved, That the thanks of this Association be tendered to Senator Hale for his services in the matter of the bill above referred to.

On motion Mr. Mason's preamble and resolutions were adopted.

Mr. M. J. Francisco, of Rutland, Vt., then read a very carefully prepared paper on "Municipal Lighting," which elicited considerable discussion. The reports of the Committee on Resolutions was then submitted, as follows:

DR. MASON: (Chairman.) To your Committee on Resolutions have been referred only two. I will read the first:

"That a committee of five be appointed, of which number the President of the Association shall be ex officio one, the other four members to be appointed by the President, who shall offer their services to the authorities of the Columbian Exposition with a view to securing suitable facilities for the proper exhibition of electrical manufactures and appliances, and in general to work for the advancement of electrical interests, and to offer the authorities of the Columbian Exposition the co-operation of the National Electric Light Association to aid in making the Exposition a success."

DR. MASON: The second resolution which came to our hands is the following:

"That the committee request the selection by the authorities of the Columbian Exposition of Mr. John P. Barrett to have practical charge and control of the electrical department of the World's Columbian Exposition."

Your committee recognizing the fact that while before the present gathering probably the larger part of the members of this Association had personally recommended the appointment of Mr. John P. Barrett by the authorities of the Columbian Exposition to the charge of the electrical department of the World's Columbian Exposition, yet that, on the floor of the Convention members have expressed the opinion that it is outside the province of this Association to offer such recommendation; your committee, therefore, return this resolution to the Association, suggesting that it act upon the same without suggestion from its committee.

Upon motion of Mr. Brown the report of the committee as to the first resolution was adopted.

THE PRESIDENT: The second is a resolution that the committee request the selection by the authorities of the Columbian Exposition of Mr. John P. Barrett to have practical charge and con-

trol of the electrical department of the World's Columbian Exposition. The committee returned it without recommendation.

MR. ALEXANDER moved that the resolution be laid on the table which, after a roll call vote, was done.

Recess till 4 p. m.

#### AFTERNOON SESSION.

The convention was called to order at 4:30 p. m.; when Mr. A. J. DeCamp, of Philadelphia, read a paper on the Value of Details in the care and labor of electric light stations, as follows:

MR. DeCAMP: It certainly is a fact, apparent to any one who has had the handling of electric light stations, that it is essentially a business of detail. The larger items about the business are very easily handled. They will take care of themselves if they are put in the right direction, but there is an indefinite number of small things which very materially affect the successful operation of an electric light station. As an illustration of what I mean by that term, I will say, that after considerable reflection and dividing the items worthy of care and attention in the management of the business under fifty heads, all of which have to be kept track of, all of which are a positive and a direct item of expense or income, I find in looking over it for this purpose, one, two, three, four and five items which I have had to class as miscellaneous expenses, by which I mean are grouped all those items of expenses which have a bearing on the business in general not chargeable to any one of the particular heads under which I have seen fit to group the business. Now in going further, in looking at the records, I find that the amount involved in miscellaneous items for the last year in one company was about \$15,000; going further, in looking into the records to see what they consist of, the space occupied on the book of the company to cover these small items was very nearly twice as much, in other words it covered twice as many pages as the whole of the other part of the business. The items there reached from one penny up. There is no doubt but that detail may be carried to such an extent that it becomes burdensome. It may become unprofitable on some particular item, but we can only treat this matter as a whole. Now the effect of that, other than the actual amount of money, is that by the insistence upon detail and consequently a check upon waste, inasmuch as those details develop on the part of employes of the company and those who have the use of your property—you either use it for good or for ill—that there is a supervision over that and consequently a greater care on their part. I will have to illustrate somewhat, and I will say that in one item of carbons alone, where they were treated, you might say, by the inch, the reduction in the expense of the carbon caused after a system was adopted by which they were accounted for on the basis of the inches, was a saving of nearly fifty per cent. in that item alone, and on following the adoption of that plan. That is proved to be correct because it has been in practice for the last five years fully. Another important thing is the matter of discipline, because it is utterly impossible to get the detail part of your business thoroughly carried out unless you have a thorough discipline about your station. The most important item in the whole operation of an electric light station in point of dollars and cents is that of labor, and I do not see but what it will always be the case. It is a most unsatisfactory thing to deal with. I remember there was a time when we thought that 60 lamps on an ordinary circuit was a day's work for a man. Now they trim a hundred lamps more easily than they used to trim 60 and my own judgment is that in the course of time we will work up so that 150 will be no harder than 100. But it takes patience and great care to bring that about without a temporary effect upon your business and the perfection of your service. A custom of dealing with labor, I think, which requires the counting of every minute of time for which a man is employed has a very beneficial effect. I think that alone can be credited with a reduction in the pay roll in the course of three months, in which it is getting into shape, of some 25 per cent. Now it takes a little time to do that and you can count that time lost, and when you get ten, or fifteen, or twenty men they are scattered all over a great city in groups of two, or three, or a single man. He gets outside of your control and you have no means of checking him. He may do a half day's work in a day, if the account is settled at the end of the week or at pay-day. A custom adopted for the men of having a slip furnished to them on which they account for every hour of their service, gives the man who has charge of them an opportunity of judgment for himself whether they have employed their time properly during that ten hours. The adoption and the rigid enforcement of the thing in our station did not grow out of any idea of accomplishing the object which it has accomplished. In the early history of the business it was the custom of my company to do a great deal of work without charge. That was done for policy sake. The question arose as to the enormous expense of our labor and the number of employes we had on our pay roll, what they did and how they could employ their time. The balance was on the wrong side of the sheet and it received very careful attention. The number of men apparently required for the operation of the station was very far in excess of what anybody ever supposed it would be. In looking into it we found that there were two or three men working here, and two or three there and three or four somewhere else. What were they doing? Well, they were making changes; they were shifting the position of lamps; they were doing this, that and the other thing. Well we were going to be through with that—that would all be done with, and we could let these men go, we thought. But the fact is they never did go.

That work was all being done without any charge, and the shortest way of getting it was to say, "Here now,



that is all right, we must attend to the demands of our customers. If they have anything that they want done, it must be done and there is nobody who is better qualified to do it than we are. We do not want to leave it to somebody else to do." So we closed that month and started in the next on the basis of charging for that work. The basis of that charge was mainly for the labor. The labor was charged at thirty cents an hour and all waste materials. We did not charge for anything that would be incorporated into our own property, but we did charge for wires and screws and things of that kind that would probably never be of any use, except for that particular purpose. At that time, I think we were running about 350 lights, and when, at the end of the month, we charged that up and footed it up to see what it amounted to, it amounted to eight hundred and some odd dollars. We tried to collect it, but I presume we did not collect more than \$200. People demurred and would not pay it. But it brought the thing to an understanding. Now, no work is done after the first installation, unless it is to be paid for by our customer, and we get an order from our customers, in which they order the work to be done and to be charged to their account. That brought the next month's charges down and all we had occasion to charge them, was something less than \$200. There could be no better proof in the world than that very fact that, as long as people did not have to pay for a thing they were very free to indulge their fancies.

Another point. We sent a man out to do a job and he comes in and charges three, four, five, six, ten hours' time. The man for whom that work is done cannot account for more than an hour or two. Then comes your dismission on the payment of that account, and it is a great trouble. We know nothing. We charge a man time from the time he leaves the station, till he gets back and reports to us, and whether he has put in that amount of time, less the time of coming and going, of course, we have no means of knowing, at least we did not; we get nearer to it now. A man goes on duty at seven o'clock and is employed for ten hours. He has got to account for these ten hours through the day, where he has been. Now your superintendent can follow and he can come to some conclusion. If the man says I was there two hours, and, in the superintendent's judgment, it is a one hour's job, you put a check on that man; but under the old system he could not tell where that man went to, he might have been on two or three jobs.

The electric lighting business is not in such condition that you can take the ordinary stand and say to the public, "You will take just what we can give you, and just as we want to give it to you, or nothing." We make our contracts as specific as we can; but we have not got a contract under which we have not given more service than we agreed to give. The service rendered is never below the standard. We have lights running on the twelve o'clock service plan; and our contract for that service cover seven hours of maximum burning. That would mean strictly that at no time was the service rendered by those lights to exceed seven hours, which, in the winter months, is from five to twelve. But that does not do, because five o'clock is not early enough during three or four months of the year, when the lamps are sometimes lighted as early as three o'clock. It means more than seven hours in point of fact. It means rather an average of seven hours than it does a maximum of seven hours. In any city the restrictions on the running of wires may make it necessary that you put half-night lights on all-night circuits with the object and purpose of switching them off, individually perhaps, at twelve o'clock. A customer can hardly be relied upon to do that. He may do it, or he may not do it. The only safe way to do it, is to have them switched off by your own employees. It is the same way with all-night lights, which might be run, and sometimes are run, for fifteen, sixteen and seventeen hours, starting a portion of the lights at three or four o'clock. You must give the people what they want, or you will finally lose your business. Now, those are small things, but I have held to the opinion that, to go into all of those details of the means of which you rent your lights, and employ people to switch them off, or any other means, that can be devised to do it, is an item of expense that does not pay. That is, it does not pay for what you get in return.

I do not think that there is a very general or a high appreciation put upon the methods of arriving at just what your product cost you. I think that this is recognized in the incandescent work, but not in the arc work. As long as I have been connected with this association, and as large an acquaintance as I have among electric light central station men, I never have found any one yet who seemed to have any appreciation, or any interest in knowing just exactly what his product cost him on the same basis on which he sold it. To get at the cost of a light, or of any particular part of it, it is very generally figured up as a horse power. But the point that I have always contended for, is this: I rent a light for a given length of time, for a year, if you choose, which is the most favorable contract that I consider that we can make, because it gives us the longest service; and in doing that, if you figure it on the basis of exempting Sundays, you rent your lamps to furnish 312 lights, which you sell at so much per light. Now, you really want to know not what the 312 lights cost you, and how much you get for them, and take the difference, and let that be profit or loss, just as happens to be, but you want to know just what each one of those lights costs you, and you want to know it as a whole; you do not want to know whether it takes one horse power, or two horse power, or a half a horse power; as there are a great many other things besides horse power that enters into this question.

Another thing that I find is a very common practice is to have a uniform price for a light of a certain character, whether the contract is for furnishing light for six months or for a year. The same rate for the longer and the shorter term is unjust to your long contract customers. It is a very easy thing to rent lights during six months of the year, commencing the 1st of September, October or November, and it is a very easy thing to keep such customers because they want the lights most at that time. But in the sum-

mer time people discontinue the use along about the first of March, April, May or June, and so you have an idle lamp during the summer, in which you have your money invested, waiting until the fall season comes around again in all probability. I contend that the user of that lamp has no right to expect to get that light at the same price per diem as the man who pays you for a service of 312 nights in the year. But that is almost universally done. I contend that if we could run our arc light machines from the time of starting up in the morning, continuously, as we run the incandescent machines, and make contracts to run from time to time at certain hours of the day and charge by the hour, or at least by a group of hours, we would meet a very great demand and do justice to customers and popularize the business.

Mr. DeCamp's paper was listened to with deep interest, and was the subject of considerable discussion, which was participated in by Messrs.

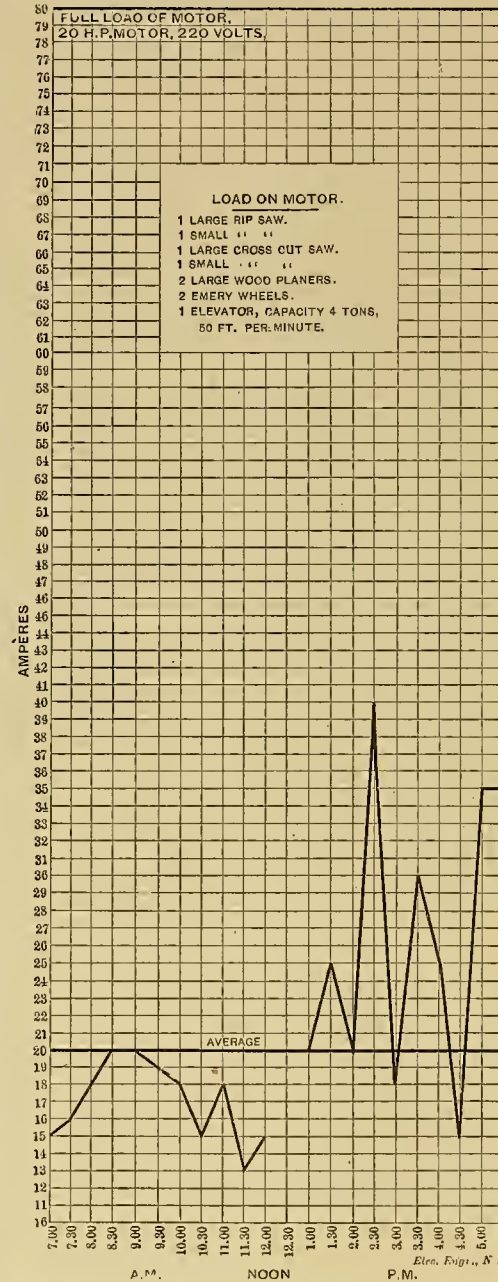

Average Load.....25 per cent. of Rated Capacity.  
 Maximum Load.....50 per cent. of Rated Capacity.  
 Average Load.....50 per cent. of Maximum Load.  
 Shafting.....75 per cent. of Average Load.

No. 1.

A PROPER BASIS FOR DETERMINING ELECTRIC MOTOR RATES—LOAD DIAGRAMS.

Price, Hart, Renshaw, Wilmerding, Weeks and others.

Mr. H. L. Lufkin's paper on

"A PROPER BASIS FOR DETERMINING ELECTRIC MOTOR RATES"

was read by Mr. Joseph Wetzler of the "Electrical Engineer," as follows:

The equitable adjustment of motor rates, or rather the rates per month, or year, for the supply of current for the operation of electric motors, has long been a matter of considerable annoyance to companies supplying electric power. It is obvious that to invariably charge the motor user an arbitrary rate per horse power for the motor which he uses, based on its rated capacity, and regardless of the work it is doing, is not satisfactory, for the reason that a manufacturer usually prefers to buy a motor somewhat more powerful than his work really requires, and thus avoid the possible damage to his motor from overload, or the strain to which any piece of machinery is subjected when constantly operated above its normal working capac-

ity. Again the manufacturer may contemplate an increase in his plant in the near future, and, in buying a motor, will provide one of sufficient capacity to operate his prospective increase.

To illustrate graphically the practical operations of motors under load, I have taken a large number of records of motors in actual service, and from these records have laid out ampere curves or daily load diagrams, which will illustrate very clearly the fluctuations in the current supplied to motors in actual practice. Other interesting fea-

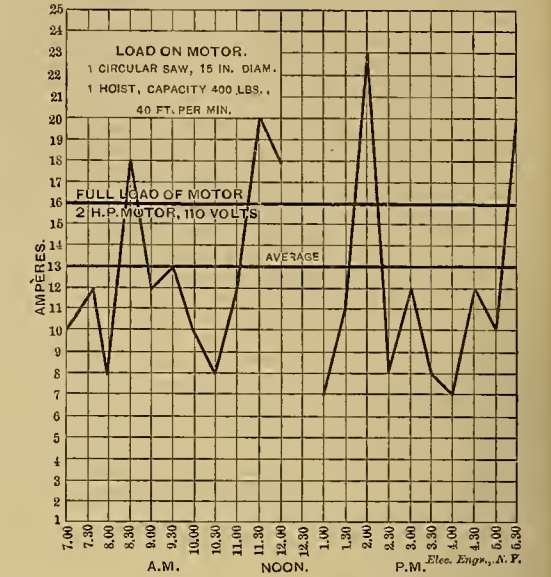

Average Load.....81 per cent. of Rated Capacity.  
 Maximum Load.....44 per cent. in excess of Rated Capacity.  
 Average Load.....51 per cent. of Maximum Load.  
 Shafting.....55 per cent. of Average Load.

No. 2.

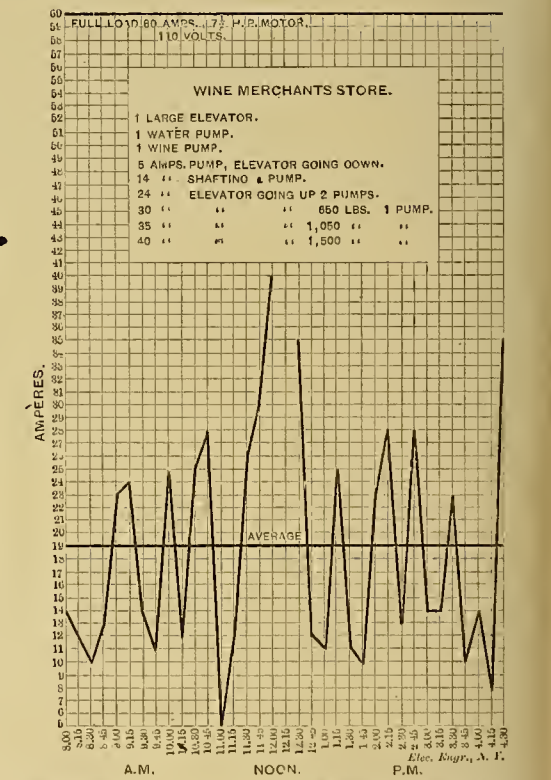

Average Load.....32 per cent. of Rated Capacity.  
 Maximum Load.....67 per cent. of Rated Capacity.  
 Average Load.....47 per cent. of Maximum Load.

No. 3.

A PROPER BASIS FOR DETERMINING ELECTRIC MOTOR RATES—LOAD DIAGRAMS.

tures of these curves are the maximum, minimum and average readings as related to each other; the current consumed in driving the shafting as related to the average current consumed; and the peculiarity of the records of motors operating elevators.

Copies of these load records are illustrated in the accompanying diagrams. The vertical lines of these charts, you will notice, represent hours of the day, and the horizontal lines, amperes. In making these records an ammeter was placed in the circuit in series with the motor and each reading taken was dotted on the chart where the ampere line, corresponding with the reading taken, intersected the hour line corresponding with the time at which the reading was taken. By connecting these dots together with a continuous line we, of course, obtain the diagrams or curves shown.

The highest average use shown in any of these records is in diagram No. 2, with an average use of 81 per cent. of the capacity of the motor; this record also shows an overload of 44 per cent. at the 2 P.M. reading. Diagram No. 8 shows the lowest average, it being in this case but 24 per cent. of the capacity of the motor. A composite average of all these records shows that the average use of an electric motor is but 43.57 per cent. of its rated capacity.



It is a fact that many central stations which still use a "maximum or motor capacity system" of charges have adopted a schedule with the fact in view that where the motor is used for the usual run of intermittent work its average use is much below its capacity. The circumstances of motor use are, however, so varied that a system of rates or charges for power which shall better adapt itself to this wide range of conditions has already been adapted by many central stations, especially those operating constant potential power circuits. This system of charges I will call the "maximum reading system," which is based

the average power delivered to this user is but 67 per cent. of the maximum reading, the station actually receives at this nominal rate of \$6 per horse power, an actual rate of \$9 per month per horse power for the power actually delivered.

The central station supplying this particular motor has adopted the "maximum reading system," and this rate of \$6 per month per horse power is their standard charge for motors showing a reading of 5 h. p. and over, up to 15 h. p. From 15 h. p. up their charge is \$5 per month per horse power. Their monthly bills are also subject to a discount of 5 per cent., I believe, if paid promptly on the first of each month.

To return again to the diagrams. The records, twenty nine in number [Lack of space compels us to omit the publication of many of these cuts.—EDITOR.] are of so varied a character that an average taken from all the records will, I think, show within 1 per cent. or 2 per cent. of the general average conditions found in electric motor practice. The conditions as shown by these records, are as follows:

Average load on motor, 43.57 per cent. of its capacity.  
Maximum load on motor, 68.24 per cent. of its capacity.  
Average load on motor, 64 per cent. of maximum load.  
Reducing these averages to dollars and cents we have the following results:

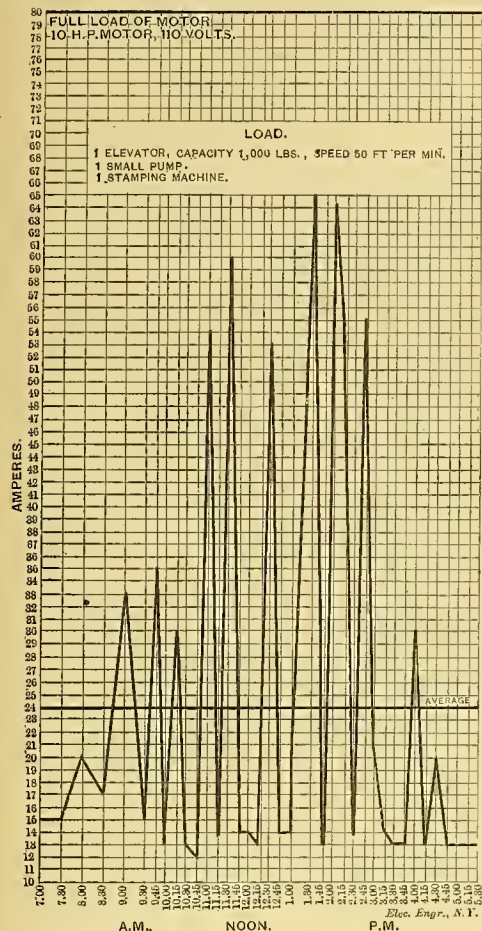

Average Load ..... 30 per cent. of Rated Capacity.  
Maximum Load ..... 81 per cent. of Rated Capacity.  
Average Load ..... 37 per cent. of Maximum Load.

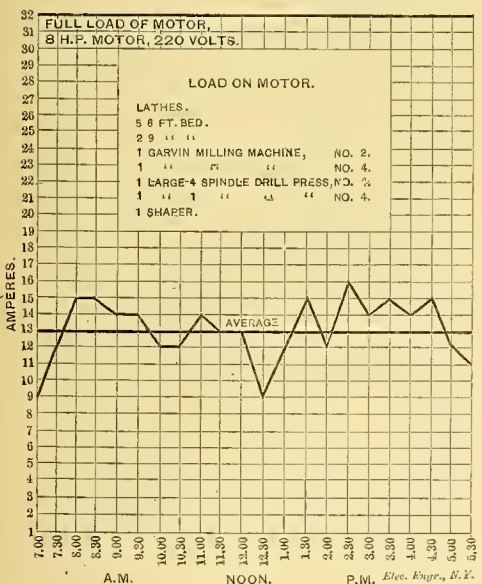

Average Load ..... 40 per cent. of Rated Capacity.  
Maximum Load ..... 50 per cent. of Rated Capacity.  
Average Load ..... 81 per cent. of Maximum Load.  
Shafting ..... 70 per cent. of Average Load.

A PROPER BASIS FOR DETERMINING ELECTRIC MOTOR RATES—LOAD DIAGRAMS.

on the maximum reading of an amperemeter in series with the motor. The station supplying the power reserves the right in their contract with the customer to change or modify the charge for power from time to time as any increase is shown by these readings.

To illustrate more clearly this "maximum reading system," I would refer to diagram No. 10, which is a fair average record. This represents the record of a 15 h. p. motor operating lithograph presses, etc., the maximum reading in this case being 75 amperes, or, approximately, 10 h. p. The user is given a 10 h. p. rate, which in this case happens to be \$60 per month, or a rate of \$6 per month per horse power based on maximum readings. As

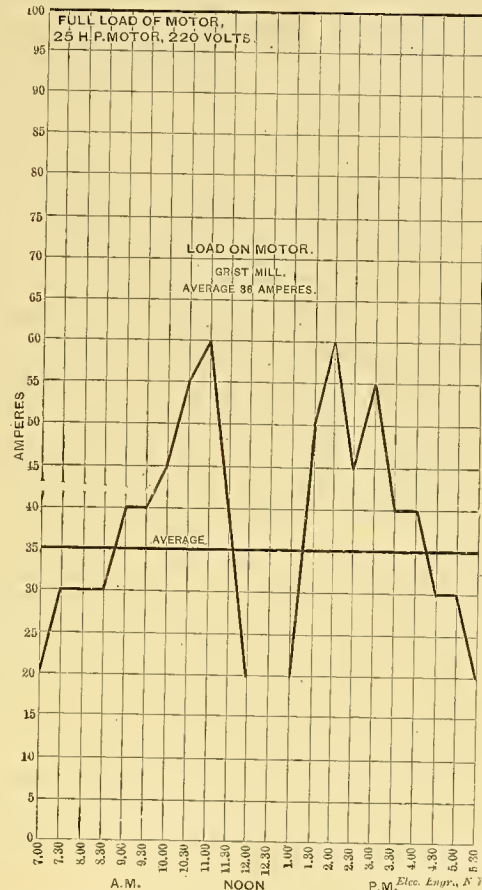

Average Load ..... 35 per cent. of Rated Capacity.  
Maximum Load ..... 60 per cent. of Rated Capacity.  
Average Load ..... 58 per cent. of Maximum Load.  
Shafting ..... 80 per cent. of Average Load.

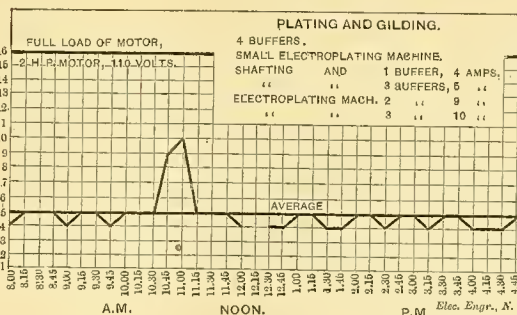

Average Load ..... 31 per cent. of Rated Capacity.  
Maximum Load ..... 63 per cent. of Rated Capacity.  
Average Load ..... 50 per cent. of Maximum Load.  
Shafting ..... 80 per cent. of Average Load.

A PROPER BASIS FOR DETERMINING ELECTRIC MOTOR RATES—LOAD DIAGRAMS.

A "maximum capacity" rate of \$6 per month per horse power pays the station \$13.80 per month per horse power for the power actually delivered. A "maximum reading" rate of \$6 per month per horse power pays the station \$9.37 per month per horse power for the power actually delivered.

\$13.80 per month per h. p. is certainly a tempting price for power, but it is open to some serious objections. In the first place, at this price, the electric motor, even with its much higher efficiency, cannot compete with the gas engine. A good gas engine uses about 20 feet of gas per hour per horse power, or about 5,200 cubic feet per month. Giving gas at \$1.50 per 1,000 (and in many places it is

much lower than this), the gas engine will deliver power at a cost of \$7.80 per month per horse power. We can, without much trouble, obtain the \$9.37 rate per month for a motor in competition with the gas engine, on account of its many and obvious advantages, but we can seldom obtain the \$13.80 rate. This maximum capacity rate also very much hampers the user in a selection of a motor, and the motor salesman, in order surely to effect a sale, is very apt to underrate the prospective load on the motor, as the customer is governed in his purchase of a machine much more by the monthly charge than by the first cost of the motor.

Another feature which must not be lost sight of is the fact that a motor user who has bought and paid for his machine becomes your permanent customer, his income being entirely derived from the product of the work of his motor. His bills for power you are also sure of collecting,

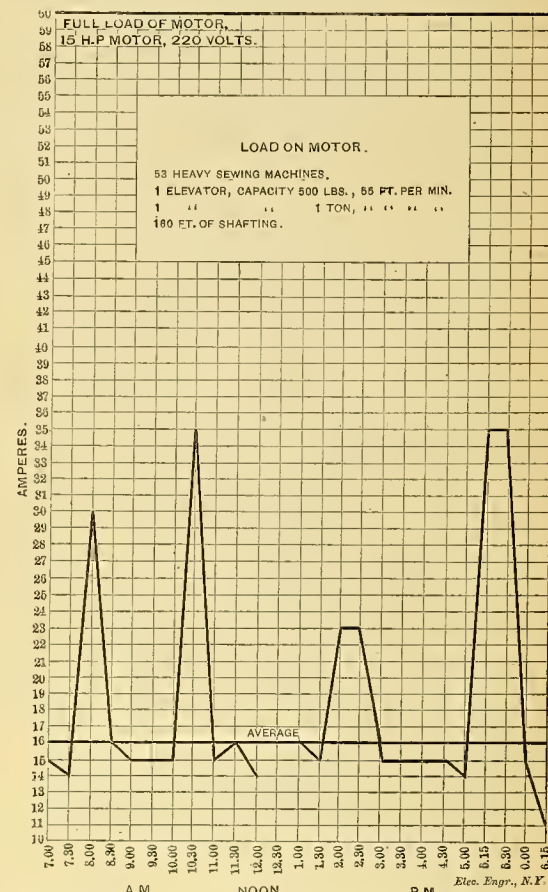

Average Load ..... 26 per cent. of Rated Capacity.  
Maximum Load ..... 58 per cent. of Rated Capacity.  
Average Load ..... 46 per cent. of Maximum Load.  
Shafting ..... 71 per cent. of Average Load.

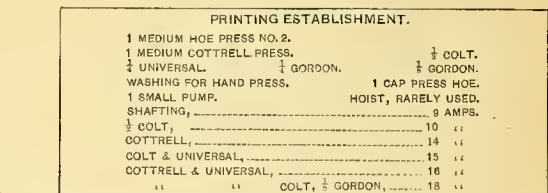

Average Load ..... 48 per cent. of Rated Capacity.  
Maximum Load ..... 75 per cent. of Rated Capacity.  
Average Load ..... 64 per cent. of Maximum Load.  
Shafting ..... 79 per cent. of Average Load.

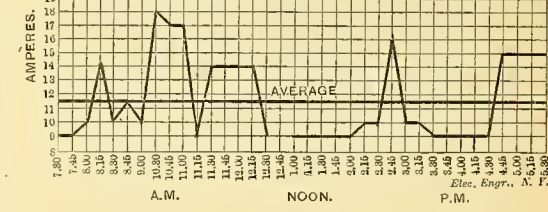

Average Load ..... 48 per cent. of Rated Capacity.  
Maximum Load ..... 75 per cent. of Rated Capacity.  
Average Load ..... 64 per cent. of Maximum Load.  
Shafting ..... 79 per cent. of Average Load.

A PROPER BASIS FOR DETERMINING ELECTRIC MOTOR RATES—LOAD DIAGRAMS.

for the moment his power is cut off his earning capacity ceases. The motor becomes to him an absolute necessity instead of a reasonable luxury, as is the case with many electric lights. Another very remarkable feature brought out by these diagrams is the fact that the average power consumed in doing serviceable work is but three-eighths of the total power used, and the remaining five-eighths (68 per cent.) is consumed in driving shafting. This enormous loss in shafting would indicate that the day may be not far distant when each machine will be equipped with its own direct-gear motor, and that the days of shafting and belting are numbered.

Continued on page 164.



# The Street Railway Gazette.

S. L. K. MONROE, - - - - - MANAGER.  
 E. V. CAVELL, - - - - - EDITOR.  
 EDWARD J. LAWLESS, - - - - - ASSOCIATE EDITOR.  
 W. L. S. BAYLEY, - - - - - MECHANICAL EXPERT.

## GENERAL OFFICES:

### CHICAGO:

8 LAKESIDE BUILDING.

AGENCIES } San Francisco, - - - 1222 Bush Street.  
 } Toronto (Canada), - - - 53 Magill Street.  
 Cable Address=TRAM, CHICAGO.

### Annual Subscription (Including Postage). Per Copy

United States, Canada.....	\$2.00.	.....	25c.
Great Britain, Ireland, India, Australia	10s.	.....	1s.
Germany.....	9mk. 75 pf.	.....	89pf.
France, Belgium, Switzerland.....	21fr. 95c	.....	Fr 1.10.
Spain.....	21ps. 95c.	.....	Ps 1.10.
Austria, Holland.....	6fl. 74c.	.....	55c.
Italy.....	12 lire.	.....	1½ lira.
Venezuela.....	12 bolivars.	.....	1½ bol.
Mexico.....	\$3.00.	.....	30c.

Annual Subscriptions in Argentine Republic, 2½ peso; Brazil, milreis; Turkey, 54 plasters.

[Entered at the Chicago post-office as second-class matter.]

\*\*\*

Matter for publication should reach the Chicago Office not later than the last day of each month. All communications should be addressed, THE STREET RAILWAY GAZETTE, Chicago, Ill.

## Announcements.

THE NINTH ANNUAL CONVENTION of the American Street Railway Association will be held at the Hotel Iroquois, Buffalo, N. Y., commencing on Wednesday, October 15th, 1890, at 10 A. M.

The convention headquarters of the STREET RAILWAY GAZETTE will be in parlor A, Iroquois Hotel, Buffalo, N. Y.

In order to get the benefit of the reduced rate for the return trip it will be necessary to have all certificates signed by the Secretary, or his clerk.

Delegates and visitors to the Buffalo convention are particularly requested to leave their cards at the headquarters of the STREET RAILWAY GAZETTE, Parlor A, Iroquois Hotel.

Exhibitors of street railway appliances will have every facility offered them for a display of their goods, ample room having been provided for their accommodation.

## An Electric Railway Association.

The magnificent work done by the American Street Railway Association, both at its conventions and through its very able and courteous secretary, Mr. Wm. J. Richardson, in bringing practical street railway men together from all parts of the country for an annual exchange of experiences, evidences the fact that from such intercourse material benefit is derived. That these benefits are eagerly sought after can be fully appreciated when the large attendance at the conventions is taken into consideration. Yet, of all the members' delegates to the A. S. R. A (the operating street railway companies, and not the officers, constituting the membership), probably very nearly seventy per cent are operating horse railroads, and are, consequently, more interested in matters pertaining especially to horse railroading than to any other system of street car propulsion or haulage.

On the other hand, there are a great many who

attend the conventions to whom matters relative to the docile horse or the frisky mule are of barely passing interest, while those pertaining to electricity command their earnest attention. The cable railway men are, numerically considered, largely in the minority, but they, even above their fellows, evince the deepest interest in all methods of street transportation. "Quick transit on our feeders to the trunk line is what we want," they say; "and we care not by what means our cars are moved, whether by horses, mules, electricity—anyhow, so long as they move along filled with passengers."

In view of these facts, and while bearing in mind that the annual convention of the A. S. R. A. is nigh at hand, let us suggest that the inception and establishment of a National Electric Railway Association would be hailed by many as the one thing needed. An association that would work hand in hand with the A. S. R. A., the representative of the tramway interests of North America, but composed solely of gentlemen using electricity as a motive power on their lines, would certainly be of immense value to street railway interests in general the world over, and doubly so if the members' delegates to their annual and semi-annual conventions should be composed of the practical men of the various electric companies, men who have had great and trying difficulties to face before successful and economical electric traction was established as well as it is to-day, and whose practical and economical methods were attained only after a most thorough and practical experience.

An association of this kind, which would devote all its energies to acquiring accurate information regarding the economic workings of electricity as a tractive power, would be of immense value to the fraternity. It could be arranged for such an association to be almost a part of the A. S. R. A., by intimate affiliation, members of the latter being entitled to membership in the former, conditional upon their using electricity as a motive power, etc. The conventions could be held at the same place and about the same time; in other words, let the rules governing the A. S. R. A. govern the Electric Railway Association—let the latter really be a part of the former.

We do not hesitate to express our belief that the perfecting of some such arrangement as suggested in the foregoing would, by very reason of the concentration of intelligent attention upon one particular subject, be far more prolific of good results than can possibly be attained by the appointment of individual committees at the annual convention of the A. S. R. A.

The suggestion is made for just what it may be worth, and in the hope that it may at least afford food for thought and reflection.

## Interest in Electricity.

The report of the ninth convention of the National Electric Light Association, recently held at Cape May, N. J., a synopsis of which appears in the present issue, evidences the fact that the interest taken in this new field for research is growing greater year by year, and has now reached that point where its importance is now fully established and its marvellous usefulness recognized in all the great marts of commerce and mechanical industries.

When we look back over the files of the electrical press we find that in 1888, only two short years ago, it occupied just twenty-four pages of reading matter for the whole convention issue of *The Electrical World*, that pioneer exponent of this great department of both science and art;

while in order to correctly report this ninth convention of the N. E. L. A. this year, thirty-two pages were devoted to the report—a great gain truly.

When it is generally conceded that even those gentlemen whose whole time is given to news gathering for the electrical fraternity acknowledge their inability to keep up with the procession, it can readily be seen what gigantic strides along the march of progress this grand industry must be taking.

## The Supply Men.

In every association, at some time or other, the question of the admission to membership therein of what are known by the generic term of "the supply men" comes up for discussion, and it has frequently been a matter of surprise to us that the discussion of the question generally evokes a hot debate, and creates a certain amount of bad blood.

In some associations these courteous and ubiquitous gentlemen are admitted to membership as "associates," having all rights to active membership, including the payment of an additional admission fee, or extraordinarily heavy annual dues, excepting that of the ballot box. In other words, "taxation without representation," the carrying out of that questionable policy, the general principle of which was the primary cause of certain tea chests being dumped overboard from a certain vessel in Boston in the reign of good King George, and which act eventually cost the forfeiture of the richest and most valuable jewel in His Britannic Majesty's diadem.

We regard it as eminently right and proper that, in the specific case of the American Street Railway Association—the membership should be composed in accordance with the constitution, which enacts that it shall be composed of the companies operating street railways—and not individuals—and in conversation with a majority of the supply men whose presence usually adds so much life and vim to the annual conventions, we must confess to an ability to discover one who honestly seeks membership in the association. That they shall be made welcome guests at the conventions is all they ask for—they do not desire to spend their time and money in an attempt to be legislators in the body politic. They attend the conventions for no other purpose than to make themselves and their wares known to their constituency, a most meritorious purpose, surely, and who can truthfully affirm that the presence of the supply men with their exhibits has not invariably lent additional interest to the conventions and given them almost a world wide prominence and publicity.

Taking up the problem of extending the influence of and increasing the membership of an association—when such is desired—we unhesitatingly aver that an immense power for good or ill in this direction is wielded by the supply men. Their good will means increased membership and enhanced importance—their ill will implies naught that is to be wished for or sought. In the course of their endless peripatinations from town to town they can carry good words or bad for an association to those whose names appear not on the roster of an association—influencing for or against, as the case may be. Their ill will is an intangible, yet, withal, tangible something, that no one wants, while the securing of their good words, the free advertising they give to an association, and the potent influence they undoubtedly wield, is a "consummation devoutly to be wished for."



### "For This Occasion Only."

For the first time in the history of the organization known as the New York Street Railway Association, its doors were thrown open to the supply men. All the street railway motor and over-head wire equipment companies were invited to send representatives to Rochester to make known to the members of the association the merits of their respective systems, and the remark made at the banquet by Mr. McNamara, president of the Albany Railway Company, that he "would not take \$500.00 for the knowledge he had acquired" at the convention, should be evidence *de facto* that the response of the electrical railway men to the invitation extended to be present, and their clear and lucid explanations of the workings and *modus operandi* of their systems, added in an intrinsic degree, to the value of the results derived from the holding of the convention.

While the invitation extended to these gentlemen "for this occasion only," was, undoubtedly primarily intended as an experiment, yet the deep interest taken by the association in what they had to say, inclines us to the belief that many more similar invitations will be extended for them to attend future conventions.

### Buffalo Convention Announcement.

The following communication from Secretary Richardson of the A. S. R. A., is self-explanatory:

OFFICE OF THE AMERICAN ST. RAILWAY ASSOCIATION,  
CORNER ATLANTIC AND THIRD AVENUES,

BROOKLYN, N. Y., Sept. 15, 1890.

Dear Sir:—The Ninth (Regular) Annual Meeting of the American Street Railway Association will be held at the Hotel Iroquois, in the city of Buffalo, N. Y., the third Wednesday in October (the 15th), 1890, at 10 o'clock A. M.

There is no doubt that this meeting will prove fully as interesting as those which have preceded it, and that there will be a large attendance of delegates. It is believed that these results will be secured by the following

#### PROGRAMME OF THE MEETING.

FIRST—*Reports of Committees.* Special Committees have been appointed and will report on the following varied topics: "A Perfect Street Railway Horse;" "A Year's Progress of Cable Motive Power;" "Electric Motive Power Technically Considered;" "Novel Schemes for the Development of Street Railways, and Public and State Treatment of Corporations—No. 2."

The question as to the advisability of the meetings of the Association being held in executive session will also be considered.

SECOND—*Exhibition of Street Railway Supplies.* As usual, this interesting feature of the meeting will receive attention, and every convenience afforded for the exhibition and inspection of this important department of the street railway business. The Buffalo Street Railway companies have provided ample facilities, and invitations have been extended to inventors and dealers generally. It is expected they will embrace the opportunity to display the latest improvements in their various lines.

THIRD—*Local Entertainment.* The Buffalo Street Railway companies have arranged two special excursions for the pleasure of all who attend the convention. 1. A tour of inspection over the most attractive portions of the Buffalo Street Railway system, including a visit to the park, public institutions and other points of interest. 2. A special train along the river bank to the famous cataract, affording on the way fine views of the lake, harbor, river current, Grand Island and smaller islands, Tonawanda (the greatest lumber market in the world), rapids above the falls, Cantilever Bridge, and the Horse-shoe Fall from "Fall's View," on the Canadian side of the river. Canadian Park will then be visited, and the upper Suspension Bridge crossed on foot. An hour will be devoted to the American Falls, Prospect Park and Goat Island; after which the Niagara Falls & Suspension Bridge Street Railway company will transport the delegates to the lower Suspension Bridge and the Whirlpool Rapids, reached by the inclined Railway to "Rapid's View." The final feature will

be a trip to Lewiston, opposite the noted Brock's Monument, through the wild and rugged scenery of the Niagara Gorge, on a special train of observation cars. The return to Buffalo will be in time to enable delegates to leave for their homes on the evening trains.

FOURTH—*Reduced Rates of Fare.* The New England Passenger Committee, Trunk Line, Central Traffic and Southern Passenger Associations have united in granting the courtesy of the special rate of a fare and one-third for the round trip, to all who attend the meeting, including friends and members of the families of gentlemen in attendance at the meeting. The territory to which the concession applies covers nearly all of the United States, except the Western and Pacific Coast States. Doubtless all delegates will avail themselves of this reduced rate where possible. For the guidance of delegates, the rules governing reduced rates, strict conformity with which is required, are given.

FIRST—Each person must purchase (not more than three days prior to the date of the meeting) a first-class ticket (either unlimited or limited) to Buffalo, for which he will pay the regular tariff fare, and upon request, the ticket agent will issue to him a certificate of such purchase, properly filled up and signed by said ticket agent.

SECOND—Where the journey is made over more than one line, it may be necessary for the passenger to purchase separate local tickets, and procure certificates thereof for each of the lines over which he travels in going to the meeting, as some of the lines do not honor the certificate of any other line. Passengers should ascertain from the ticket agent what portion (if not all) of their journey can be covered by the certificate procurable of him, and purchase tickets and secure certificates filled in accordingly. In case tickets on certificate plan cannot be procured at the starting point, the person will purchase to the nearest point where such tickets can be obtained, and there repurchase through to Buffalo, requesting a certificate properly filled out by the agent at the point where repurchase is made.

THIRD—Tickets for the return journey will be sold by the ticket agents at the place of meeting at one-third the highest limited fare to those only who hold certificates signed by the ticket agent at point where through ticket to the place of meeting was purchased, and countersigned by the Secretary of the Convention, certifying that the holder has been in attendance upon the convention.

FOURTH—It is absolutely necessary that a certificate be procured, as it indicates that full fare has been paid for the going journey, and that the person is therefore entitled to the excursion fare returning. It will also determine the route by which the ticket for return journey should be sold, and without it *no reduction will be made*, as the rule of the Associations is that "No refund of fare can be expected because of failure of the parties to obtain certificates."

FIFTH—Tickets for return journey will be furnished only on certificates procured not more than three days before the meeting assembles, nor later than two days after the commencement of the meeting, and will be available for continuous passage only; no stop-over privileges being allowed on tickets sold at less than full fares. Certificates will not be honored unless presented within one day after the date of the adjournment of the convention. The certificates are not transferable, and the signature affixed at the starting point, compared with the signature to the receipt, will enable the ticket agent to detect any attempted transfer.

N. B. Please read carefully the above instructions, and be particular to have the certificate properly filled out and certified by the railroad agent from whom you purchase your going ticket or tickets. *Tickets and certificates should be obtained at least thirty minutes before the departure of trains.*

A certificate is void if altered, if not presented within prescribed dates, if not signed by the Secretary of the Association, or if blank spaces on the going side are not filled out signed and stamped by agent of the line at point from which passenger started.

The Secretary suggests to all who will attend the meeting, and who desire to transact business at any other city *en route*, to arrange to do so on the trip to Buffalo, as the going ticket will, of course, carry with it, in most cases, stop-over privileges; while the return ticket does not.

FIFTH—*Attendance of Ladies.* Delegates to the Convention, being accompanied by their wives and daughters has become an established custom; and each year grows in popular favor. The pleasure of their society, and their own enjoyment, is most manifest on the excursions and at the banquet. As heretofore, every arrangement will be provided for the participation of ladies in the excursions and the banquet.

SIXTH—*The Banquet.* The Annual Dinner will take place on Thursday evening, the 16th prox., at the Hotel Iroquois. Each company, a member, is entitled to the admission of two persons to the Banquet free. Each additional gentleman will be charged ten dollars; ladies' tickets, five dollars each. In order to facilitate the Executive Committee, will you please inform the

Secretary immediately upon receipt of this notice of the number that will be present from your company, enclosing the additional amount covering the number in excess of the two to which the company is entitled free, that definite arrangements as to the number that will attend the banquet may be promptly made.

The Hotel Iroquois is a new, thoroughly fire-proof building, and as a modern hostelry takes rank with the finest in the country. No pains will be spared by the proprietors to have all the details connected with the meeting satisfactory, and they will devote every attention to the comfort of guests. It is suggested that delegates secure accommodations as early as possible.

Will you please acknowledge receipt of this letter at your earliest opportunity, stating whether you expect to be present at the meeting, and on the enclosed delegate's card fill in the names of those who will attend from your company, and return it with your letter of acknowledgment in the accompanying envelope.

Awaiting your prompt reply, I am,

Sincerely yours,

WM. J. RICHARDSON, Secretary.

### Electricity to the Rescue.

During the bathing hour on the second day of the convention, when the surf was running tremendously high, a lady and her escort (names unknown) suddenly found themselves beyond their depth, while the receding tide was bearing them fast out to sea. In attempting to rescue his companion, the escort found that her arms were clasped around his throat with a vise-like grip. He cried aloud for help, which was heard by J. P. McQuade and W. A. Stadelman, who bravely struck out for the scene of action, and after an heroic battle with the waves succeeded in rescuing the pair. Mr. McQuade was the first to reach the drowning pair, but found that they were about to prove too much for him. Burt Stadelman, however, is a superb specimen of athletic manhood, and holding the woman well up out of water he at last succeeded in getting her to land.

WEST CHICAGO STREET RAILROAD Co.

89 WEST WASHINGTON STREET.

CHICAGO, September 15, 1890.

Dear Sir:—This company is in receipt of numerous inquiries about the publication of an advertising scheme in book form, wherein its name has been used to secure patronage.

There is no authority whatever for such publication, so far as this company is concerned; but to the contrary, the project has its most emphatic disapproval.

The whole affair is an evident attempt to defraud the public in the company's name. "T. Harvey Weeks," who is announced as "superintendent" of the enterprise, is unknown to this office, and believed to be an imaginary being, for the reason that the persons using the name, refuse to reveal his whereabouts, occupation, or business connections, if any.

The company intends to prosecute all concerned in the attempted fraud, and takes this means of guarding the business public against them.

Respectfully,

John B. Parsons,

Vice-President and Gen'l Manager.

N. Y. L. E. & W. Ry. Co.

OFFICE OF THE VICE-PRESIDENT.

NEW YORK, August 6, 1890.

NOTICE:—Mr. W. C. Rinearson is hereby appointed General Passenger Agent of this company. Appointment to take effect at once.

S. M. FELTON, Jr.,

Vice-President.

OFFICE OF THE GENERAL PASSENGER AGENT.

NEW YORK, September 10, 1890.

GENERAL NOTICE NO. 14.

Mr. D. I. Roberts is hereby appointed Assistant General Passenger Agent of this company, in charge of business west of Buffalo and Salamanca, with headquarters at Chicago, taking effect September 15, 1890.

W. C. RINEARSON,

Approved:

Gen'l Passenger Agent.

S. M. FELTON, Jr.,

First Vice-President.



Continued from page 161.

As a concluding reference to these diagrams, let me call your attention to diagram No. 3, in which a condition presents itself with which you are familiar in theory, but which has, I believe, never before been practically illustrated, namely, the counter E. M. F. in the armature of a shunt wound motor driving a spur gear elevator. When the elevator is coming down with a load the counter E. M. F. runs above the E. M. F. of the supplying circuit, and therefore the motor becomes a producer instead of a consumer, and thus acts as a break to retard the too rapid descent of the elevator.

Diagram No. 3 represents the record of a seven and one-half horse power motor in a wine merchant's store, operating an elevator, a small piston water pump and wine pump. The water pump is in continuous operation, the wine pump and elevator being only used intermittently. The current consumed in the shafting and water pump, which constitute the continuous load, is 14 amperes. The difference between this 14 amperes and the several readings below that amount, shows the amount of current generated by the motor when the elevator is coming down. As this class of elevator is largely used, this peculiar fact becomes an item of considerable importance to the central station, and is also a strong argument in favor of a constant potential power circuit, as only on this circuit can these conditions be obtained.

I had hoped to prepare some diagrams of motors on series or arc light circuits for comparison with the records

ently delighted with his service and perfectly satisfied with the cost of his power, and I have the assurance of the electric light company supplying the power, that they would be glad to load their plant under the same terms given this customer.

MR. EDGAR: I have listened with a great deal of interest to this article of Mr. Lufkin, because I have talked the matter over with him to a great extent, and I know that a great many of his curves were made from motors running from our station. Our efforts in the last year and a half to two years have been to sell motors entirely by meter, selling it by the absolute horse power hour; and of the last 400 horse power which have been used in Boston, I should think that 250 are now paying for their current entirely by meter at so much a horse power hour. We make a nominal charge of 10 cents an hour per horse power, making discounts from this down to 40 per cent., so that the minimum rate is 6

charged for 10 merely because he happened to put in a 10 rather than a 5.

A paper entitled "Standards of economy in the generation of power" was then read by Mr. Swetland, which was followed by a few remarks on triple expansion engines, by Mr. Ed. F. Williams, of Illinois. The report of the Committee on Revision of the Constitution was called up, Mr. M. J. Francisco, the chairman, read the proposed new constitution as follows:

CONSTITUTION OF THE NATIONAL ELECTRIC LIGHT ASSOCIATION.

ARTICLE I.—NAME.

This Association shall be entitled the National Electric Light Association.

ARTICLE II.—OBJECT.

The object of this Association shall be to foster and protect the interests of those engaged in the commercial production of electricity for conversion into light, heat or power.

ARTICLE III.—MEMBERSHIP.

SECTION I.—Members shall be divided into three classes—Active, Associate and Honorary. Active members only shall be entitled to vote and take part in the deliberations of the Convention, and shall be corporations or individuals engaged in the business of producing and supplying electricity for light, heat or power, for commercial or public use.

SEC. 2.—In the case of a corporation, the membership may stand in the name of the company, and such company shall have the right to be represented at any meeting of the Association by any of its officers or directors, or by its regularly employed manager or superintendent.

SEC. 3.—Associate members shall be Electricians, Electrical or Mechanical Engineers, Manufacturers and individuals who are otherwise directly or indirectly interested in advancing the use of electricity, and shall have the right of attending all meetings of the Association except executive sessions.

SEC. 4.—Honorary members shall include those already elected as such, and such other persons as may be elected upon the unanimous recommendation of the Executive Committee and approved by a two thirds vote of the Association.

ARTICLE IV.—OFFICERS AND EXECUTIVE COMMITTEE.

SEC. 1.—The officers of the Association shall be a President, two Vice-Presidents, an Executive Committee of nine members, and a Secretary and a Treasurer, who shall be elected as specified in this Constitution.

SEC. 2.—The President and Vice-Presidents shall be elected to serve one year from the first of the month following the date of their election, and shall be active members. The President shall act as Chairman of the Executive Committee during his term of office. He shall not be eligible to re-election for two years after his first term has expired.

SEC. 3.—The Executive Committee shall be chosen from among the active members. The first Executive Committee elected after the adoption of this Constitution shall be divided into three classes. Class one shall serve for the period covered by three Conventions; class two for two Conventions; and class three for one Convention from the first of the month following their election, after which three members of the Committee shall be elected each Convention to serve for three succeeding Conventions from the first of the month following their election.

SEC. 4.—The offices of Secretary and Treasurer may be filled by the same person. He shall not serve as a member of any committee; shall be eligible for re-appointment and election without limit; shall give a security bond in such sum and with such qualifications as the Executive Committee may determine from time to time, and shall perform such duties as said Committee may direct, subject to their approval.

SEC. 5.—The Secretary and Treasurer shall be nominated by the President and ratified by the Executive Committee. He shall serve for one year from the first of the month following the date of the President's election. He may be an active or associate member.

SEC. 6.—The Executive Committee shall be the governing body of the Association, and shall manage its affairs, pass upon all applications for membership, subject to this Constitution and such special rules or regulations as may be adopted by the Association from time to time, and five members of the Committee shall constitute a quorum.

ARTICLE V.—MEETINGS.

The annual meeting of this Association shall be held in February, and a semi-annual meeting may be held in August of each year, at such places as the Association shall determine, and on such dates as may be determined by the Executive Committee.

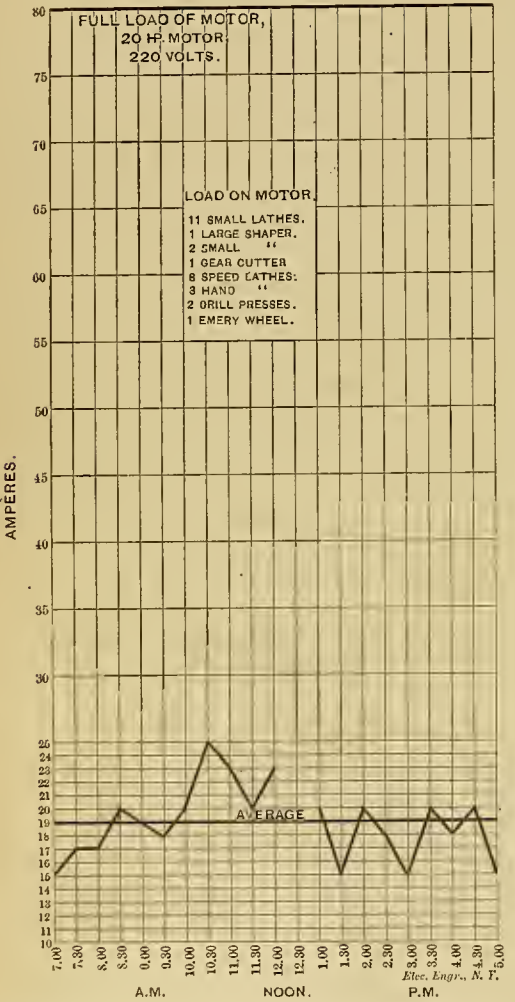

Average Load..... 24 per cent. of Rated Capacity.  
 Maximum Load..... 31 per cent. of Rated Capacity.  
 Average Load..... 75 per cent. of Maximum Load.  
 Shafting..... 79 per cent. of Average Load.

No. 8. A PROPER BASIS FOR DETERMINING ELECTRIC MOTOR RATES—LOAD DIAGRAMS.

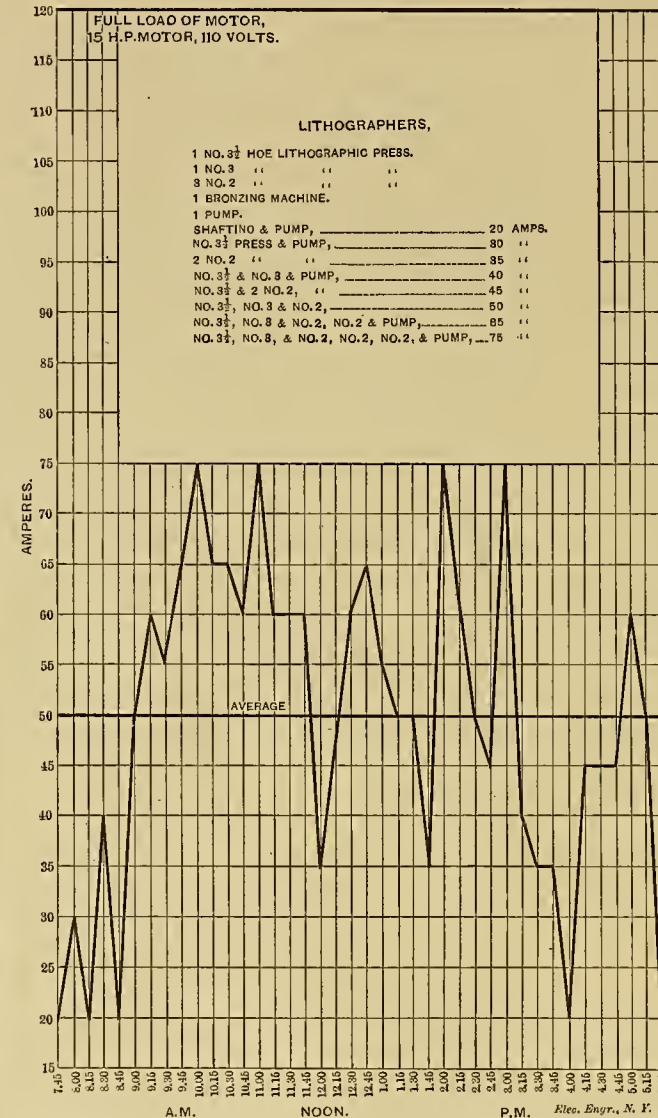

Average Load..... 42 per cent. of Rated Capacity.  
 Maximum Load..... 62½ per cent. of Rated Capacity.  
 Average Load..... 67 per cent. of Maximum Load.  
 Shafting..... 40 per cent. of Average Load.

No. 10. A PROPER BASIS FOR DETERMINING ELECTRIC MOTOR RATES—LOAD DIAGRAM.

here submitted, and thereby illustrate graphically the advantages of the constant potential circuit for power distribution. Want of time has, however, prevented this.

In conclusion, let me read you some extracts from a letter received in March last from a prominent manufacturing corporation using 75 or 80 horse-power in motors in their work shops.

"We are running with one motor a large four ton Graves' elevator and several wood-working machines, such as planers, cross cut saws, etc. In our machine department the several motors run several lines of shafting, independent of each other. In this department we run heavy planers lathes, drill presses, shapers, slotters, gear cutters and other machinery necessary to a complete machine shop. A motor in our department for fine wood work furnishes power for the various machines necessary to the manufacture of articles needing turning lathes, gig saws, rip-saws, etc.

"In our experimental department and show room we use a smaller motor, set with the necessary speed reducing pulleys and belts upon a movable frame. This we roll from place to place as convenience dictates. All of these motors are giving us unqualified satisfaction, and we would not willingly return to direct steam engine power."

This company is being supplied with power by the local electric light company, on a basis of \$50 per year per horse power based on maximum readings. The user is appar-

cents per hour, the average being between 7 and 8. This is irrespective of the size of the motor. It depends entirely on the number of horse power hours per day as compared with the maximum which that motor can generate. In other words, a 1 h. p. motor might get just as good a rate as a 30 h. p. motor provided it used as much as its maximum, as if it were a larger motor. I think that the question of charging by the nominal capacity of the motor is something I never heard of. Our station has never tried to charge in that way. It has always charged by the maximum load of the motor. In other words a man could put in any motor he pleased; he would simply be charged, when he was charged by contract, the maximum power which that motor used at any time by means of the amperemeter. If a person was going to use 5 h. p., and he was inclined to put in a 10 h. p. motor, we were very glad to have him do so, and we would only charge for the 5 h. p., if he used only 5 h. p. I never heard of a case where a person was

from the first of the month following their election.



ARTICLE VI.—QUORUM.

Fifteen active members of the Association shall constitute a quorum for the transaction of business.

ARTICLE VII.—DUES.

The annual dues of active members shall be twenty-five dollars and associate members twenty dollars, payable in advance, and shall cover the calendar year. Members in arrears for dues shall not exercise the privileges of membership. Any member in arrears for one year's dues shall be dropped from the rolls, and if he is reinstated he will be required to pay his dues for the year in which his membership lapsed.

ARTICLE VIII.—ELECTION OF OFFICERS.

All officers shall be elected by ballot at the annual meeting of the Association. Vacancies in office may be filled by the Executive Committee to cover the term until the next annual meeting of the Association.

ARTICLE IX.—PERMANENT OFFICE.

A permanent office of the Association shall be established in the city of New York, and shall be located, furnished and governed in such a manner as the Executive Committee may from time to time determine.

ARTICLE X.—PARLIAMENTARY RULES.

Roberts' Rules of Order shall be the governing parliamentary law of the Association in all cases not definitely provided for by this Constitution.

ARTICLE XI.—VOTING AND PROXIES.

SEC. 1.—The roll call shall be ordered on the demand of ten members on any question before the Association. Unless ordered otherwise as specified in this Constitution, all voting shall be by voice.

SEC. 2.—Voting by proxy shall not be allowed at any meeting of the Association or any of its Committees.

ARTICLE XII.—AMENDMENTS.

SEC. 1.—Amendments to this Constitution shall be presented in writing, and shall be referred to a Committee to be elected by the Association before being acted upon. A two-thirds vote of all members present, entitled to vote, shall be necessary for their adoption.

SEC. 2.—No amendment shall be voted upon by the Convention at which it is introduced.

On motion of Mr. M. J. Francisco it was resolved that the report of the Committee on the Revision of the Constitution be accepted and adopted, and the new Constitution to take effect January 1, 1891, and on motion of S. A. Duncan the discussion of the resolution was made the special order of business at 11 a. m. Thursday, after which the meeting adjourned.

THURSDAY'S SESSION.

Pursuant to adjournment of the preceding day the discussion of the report of the Committee on Revision of the Constitution came up as a special order at 11 A. M.

After a hot debate, which lasted for fully an hour or two, in which the question of the admission of and privileges to be accorded to Associate members appeared to be the *casus-belli*, the Constitution and By-Laws, as finally adopted are as follows:—

ARTICLE I.—NAME.

This Association shall be entitled the National Electric Light Association.

ARTICLE II.—OBJECT.

The object of this Association shall be to foster and protect the interests of those engaged in the commercial production of electricity for conversion into light, heat or power.

ARTICLE III.—MEMBERSHIP.

SECTION I.—Members shall be divided into three classes—active, associate and honorary. Active members only shall be entitled to vote, and shall be corporations or individuals engaged in the business of producing and supplying electricity for light, heat or power for commercial or public use.

SEC. II.—Associate members shall be electricians, electrical or mechanical engineers, manufacturers, corporations and individuals who are otherwise directly or indirectly interested in advancing the use of electricity, and shall have the right of attending all meetings of the Association except executive sessions, and shall have the right to discuss papers read before the Association.

SEC. III.—Honorary members shall include those already elected as such, and such other persons as may be elected upon the unanimous recommendation of the Executive Committee and approved by a two-thirds vote of the Association.

SEC. IV.—In the case of a corporation, the membership may stand in the name of the company, and such company shall have the right to be represented at any meeting of the Association by any of its officers or directors, or by its regularly employed manager or superintendent.

SEC. V.—No individual actively associated with a corporation holding an active membership shall become an active member individually, unless he shall own or operate a central station plant individually.

ARTICLE IV.—OFFICERS AND EXECUTIVE COMMITTEE.

SECTION I.—The officers of the Association shall be a president, two vice-presidents, an executive committee of nine members, and a secretary and a treasurer, who shall be elected as specified in this Constitution.

SEC. II.—The President and vice-presidents shall be elected to serve one year from the first of the month following the date of their election, and shall be active members. The President shall act as chairman of the executive committee during his term of office. He shall not be eligible to re-election for two years after his first term has expired.

SEC. III.—The executive committee shall be chosen from among the active members. The first executive committee elected after the adoption of this Constitution shall be divided into three classes. Class one shall serve for the period covered by three conventions, class two for two conventions, and class three for one convention, from the first of the month following their election, after which three members of the committee shall be elected at each Convention, to serve for three succeeding conventions from the first of the month following their election.

SEC. IV.—The offices of secretary and treasurer may be filled by the same person. He shall not serve as a member of any committee; shall be eligible for re-appointment and election without limit; shall give a security bond in such sum and with such qualifications as the executive committee may determine from time to time, and shall perform such duties as said committee may direct, subject to their approval.

SEC. V.—The secretary and treasurer shall be nominated by the president and ratified by the executive committee. He shall serve for one year from the first of the month following the date of the president's election. He may be an active or associate member.

SEC. VI.—The executive committee shall be the governing body of the Association, and shall manage its affairs, pass upon all applications for membership, subject to this Constitution and all such special rules or regulations as may be adopted by the Association from time to time, and five members of the committee shall constitute a quorum.

ARTICLE V.—MEETINGS.

The annual meetings of this Association shall be held in February, and a semi-annual meeting may be held in August of each year, at such places as the Association shall determine, and on such dates as may be determined by the executive committee.

ARTICLE VI.—QUORUM.

Fifteen active members of the Association shall constitute a quorum for the transaction of business.

ARTICLE VII.—DUES.

The annual dues of active members shall be \$25 and associate members \$20, payable in advance, and shall cover the calendar year. Members in arrears for dues shall not exercise the privileges of membership. Any member in arrears for one year's dues shall be dropped from the rolls, and if he is reinstated he will be required to pay his dues for the year in which his membership lapsed.

ARTICLE VIII.—ELECTION OF OFFICERS.

All officers, except the secretary and treasurer, shall be elected by ballot at the annual meeting of the Association. Vacancies in office may be filled by the executive committee to cover the term until the next annual meeting of the Association.

ARTICLE IX.—PERMANENT OFFICE.

A permanent office of the Association shall be established in the city of New York, and shall be located, furnished and governed in such a manner as the executive committee may from time to time determine.

ARTICLE X.—PARLIAMENTARY RULES.

Roberts' Rules of Order shall be the governing parliamentary law of the Association in all cases not definitely provided for by this Constitution.

ARTICLE XI.—VOTING AND PROXIES.

SECTION I.—The roll call shall be ordered on the demand of 10 members on any question before the Association. Unless ordered otherwise, as specified in this Constitution, all voting shall be by voice.

SEC. II.—Voting by proxy shall not be allowed at any meeting of the Association or any of its committees.

ARTICLE XII.—AMENDMENTS.

SECTION I.—Amendments to this Constitution shall be presented in writing, and shall be referred to a committee to be elected by the Association before being acted upon. A two-thirds vote of all members present, entitled to vote, shall be necessary for their adoption.

SEC. II.—No amendment shall be voted upon by the Convention at which it is introduced.

The Convention took a recess from 2.15 P. M., until 3.30 P. M.

THURSDAY AFTERNOON.

The following named gentlemen were appointed by the President to serve on the Columbian Exposition Committee:—

P. H. Alexander, Oldtown Electric Light Co., Oldtown, Maine; George H. Roe, San Francisco Electric Light Co., San Francisco; S. J. Hart, Louisiana Electric Light Co., New Orleans, and Mr. Edwards, of the Charleston Electric Light and Power Co., Charleston, S. C.

The reports of the Secretary and Treasurer, were then read by Secretary Foote, as follows:—

REPORT OF THE SECRETARY—MEMBERSHIP.

Active members, dues paid.....	79
Active members, dues unpaid.....	28
—	—
Total active members.....	107
Associate members, dues paid.....	123
Associate members, dues unpaid.....	34
—	—
Total associate members.....	162
Total membership, July 1, 1890.....	269
Total membership, Jan. 1, 1890.....	259
Gain in membership for the six months.....	10

REPORT OF THE TREASURER.

Balance Jan. 1, 1890.....	\$610.17
Received from Jan. 1 to July 1.....	3,020.00
Total to be accounted for.....	\$3,630.17
Expended from Jan. 1 to July, per approved vouchers on file.....	2,396.57
Balance in bank, July 1, 1890.....	1,233.60
Total accounted for.....	\$3,630.17

On motion of Mr. Garratt the report of the secretary and treasurer was received and spread upon the minutes.

The report of the Finance Committee was then called for, when Mr. Garratt stated that he had to go down to the train, and obtained permission from the chair to make a statement, which was as follows:—

Mr. GARRATT: At the Kansas City Convention there was a committee appointed to draft resolutions on the death of two of our members. I caused two copies of these resolutions to be engrossed, one in the name of Mr. Goodyear and the other in the name of C. McIntire which I will read:

Preamble and resolutions adopted by the National Electric Light Association at its Cape May Convention, August 19-21, 1890.

The Special Committee, composed of the following undersigned members, appointed at the Kansas City Convention of this Association, in February of this year, unanimously recommend the adoption of the following preamble and resolutions, to wit:

Whereas, In the course of Divine Providence our fellow member has been taken from our midst by death, and

Whereas, It is our heartfelt desire to express individually and collectively our sorrow, and to extend to those who are endeared him by the ties of kindred our sympathy; be it therefore

Resolved, That in the death of our fellow-member, Mr. Miles W. Goodyear, this association has sustained the loss of one whose integrity of character and many noble qualities have endeared his memory to us, and whose well-directed efforts in the arts and sciences pertaining to electrical industries, as well as his long and honorable connection with this Association, have earned our esteem; and be it further

Resolved, That we hereby extend to the members of his family our deepest sympathy and condolence; and be it finally

Resolved, That the Secretary is hereby instructed to spread these resolutions upon the minutes of this Association, and to transmit a true copy thereof to his family.

F. E. DEGENHARDT, Chairman.  
WILLIARD L. CANDEE,  
ALLAN V. GARRATT.

Committee.

The report was received and the committee discharged.

Mr. Huntley, Chairman of the Executive Committee, upon being called upon for a report, said that the committee had no written report but that its work had been seen during the sessions of the Convention.

Messrs. T. C. Smith, De Camp, Armstrong, Long and Alexander were appointed a Committee on Nominations for Executive Committee.

Mr. John A. Seely, Chairman of the Finance Committee, then reported as follows:—

The books of accounts have been audited to July 1, 1890, and have been found to be correct. The financial statement is as follows:

Balance December 31, 1889.....	\$ 610 17
Receipts.....	3,020 00
Disbursements.....	2,396 57
Balance June 30, 1890.....	1,233 60

During the six months covered by this report \$725.02 of bills contracted previous to December 31, 1889, have been audited and paid. This shows the disbursements for bills contracted from December 31, 1889, to June 30, 1890, \$1,671.55.

Two volumes of reports of the tenth and eleventh conventions have been published and are now ready for delivery. By resolution of the executive committee, the secretary, Mr. Garratt, was authorized to contract for advertisements to be printed in each volume. Under this arrangement the cost of publishing these two volumes, Vol. VII and Vol. VIII, 500 copies of each bound in cloth, is as follows:

Printing.....	\$1,039 80
Binding.....	140 00
Wrapping, for mailing and Sundries.....	10 00

Income from advertising..... \$1,139 80

Balance, net expense to association..... 213 20

In looking over the accounts the committee has noted one change in the business methods of the association that in its opinion can be made with advantage. It relates to the payment of expenses incurred by the committees. Your committee recommends that hereafter, whenever a committee is appointed, the executive committee shall fix the maximum amount it will allow for the expenses of such committee and notify its chairman that vouchers for the expenses of his committee will be allowed within the limit specified, and no more.



The committee find that the accounts of the association are being kept in single entry, and without a ledger of accounts. Your committee recommends that the secretary be directed to open a new set of books of date of July 1, 1890, to be kept in double entry system, and that the following be among the ledger accounts to be kept:

*Receipts:* Active members' dues, associate members' dues, sale of proceedings, advertising in proceedings, donations, sundry sources.

*Disbursements:* Rent, salaries, postage and telegrams, printing and stationery, publishing proceedings, committees (an account for each), furniture, sundries.

This portion of the executive committee's report was received and filed and the recommendations were ordered carried into effect.

On behalf of Mr. Joseph E. Lockwood Chairman, Mr. Wilmerding read the following:

REPORT OF THE COMMITTEE ON UNDERGROUND CONDUITS AND CONDUCTORS.

GENTLEMEN: At the Kansas City Convention, held last February, the following members were appointed a committee on Underground Conduits and Conductors, viz.:

J. E. Lockwood, of Detroit, Mich.  
C. H. Wilmerding, of Chicago, Ill.,  
S. S. Wheeler, of New York.  
T. C. Smith, of Philadelphia, Pa.  
D. E. Evans, of Baltimore, Md.

Your Committee now desire to report that they have perfected a plan of work, but before carrying out same desire the opinion of the Association, and any suggestion that members, especially interested, may desire to make.

The plan of work adopted is, first to secure from each electric light or power company, operating any high tension underground conductors a full description of the conduit and conductors in use, the character of the current used, and how long same has been in use, which information, when classified and tabulated, will indicate plainly the condition of the subject at the present date, and will give us a starting point to work from. We then intend to secure the co operation of these companies in our next step, which will be to have each company keep account of the cost of maintenance and repairs to the conduits and conductors, and of all changes or additions thereto, also of the average hours per day the system is operated; this information when classified and tabulated will show the cost of operating underground conductors, and if regularly reported to the committee will show whether or not progress is being made in this direction, and whether the systems in use are likely to prove permanently successful or to finally fail.

It is also designed to include in these reports a list of all grounds, burn outs, etc., and their causes, with suggestions looking to the removing of said causes.

The committee would of course keep private the names of all companies furnishing such information, simply reporting same in tabulated form. These reports would be invaluable to companies operating such conductors, as they would have, not only their own experience to improve upon but also that of all other companies operating underground conductors.

In regard to the details of the plan of work proposed, we have decided on first obtaining the following information, viz.:

*Conduits,*

1. A full description of the conduit used, kind of man or handholes, provision for taking off service, etc.
2. Mileage of conduits laid and in use.
3. Mileage of duct laid and in use.
4. Number of manholes.
5. Number of handholes.
6. Length of time in use.

*Conductors.*

1. Description of the conductor in use, stating size of conductor, kind and thickness of insulation, and if insulation is covered, in what manner.
2. How long same has been laid and in use.
3. Mileage of conductors laid and in use.
4. Average hours per diem same is operated.
5. Electromotive force and character of current used.

The above information would give us a good basis to work on, we would then endeavor to have each company operating high tension underground conductors, keep the following records, and report same regularly to the committee, just before each Convention, so that same could be properly classified, tabulated and recorded.

RECORDS.

*Conduits.*

- Mileages of conduit laid and in use.
- Mileages of duct laid and in use.
- Number of manholes.
- Number of handholes.
- Number of services taken direct from conduit.
- Cost of maintenance per month.
- Cost of repairs per month.
- Description of any new work done since last report.
- Trouble with conduit man or handholes and suggestions as to how same can be remedied.

*Conductors.*

- Mileage of conductors laid and in use, number of circuits and mileage of each.
  - Cost of maintenance per month.
  - Cost of repairs per month.
  - Number of burn outs and causes.
  - Troubles of other kinds and causes.
  - Suggestions as to how troubles can be remedied.
  - Average hours per diem circuits are operated.
  - Voltage and character of current used.
  - Changes or new work.
  - Mileage of conduit or conductors abandoned.
  - Mileage of conduit or conductors added since last report.
- The above reports would, of course, be separately classified for different kinds of conduits, conductors and currents.

Your committee think that these records should be kept continuously and reported regularly, until the question of operating high tension underground conductors is solved or effectually disposed of, and to do this we recommend that the committee be made permanent, and that members be elected annually at the February Convention.

The committee should report at each convention: The number of companies operating high tension underground conductors; the mileage of conduits, ducts and conductors in use; the cost per mile per month of conduit maintenance and repairs; the average number of burn-outs and grounds per mile of conductors used, and the causes. Also report all conduits, conductors, etc., that had proved failures and were abandoned.

In this manner the association would keep thoroughly posted regarding the progress of the subject and would be supplied with the actual records made by the different systems; the members of the association could then judge for themselves of the success of the different systems and thus be able to act intelligently, in case they desired to do any work in this line.

As this plan is intended to extend beyond the time for which this committee was selected, we have recommended that same be adopted by the association and that provision be made for the annual appointing of members to the committee.

If this meets the approval of the convention we would appreciate any suggestion from members who are especially interested in this subject looking to the perfecting of the plan of work.

I would say in addition to that that I think Mr. Lockwood has omitted one point, in regard to the cost of the conduit that is down. That cuts a very important figure in the estimate of what it really means to operate underground conductors, and the committee I think ought to have the privilege of adding any such questions to their catechism which they will submit to these other companies using underground work, which they think may be necessary.

On motion of Mr. De Camp the report was received and the committee continued.

The report of the Committee on the Relations between Manufacturing and Central Station Companies was read by Judge Armstrong.

The Nominating Committee reported to continue the existing Executive Committee for another year, with the exception of one member, Mr. Thurber, who requested that some one else be asked to serve in his place—Mr. A. J. DeCamp being selected to fill the vacancy.

Providence, L. I., was selected as the place in which to hold the next meeting, the time of the holding of which will be announced later by the Executive Committee.

On motion, the convention adjourned *sine die*.

**Caught at Cape May.**

Mr. F. E. Pettingill, energetic and popular as usual, accompanied by his charming wife, attended the convention in the interests of his company—Pettingill-Andrews Co., of Boston.

The exhibit of the Empire City Electric company, of New York, in Parlor C, was composed of a number of cards of samples and a number of coils of wire. President Gen. O. E. Madden and C. J. Hayne represented the company.

C. L. Tolles, on behalf of the Jewell Belting Co., of Hartford, exhibited a number of specimens of its belting.

F. P. Wisner represented the Consolidated Fruit Jar Co. of New Brunswick, N. J., which company is making quite a specialty of fuse wire, together with a number of metallic parts needed in general electrical work.

Messrs. Wm Bracken and Pedro G. Salom represented the Consolidated Electric Storage Co., of N. Y., which displayed twelve accumulators charged at its factory, and which furnished current for the only electric lights displayed at the convention. A C. & C. fan motor was also operated by this battery.

The National Carbon Co., of Cleveland, O., distributed copies of its "Directory of Electric Arc Lighting Plants," a publication of over one hundred pages, and brought down to date of Aug. 1, 1890. The company was represented by Messrs. Smith, Couré and Miles.

Col. Louis W. Burnham, General Manager of the Electric Gas Lighting Co., of Boston, represented that company at the convention.

President Ralph Shainwald and Mr. W. W. Castle, of the P. & B. Construction Co. and the Standard Paint Co., exhibited insulating compounds, P. & B. paints, armature varnishes, etc.

The always affable and ubiquitous Harry E. Keller, whose headquarters are at Allentown, Pa., from which point he looks after the interests of the travelling passenger department of the

C. B. & Q. R. R., went down to the convention on the Monday, on the 1.30 express, to renew acquaintance with a large number of the delegates whom he met on the memorable "Electric Limited" from New York to Kansas City last February. Mr. Keller is a universal favorite and commands friendship wherever he goes.

Circulars and illustrations of the celebrated Baragwanath Heater were distributed by the manufacturers, Wm. Baragwanath & Son, of Chicago.

W. H. Shoemaker represented the interests of the Moore & White Co., of Philadelphia, Pa., and exhibited a model of a friction clutch pulley.

The Crocker-Wheeler Co., of New York, exhibited a number of its beautiful motors, the business part of the convention at Cape May being attended to by Messrs. Crocker and Wheeler, while the social side of the convention suffered not at the hands of the appreciative Mr. T. McCoubray, who, we hear, will shortly visit Lenox.

A superb exhibit was that of the Interior Conduit and Insulation Co., of New York City, which company was well represented by its president, Mr. E. H. Johnson, his first lieutenant Mr. E. W. Little, and Mr. E. T. Greenfield, electrician. The exhibit consisted of a magnificent display of conduit tubing mounted on a superbly handsome sample board, together with other apparatus for interior wiring. It attracted a great deal of attention, and all callers were presented with a very neatly gotten up little pamphlet containing facsimile letters of recommendation from Elihu Thomson, Thos. A. Edison, and others.

The Eureka Tempered Copper Co., of North East, Pa., had quite an extensive and interesting exhibit of journal bearings, segments, brushes, finished and unfinished commutators, etc., of pure copper, for which the claim is made that it possesses a tensile strength of 64,480 lbs. to the square inch, with upwards of 110,000 lbs. as the load of compression. Mr. A. L. Daniels represented the company in the stead of Mr. Nathan Bushnell, its New York agent, but who was detained by the demise of his brother, Ives Bushnell, by drowning, about two weeks ago, near New Haven, Conn.

New Britain, Conn., was represented, in one of its industries at least, by Captain T. H. Brady, the inventor of the Brady mast arm. Captain Brady received very many hearty congratulations upon his recovery from his recent illness.

Mr. H. M. Smith attended to the interests of the Washburn & Moen Co., of Worcester, Mass., and had on hand an exceedingly appropriate and interesting exhibit, which embraced one small coil of what is known as 38-wire, which coil contained no less than eight miles of wire in one continuous section. The exhibit was well timed and certainly in charge of the right man.

"Clark" wire was most ably boomed by Mr. H. H. Eustis.

Messrs. A. D. Newton and M. E. Baird attended to business for the Eddy Motor Co., of Windsor, Conn., whose motor is too well known to need any description at our hands.

The Connecticut Motor Co., of Plantsville, Conn., which makes one of the best and most perfectly finished motors in the United States, was well represented by its secretary, Mr. J. R. Stagg, who exhibited a half-horse power constant potential motor of particularly handsome design. This motor has already been very fully described in the GAZETTE, so further description at the present time is unnecessary. The motor attracted no little attention. The highest possible efficiency is claimed for the machine, for which there is a great demand.

E. P. Atkinson, representing Chas. A. Schieren & Co., the well known belt manufacturers of New York, distributed a number of particularly pretty circulars descriptive of the company's belting, etc.

Messrs. F. E. Degenhart of Chicago, J. W. Marsh of Pittsburgh, and Geo. L. Wiley of New York, three of the best fellows ever attending a convention, looked after business for their company, the Standard Underground Cable Co., of Pittsburgh, Pa.

Mr. Sam Rosenstamm very ably represented the interests of the well known firm of Lewissohn Bros., of Fulton Street, New York City, dealers in bare copper wire and copper goods in general.



Day's "Kerite" was as usual cared for by the young and popular Geo. B. Prescott, Jr.

H. A. Cleverly, of Philadelphia, looked after business for his concern, the Cleverly Electrical works.

The Nubian Iron Enamel Co., of Chicago, distributed circulars of its enamel for arc lamps. "Simplex" wire was well represented by General Manager Dr. A. F. Mason, W. H. Gordon and Geo. Cutter.

H. L. Lufkin and A. M. Hall looked after the C. & C. Motor company's business, and the former prepared an intensely interesting paper for the convention, a report of which appears in present issue.

Schultz belting suffered nothing at the hands of A. B. Lawrence, who booked an order for 4,500 feet of belting during the convention. There were many inquiries for Mr. J. A. J. Schultz, likewise sincere regrets at his absence.

Mr. Geo. Cutter kept up his record as a worker and made business hum for the Great Western Electric Supply company of Chicago.

A cheap hard rubber tube, of new design, for insulating purposes, was exhibited by Mr. G. B. Meeker on behalf of the Metropolitan Rubber company of New York City.

Bro. Jean A. Wetmore and Mr. L. D. Beck, representing the Norwich Insulated Wire Co., showed a number of underground arc light cables, made especially for high voltages, a test of nearly 10,000 volts having recently failed to show any detrimental effects.

J. P. McQuade, of New York, looked after the interests of the National Conduit Manufacturing Co.

An interesting exhibit was that made by J. W. Queen & Co., who showed a number of galvanometers, ammeters, amperemeters, resistance boxes, etc. E. G. Willyoung was in charge of the exhibit.

The Field Engineering company was represented both among the supply men and on the floor of the convention by Mr. C. J. Field, one of the most able and best known young electricians in the United States.

Mr. Wilfrid Fleming, manager of the advertising department of the Edison General company, Mr. J. F. Kelly and H. Ward Leonard attended to the interests of the Edison combination. Mr. Fleming is one of those rare geniuses who can sit down in an office and conduct a technical paper in all its details, then start right off and complete an installation of a thousand lights or more, and "never mind it a bit."

Messrs. W. A. Stadelman and Wm. Hazleton 3d were in attendance at the convention in the interests of their concern, the Equitable Electric Construction Co., of Philadelphia, agent for the Wenstrom Consolidated Dynamo and Motor company, of Baltimore, Md. Mr. Stadelman was accompanied by his charming wife, who, by the way, is regarded by her husband's firm as a mascot, all the electric street car lines which she started into operation having proved to be brilliant successes.

The Elektron Manufacturing Co., of Brooklyn, N. Y. exhibited a Perret motor superbly finished and handsomely designed.

Mr. Frank A. Magee made things "hum" for the E. S. Greeley Co.

Messrs. G. H. Fisher and E. P. Atkinson represented the well known firm of Chas. A. Schieren & Co., of New York, manufacturers of one of the best dynamo belts in the world for electric railway service.

Mr. D. M. Steward represented the D. M. Steward company, of Chattanooga, Tenn.

J. J. Ryan & Co., of Chicago, circulated a neat little pamphlet of their new brass foundry.

Mr. Waldo P. Adams looked after business for his company, the Western Power Construction Co., of Chicago.

Mr. C. I. Hague boomed matters for "Helmet" wire, on behalf of the New Haven Electric Wire Co., of New Haven, Conn.

Mr. C. S. Van Nuis, of New York, attended the convention in the interests of the Ajax Switch.

Mr. Fred. W. Royce, of Royce & Mareau, Washington, D. C., attended the convention in the interests of his company.

The Globe Carbon Co., of Cleveland, O., was well looked after by Mr. Rodman.

Pass & Seymour, of Syracuse, N. Y., had Mr. Seymour in attendance on their behalf.

E. W. Wilkins represented Partrick & Carter, of Philadelphia, Pa.

C. D. Warner, President of the Standard Electric Line Company, of New Haven, Conn., exhibited some electric gauges for testing batteries, arc light circuits, etc.

The Abendroth & Root Manufacturing Co., of 28 Cliff Street, New York, had some pamphlets distributed descriptive of the Root safety boiler.

Mr. J. H. Van Gestel fully explained the working of a new dry battery of which he is the inventor, and which is controlled by the Crosby Electric company.

Mr. Norman Marshall, President and Manager of the Star Electric company, of Philadelphia, exhibited some specimens of insulating attachments for fixing incandescent lamps to gas fixtures, single and double pole switches, etc.

An interesting exhibit was that of the Jordan Train Lighting Co.'s electric light coupling for cars. The company also exhibited a new form of trolley line suspender, which dispenses with the soldering process.

Messrs. K. E. Gallaher, C. A. Place, G. H. Meeker and the ever popular J. W. Godfrey exhibited a full line of Grimshaw tape, wire, etc., on behalf of their concern, the New York Insulated Wire company.

John A. Seely, President of the Seely & Taylor Manufacturing Co., of New York, showed samples of the "S. & T." compound, and Seely's "flexible wired molding" for interior wiring.

The Indurated Fibre Co., of 40 Wall street, New York, showed some indurated fibre pipe for underground conduits. Mr. G. S. Bowen looked after the exhibit.

Of course Bro. Fred. E. Degenhart, of Chicago, was on deck in the interests of the Standard Underground Cable Co., of Pittsburgh, Pa. He was accompanied by Mr. J. W. Marsh, of Pittsburgh, and Mr. Geo. L. Wiley, of New York. The trio formed a hard team to equal and one well nigh impossible to beat.

P. C. Ackerman, of the American Electrical works at Providence, R. I., attended the convention, and showed a full line of wire and cables.

Mr. H. H. Eustis represented the Eastern Electric Cable Co., of Boston, of which he is president.

H. T. Paiste, of Philadelphia, exhibited a number of electrical specialties. He was represented by Mr. Wm. R. Hood.

H. E. Duncan, of the American Waltham Watch Co., was present. He made no exhibit—but hosts of friends.

A new insulating material that attracted considerable attention was "Alexite," which was part of the exhibit of the Sawyer-Mann Electric Co., in charge of P. H. Alexander and Gen. C. H. Barnes, of New York. The display included some new branch cut-outs made in porcelain, rosettes, detachable plugs, etc. The exhibit was both brilliant and complete, and the convention headquarters of the Sawyer-Mann Co. were some of the most attractive at the Cape.

The Sperry Electric Co., through Mr. Charles E. Gregory, exhibited a new triple carbon arc lamp mounted on an electric light pole in front of the Stockton—a unique and clever idea, by the way.

W. H. Shoemaker represented the Main Belting Co., of Philadelphia, and exhibited samples of its celebrated Leviathan belting.

The Chalmers-Spence company had a new catalogue descriptive of its asbestos goods distributed.

Messrs. J. M. Orford and W. C. Bryant, of the Bryant Electric Co., of Bridgeport, Conn., exhibited the Bryant double-pole switch, the Orford pendant, etc., etc.

"Cunninghamite," another new insulating material, was exhibited by its inventor, Wm. E. Cunningham, of Philadelphia, Pa.

Messrs. Newton, Baird and McIntire represented the celebrated Eddy motor.

Geo. A. McKinlock attended the convention in the interest of the Central Electric Co., Chicago.

Mr. L. W. Serrell, Jr., represented the Milliken pole for electric railway works.

A lot of printed matter was distributed by the Walsh Gasoline Torch company.

Mr. O. S. Platt, of Bridgeport, Conn., was in attendance, and exhibited his "New England" switch to a large number of interested delegates and others.

Mr. Theo. Larbig represented the interests of Holmes, Booth & Haydens, of New York.

W. B. Cleveland, of the Forest City Electric works, Geneva, O., exhibited a new lamp hanger.

Mr. C. C. Curtis attended the convention in the interests of the Brush Electric Co.

Mr. C. R. Vincent, of the well known engineering firm of Charles R. Vincent & Co., was on hand and talked up "Ball" engine with his large number of friends and acquaintances.

Vice-President Groetzinger, General Manager Col. J. H. Shay, his brother J. W. Shay and Mr. Gabel looked after matters for the Munson Belting Co. of Chicago.

Col. Shay left for the West, via Washington and Pittsburgh, shortly after the convention adjourned.

Mr. Alfred F. Moore, of Philadelphia, was there looking up matters in the wire way for his well known firm.

Mr. H. S. Winston represented the Illinois Electric Material Co., of Chicago, but was compelled to leave before adjournment.

Mr. James Powell, of the Wm. Powell Co., of Cincinnati, O., exhibited a number of lubricating devices, oil cups, etc., conspicuous among which was the Powell patent improved spiral oiler, in which the flow of oil can be stopped at once, at any time, without changing the feed.

Messrs. W. L. Shippey, F. A. C. Perrine and W. E. Frick attended to business for John A. Roebling's Sons, of Trenton, N. J.

Mr. H. J. Conant, representing the Evans Friction Cone Co., of Boston, distributed a number of catalogues and blue prints showing system of driving dynamos by the Evans friction pulleys.

W. H. McDonald represented Little, McDonald & Co., of Buffalo, N. Y.

"Mind-reader" Slattery, Messrs. Morrison and Wilbur cared for the interests of the Fort Wayne (Ind.) Electric Co.

The Sensible Automatic Packing Co., of Chicago, distributed a very pretty circular on its flax packing with pure Para rubber core and wax lubricant.

Messrs. H. H. Small, of Chicago, represented the Thomson-Houston Co., in company with W. F. Davidson, of Michigan.

The Western Electric Co., of Chicago, was represented by Mr. Chas. A. Brown.

A new form of mineral wool insulation was that of which samples were distributed by the Chicago Fire Proofing Co.

Mr. W. F. Cullen represented the E. P. Gleason Manufacturing Co.

The Pumpelly Storage Battery Co., of Chicago, distributed circulars regarding its storage battery.

Mr. Almy, of Philadelphia, one of the most genial fellows upon earth, was on deck in the interests of the United Electric Equipment Co., and was the one who arranged for the celebrated test of the fire alarm system exhibited there. The company represented by Mr. Almy is the agent for Chadbourne, Hazleton & Co., and it exhibited a Wenstrom motor, some street car gearing (recently illustrated in the GAZETTE), and a model of an electrically actuated elevator.

WE have received an illustrated catalogue of The Connecticut Motor Company, of Plantsville, Conn., showing the style of electric motors, power generators and incandescent dynamos manufactured by them. Their machines are of the simple short horseshoe magnet type, having the poles placed upward as a means of preventing the leakage of magnetic lines of force through the bed plate, as is claimed to be the case with machines having the magnets inverted. The catalogue gives a full description of the machines as well as considerable useful information in regard to the application and distribution of electricity for power purposes, as well as mentioning many points they employ to obtain an economical electrical machine built in strict accord with the best mechanical principles.



# ANNUAL MEETING OF THE Street Railway Association.

OF THE STATE OF NEW YORK.

The eighth annual meeting of the Street Railway Association of the State of New York was held at the Powers Hotel, Rochester, N. Y., Tuesday, September 16th, 1890.

President John N. Partridge, of Brooklyn, presided, and Secretary Wm. J. Richardson was in his place.

The delegates present were as follows:

Albany, N. Y.—Samuel Cowdrey, Pres. Watervliet T. & R. R. Co., Albany; John W. McNamara, Pres. Albany Railway.

Brooklyn, N. Y.—Wm. Richardson, Pres., and Wm. J. Richardson, Sec. Atlantic Avenue R.R. Co., Daniel F. Lewis, Pres., and E. W. Bliss, Director Brooklyn City R.R. Co., John N. Partridge, Pres. Brooklyn City & Newtown R.R. Co.

Buffalo, N. Y.—Henry M. Watson, Pres. Buffalo Street R.R. Co., Porter Norton, Director East Side Railway Co.

New York City—C. Densmore Wyman, Vice Pres. Central Park, N. & E. River R.R. Co., George Green, Pres., and Charles P. Emmons, Sec., Forty-second Street & G. Street Ferry R.R. Co., Daniel B. Hasbrouck, Sec. Houston, West Street & P. F. R.R. Co.

Pelham, N. Y.—W. R. Lambertson, Pres., and Sherman T. Pell, Director Pelham Park R.R. Co.

Rochester N. Y.—Arthur G. Yates, Pres., John B. Beckley, Sec., Arthur Lutchford, Treas., and Norman McD. Crawford, Ass't Man., Rochester Railway Co.

Troy, N. Y.—Charles Clemishaw, Pres., and Charles H. Smith, Supt., Troy & Lansingburg R.R. Co.

There were also present: J. H. McGraw, C. B. Fairchild and E. H. Chapin, *Street Railway Journal*; E. V. Cavell, *STREET RAILWAY GAZETTE*; Edward Caldwell *Electrical World*; F. L. Blanchard, *Electric Power*; J. L. Taitavall *Electric Age*; E. E. Higgins and F. R. Chinnock, Edison General Electric Company; Norman McCarty, Thomson-Houston Company, and Frank A. Rogers, Short Electric Railway Company.

The Treasurer's report was read and showed:

Receipts during the year .....	\$1,104 06
Expenses during the year .....	781 43
Balance.....	\$322 63

The President of the Association then delivered his address, as follows:

*Gentlemen of the Street Railroad Association of the State of New York*—We are assembled here to-day from all parts of this State for the interchange of thoughts and ideas gathered from our daily experiences as street railroad men, and to consider new theories and inventions applicable to our business. Let us take hold of the work before us so energetically and pursue it so faithfully that we may return to our homes at the close of our session enlightened, refreshed and better fitted for our work.

So far as I can learn, the companies here represented have had a successful business year and are to be congratulated upon it. Certainly, many of the conditions which bring prosperity have prevailed. Prices for provender and supplies have been low; we have been comparatively free from labor strikes and agitation, and our employes, in the main, have been contented; our last winter was mild and brought us but little snow and ice, and business generally throughout the State has been prosperous.

The Legislature at its last session treated us kindly. A disposition to deal fairly with all measures affecting street railroads was manifested both in the Senate and Assembly. Your attention is especially called to the revision of the corporation laws as affected in chapters 563, 564, 565 and 566, passed during the last session and approved by the Governor June 7th. By their enactment many existing laws are repealed and others have been to some extent amended.

These acts do not take effect until May 1st, 1891. The reason for fixing this date so far in the future was, I understand, to allow of their careful examination and consideration, and if it should be found to be desirable, of their further amendment by the next Legislature.

In the meantime the members of this association will do well to examine these acts carefully, more especially chapter 565, article 1, relating to surface railroads.

Marked progress has been made since our last meeting in the substitution of mechanical and electrical devices for the propulsion of street cars in the place of horses. In New York City the Third Avenue company is about to extend its cable system down town, through the busiest thoroughfares, to the City Hall, this extension having been made possible by a recent decision of the Court of Appeals.

In many of our cities and towns where the electric car was unknown a year ago, it is to-day a familiar sight. Its coming has been opposed by a few alarmists, who predicted that it would bring with it death and destruction. Similar predictions were made of the locomotive and even of the horse cars in their early days. But public convenience was served by both and their use has been marvelously extended. Wherever the electric car has been introduced it seems to have met with general favor.

Its noiselessness, its cleanliness, and its capacity for obtaining a high speed wherever a high speed is safe, commend it to the riding public as a welcome substitute for the horse car, with the clatter of the hoofs and the slow jog of the horses and their offensive droppings.

Some of the brightest minds in this and other countries are actively working to develop improvements in the various systems known as the "conduit," the "storage battery" and the "overhead wire." Who will dare to say what they will accomplish, in view of the great progress made during the last decade in the telephone and in electric lighting.

What we, as street railroad men, want is a system which is simple and economical in its construction, in its adaptation to our existing equipment, and in its operation.

The introduction of the electric car, with its greater weight, creates a demand for a heavier rail and a more substantially constructed road. Inventors are looking after our needs in this direction and new patterns of rails and new methods of laying them are constantly brought to our notice.

These and kindred subjects will be more fully and ably treated in the reports of special committees and in the discussions which will follow. To these, and to the regular business of the convention, I now ask your attention.

The report of the Executive Committee was presented.

ROCHESTER, N. Y., Sept. 16, 1890.

TO THE STREET RAILWAY ASSOCIATION OF THE STATE OF NEW YORK:

*Gentlemen*—Your Executive Committee would respectfully present the following report:

### Membership.

We have to note the withdrawal of the Fifth Ward Railroad company, of Syracuse, it being considered by the new management to be too small a corporation to be connected with an association whose individual membership is so formidable. There are now twenty-three companies members.

### Electricity.

As the subject of the propulsion of street cars by electricity has become so prominent a question in the consideration of municipal authorities, as well as on the part of street railway managers, your Committee deemed it advisable to give unusual prominence at this meeting to the subject of electricity as a motive power. To this end a report on the subject of "An Electric Street Railway Motor," prepared by the president of a company that is using a system of electric power, will be followed by the presentation of facts concerning electrical propulsion by the representatives of the several overhead systems, all of whom have been invited to attend the meeting for this purpose. It is confidently believed that the facts elicited will materially aid companies that for some time past have had the subject under consideration, in bringing about the desired change.

### The Labor Question.

We take pleasure in noting a new departure in this State, an evident essential feature of which is the establishment of permanent friendly relations between the management of the company and the employes. We refer to the organization during the year of mutual benefit societies amongst their employes by the Third Avenue Railroad company, of New York, and the Atlantic Avenue Railroad company, of Brooklyn. The practical working of these societies, although neither of them is a year old, is the best evidence of their usefulness, both to the men and the company. Their members are readily, easily and surely provided for against entire loss in case of illness or accident, sure to come sooner or later; an extensive provision is made in case of the death of the member and in his family, while the assistance rendered to and interest taken in the societies by the companies is shown to be heartily appreciated by a manifest improvement in the service rendered by the employes. We heartily commend to the members of this Association the careful study of the workings of these societies and the results accomplished by them.

### Legislation.

As to the subject of legislation, perhaps "the least said is the soonest mended." We desire, however, to take this opportunity to congratulate the State, and especially the city of New York, upon the action of the wise Governor of this great State in vetoing the iniquitous Cable Bill. This hydra-headed monster, which, like the ghost of Banquo, would not "down" at the bidding of either press or public, but annually stalked forth to affright the community, has, we trust been given its quietus.

### Obituary.

It is with deep regret that we are called upon to record the death of Heman B. Wilson, one of the oldest men in the street railway business, and at the time of his death the superintendent of the Eighth Avenue Railroad company. He had been connected with this company for thirty-five years. Mr. Wilson was the embodiment of faithfulness, integrity and kindness. Everybody with whom he came in contact was drawn to him by his genial nature. In his death the company he had so faithfully served lost an estimable manager and his associates a valued counsellor and friend.

Respectfully submitted.

JOHN N. PARTRIDGE,  
WM. J. RICHARDSON,  
DANIEL F. LEWIS,  
C. DENSMORE WYMAN,  
GEORGE GREEN,  
Committee.

The report was received and filed.

John W. McNamara, president of the Albany Street Railway, read the paper of the day on "An Electric Street Railway Motor." The paper is given complete as follows:

Soon after the road-bed of the Albany railway was completed, and during the summer of 1864, when the directors and projectors of that road often saw four horses vainly endeavoring to draw the passengers contained in a twelve-foot car up a grade of eight per cent. on State street, their attention was very naturally turned to the solution of the problem of transmitting the power of steam to the car.

Device after device was tried, but all proved failures, but still the directors never lost hope that at some time the problem would be solved. The successful use of the cable in San Francisco stimulated the stockholders to an effort to secure capital enough, to construct a cable road; but the large amount of capital necessary to lay a cable road, and the want of faith in its working in this climate during the winter months proved formidable obstacles.

More than twenty years had passed since the road was opened, and horses were still being used to draw the cars, when the attention of the managers of the road was called to certain experiments made by Mr. Leo Daft, who had for many years been a resident of two adjacent counties. Those of the managers who saw what the Daft Electric Motor did, felt that the day of emancipation for the State street car horses was rapidly drawing nigh. The experimental roads which are familiar to us all, were earnestly examined, and the time when the obstacles to smooth operation would be overcome hopefully expected.

The time came much sooner than the most sanguine of us dreamed of; Baltimore, Scranton, Meriden, Richmond, Hartford and Boston followed in rapid succession, Scranton and Meriden demonstrating that it was possible to operate electric motors in winter. Our sister city, Troy, joined the electric band, and our sister company, The Watervliet Turpike and Railroad company, also contracted for electric equipment, before the Albany Railway could determine which of five systems was the best and make a contract. It was finally made with the Thomson-Houston Electric company on the 30th day of November, 1889, and cars began running on the State street line April 28, 1890, and on May 1st all the horses on that line were withdrawn.

None of our drivers had had any training until the evening of April 27, 1890, yet we were able to begin running schedule trips with three cars the next day. Over four months' experience has taught us that the electric motor is efficient and reliable. We have yet to learn, by experience, that it will ascend State street, an eight per cent. grade, at the rate of five miles per hour in winter, as it has during the summer. We have also to learn, by experience, for it seems to be impossible to learn it in any other way, whether operating cars by electricity is more economical than by horses.

At the time of the introduction of the electric motor, the ordinary street car drawn by horses was the most convenient vehicle in public use. It was easy to enter one, and easy to alight from one. The various makers had vied with each other until one was able to step as easily from the street into a car, as he could ascend two steps of his own stairs. The early builders of electric cars endeavored to retain this feature of the street car, and placed the motor proper on the car communicating motion to the axles by means of sprocket chains and wheels; but the mechanical difficulties, and the noise made by the chains and wheels, led to their abandonment, and the motor, or motors, were then placed on the axles and under the car, where we find them to-day.

At first the easy-of-access feature was retained, but as the necessity for larger motors and more room for them became apparent, the car body was gradually raised until it is too high for children and elderly people to enter readily, and a great deal of time is consequently used in receiving and discharging passengers.

The car body has been raised at the expense of comfort without, it seems to me, improving the condition of the motor. It is still under the car near mud, dust, snow and slush, and is as difficult to get at as it ever was.

With these exceptions the electric motor of to-day is well nigh perfect, but these exceptions, as time goes on, will become more serious. When the novelty of being regularly and rapidly carried to their homes and places of business ceases, then passengers will call attention to the difficulty of entering and leaving cars.

The size of the motor, especially for use on grades, should not exceed the standard—sixteen feet for box cars, and about twenty five feet for open cars. On level and suburban roads, where the headway is not less than twenty minutes, larger cars with eight wheels might probably be economically used; but for populous cities where headway is less than five minutes, the old standard car body is, in my opinion, the best.

How the motor is to be arranged with reference to the car body so as to admit of easy access to it for examination and repair, may, or rather must, be left to mechanical and electrical engineers. That we will continue to drag them in the dust and mud very long I cannot believe.

I think the opinion of all who are unprejudiced, is that the overhead single trolley under contact systems, are the most reliable and efficient. With good overhead construction the loss of power in transmission is but slight, and the conductors are always where they can be seen and kept in place.

The ideal motor is one which is independent of every other motor, or other engine, and contains everything necessary to make it go. This motor exists, and seems to work fairly well on grades of not more than five per cent.; but that it is capable of doing the work now being



done by motors of overhead system, is still problematical. However, as we have already witnessed such wonders in propelling cars by electricity, may we not hope for a storage battery electric car, which shall be equal to any now in use?

We are justified, I think, in recommending to all who think of changing from horse to electric motors, or to all who think of building new roads, the overhead single trolley system. All the manufacturers of motors and generators have their systems in use in cities, which can be readily visited, and the merits of all can be compared.

The question as to whether the electric motor is as economical as the horse car, cannot yet be answered, and need not be answered. Just as certainly as the horse car supplanted the omnibus, the electric motor will supplant the horse car. The horse car, however economical, must go, and the electric motor, no matter how expensive, must come.

The report was ordered to be placed on file and spread upon the minutes. Mr. Frank A. Rogers, representing the Short Electric Railway company, of Cleveland, opened the discussion as follows:

Mr. Chairman and Gentlemen: I desire to say a few words in behalf of our system, and to call the attention of the gentlemen to some of the principal points of our motors, in the armatures especially. We use an armature that is large in diameter and which is run at a slow rate speed. When the car is running at the rate of twelve miles an hour, the armature revolves at about one thousand revolutions per minute. We use very large pinions,  $6\frac{1}{2}$  in. pinion, which is made of the best machine steel; the large gears are made of cast steel, and have wooden webs between the rim and the hub, which are put there for the purpose of deadening the noise, and also to serve as an insulation—insulating the motor itself from the ground; the ground connection being made directly from the motor to the car axle by flexible cable connections. The axle part of the motor is insulated by heavy wooden beams, connecting the motor itself with the axle portion. We do that in order to deaden the noise and to get perfect insulation from the ground to the armature. The "series" system has been practically abandoned by our company; we are now using what is known as the parallel system, similar to that of the Thomson-Houston and Sprague; that is, in connection with the distribution of current and the style of overhead construction. The Short motor differs greatly in mechanical construction and electrically from any other. The field magnets, which are four in number, are "series" wound in one coil on each magnet, and the coils on the armature are entirely separate from each other. If one of the coils should happen to burn out it does not touch any other coil on the armature, and is very easily repaired on account of there being very little of it. We have a great deal of apparatus here in Rochester at present. It is mostly in boxes in storehouses. The company has been hindered somewhat in getting their construction under way—their poles set up—and this has caused some delay in starting our cars in operation here.

Mr. LEWIS, of Brooklyn: What is the reason of your abandonment of the "series" system or principle?

Mr. ROGERS: It was not a success with a large number of cars.

Mr. LEWIS: Why was it not a success?

Mr. ROGERS: The trouble came in the generators. It is a success with two or three cars, but with from five to a hundred cars it is not so successful. We think the parallel system is better.

Mr. LEWIS: I understand the series system to be composed of a main conductor carrying the current of electricity, and being shut off in sections. That you say is not successful. How does it act generally?

Mr. ROGERS: Not well with a large number of cars.

Mr. LEWIS: You say it acts unfavorably on the generator. I understand that the abandonment of the system is because it acts unfavorably on the generator. Is that due to any great complication through this series system?

Mr. ROGERS: The trouble is that it is a hard matter to manufacture what we call a constant current generator. It is almost impossible to manufacture a generator that could be operated with little attention. The motors work fairly well on small roads. They are in successful operation at Huntington, Va., and Columbus, Ohio, but you understand that for a large num-

ber of cars it is not so well adapted as the parallel system.

Mr. LEWIS: My idea was to bring before the meeting the reason for the abandonment of the series system, and the preference of the parallel system. The parallel system seems to have been generally adopted. The generator, you say, throws a constant current from it into the conductor. You cut off the current by the series system, and put it on by some action. Does that make an uncertain return, so that it throws the generator out of gear?

Mr. ROGERS: It fluctuates, so that the generator does not take care of the current. In the parallel system the electro-motor force is constant. In the series system the current is not constant, and in that way it is not adapted for a large number of cars. And then the construction, the overhead work, is more complicated; a switch being used in it, and the cars could not be bunched, that is, a number of cars in the same section. Professor Short has been through that very carefully, and has spent a great deal of money in trying to work the system up and make it a success, and has also experimented largely in underground work before the new company was organized, but since the organization of the new company the parallel system has been adopted.

Mr. LEWIS: Mr. McNamara's report suggested the single wire under contact system. Do you prefer that to the double return?

Mr. ROGERS: Yes, sir, single overhead wire and rail return.

Mr. LEWIS: What is the reason?

Mr. ROGERS: It is not so complicated, and in a large city where there is one line crossing a number of tracks, it lessens the number of wires overhead. At Cincinnati we were obliged to put in the parallel double overhead wire, on account of the telephones there, and the street-railway managers, being largely interested in the telephone companies.

Mr. RICHARDSON, of Brooklyn: Why?

Mr. ROGERS: To overcome induction in telephones. At the time we did not care to put it in, but they desired it, and seemed to be entirely satisfied with it, and we took the contract to put it up. There is only one other company in Cincinnati, the Thomson-Houston, using the double overhead system. The Sprague, I believe, is using single overhead.

Mr. LEWIS: I understand the objection by the telephone companies to be that you do not get a full return of the waste current through the means you employ for that purpose. It goes through the earth, and is attracted by their systems, and gives a buzzing sound to the telephones.

Mr. ROGERS: That is not in all cases; it depends on the distance their ground return is from the street-car circuit.

Mr. CLEMINSHAW, of Troy: Will you not give us an idea of your line construction as differing from the Sprague, or Thomson-Houston?

Mr. ROGERS: In the parallel system we use practically the same plan and principle as in the other systems that are parallel. What is meant by "parallel" is that the cars are in a circuit, so that the current equally divides through each car as the amount of current is required to drive it. In the "series" system the same amount of current all passes through each car. It does not equally divide. For instance, a quantity, say, what we call 40 amperes, all goes through each car, where in the parallel system it divides equally through each car. If you have a generator that is producing 160 amperes, and you have five cars on the track, each one of the cars takes its proportion of current, and it may not be all of the output of the generator. It depends, of course, on the road, grades and load being carried.

Mr. CLEMINSHAW: Give us some idea of your line construction as you propose to put it up here in Rochester.

Mr. ROGERS: As I said before, it is parallel, and we use feeders in our construction work. We do not use or employ solder where there is a strain on the line. The connections are all mechanical. We have a patent device for making connections of the trolley wire splices without using solder.

Mr. CLEMINSHAW: I understood you last

evening to say that you insulated your trolley wire at points on the line. The Thomson-Houston has no such system as that. Will you please explain that feature of your system which is different from other systems?

Mr. ROGERS: The idea is that we can "feed in" from one feed wire running the length of the line, divided in sections, each section being insulated from the other; that is, the trolley wire. Of course, that depends on the length of the road and number of cars to be operated. This wiring has all to be figured for carrying capacity and equal distribution over the line, and what one road would require, another road would not in that respect. On some lines we do not use any feed wire at all.

Mr. LEWIS: I think you just said that you feed in from your feed wire into a sectional trolley wire?

Mr. ROGERS: Yes, sir; where we use only one feed wire, that is also parallel, so that while a car is going through a section, it is merely using current in that section, and after the car has passed that section, there is no current running through. The other plan is to use a number of feed wires, running along and feeding in, without the trolley wire or trunk line being in sections.

Mr. CLEMINSHAW: I understand your trolley wire is really a trunk wire?

Mr. ROGERS: In that case it is.

Mr. RICHARDSON: I ask whether in your judgment, Mr. Rogers, what you have said in regard to five cars in operation on a road is just as applicable to a system of fifty cars running three minutes apart over a road from four to five miles?

Mr. ROGERS: Yes, sir. You understand that all the variation in the wiring for different places must be figured out for the several carrying capacities of the roads, and for equal distribution over the lines. There are hardly three cities out of five that have the same wiring and the same size, and feed in at the same places.

Mr. RICHARDSON: What is the minimum and maximum size of the wires used?

Mr. ROGERS: Any wire from 00 up to 5.

Mr. McNAMARA, of Albany: If you can give the diameter in inches it would be better.

Mr. ROGERS: I should think the number 00 was  $\frac{3}{8}$  in., perhaps, number 5 would be about  $\frac{1}{8}$  in. or in that neighborhood; perhaps a little more, three-sixteenths in.

Mr. E. E. Higgins, of the Edison company, spoke as follows:

The Sprague company is now a part of the Edison General Electric company. There is one point I want to mention first, and that is that at three o'clock on the 4th day of September, 1882, the old Pearl Street station of the Edison company started out. On January 2d, 1890, it burned out from an accidental spark. Between those two dates that station turned out current twenty-four hours in each day without stoppage. I mention this for several reasons. In the first place, it ought to do away with some of the objections that have sometimes been raised to electrical systems on the part of the public on the ground that it is not reliable. The generation of electricity is reliable. When the first station of the kind ever built can run for nearly eight years, as that station did, it is true that the stations that are now built can do even better work. The old Pearl Street station settled this fact, that you can take coal, turn it into steam, turn it from steam into electricity, and transmit the electricity through an enormously expensive underground system of conductors, and can turn it again from electricity into light at a price which will compete with gas made from coal. That is an example of the advantage of steam and electricity over steam even which has made the electric railway what it is to-day. It costs to run a car by electricity for the "providence" (coal and water) about seventy-five cents, and to feed eleven horses for the same service, same number of hours per day, it costs a little over two dollars a day. You can see, again, that there is an enormous intrinsic advantage of steam and electricity over horse. The Edison company proceeded with the electric light business, and, about 1885 or 1886, Mr. Sprague, who was then with the Edison company, came out with his electric railway system. The principal things brought out by Mr. Sprague, and copied ever since, were the placing of the motors underneath the cars and attaching them to the axles on one side and to a spring support on the other, and this spring support was the one feature which enabled the Sprague company to use spur gearing. Previous to that time sprocket-wheels and chains and worm gearing had been used. Spur gearing had been used and discarded for the reason that the lack of flexibility in the motor caused the strains put on the gearing to be so severe as to strip the teeth and cause other difficulties. Then the control of both motors of the car from either platform was another important point. The claim to the conception of the under running trolley, I be-



lieve, is disputed; I presume it is one of those early contrivances which may have been brought out by others at the same time. It has been adopted everywhere, and is the only true way of getting at the thing. The method of winding the Sprague field magnets is entirely different from all others. They are wound in three sections each; the coils are wound on spools and the spools are slipped on to the fields and the control of speed is effected by different combinations of these coils without the use of wasteful resistances. In some of the systems there are different contrivances in use for varying the speed from zero to the full speed. Resistances are put directly in series, and are gradually cut out as the speed of the car increases, allowing more current to go through the motors. The Sprague company does away with this wasteful resistance by throwing this current, which produces different effects, on the motor. The consequence of this is that the cost of coal per car is less, we claim, than with any other system. I think the claim is admitted. That means a reduction in the operating expenses; it means also a reduction in the original cost. If you can run one hundred cars with seven hundred and fifty horse power in dynamo capacity and engine capacity, it is plain it will be less expensive than if it takes one thousand horse power. The original investment required is, therefore, less than it is with other systems, because the apparatus required is less. The operating expenses are also less. These are the main features of the system.

Since the 1st of August Mr. Edison has been devoting his entire attention to some changes in the motor. They are merely as to mechanical details. The feeds of the motor are now spread slightly so as to allow a little more wire on the field coils, and to vary somewhat the amount of metal in the machine. This makes a somewhat more powerful machine, and in some respects improves the design. The gears have been widened, but the most important advance which has recently been made in electrical railway work is the adoption of the new style of winding the armatures. The old armatures of all systems, with the exception of the Short system, are wound in what is called the Siemens' winding, the wire being put on in such a way that at the end of the armature there is a large bunch, the wires of which cross and recross each other, and not being firmly fastened in place, there is necessarily some chance for the play of the wires, and this results in the fact that the armatures frequently burn out, as we know. The first effect of this method is that you may have a maximum pressure wire touch a zero pressure wire, and the slight motion between these two will cause the insulation to become abraded, and a short circuit on one or two coils will follow. In the new armature that we are bringing out there is no bunching of wires at the end. The coils are wound separately, are inexpensive and may be replaced easily. In the event of one of these coils burning out, the method of repairing the armature would be to loosen up the coils, withdraw the coil that is burned out and replace it by another; the whole operation occupying but a few hours. In the old form the wire is wound in two layers, one over the other. These layers are usually broken, in accordance with the law of things, on the lowest layer, so that you have to unwind the top layer and a good part of the lower. The new winding does away with this entirely. As a matter of fact, we believe our armature will not burn out, except it may be caused by an actual overloading which will melt out the wires. The coils are insulated from each other by fibre insulation. We believe the only cause of burning out in the future will be the overloading of the armature. There is another point, in regard to the car, which ought to be mentioned. In times past there has been some criticism as to the sudden starting of the Sprague car. This is largely a matter of manipulation on the part of the driver, and it is also partly due to the method of winding. Difficulties of that nature have been entirely done away with by the adoption of what we call a slow starting device. It is put in the very instant the car starts, but is cut out immediately and is not in circuit at any time during the operation of the car.

Mr. LEWIS, of Brooklyn: This contrivance is practically a governor; it governs the amount of electricity that goes into the motor.

Mr. HIGGINS: Only for the instant of starting; it prevents too much current going into the motor. When the crank reaches the first notch then the regular system of operation of the fields commences, and is afterward carried out. The switches on the Sprague cars are fire-proof; this is a new device, recently put on. The trolleys of the Sprague system have become the standard. The feeding in system, as it has been called, is distinctively and exclusively an Edison-Sprague invention. The system is this: We have a trolley wire in the center over each track, the wire being about as large as a pencil. It is made of a composition of copper, and has a tensile strength equal to that of drawn steel, while its conductivity approximates to that of copper. It carries only the portion of current used in the actual operation of the car at a given point. The main current is carried by heavy copper feed wires. In the first place we have the main conductor which passes along the whole line. That is connected at intervals with a specially insulated auxiliary feeder, as we call it, which maintains the pressure all the way along the trolley wire simply, as it is to be used by the car passing between poles, or between the auxiliary feeders. The car takes from this feeder the current that is required to operate it until it comes on to the next. By our arrangement of feeders, auxiliary feed wires we lose ten per cent. only, and frequently less, in the entire overhead structure. Thus of one hundred horse power coming out of the station, ninety will go into the cars along the line. You cannot obtain this by the use of a single trolley wire carrying the whole current. I have heard of one case where that

system was adopted, where the pressure fell from 500 volts at the station to 250 volts at the car.

Mr. LEWIS: This feeder system, in connection with your main conductor, means that you can maintain a uniform speed of the car, regardless of grades and loads, furnishing the trolley wire, through the feed, with whatever electricity is required.

Mr. HIGGINS: We never advise the running of car on a heavy grade at full speed, twelve miles an hour. We could arrange to do it, however.

Mr. LEWIS: I asked if it was possible to do that, in view of the fact that an electric railway company might be in competition with a steam road.

Mr. RICHARDSON, of Brooklyn: What speed do you recommend on a grade, say, six or seven feet to the hundred?

Mr. HIGGINS: About eight miles an hour can be attained.

Mr. RICHARDSON: Faster than a pair of horses would be allowed to travel on the level?

Mr. HIGGINS: Yes, sir, I think so. One other point ought to be mentioned. We put up our line in sections. Every two or three thousand feet, more or less, we break the trolley wire, making each section entirely distinct from the others. A trolley wire section is fed from the conductors on the side, and is fed through fusible "cut outs," which, when that line exceeds a given amount, will melt and cut off the entire section of the trolley wire from the source of electricity. In case of accident or fire, a rope can be thrown over the line, and the instant it touches the ground it is dead, and there is no more electricity in it. It can then be taken up and put out of the way.

Mr. LEWIS: You do not put the sections of cut outs close enough to have any effect on your generator?

Mr. HIGGINS: Not any noticeable effect; the dynamos are automatic, and will take care of any load given out to them.

Mr. RICHARDSON: Nearly at the start you spoke of what might be accomplished by electric power at the cost of seventy-five cents a day as against eleven horses costing two dollars a day to feed. What price do you calculate your coal at?

Mr. HIGGINS: Three dollars a ton.

Mr. RICHARDSON: In places where coal costs six dollars, it would be a dollar and a half a day?

Mr. HIGGINS: Yes, sir.

Mr. RICHARDSON: What other items of expense go into the seventy-five cents?

Mr. HIGGINS: I have estimated on the basis of provender for the horses, on the one hand, and coal and water on the other.

Mr. NORMAN McCARTY, of the Thomson-Houston company, said:

The Thomson-Houston company have long recognized the fact that the electrical railway apparatus is not so much an electric as a mechanical problem. We have aimed to get it as simple as possible. We use no commutated fields. We made up our minds that it is a good deal better to spend a little more money for coal, and avoid wear and tear, and we are convinced that we have done the right thing. Quite a number of gentlemen here know as much about our system as I do, who use our apparatus. Our motors are plain series wound. We use the much abused rheostat. The peculiar advantage of this is that we can start our cars without jar. You can hardly tell when it starts; the starting is so quiet and steady. We can make a good deal better time because of this, not having to wait for old people to be seated. We rarely burn a field, and there is no particular reason why we should have any more trouble with our armatures than other people. There is no reason why our field should burn out because all changes of resistance are made by the rheostat. I believe that other companies claim that with the divided fields they save coal. We do not care so much about that, as the increased amount of coal is not excessive. We save wear and tear, and get rid of annoyances. Our latest construction is perfectly simple. Regarding line construction I would say that we are not limited by any patent, the method of construction varying with the conditions of the circuit. There is a patent on a system by which you feed your line at regular intervals; there is no patent on the system by which you feed at irregular intervals.

The impression has got abroad that the Thomson-Houston company is high priced in their charge for electrical apparatus. It seems to me that it is not so much a question of how much per car, as it is how many cars you have got to pay for. If you can operate a road with only one or two per cent. of cars out of service, you can afford to pay more per car than if you have fifteen per cent.

Mr. RICHARDSON: Will you please tell us what is the superior advantage of the Thomson-

Houston over the Sprague system, which makes it economical for those who have to buy, to pay the higher price?

Mr. McCARTY: I do not know that I can do that without criticising the other systems. As for the Thomson-Houston company, our cars and trucks are heavier; motors are heavier and built stronger; the gears are wider, and we have eliminated most of the electrical complications. We do not care about a complicated electrical theory, so much as the mechanical perfection. I think that is the secret of our success.

Mr. RICHARDSON: I ask purely for information. I represent several companies that are contemplating the purchase of electrical apparatus, and have not purchased the first thing yet.

Mr. HASBROUCK, of New York: Two years ago we were invited to take a ride over the Thomson-Houston road in Washington. I would like to know how that road is working?

Mr. McCARTY: It was the first road we started, now nearly two years ago. I think if you were to talk with the president of that road, he will, I believe, tell you that he has the best electrical road in the United States. You can probably get more information from those who are using the system, than from me. We consider the electrical railway problem a mechanical one. We do not use a large armature, we use a small one; and we use it for reasons. We do not use a small trolley wire, we use a large one; and we use that for reasons. Our reason is that it has a greater conductivity. The silicon-bronze has about sixty per cent. of the conductivity of pure copper, our hard-drawn wire has about eighty per cent. We use a trolley wire which has about four or five times the sectional area of the silicon-bronze wire, consequently we get a larger conductivity on that account. We get rid of feed wires along the sides of the street. There is more objection to the wires on the side of the street than through the center. We do feed our lines, but we do not break our circuit, except on extended and complicated circuits. We use the trolley wire as a conductor, and only feed where it is necessary on account of special grades or excessive work.

Mr. SMITH, of Troy: Suppose your trolley wire should fall down?

Mr. McCARTY: If our trolley wire should fall down anyway, we immediately get a short circuit.

Mr. SMITH: Your line would lay dead till that is repaired?

Mr. McCARTY: Yes, sir.

Mr. SMITH: You have no means of cutting out a portion of your line?

Mr. McCARTY: Not on small roads. We do not believe in that for this reason. The experiment was tried in Boston, and it was found that these complications caused other complications; and while they were a protection in certain respects, they were annoyances in others.

Mr. SMITH: Suppose there was a fire at the further end of the road?

Mr. McCARTY: The only way that our road could be shut out would be by a short circuit on the line, and that portion of line would be shut out until the short circuit was broken.

Mr. SMITH: If your line should come to the ground you would get a short circuit? That would have to be repaired before you could operate again.

Mr. McCARTY: What are the chances of your line falling to the ground?

Mr. SMITH: It depends entirely on your own construction.

Mr. McCARTY: We claim that the chances of the wire falling to the ground are small in comparison with the other contrivances failing to work in their proper time, or of working out of their proper time.

Mr. RICHARDSON: I would like to call attention of the members to the fact—it may be known to many of you, and may be known to but few—that the *Boston Daily Advertiser*, one of the most conservative papers in this country, sent out a letter asking information from all cities, from Portland, Me., to Galveston, Texas, in which electric railways are operated; inquiring what systems they use, whether there had been any loss of life in connection with the wire, whether there was any objection to the overhead system on the part of the public, and what had been the



effect on the street railway service of the particular locality. They publish these answers, so far as they have received them, from sixty-four different places. All but four of them were favorable to electricity. Nashville, Tenn., I think, was the only place where there was any loss of life reported. The answer from that city was rather amusing. There had been a wire broken in that city, causing the death of a horse, and a negro woman caught up the wire and threw it over, and it gave her a shock that was very amusing in its effects, but it did her no injury. It killed the horse, but did not hurt the woman, going to show that it is easier to kill a horse than it is to kill a human being. Another objection came from Newport, R. I., where the upper ten were objecting to anything which should popularize riding. The mayor of Rochester responded favorably, as also did the mayors of Troy, Buffalo and Albany.

Mr. F. R. CHINNOCK: I have been connected with the Bell Telephone company of New York, the Bell Telephone company of Boston, and the New York and New Jersey Telephone company. I wish to say a few words about this matter of induction. The telephone companies say they cannot do away with induction; that is all wrong. They can do away with it, if they will only go to expense. The method is well known. They should provide a return metallic circuit.

Mr. CLEMINSHAW, of Troy: We were threatened with injunction suits by the telephone companies. We kept them off until the accidental discovery was made in Albany, of a method of overcoming this interference. We put down two supplemental wires, connected them, and run them through to the station. The thing has worked very effectively, and is an inexpensive method of overcoming the trouble referred to.

Messrs. Hasbrouck, Wyman and McNamara were appointed a committee to nominate officers. On their recommendation officers for the ensuing year were elected as follows: President, Daniel F. Lewis, Brooklyn; first vice president, John N. Beckley, Rochester; second vice president, John S. Foster, New York; secretary and treasurer, William J. Richardson, New York; executive committee, John N. Partridge, Brooklyn, Charles Cleminshaw, Troy, C. Densmore Wyman, New York.

On motion Messrs. Cleminshaw and Watson were appointed a committee to escort the newly elected president to the chair.

On being installed Mr. Lewis said:

In taking the chair I wish to express my sincere thanks for the honor you have conferred upon me. It certainly was a great surprise to me, and I did not intend to take upon myself any additional burden during the year unless it was absolutely necessary. I have nothing to say, specially, except one thing relative to the interests of this Association. The object of the Association is to further the interests of the railroads of the State of New York to the best of our ability, and to exchange such views as we have on matters pertaining to the business, and to indulge in social intercourse and recreation. Our meetings have not been attended as well as they should be, and there has not been as much interest manifested in the Association as we have a right to expect. I fear that the place of meeting has had something to do with it; that the New York and Brooklyn railroad men, the meeting being so near to their places of business, have not attended the meetings as they would have done if the location was further away. But wherever the meeting is held, we must do the best we can to get a large attendance. I think that each member of this Association ought to endeavor to get other railroad companies to join. The subject which we have discussed to-day is an interesting one, and one upon which every railroad company should be informed; and I believe if, during the year, each member of the Association will take an opportunity to speak to the representatives of other companies, the Association will have stronger meetings and we will get better results. I thank you again for your courtesy. [Applause.]

Mr. RICHARDSON then offered the following:

I would move you, sir, that the thanks of this Association are eminently due, and are hereby tendered, President Arthur G. Gates, Secretary John N. Beckley and Treasurer Arthur Lutchford, of the Rochester Railway Company, and their general officers, for the very courteous and liberal way in which they have shown their hospitality in entertaining the members of this Association to-day.

It gives me pleasure in making this motion to say that on no occasion during the history of this Association have the officers of the local companies in the cities in which we have met, shown so much of cordial good will in greeting this Association. I feel, sir, that I am but faintly expressing the feelings of every gentleman who has enjoyed the hospitalities of this day. [Applause.]

Carried unanimously; and a copy of the resolution, under the seal of the Association, signed by the President and Secretary, was ordered to be sent to the President of the Rochester Railway company.

The Association adjourned to meet at the Hotel Metropole, New York City, the third Tuesday in September, 1891.

#### ENTERTAINMENT OF DELEGATES BY THE ROCHESTER RAILWAY COMPANY.

The following invitation and programme, neatly printed on white linen paper, was early in the day distributed among the delegates:

#### CONVENTION OF NEW YORK STATE STREET RAILROAD ASSOCIATION, SEPT. 16, 1890, AT ROCHESTER, N. Y.

The Rochester Railway Company extends to you its hospitality for the day.

The schedule of operation is as follows:  
Meeting of the Association at Powers Hotel at 10:00 o'clock.

Luncheon at the Rochester Club at 1:00 o'clock.  
Drive, leaving the Rochester Club at 2:30 o'clock.  
Board electric cars for Ontario Beach at 4:00 o'clock.  
Return via electric cars and carriages to the Genesee Valley Club, arriving at 5:30 o'clock.

Short meeting of Association at Club House and dinner at 7:00 o'clock.

#### RULES.

1. For this occasion only each street railroad man invited is expected to report for duty in plain clothes.
2. No excuses will be taken. Failure to report for duty promptly will be sufficient cause for immediate expulsion from the Association.
3. The natural contempt which you all feel for the bob-tail cars now in use to Rochester, may be given free expression without fear of giving offense to anybody.
4. If you are caught paying any fare, look out. If you don't see what you want, ask for it, always remembering that for this day you own the town.
5. As the labors of the day will be arduous, you need not report to your immediate superior for duty until Thursday morning, and during Wednesday you are expected to remain as the guest of this company.

#### ROCHESTER RAILWAY COMPANY.

ARTHUR G. YATES, President.  
JOHN N. BECKLEY, Vice President and Secretary.  
ARTHUR LUTCHFORD, Treasurer.  
MURRY A. VERNER, General Manager.  
H. SELLERS MCKEE, Chairman Executive Committee.  
NORMAN McD. CRAWFORD, Ass't General Manager.

#### LUNCH

was served at the Rochester Club at one o'clock; after which followed

#### THE DRIVE.

The party occupied ten open carriages, and were driven through East avenue, across Merriman street, thence to Park avenue. The entire party examined the Park Avenue stables. The route was then down Park avenue to Alexander street, to South avenue, to the reservoir. Thence across to Mt. Hope avenue, to Plymouth avenue, to Church street and through Church street to State street, and thence through Lake avenue to the Charlotte power station and shops. Close examination was made of the electrical apparatus, and then the party boarded a special train of two electric cars and went to Ontario Beach, where all were photographed on the steps of the hotel.

Dinner was had at the Genesee Valley Club at seven o'clock.

#### MENU.

Blue Points	Burgundy Olivier
	Consomme
Tenderloin of Beef	Cauliflower
Pommary and Greno	Roman Punch
	Cigarettes
Partridge	Chickory Salad
	Glace aux Cabinet
Fruit	Roquefort
Coffee	Cigars
	Liqueurs

When the good things were disposed of, Mr. John N. Beckley, Secretary of the Rochester Railway company addressed the company as follows:

In commencing my oration, which I have prepared with great pains and labor, it gives me pleasure to state that one of the highest enjoyments the people of Rochester who are present have ever had, is in having you gentlemen from New York and Brooklyn, Buffalo, Albany and Troy and other cities with us this evening. I desire to assure each of you who is here to-night that it has been a genuine pleasure for us to have you with us. If it had not been for the fact that we do not desire to crowd the mourners too strong, we should have insisted that the next convention should be held in the city of Rochester instead of New York. I desire to call upon somebody at the outset who has arrived at years of discretion, and who has not only had experience with the railroad business, but has had something to do with the affairs of the church. It would not be proper that I should indicate in any way the subject upon which he should address us. I therefore propose to remove the limit, and to allow our friend whom I shall call upon to play this game without regard to limit, and with a view

of casting upon this assemblage a proper degree of awe and inspiration for things that conserve to the church and other interests of this community. I desire to call upon Deacon Richardson, of Brooklyn.

Mr. Wm. Richardson: Mr. Chairman and Gentlemen—I did not understand what the gentleman from Rochester meant by removing the limit. I was going to ask him to use plainer language; but during the course of his address, I heard remarks passed which led me to believe that gentlemen around the table understood the meaning of the term. [Laughter.] I want to say to you gentlemen that I for one have had a very good time in Rochester. I know a great deal more to-night than I did last night; it has been a very instructive and profitable day. I want to publicly express my thanks to the gentleman who read the report for the clear statement which he made on the subject of electric power as a means of traction or propulsion of street cars. I believe that there is a good time coming, when the horse will no longer have to labor in the manner familiar to us at present. I am glad to meet all the gentlemen here, and to have spent so pleasant a time in their company.

Mr. BECKLEY: Now, gentlemen, for several reasons and having in mind the importance of conserving and advancing the interests of the Association which has met here to-day, I desire to say just a word with reference to that matter. Most of you know that as far as I am personally concerned (and I do not desire to obtrude my own personality) and those who are associated with me, are new to the railroad business. This is the first convention of any street railway association that my associates or myself have ever attended. It has been a very satisfactory assemblage from our standpoint; but the result of the observation which we have made during the day has convinced all of us who are here and live in Rochester that the Street Railway Association of the State of New York ought to be made much more of an association than it appears to be at present, with all respect to the gentlemen who are in attendance. We ought to have an association which will have at its annual convention at least one representative from every street railroad corporation in the State of New York. We ought to have an association whose membership will be tied together by bonds of common interest; which will in working for the common good, conserve the individual interests of the respective companies. I think we have that so far as the interests of the companies represented are concerned; but we who are here, interested in street railroads in this State, can if we will, have an organization which will be a tremendous power for the good, not only for the street railroad companies in the state, but for the people of the state as well. It rests entirely with ourselves. I believe you have elected a president for the ensuing year who is filled with the idea of advancing the interests of the organization and the management of the companies by working in and through this organization. I believe if the delegates who are present will take a little pains during the coming year, to talk this matter over with railroad men generally, that before the next convention meets we will have a largely augmented membership; and that instead of having twenty delegates, representing fifteen companies, we will have at least one delegate from every street railroad company in New York State. I believe that it is safe for me to say that we up here will arouse the street railway men in the western part of the State, so that at the next convention in New York City we will have a representative from every one of our western companies. Let each of you do your part as well.

I am now going to call on a very good fellow, whom I have only known for about twelve hours, but feel as if I had known him for sixty years; a capital railroad man, a broad gauge man, who knows how to do good things, and appreciate good things when they are done. I call upon our new president, Mr. Lewis.

Mr. LEWIS: I never was so much over-estimated in my life. I should judge from the remarks that the gentleman has just made that he considers me able to make a speech that would interest the gentlemen present beyond any other person attending the convention; that is a very great mistake. I happen to be at the head of a large railroad corporation in the city of Brooklyn, and have been in the business twenty-three years. If I wanted to follow out the details of operation of a horse railroad, and everything incidental thereto, I think if you did not know anything about the business I could say something that might interest you. I want to personally express my appreciation of the magnificent manner in which the officials of the Rochester Railway company have entertained us to-day. It is something that is new to this association. The entertainment of the delegates has usually been a rather tame affair. I think that should not be so. I think that wherever the association meets there should be provided an entertainment, if possible, equal to this. I think that it will increase the interest in the organization, and in that way it will pave the way of getting at what the intents of the association are. The tendency is towards an overhead electric system; and I think the interest at the next meeting will be just as great as it is to-day, if not greater. There is not a week passes but I hear or see something that shows an improvement in this system; and I think the exchange of views on this question one year from now will be more interesting than it has been to-day.

Mr. Beckley next called upon Mr. John H. McGraw, of the *Street Railway Journal*.

Mr. McGraw: When Artemus Ward was called upon to speak he would rise and cast his eyes over the assemblage, and would say: "Well, gentlemen, what two things are always unexpected, that we cannot account for?" And receiving no reply, he would add: "Twins; twins." I am a good deal in the same state; wholly unprepared; wholly unexpected. I would like



however, to thank the gentlemen, personally and for the technical press, for their kind hospitality to-day. As previous speakers have said, we are all much wiser than we were last night. We have seen something to-day in street railway construction that is unequalled in any other city in the country. The company here is certainly doing things as they should be done. Coming bank to the point of what can and should be done in our organization, I think it would be well, if it can be brought about, that every street railway company in the state should be represented. Much can be gained in many ways by the companies if they will come into this organization and get closer together and work together; much could be accomplished of great benefit to the companies and to the public. I put myself on record as the representative of the *Street Railway Journal* and the technical press, that we will do our best. Our columns are open for all of you, and we will welcome you in taking part in the work. We will do our part if you will do yours. We think that we are doing something already; but we know we are weak and need your help.

Mr. C. Densmore Wyman, when called upon, said: I see that most of the gentlemen who have spoken here to-night have expressed surprise and wonderment at being called upon for a speech. At the beginning of their speech they exhibited a great deal of timidity. On the contrary, I am always prepared for an occasion of this sort, having a large and varied assortment of speeches for presentation whenever called upon. We are under the standard of the electric motor; and, though we have had it explained and discussed at both the State and National conventions, though it has been on exhibition in many forms for some time, I am certain we never had it put so clearly before us, both as to technical explanation and as to absolute illustration, as we have had to-day. I thank you, Mr. President, and the company which you represent, for the entertainment which has been afforded me as the representative of my company.

Brief remarks were also made by Messrs J. N. Partridge, of Brooklyn; C. C. Woodworth, of Rochester; John W. McNamara, of Albany; Porter Norton, of Buffalo; D. B. Hasbrouck, of New York; W. D. Gilbert, of Troy, and E. W. Bliss, of Brooklyn.

The secretary of the Association, Mr. Wm. J. Richardson, was called upon for the closing remarks. He said: In the words of the immortal bard, this is the most unkindest cut of all. Coming up on the electric car to-day, Mr. Beckley said to me: Richardson, have you got ten thousand dollars with you? I said, Why, no, Mr. Beckley, I don't usually carry any such sum of money as that around with me. I said to him, I supposed you were a bloated stockholder in the company here; I am only an impecunious railroad secretary. What do you want it for? He answered, the fact is that is what it has cost us up here to entertain you fellows; and we have got to pass a dividend to make it up. I finally made a bargain with him, that if I told him who the speakers in the party were he would let up on me; and so I am surprised to be called upon. (Laughter.)

We are now about to part, and naturally our thoughts turn homeward; and at this late hour it may be well for me to close the festivities with a few lines repeated by the Hon. Daniel Dougherty, some few years ago, at a meeting of the American Street Railway Association, in Philadelphia.

"There is a land, of every land the pride,  
Beloved by Heaven, o'er all the world beside;  
Where brighter suns dispense serenest light,  
And milder moons imparadise the night;  
A land of beauty, virtue, valor, truth,  
Time-tutored age, and love-exalted youth;  
The wandering mariner, whose eye explores  
The wealthiest isles, the most enchanting shores,  
Views not a realm so bountiful and fair,  
Nor breathes the spirit of a purer air;  
In every clime the magnet of his soul,  
Touch'd by remembrance, trembles to that pole;  
For in this land of Heaven's peculiar grace,  
The heritage of nature's noblest race,  
There is a spot of earth supremely blest,  
A dearer sweeter spot than all the rest,  
Where man, creation's tyrant, casts aside  
His sword and scepter, pageantry and pride,  
While in his soften'd looks benignly blend  
The sire, the son, the husband, brother, friend;  
Here woman reigns; the mother, daughter, wife,  
Strew with fresh flowers the narrow way of life;  
In the clear heaven of her delightful eye,  
An angel guard of love and graces lie;  
Around her knees domestic duties meet,  
And fireside pleasures gambol at her feet.  
'Where shall that land, that spot of earth be found?'  
Art thou a man?—a patriot?—look around;  
O, thou shalt find, how'er thy footsteps roam,  
That land thy country, and that spot thy home!"

Mr. BECKLEY: Permit me at this time, at the end of our unpretentious festivities, to express the hope that the time may very soon come when you will be again with us, and that we may have the pleasure of entertaining all of you again, with such of your friends as you may bring with you on that occasion; and also to express the desire that on that occasion we may cement more closely, if possible, in the brief period of twelve or twenty-four hours, the ties that bind man to man; the ties that make all men the world over kindred.

Mr. Lewis proposed three cheers and a tiger for the officers of the Rochester Railway company, which were given with hearty zest.

**Rochester Convention Notes.**

Major Harry Evans—bluff—big-hearted and genial as ever saw that Johnson Co., lost nothing at the convention.

Mr. Rogers, of the Short Co., was there, and made the merits of his system clearly understood.

President Peckham, of Peckham Car Wheel & Axle Co., was on hand as usual.

Col. Henry M. Watson, one of the most regular attendants of street railway conventions, came in on Tuesday morning, and received many hearty welcomes.

Mr. McNamara's ably prepared paper was listened to with considerable attention by all.

The speech of Col. Henry M. Watson at the banquet at the Genessee Valley Club can justly be regarded as a "golden" one—since the old adage has it that "Silence is golden." If there is one thing above all other that Col. Watson most thoroughly excels in it is in evading post prandialism by reason of "pressing engagements." He hates to make a speech, and would infinitely prefer to have to face the entire New York Legislature at Albany in preference to facing a company of gay banquetters before whom he was called upon to "speechify." (How will this do at the Buffalo convention?)

The electrical press was ably represented in the persons of Messrs. F. L. Blanchard, of *Electric Power*; J. L. Taltavall, of *The Electric Age*, and Mr. Colvin, of *The Electrical World*.

That the speech of Mr. D. D. Hasbrouck, of New York, at the banquet evoked more merriment than any of the others goes without saying. Mr. Hasbrouck is a man of many parts and "infinite jest."

Of Mr. Porter Norton, the attorney of the Buffalo St. Ry. Co., and a director in the Buffalo East Side Co., who responded to the toast, "Buffalo—Rochester's largest suburb"—what can be said, except that he is a very prince of good fellows, and one in whose presence it is almost an impossibility to maintain a dignified demeanor. (More at Buffalo.)

The Gilbert Car Mfg. Co., of Troy, N. Y., had its president, Mr. Edward Gilbert, there. Mr. Gilbert visited Rochester on special business, but happened in at the banquet just in the nick of time to make a happy response to a toast.

Mr. Louis E. Robert represented the Lewis & Fowler Girder Rail Co., of Brooklyn.

Too much praise cannot be bestowed on Messrs. John N. Beckley, Vice-President and Secretary of the Rochester Railway company, and Arthur Luetchford, Treasurer of the same, for the magnificent manner in which the delegates and guests of the convention were entertained. As a toastmaster Mr. Beckley was simply superb, while, as dispensers of unbounded hospitality these two gentlemen have no peers. ("The limit is removed.")

The Thomson-Houston Co., was most ably represented by Mr. Norman McCarty, whose name is identical with the wonderful success of his company. Mr. McCarty is very well known to the street railway fraternity and has hosts of friends in its ranks.

Sidney H. Short, of the Short Electric company, of Cleveland, O., did not reach Rochester until after the adjournment of the convention, but was heartily welcomed by the remaining delegates.

Mr. Dan Pugh looked after the welfare of the John Stephenson company, as usual, and his genial presence contributed in no small degree to the general enjoyment.

Mr. Edward Higgins, whose name is identical with the Sprague motor and the Edison General Electric company, and who has done such splendid work for his company, represented it at the convention, as also did Mr. Chinnock of the same concern.

Captain Candee, of the Okonite Co., New York, came up with the Brooklyn contingent over the West Shore Road, and made many valuable acquaintances at the convention. He had a number of samples of his famous insulated wire, which he showed to the delegates, who exhibited

considerable interest therein. The electric cars upon which the delegates rode at Charlotte are wired with Okonite. Captain Candee will be in attendance with a large exhibit at the Buffalo convention, as also other members of the Okonite company.

**Associations.**

OFFICERS, DATES OF MEETINGS, ETC.

**AMERICAN ST. RY. ASSOCIATION.**

President, Thomas Lowry,.....Minneapolis, Minn.  
First Vice-president, C. Densmore Wyman,....New York  
Second Vice-president, J. C. Schaffer,....Indianapolis, Ind.  
Third Vice-president, Robert McCulloch,....St. Louis, Mo.  
Secretary and Treasurer, Wm. J. Richardson....Brooklyn

**EXECUTIVE COMMITTEE.**

The President, Vice-Presidents, and  
Geo. B. Kerper,.....Cincinnati, O.  
Geo. W. Kiely,.....Toronto, Can.  
R. Semmes,.....Memphis, Tenn.  
F. H. Monks,.....Boston, Mass.  
Francis M. Eppley,.....Orange, N. J.

The annual convention of the Association will be held at Hotel Iroquois, Buffalo, N. Y., commencing on Wednesday, Oct. 15, 1890.

**N. Y. ST. RY. ASSOCIATION.**

President, John N. Partridge,.....Brooklyn  
Vice Presidents, Daniel B. Hasbrouck,.....New York  
P. B. Brayton,.....Syracuse

Secretary and Treasurer, William J. Richardson, Brooklyn  
The annual meeting of the Association will be held in New York City on September 15, 1891, at the Hotel Metropole.

**MASS. ST. RY. ASSOCIATION.**

President, Chas. H. Odell,.....Salem  
Vice-Presidents, H. M. Whitney,.....Boston  
Amos F. Breed,.....Lynn  
F. O. Stearns,.....Swansey

Secretary and Treasurer, J. H. Eaton,.....Lawrence  
Regular meeting day, first Wednesday in each month.

**THE ST. RY. ASSOCIATION OF THE STATE OF NEW JERSEY.**

President, John H. Bonn,.....Hoboken  
Vice-President, S. S. Battin,.....Newark  
Secretary and Treasurer, Charles Y. Bamford,....Trenton

**EXECUTIVE COMMITTEE.**

John H. Bonn,.....Hoboken  
S. S. Battin,.....Newark  
C. Y. Bamford,.....Trenton  
C. B. Thurston,.....Jersey City  
John Hood,.....Camden  
A. Q. Keasbey,.....Elizabeth

**OHIO STATE TRAMWAY ASSOCIATION.**

President, Wm. B. Hayden,.....Columbus  
Vice-President, John N. Stewart,.....Ashtabula  
Secretary, A. E. Lang,.....Toledo  
Treasurer, J. B. Hanna,.....Cleveland

**EXECUTIVE COMMITTEE.**

Ross Mitchell,.....Springfield  
The annual convention of the Association will be held in Columbus, O., on November 19, 1890.

**WESTERN ELECTRIC RAILWAY ASSOCIATION.**

President,.....T. J. Evans, Council Bluffs, Ia.  
Vice-President,.....H. E. Teachout, Des Moines, Ia.  
Secretary,.....W. L. Allen, Davenport, Ia.  
Treasurer,.....W. R. Moore, Moline, Ill.

**NATIONAL ELECTRIC LIGHT ASSOCIATION.**

President,.....M. J. Perry, Providence, R. I.  
1st. V. President,.....E. A. Maher, Albany, N. Y.  
2nd. V. President,.....C. L. Edgar, Boston, Mass.  
Sec. and Treas.,.....A. V. Garratt, New York.

**EXECUTIVE COMMITTEE.**

Chairman,.....C. R. Huntley, Buffalo, N. Y.  
E. R. Weeks,.....Kansas City, Mo.  
James English,.....New Haven, Conn.  
F. A. Armstrong,.....Camden, N. J.  
C. H. Wilmerding,.....Chicago, Ill.  
M. J. Francisco,.....Rutland, Vt.  
A. F. Mason,.....Boston, Mass.  
John A. Sheely,.....New York  
A. J. De Camp,.....Philadelphia Pa.

Next convention will meet at Providence R. I. Nov. 1890

**AMERICAN INSTITUTE OF ELECTRICAL ENGINEERS.**

President,.....Elihu Thomson,  
V. Presidents—Dr. Louis Duncan, Francis R. Upton, T. Cummertford Martin, Edward Weston, Major O. E. Michaelis and Prof. Edward L. Nichols.  
Treasurer, George M. Phelps, 150 Broadway, New York.  
Secretary, Ralph W. Pope, 5 Beekman St., New York.  
Managers—Dr. Schuyler S. Wheeler, Joseph Wetzler; Francis B. Crocker, John W. Howell, Charles Cuttriss, George B. Prescott, Jr., Thomas D. Lockwood, William Mover, Jr., Dr. F. Benedict Aertzog, Prof. Wm. E. Geyer, H. C. Townsend and Henry Van Hoebenburgh.  
Board of Examiners—W. B. Vensize (chairman), F. W. Jones, C. O. Mailloux, E. H. Birdrall and Edward P. Thompson.



### Will You be There?

It is our duty and pleasure, upon the eve of the annual convention of the A. S. R. A. about to convene at Buffalo to communicate with the purveyors of the street railway world as to their intentions in regard to attendance and exhibits. We append the answers to our questions so far as received:

L. F. Jordan & Co., Boston, Mass. "We hope to be present or represented by L. F. Jordan. We shall have an exhibit if possible of our coupling and trolley hangers, also street lighting goods."

A. G. Day, "Kerite" wires and cables, New York. "Shall probably be represented by Geo. B. Prescott, western general agent. Shall not have an exhibit."

Westinghouse Electric Railway company, Pittsburgh "We cannot just at present determine our reply, but trust we will be able to do so later on."

The Belding Motor company, Chicago. "We have the matter under consideration and hope to arrange in time for a good exhibit."

Safety Car Heating and Lighting company, New York. "May possibly have an exhibit of Pintsch Light in one of the cars to be sent by the Pullman company."

The Glidden & Joy Varnish company, Cleveland, Ohio. "Our Mr. Hogan will represent us at Buffalo without doubt."

The Griffin Wheel & Foundry Co., Chicago. "J. R. Ellicott, our general eastern agent will represent us at Buffalo and will exhibit our machined car wheels."

The Pullman Palace Car company, Chicago. "We shall be represented at Buffalo by C. L. Pullman or W. S. Louttil, perhaps both, who will show our double truck electric car."

The Short Electric Railway Co., Cleveland, Ohio. "We shall be represented at Buffalo by Messrs L. H. Short, J. Potter and F. H. Rogers, who will exhibit our motors in operation and appliances in our line."

The Detroit Electrical Works "We shall be represented at Buffalo by Mr. Frank B. Rae, who will exhibit sample truck or working model of the Rae electric st. r'y system

Pratt & Letchworth, Buffalo. "We shall be represented at the A. S. R. A. in this city by Mr. G. S. Crosby, who will exhibit our corrugated steel fastener, hames and saddlery hardware for street railway purposes."

Garrett & Apperson Co., Staunton, Va. "Mr. R. D. Apperson, our secretary and treasurer, will represent us at Buffalo and will show our car wheel and axle."

Edward Beadle, New York. "I shall represent myself at the convention in Buffalo and will exhibit the Eureka folding mat."

The Railway Register Manufacturing Co., New York. "Mr. Edward Beadle will represent us at Buffalo and will exhibit our street car registers."

The American Electric Register Co., Boston, Mass. "We expect to be represented at the Buffalo convention by Mr. W. W. Montgomery, who will exhibit a full line of our registers for use on street railway cars."

The Rochester Car Wheel Co., Rochester, N. Y. "Our president Mr. C. T. Chapin, will represent us at the coming convention and will exhibit our street car wheels, manufactured from Salisbury iron, made in Barr contracting chills."

The Electric Merchandise Co., Chicago. "Mr. W. R. Mason, general manager, will exhibit at the convention—In parlor 'F' Iriquois Hotel, a very complete line of our goods."

Tripp Manufacturing Co., Boston, Mass. "Samuel A. Randall will represent us at Buffalo and will show our electric car truck."

Brownell & Wight Car Co., St. Louis, Mo. "Frederic B. Brownell will represent us at the A. S. R. A. We will not make an exhibit."

Fulton Foundry Co., Cleveland, Ohio. "Expect that T. C. White and C. J. Langdon will

represent us at the annual convention. We do not expect to have an exhibit."

The Adams & Westlake Co, Chicago. "We shall be represented by C. A. Hitchcock, superintendent of brass department, and by F. B. Jones."

The Hathaway & Robison Co., Cleveland, Ohio. "Mr. Charles Hathaway will represent us at the coming convention in Buffalo and will have an exhibit of an electric and cable grip transfer table."

Post & Co., Cincinnati, O. "We shall be represented at the convention in Buffalo by Isaac Kinsey, president. We shall not make an exhibit."

James H. Trimble, New York City. "I shall represent myself at the A. S. R. A. but do not expect to have an exhibit."

Richard Vose, New York City. "Richard Vose himself, assisted by Gus. Suckow, will represent us at Buffalo, but will probably not have an exhibit."

George Cutter, Chicago. "I expect that myself and H. P. Lucas will be at the convention in Buffalo, where we do not at present expect to make an exhibit."

The Morris Tasker Co. Philadelphia. "We shall be represented at the convention of the A. S. R. A. by Mr. Henry Agnew of Chicago, but will not have an exhibit."

The Parrott Varnish Co. Bridgeport, Conn. "We shall be represented at the convention at Buffalo by Henry James and W. W. Seckler, but will not have any exhibit."

J. H. Randall, Boston, Mass. "I shall represent myself at the convention of the A. S. R. A. in Buffalo, but do not expect to make an exhibit."

The Field Engineering Co., New York. "C. J. Field, president of our company, will represent us at the A. S. R. A., but will have no exhibit"

The Dayton Manufacturing Co., Dayton, Ohio. "We expect to be represented at Buffalo by Mr. Joseph Leidinger, but will make no exhibit."

Baltimore Car Wheel company, Baltimore, Md. "We will be represented at Buffalo by Mr. John Pugh probably. We do not expect to make an exhibit."

The Valentine company, New York City. "A. G. Barbier, Nat. Lane and S. F. Miller will represent us at the annual convention, but we will not have an exhibit."

Eugene L. Lynch, Jr., New York City. "I shall, assisted by R. G. Angell, represent our firm at the Buffalo convention. Will not have an exhibit."

J. G. Brill, Philadelphia, Penn. "We shall be represented at the A. S. R. A. convention by John A. Brill, Bernard H. Schmidt, J. A. Hanna and Payson K. Andrews, who will make street exhibit of one full size radial electric motor truck, one section of a vestibule electric motor car, showing pat. vestibule door, brake handle, etc. Our Hall Exhibit will be four bronze models— $\frac{1}{4}$  size—of Brill trucks, with other articles in our line."

The Volk Cable Crossing Grip and Car Brake Co., St. Louis, Mo. "Dr. Morgner will represent us at the Buffalo convention and will exhibit a  $\frac{1}{4}$  size model for cable conduit, illustrating the cable crossing and grip."

Connecticut Motor company, Plantsville, Conn. "We shall be represented at the A. S. R. A. convention by F. O. Rusling, who will probably exhibit a 500 Volt motor."

Steam Gauge and Lantern Co., Syracuse, N. Y. "Mr. E. C. Sawyer will be our representative at the Buffalo convention and he will show our electric street car headlight."

The Johnson company, Johnstown, Penn., "Daniel Coolidge, H. C. Evans, W. E. Boughton and probably Secretary McLane, will represent us at the Buffalo convention, and will exhibit samples of rails."

Wm. B. Knight, Kansas City, Mo. "I expect to attend the A. S. R. A. convention myself."

Okonite Co., New York. "We shall be repre-

presented at the Buffalo convention by Willard L. Candee and T. McCoubray, and exhibit every description of wires suitable for car work and the conducting of electricity for both overhead, underground and submarine work."

The Michigan Stove company Detroit, Mich: "We will be represented at Buffalo, and will make an exhibit that will be satisfactory all around."

### REPUBLIC OF URUGUAY,

MONTEVIDEO, June 31, 1890.—Montevideo, the capital of the Republic of Uruguay, affords just as much news upon tramways as Buenos Aires, capital of the Argentine Republic, does.

The tramways here are abundant like in Argentina's capital, but in this city (Montevideo) they do not carry the vast amount of passengers as is to be seen on and in the Buenos Airean tram cars every day throughout the year.

At the present day there are four or five different companies running their cars through and about the skirts of the city and there are many more lines already planned out; one amongst many that will shortly be opened is a line from the grand Bathing Establishment and the recently constructed National Hotel along the south side of the city, to Plaza Ramirez and the Cordon; a line which is well calculated to satisfy a long felt want in a thickly populated part of the town.

Comparatively speaking, it is but a few years since the first tram was run in Montevideo, but, year after year, lines have been laid till now a tram passes through almost every street of the city, and this kind of public conveyance has become such a public necessity that tramway companies are recognized as the best paying concerns here and the safest investment for capital; tram shares in every line being at a highly respectable premium.

To nearly all trams are attached three horses and four for the hills, the cars are smaller than those seen in the Argentine capital, some do seat more than sixteen persons, while the general size can hold (without squeezing) from 20 to 24.

The tramway companies of Montevideo seem to have more respect for cleanliness, and feeling for the sturdy little rough bred native horse, than their brethren on the other side of the river, for I notice particularly, how clean the cars are kept and that there is no "off-tracks" or running the car half way onto the foot path as is very often the case in Buenos Aires, when turning a rather sharp corner. The horses here seem to be stronger and better looked after than those working under Argentine managed tram companies, for I have not discovered animals working with sore shoulders and cut knees as is so often seen by pedestrians in Buenos Aires, but yet not by the stable or yard manager. Singular it is.

On the 17th inst. a fearful accident occurred in this city in the Southern tram line. Some twenty men and boys were going down the line on a trolley, when the break got loose, and it ran down at a fearful speed overturning at the bottom and flinging all its occupants over the embankment on the sharp rocks below. Two of the injured have since died. The accident created a great and most painful sensation.

F. W. N. LODIA.

### MONTEREY, MEXICO, AND THE SANTA CATALINA AND TOPO CHICO HOT SPRINGS MOTOR RAILWAY.

Gen. Manager Jules A. Randle of the above lines writes us that in strict accord with the unwritten law which relegates the festive mule to his thistle pasture he has just purchased a model motor from the Baldwin works of Philadelphia, Pa., which in forty minutes spans the round trip over the four and one half miles which lie between the historic city of Monterey and the Springs, whose waters are a panacea for most of the physical ills to which flesh is heir.

The Minneapolis Street Railway company is making rapid strides in the installation of their electric power house. The new engine of 1,000 horse power, which was built by E. P. Allis & Co., of Milwaukee, Wis., was started on Thursday, Sept. 18th, for a trial, and gave entire satisfaction. This engine will drive upwards of 20 generators. The company has recently installed a No. 60 generator of 500 volts.



## ANNUAL CONVENTION OF THE ASSOCIATION OF

### ELISON ILLUMINATING COMPANIES,

was held at the West Hotel, Minneapolis, Minn., and was opened by President Jno. I. Beggs, at 11 30, Tuesday, September 16th, who explained that session had been postponed by action of the Executive Committee, suspending the clause of the by-laws, providing for the holding of the annual meeting on the second Tuesday of August, on account of the holding of the Exposition during the present month. The closing session was held Wednesday P. M. The time and plan of the next Convention to be determined by a committee appointed for that purpose. The members present at the opening session were

EDISON GENERAL ELECTRIC COMPANY, Samuel Insull, Second Vice-President, H. Ward Leonard, General Manager Light and Power Department, John Muir, General Manager Railway Department, Francis R. Upton, General Manager Lamp Manufacturing Department, F. E. Jackson, Inspector Lamp Manufacturing Department, Wilson S. Howell, Inspector Lamp Manufacturing Department, W. J. Jenks, Legal Department, M. J. Sullivan, official stenographer, L. Stieringer.

ILLUMINATING COMPANIES. John I. Beggs, Director Harrisburgh E. L. Co., Harrisburgh, Pa., Geo. H. Finn, Secretary and Treasurer Edison Co., St. Paul, Minn., C. H. Maxey, Secretary Edison L. & P. Co., Minneapolis, Minn., Oscar Erricon, Superintendent the Cascade Milling Co., Sioux Falls, Edwin R. Weeks, Gen. Man. E. E. L. & P. Co., Kansas City, Mo., Frederick Nicholl, Man. and Sec. Toronto Incandescent E. L. Co., Toronto, Canada, F. G. Kurz, Supt. Appleton E. L. Co., Appleton, Wis., B. L. Smith, Assistant Secretary and Superintendent Laramie E. Gas Light & Fuel Co., Laramie, Wyoming, W. D. Kurz, Supt. E. L. & P. Co., LaCrosse, Wis., John R. Markle, Director E. L. & Fuel Gas Co., Grand Rapids, Mich., Wm. L. Church, Supt. The Chicago Edison Co., Chicago, Ill., M. A. Beal, Sec. and Treas. Forest City E. L. & P. Co., W. H. Van Sickle, Mgr. Edison Sault L. & P. Co., Sault Ste. Marie, W. F. Woolin, Supt. E. E. L. Co., York, Pa., Leigh Carroll, President E. E. I. Co., Birmingham, Ala., C. L. Edgar, Gen. Man. E. E. L. Co., Boston, Mass., J. A. Colby, Sec. and Mgr. Des Moines Edison Light Co., W. S. Barstow, Asst. Supt. E. E. I. Co., Brooklyn, New York, S. J. Smith, Gen. Oper. Supt. The E. E. I. Co., New York, Chr. Wuestenfeld, Manager Elgin City Ry. Co., Elgin, Ill., A. L. Smith, President Appleton Edison L. Co., Appleton, Wis., C. P. Gilbert, Sec. and Mgr. E. I. Co., Detroit, Mich., Hoyt Post, Director and Attorney E. I. Co., Detroit, Mich.

The following named officers and committee were elected: President, John I. Beggs; Vice-President, C. L. Edgar; Secretary, W. J. Jenks; Treasurer, Wilson S. Howell. Executive Committee: John I. Beggs, ex-officio, A. L. Smith, Appleton, Wis.; Thos. P. Merritt, Reading, Pa.; E. R. Weeks, Kansas City, Mo.; C. P. Gilbert, Detroit, Mich.; Leigh Carroll, Birmingham, Ala.

Electrical and other journals were represented by the following gentlemen: W. F. Collins, "Electrical Engineer." A. C. Dyrborow and J. B. O'Hara, "Western Electrician." E. J. Powers, "Electrical Industries." Thos. R. Taltavall, "Electrical Age." Fred DeLand, "Electrical World." D. B. Dean, "Electrical Review." Jno. Roberts, "STREET RAILWAY GAZETTE."

The following paper was presented by W. J. Jenks:

#### NATIONAL CODE OF INSURANCE RULES AFFECTING ELECTRIC AND POWER INSTALLATION.

It has often been noted as one of the evidences of the incomplete development of the present system of electric light and power construction, that the rules enforced by the underwriters in different sections of the country are so widely different as to make it impossible for a construction firm in Boston to be at all certain of being able, without further education, to do work in Philadelphia acceptable to the insurance inspector, or for a supply man in Chicago to be sure that he is furnishing material which the underwriters of Cincinnati will approve.

From the time of the formation of the original rules for wiring of buildings for incandescent lamps (resulting from the conferences of the New York Board with the practical people of the Edison company) to the present, all codes used by the insurance fraternity have, while annually growing nearer to a standard, embodied so many uncertain quantities and individual notions that it

has been hard to predict what a year might bring forth in modification of existing requirements. Very much has been done by the earnest efforts of the inspectors of the New England Exchange, and the New York State Board, as well as by the practical labors of the Philadelphia Fire Patrol and the Chicago city officials; but it has been reserved for the present year to evolve a plan which promises to speedily revolutionize all the minor distinctions which exist in the codes heretofore enforced by the insurance inspectors of different sections in one National code, which, by reason of the authority by which it is supported, will be adopted by a large majority, if not by the entire fraternity of the insurance men in the United States.

At the Kansas City meeting of February last, the National Electric Light Association chose a committee for the purpose of conferring with the insurance people, and, if possible, of setting on foot such measures as might result in this uniform code. This action by which this committee was brought into existence is expressed in the vote taken at the session of February as follows:

Pursuant to this plan the secretary of the committee, Mr. George Cutter, of Chicago, entered into correspondence with the representatives of the active executive insurance associations, and with the leading electric light companies of the country, and the result of his persistent and intelligent endeavors in this direction appeared at a meeting of the committee and the representatives of the two interests, which convened at the Stockton hotel, Cape May, August 16th, three days in advance of the first session of the convention of the National Association.

The committee held its first meeting on Saturday evening, Mr. Cutter in the chair, and the names of the remaining gentlemen present were as follows:

C. M. Goddard, Inspector New England Insurance Exchange, Boston.

E. C. North, Chairman Electric Light Committee, New England Insurance Exchange.

S. E. Barton, President of the Electric Mutual Insurance Co., Boston.

Wm. Brophy, Chief Inspector Mutual Insurance Co., Boston, and representatives of the Mutual Fire Insurance companies, of New England.

F. E. Cabot, Inspector Boston Fire Underwriters' Union.

W. H. McDevitt, Inspector Philadelphia Fire Underwriters' Association.

J. P. Barrett, City Electrician, Chicago, Ill., and also representatives of the Chicago Board of Fire Underwriters.

W. A. Anderson, Secretary New York Board of Fire Underwriters, and also Secretary of the National Board of Fire Underwriters.

W. D. L. Boughton, Chairman Electric Light Committee, New York Board of Fire Underwriters.

H. C. Kline, Chairman of the Electric Light Committee Underwriters' Association of the Middle Department, Philadelphia.

J. J. Babcock, Chairman Light Committee Insurance Association of the State of New York, Binghamton, N. Y.

C. E. Bliven, Chairman Electric Light Committee, Western Union Fire Underwriters' Association, Chicago, Ill., and representatives of the Fire Underwriters' Association of the Northwest.

J. S. Alfred, Inspector Southern Tariff Association, Atlantic, Ga.

R. H. McMath, Representative St. Louis Board of Fire Underwriters.

J. R. Lovejoy, Thomson-Houston Electric Co., Boston, Mass.

P. H. Alexander, Westinghouse Electric Co., New York.

W. J. Jenks, Edison General Electric Co., New York.

Mr. Cutter was chosen secretary, and the chairman stated the object of the meeting as being the securing of a harmony of ideas between the electric light and insurance interests.

An extended discussion of the proper basis for a code of generic or fundamental rules extended through several sessions, and resulted in an outline representing practically the unanimous views of the gentlemen present. Exhaustive statements of the reasons for the positions assumed in this initial code were made by the electric light representatives and agreed to by the insurance inspectors, as embodying the results of their experience. A special committee presented at the second session a code of by-laws as the basis of a permanent organization, which was, early in the deliberations of the meeting, decided upon as the only practical method of securing and perpetuating an influence sufficiently positive and controlling to be permanent. A concise summary of a few of these by laws will illustrate the scope of the work to be done, the solidity of the basis upon which the organization was effected, and the standing of the insurance representatives composing the organization is a guarantee of that important work in that executive direction in which former efforts have been lacking.

The name decided upon was "The National Electric Insurance Bureau," and the object is stated by the by-laws to be "the harmonizing of the electric interests and the fire insurance interests in the United States."

It is also provided that in addition to the membership indicated by the names of those in attendance, one member may be chosen by the National Telephone Association, one of the Western Union Telegraph company, one by the Postal Telegraph company, one by the National Association of Fire Engineers, one of the Underwriters' Association of the Pacific Union States, and such other insurance representatives as may apply for membership, and be deemed eligible.

It was settled that as a method of completing an organization for the opening year, the gentlemen of the committee chosen by the National Association, and representatives of the other organizations above named

having been called together by the original committee, should be members of the Bureau until the next morning, or until their successors were chosen.

Officers were elected as follows: President, Major C. E. Bliven, Chicago; Secretary and Treasurer, George Cutter, Chicago; Executive Committee, Messrs. Bliven, Brophy, Lovejoy, Jenks, Anderson, McDevitt and Cutter.

A committee, consisting of Messrs. Barrett, Goddard and McMath, was chosen to gather information regarding city and States laws bearing upon electric interests.

After a very careful discussion of the best methods of attaining the primal object of the meeting, namely, a uniform code of rules which shall be national in their application, the following gentlemen were chosen a committee to outline such a code: Messrs. Bliven, Cutter, McDevitt, Cabot and Jenks.

The deliberations of the meeting consumed six sessions and an adjournment was made on Monday evening, August 18th, subject to the call of the president, or to the time of the annual meeting, which, by the by-laws, was fixed to be held sometime during August of each year at such day and place as the Executive Committee may determine.

The committee charged with the work of codifying rules were instructed to secure as many different sets of codes as may be at present in force by any of the State or local boards throughout the country, and by such light and power companies as may have given careful thought to this matter. It is proposed that these shall be, if possible, harmonized and condensed, and that a draft embodying whatever may be desirable from all be sent by the committee to the organizations from which the different codes emanated for criticism and suggestion. Also, that on return of such criticisms a final arrangement may be made and an improved code thus prepared, submitted to a future meeting of the Bureau for adoption.

It will at once be seen that from the fact that the large majority of the members of this Bureau are executive insurance officers, and that as they represent one hundred and fifty or more of the leading insurance companies doing business throughout the United States, the adoption of any code of rules by such a body will mean their immediate enforcement throughout the territory over which they have control. Copies will at once be sent to the representatives of these numerous companies, including compact agents and local boards, and the inspectors will be provided with the code as a method of instruction, simply forming an addition to their previous duty for the general inspection of buildings, and thus a most effective plan of determining whether or not proper methods have been pursued will at once be adopted by the underwriters. Hence, by the operation of the logical mandatory plan, a rigid surveillance will be exercised over all construction firms, and a great advantage immediately gained by the application of a uniform standard throughout the country.

The significance of the action taken, and the probable results, may be better understood when it is remembered that this is the first systematic effort made to secure the adoption of a uniform code of rules by the executive managers of a large number of the different insurance organizations represented by the several associations of the United States.

#### Book Notices.

*The Journal of Rail Road Car Heating*, monthly, New York.

Heat, light and pure air in the railway car, are the ends and the aims advocated by Mr. Frank Mellersh, editor, and the assurance is sufficient that modern appliances are very soon to replace a line of destructive and health destroying makeshifts.

*Metal Railroad Ties*, by E. E. Russell Tratman, C. E. Published in connection with the Forestry Division of the Department of Agriculture, Hon. J. M. Rusk, Secretary, Washington, D. C.

With a world of thought and care Engineer Tratman has apparently reached to the four corners of the globe for historical, statistical and illustrative information tending to show that the substitution for wood by metal ties, is not only a necessity, considered in an agricultural sense, but a pre-eminently essential for public safety; a substitution which must be a success because of its direct appeal to finance. As we understand it, Mr. Tratman does not commit himself to any particular invention or design, although such knowledge as he displays would not go unrequited were our railway managers to awake to the full sense of their duties in this line. We have made extensive experiments in this field, and know that the engineer has struck the key note of success.

THE POLYTECHNIC is the name of a new magazine to be published in Chicago, the initial number of which will be issued October 1st. Like the London magazine of that name it will be the organ of a Polytechnic Institute, which in this case has been lately started in Chicago, and will



be modelled after the famous London institute of similar name, an interesting account of which was given in the "Century" for June. The first number will be largely descriptive of the work of the Institute, especially its Trade Schools, a peculiar feature of which is that students may earn their expenses while in attendance, and can learn almost any trade. As this promises to solve the vexed apprenticeship question, all Master Associations are warm supporters of the movement. An article on the new Evening Medical College of Chicago is also included in this number. The ladies will be interested in the description of the Cooking, Millinery and Dress-making Schools of the Chicago Polytechnic Institute. Published at the s.e. corner Madison Street and Fifth Ave., Chicago, Ill. Sample copy, 10 cts.

The *Sketch Catalogue* of the Great Western Electric Supply company, 190 192 Fifth avenue, Chicago, gives a detailed description and prices of articles which they carry in stock. The catalogue, although it contains 120 pages of descriptive matter, can not convey an idea of the immense quantity of material their warehouse contains. This house, although it has not been in existence many months, has, under the able management of Mr. George Cutter, attained a well deserved celebrity for being among the foremost of electrical supply houses in this country, as they carry everything in the electrical outfitting line and supply orders on the shortest notice.

*The National Car and Locomotive Builder Supplement*, John N. Reynolds, general manager, 140 Nassau street, New York City: Is whether it be intended or not, the Bible of the purchasing agent. Every valuable commodity upon which the railway manager must depend for construction and operation of his lines, is herein, not only well illustrated, but its claims for purchase are succinctly set forth; and as though this were not enough, the publisher indicates by geographical description, all the lines in this country upon which the railway wheels turn.

*Scribner's Magazine* for September contains the first of three articles on our New Navy—the results of the voyage which R. F. Zogbaum, the artist and writer, recently made on the flagship of the "White Squadron," expressly for this magazine; Donald G. Mitchell's very richly illustrated paper on "The Country House," which is written in his most charming style, and is full of his love for rural life; Thomas Stevens's discussion of the commercial importance and relations of the River and Lake Systems of Africa—the fruit of his journey to meet Stanley; a description of Heligoland (recently ceded by Great Britain to Germany), by one who has visited that picturesque island; one of several papers by Professor N. S. Shaler (author of "The Aspect of the Earth")—describing the effects which physical conditions have had on the character of the populations of various states; another clear and valuable contribution, by an eminent Chicago lawyer, to the series on "The Rights of the Citizen;" and fiction, poems, and essays, with a clever number of "The Point of View." The illustrations represent the best work of skillful artists and engravers.

*Whipple's Electric, Gas and Street Railway Directory*, 2nd year. The Fred H. Whipple Co., Detroit, Mich.

With about a hundred and fifty pages last year Mr. Whipple came before the public as a compiler of electrical history, and such was the avidity with which that volume was seized by those who desired a comprehensive knowledge of nature's most mysterious and most powerful agent, that the edition was soon exhausted, and the compiler must have devoted almost his whole time to the preparation of this year's magnificent volume of nearly six hundred pages.

*The National Corporation Reporter*, Chicago.

Although they don't quite say so, it becomes self-evident in scanning the salutatory of this journal that the managers intend to prove that corporations *have souls*; that the successful unification of labor, industry and capital must have far-reaching influences for good throughout the industrial world.

## LEGAL DECISIONS. COURTS OF LAST APPEAL.

SUFFICIENCY OF ALLEGATION OF PATENT.—*American Cable Railway Co. v. Mayor, etc., of the City of New York*; Circuit Court of the United States, Southern District of New York, April 14, 1890. 42 Fed. Rep. 61.

SHIPMAN, J. This is general demurrer to the complainant's bill in equity to restrain the infringement of letters patent. The bill alleges that the patentee was the original, first, and sole inventor of a certain new and useful improvement in the construction of cable railways, fully described in the specification of the said letters patent, which had not been patented to himself or to others, with his knowledge or consent, in any country, and had not, to his or the orator's knowledge, been in public use or on sale in the United States for more than two years prior to his said application for letters patent, and had not ever been known or used or described in any printed publication in this or any foreign country prior to his invention and discovery thereof, and application for letters patent of the United States therefor. The grounds of demurrer which were stated on the argument are: First, that there is no averment that the invention had not been patented in this or any foreign country before the date of the invention, but that it is simply alleged that it had not been patented with his knowledge or consent, which is an immaterial matter, and is not the fact which is required by section 4886; and, secondly, that the allegation in regard to public use or sale prior to the application is simply that the improvement had not been in such use to the patentee's or the complainant's knowledge, which is also an immaterial matter. The averments do not use the language of the statute, and are not in the customary form, and some of them are open to the objections which have been urged by the defendants; but, when all the averments are taken together, I think that they state, in an informal way, the facts which are prerequisites to a valid patent. The bill alleges that the patentee was the original and first inventor of the subsequently described new and useful improvement, which had never, prior to his invention thereof, been known or used or described in any printed publication in this or any foreign country. This averment is equivalent to one formally saying that the invention had not been known or used by others in this country, and had not been patented or described in this or a foreign country; for, if it had never been known by anybody in this or any other country before the date of the invention, it could not have been patented. The pleader would have made a more simple and more neat paragraph if he had followed the language of the statute; but I think that his averments are adequate, and they apparently comply with the averments which were regarded as sufficient in *McCoy v. Nelson*, 121 U. S. 484, 7 Sup. Ct. Rep. 1000. The demurrer is not sustained.

CONSTRUCTION OF STATUTES AND LICENSE.—*Mayor, etc., of New York v. Eighth Ave. Ry. Co.*; Court of Appeals of New York, Jan. 28, 1890. 23 N. E. Rep. 550.

The Court say:—"Under laws N. Y. 1874, c. 478, requiring the Eighth Avenue Railroad company to extend its route, and providing that when the extension shall be completed it shall use and operate its road, 'subject only to the provisions of the general railroad act of this state, with its amendments,' that company is not relieved from its agreement to pay license fees to the city, as laws 1854, c. 140, providing that common councils of cities shall not permit the construction of railroads, beginning and terminating in the city, for transportation of passengers, without consent of property owners on the street, being, *in pari materia*, will be considered as an amendment of the general act, and by this statute the common council is given power when property owners consent, to grant authority to establish a street railroad upon such terms, conditions, and stipulations as it sees fit.

"Though the grant of authority by a common council to operate a street railway on payment of certain license fees was invalid for lack of

authority in the council, yet the grant and contract with the company have been ratified by laws N. Y. 1854, c. 140, under which act, in part, the company was incorporated, the agreement to pay the license also became valid.

"The passage of an ordinance imposing a penalty for failure to procure a license, will not prevent the city from suing for the license fee."

LIABILITY FOR COLLISION WITH VEHICLES.—*Chicago W. D. Ry. v. Igraham*; Supreme Court of Illinois, Jan. 21, 1890. 23 N. E. Rep. 350.

An appeal from the judgment for plaintiff. The Court say:—"That in an action for injuries caused by collision with a street-car, damages may be recovered both for injuries to plaintiff's person and to his horse and buggy, though they are both set up in the same count of the declaration, when no demurrer is filed, and no objection is made to the introduction of evidence as to such injuries. In such an action, instructing the jury that mere omission to perform any duty is not sufficient to render defendant liable, 'unless such omission caused the injury complained of,' is not reversible error, where other instructions explain the degree of care required of defendant, and state the doctrine of comparative negligence. In such an action, an instruction that a street-car company is entitled to the track on meeting other vehicles, and that the latter should yield the right of the track to the car, is misleading, as indicating that a street-car company is not bound to exercise due care to prevent a collision. In such an action, after a witness has testified regarding the accident, and has been asked on cross-examination, whether he did not say, shortly after the accident, that he could not see the plaintiff, evidence that he said he could not see 'the accident' is admissible, where objection to the form of the statement is not made at the trial.

### Business Notes.

The house of H. A. Rogers, 19 John street, New York City, is one of the oldest establishments in the country, doing business in railway, manufacturers' and machinists' supplies. Mr. Rogers is an indefatigable worker, and has built up a large and steady demand for the numerous mechanical specialties which he handles. The celebrated Moncrief Scotch gauge glasses, for which he is sole agent in the United States, have an enormous sale, and have made Mr. Rogers widely known in manufacturing and railway circles.

It is reported, that George Westinghouse, Jr., states that shops for the exclusive making of the Westinghouse street railway equipments, will be built near the Pullman shops, and will probably cost about \$17,000,000. The Pittsburg shops of Westinghouse will not be affected.

The Walker Manufacturing Co., of Cleveland, O., has received orders for four of its differential drums from the Citizens' Cable Railway Co., of St. Louis, Mo., to replace four solid drums now in use. Two differential drums had previously been supplied the Citizens' Cable Railway Co., replacing solid drums, making six in all supplied. The James Street Construction Co., of Seattle, Wash., has also ordered two differential drums.

Dorner & Dutton, Cleveland, O., are running their shops day and night turning out DuPont motor trucks, one of their specialties. Mr. W. A. Dutton is now on an extended western trip.

Lemuel Wm. Serrell, M. E., of 115 Broadway, N. Y., states that he is meeting with great success in selling the Milliken patent pole for Electric railways, that he recently closed with Murray Verner, Esq., of the Verner-McKee syndicate, for poles for the entire city of Buffalo; that he has already received orders from the Rapid Transit Street Ry. Co., Newark, N. J.; Troy & Lansingburgh Street Ry. Co., Troy, N. Y.; Essex Passenger Ry. Co., Newark, N. J.; Buffalo Street Ry. Co., Buffalo, N. Y.; Pittsburg & Birmingham Traction Co., Pittsburg, Pa.; Passaic, Garfield & Clifton Street Ry. Co., Passaic, N. J., and Jersey City & Bergen Street Ry. Co., Jersey City, N. J., and that he has taken orders for over 6,000 poles during the last three months.



## STREET RAILWAY NEWS.

See also "New Enterprises," "Extensions," "Elections," etc.

The following data are compiled with all possible care, but the publishers, receiving news, as they do, from almost every state, territory and country, cannot be held responsible for errors, as it would be wholly impossible to obtain a verification of each item received by them in time for each issue.

## ALABAMA.

**Birmingham**—Work has been commenced on the dummy line now being built by Gen. C. M. Shelly and associates to Avondale.

## CALIFORNIA.

**Sacramento**—It is reported that the Central Street Ry. will be converted into an electric line if the council will grant the privilege.

## COLORADO.

**Denver**—The Denver City Street Ry. Co. is considering the advantages of electric over animal traction.

The Berkeley Rapid Transit Co. is considering the advisability of a change from steam to electric power.

## CONNECTICUT.

**Bridgeport**—The following gentlemen have purchased the Bridgeport Horse Railroad: Charles M. Everest, A. G. Yates, W. S. Kimball, A. V. Lutchford, J. N. Beckley, A. E. Perkins, Nathan McKee, A. M. Verner, Sherman H. Hubbard and C. A. Hotchkiss.

## DELAWARE.

**Wilmington**—The Wilmington City Passenger Co. has received permission to lay a double track.

A petition of the Front and Union Street Ry. company, to be allowed to use electricity, was granted.

## IDAHO.

**Boise City**—It is announced that work will shortly be commenced on the Boise City Street Ry. Co.

## ILLINOIS.

**Aurora**—Work on the Aurora Electric Street railway will be prosecuted without delay.

**Cairo**—The Cairo Street Ry. Co. contemplates the raising of its capital stock to \$100,000.

The ordinance authorizing the construction of the electric street railway, has been accepted by the company. Work will be commenced as soon as possible.

**Champaign**—The Champaign and Urbana Street Ry. contemplates the introduction of the electric system.

## IOWA.

**Davenport**—The council has passed an ordinance, granting right of way on Second Street between Brady and Harrison Streets to the Davenport Electric Railway company.

**Sioux City**—The city council has given the Sioux City Street Ry. Co. the right to use electricity on its road.

The Sioux City Rapid Transit company has increased its paid-up capital stock to \$100,000

## LOUISIANA.

**Shreveport**—The City Street Ry. will, it is stated, adopt the electric system in lieu of the present animal traction, and will replace the present track with new ties and rails.

## MASSACHUSETTS.

**Lynn**—Permission has been granted the Lynn & Boston Railroad to lay a double track on Lynnfield Street to Forest Park, also to operate several lines by electric systems.

**Salem**—The Essex Electric Street Ry. Co. has been sold to the Lynn & Boston Railway.

**Springfield**—The Springfield Street Ry. Co. will change its name to the Pittsfield Electric Street Ry. Co. A list of directors will be found under the head of Elections in the present issue.

## MICHIGAN.

**Menominee**—Iron Mountain is now agitating the subject of a street-car line.

**Owosso**—The Owosso Street Ry. will connect this town with Corunna.

## MISSISSIPPI.

**Meridian**—The contract for the construction of the Bonita Park Dummy Line has been awarded, and work will be pushed forward as rapidly as possible.

## MISSOURI.

**Carthage**—L. B. Doughtrey and G. D. Sleeper

who recently purchased the street railway here, have had the franchise extended forty years.

**Kansas City**—The Consolidated City and Chelsea Park Ry. Co. has executed a deed of trust to the Metropolitan Trust Co. of New York, to secure \$100,000 in mortgage bonds, to construct and equip the proposed line.

**St. Joseph**—A meeting of the People's Street Ry. and Electric Light and Power Co. will be held on October 10th, to vote on the question of increasing its capital stock from \$250,000 to \$600,000., and its bonded indebtedness from \$250,000 to \$600,000

## NEBRASKA.

**Omaha**—The Belt Line Ry., it is reported, will be double tracked in the near future.

## NEW JERSEY.

**Newark**—The New Brunswick City Railroad which was sold lately to W. B. Price at auction, to foreclose mortgage of \$50,000, held by the American Trust Co. of New York, will be re-organized, it is announced, and put into first-class working order.

**Orange**—The common council has granted permission to the Newark Passenger Ry. to use electricity as motive power.

**Paterson**—It is said that the Haledon Line will test the advantages of the electrical system over animal traction. If satisfactory, this motor will be introduced on all the lines.

**Trenton**—It is reported that the Trenton Horse Railroad Co. purposes to adopt electricity in the near future.

The Horse Ry. Co. has secured the right of way to Hamilton Township.

## NEW YORK.

**Brooklyn**—It is announced that the Brooklyn City Railroad Co. has concluded to adopt the overhead system of electric wires.

The new road to be built between the city of Brooklyn and town of New Utrecht by the Brooklyn City Railroad Co., will use either cable or electric motor.

The Coney Island & Brooklyn Railroad are desirous of using the electric system on their Ocean Parkway extension.

**Glens Falls**—It is stated that the Glens Falls, Sandy Hill and Fort Edward Street Ry. is considering the introduction of the electric system.

**New York**—The Central Cross town Street Railroad and the Christopher & Tenth Street Line have consolidated.

**Rochester**—The agreement between the Rochester Electric Ry. and the city in regard to building a local street car line, has been duly signed and accepted.

## OHIO.

**Akron**—The Akron Street Ry. Co. has increased its capital stock from \$200,000 to \$300,000.

**Cincinnati**—It is reported that the Newport Street Railway Line will shortly be operated by electricity.

## OREGON.

**Astoria**—C. E. Belding proposes to build a local electric street railway line if the citizens will guarantee sufficient subsidy.

**Jacksonville**—Crawford & Howell, of Corvallis, propose to build the Jacksonville and Medford motor railway if the citizens will give them a bonus of \$20,000.

**Portland**—The Portland Cable Railroad Co. has decided to increase its capital stock from \$300,000 to \$500,000.

The Trans-continental Street Ry. Co. which has lately been sold to the Willamette Bridge company, will be changed into an electric road.

## PENNSYLVANIA.

**Pittsburgh**—Work is being vigorously pushed ahead on the Squirrel Hill Electric Railroad.

The directors of the Pittsburgh, Allegheny & Manchester Traction Co. which leased the Pittsburgh, Allegheny & Manchester Ry. Co., have awarded the contract for putting down the new tracks.

**Washington**—The Washington Electric Street Railroad Co. has been sold to local capitalists who have decided to push its construction to completion as soon as possible.

## SOUTH CAROLINA.

**Charleston**—It is reported that the Enterprise Street Railroad Co. will shortly adopt the electrical system.

## TENNESSEE.

**Knoxville**—An ordinance has been passed approving and authorizing the Elmwood Street Railroad company, to consolidate with the Knoxville Street Railroad company, also to use electricity as a motive power.

**Nashville**—The Nashville Electric Ry. and Power Co. has filed with the city recorder its acceptance of right of way as granted, together with bond as required, to build road.

## TEXAS.

**Dallas**—It is reported that the Dallas Consolidated Traction Ry. company, which recently bought out the Dallas Consolidated Street Ry. company, will, as soon as practicable, equip the line on the electric system.

It is announced that Philadelphia capitalists represented by George G. Graham, have purchased a controlling interest in the Dallas Consolidated Street Railway, for \$850,000.

The North Dallas Electric Ry., it is announced, will shortly lay a double track.

The Dallas Consolidated Traction Co. contemplate substituting electric for animal traction on its Ervay and College Street lines.

**Ft. Worth**—The contract for the construction of the Park Street railway, we are informed, has been awarded the road to use the electric system.

The bids have been let for the construction of the Sylvania Street railway.

**San Antonio**—The San Antonio Street Railway company has petitioned for additional right of way through the city.

The San Antonio Street Railway company has purchased the lines and franchises and right of way of the Lake View Street Car company and the Prospect Hill railway.

**Waco**—The Citizens' Street Railway has been sold to St. Louis capitalists, for \$200,000. The new company will expend \$75,000 in improving its road.

Work for preparing the Citizens' Street Railway track for electric motor use, is being vigorously pushed forward.

## UTAH.

**Salt Lake City**—Work on the West Side Rapid Transit Line is moving forward with dispatch.

## WASHINGTON.

**Seattle**—The Seattle Electric Road, it is said, contemplates considerable double tracking and rebuilding.

The Yesler Avenue and Jackson Street Cable Railroad has been sold to J. M. Thompson, for about \$500,000. The road will be greatly improved by the new management.

**Spokane Falls**—The Spokane Cable Railway company has under consideration the raising of its capital stock to \$500,000.

**Steilacoom**—Mr. T. O. Abbott, sole owner of the Tacoma & Steilacoom Electric Railway, is pushing work ahead as vigorously as possible. The grading contract has been let.

**Tacoma**—The contract for building the Tacoma & Steilacoom Electric railway has been let to Contractors Geiger & Zabriskie.

The contract for building an electric railroad for the Tacoma Railway Motor Co. has been awarded to Robert McIntyre.

**Walla Walla**—The Walla Walla Street Car company, we learn, is considering the substitution of either gas or electric motors for horses.

## WEST VIRGINIA.

**Benwood**—The Wheeling Electric company has asked permission to lay a double track on its line in this place.

## MANITOBA.

**Winnipeg**—It is reported the committee appointed for the purpose, will recommend the city council to grant an American syndicate privilege to build an electric railway in certain streets.

## WISCONSIN.

**Milwaukee**—It is reported that the Milwaukee & Cream City Street Railway will be entirely rebuilt by the Villiard syndicate.

It is reported that work on the Milwaukee & Whitefish Bay Railway company will commence at an early date.

**Oshkosh**—It is reported, that if Mr. W. G. Maxcey, a capitalist, succeeds in gaining control of the street railway, he will substitute electricity for horse traction, and otherwise improve the service.



## NEW ENTERPRISES.

## ALABAMA.

**Birmingham**—A company, with Judge A. C. Hawze as president and Maj. J. M. Crowder as superintendent, has been formed to build a dummy line to Oxmoor. The contract has been let; work to commence without delay.

## ARKANSAS.

**Little Rock**—The Little Rock & Argenta Railway company has petitioned for a franchise for a street railway here.

## CALIFORNIA.

**Alameda**—Mr. Theodore Meetz has petitioned for a franchise to operate the Oakland, Alameda & Piedmont Street Car Railroad along Buena Vista avenue.

**Los Angeles**—It is announced that H. C. Witmer has decided to build a double track street railway, without delay, from Spring to Yarnell streets on Second street, at an estimated cost of \$200,000.

**Oakland**—E. C. Sessions and associates propose to build a street railroad through Fruitvale. A franchise has been granted to John W. Coleman, G. W. McNear and William D. English to construct an electric street railway.

**Paso Robles**—John T. Dunn, T. Haveland and G. R. Adams have asked for a franchise to construct a local street railway line two miles long.

**San Jose**—Jacob Rich was granted permission to build a single track electric street railway.

## COLORADO.

**Boulder**—A project to build another street car line is on foot, backed by Denver capital.

**Denver**—The Peoples' Rapid Transit company has been incorporated by F. F. Raby, W. H. Goshen, W. B. Lowry, Thomas Ord and J. C. Woodbury, to establish and maintain a system of street cars. Capital, \$250,000.

**Salida**—It is said that the Edison Electric Light Co. contemplates the construction of an electric motor line to Poncha Springs.

## FLORIDA.

**Bartow**—A franchise has been granted to Dr. Huddleston and associates to build a street railway here.

## GEORGIA.

**Atlanta**—The Metropolitan Street Railway has been granted a franchise for its projected road.

**Augusta**—I. T. Newbery and G. H. Nixon have petitioned the council for permission to build a street car line.

**Macon**—It is reported that Macon may boast of an electric railway ere long, an expert electrician having spent several days here looking into the cost, etc., of an electric line for the proposed new Metropolitan road.

## ILLINOIS.

**Belleville**—Mr. John L. Killmer has petitioned for a franchise to construct and operate an electric railway in Belleville.

**Dixon**—Thomas Higgins has made application for a franchise for a local road.

**Duquoin**—The Duquoin Street Railway Company has been incorporated by Henry Horn, P. N. Pope and P. D. Miflin.

**East St. Louis**—The Broadway & Dyke Street Railway company will build a local road if the franchise prayed for is granted.

**Freeport**—Harry Price and W. H. McCutchan have petitioned for the right of way for an electric street railway.

**Sterling**—The Fulton Street Car company has received a franchise for a road to be built within twelve months.

## INDIANA.

**Evansville**—The Peoples' Electric Street Railway company, capitalized at \$500,000, has been incorporated. A list of directors will be found under the head of elections.

**Indianapolis**—The Indianapolis & Broad Ripple Rapid Transit company, capitalized with \$100,000, has been incorporated, and Joseph Ferguson has been elected president and R. C. Light secretary.

The Franklin Street Railway has been incorporated by R. S. Overstreet, W. A. McNaugh-

ton, Daniel Mullindare and others; capital stock \$10,000.

**New Albany**—A stock company has been organized by Mr. John L. Statsenberg to build an electric street railway between this city and Jeffersonville with a capital stock of \$150,000.

**Richmond**—I. C. Shaffer, of Indianapolis, has contracted to construct an electric street railway to connect Earlham College with this place.

The Brookville, Richmond & Union City Railway has been incorporated, capitalized at \$60,000. The following gentlemen are interested: Joe Ramsey, Jr., B. S. Sutton, Isham Sedgwick, John F. Kibbey, John M. Gaar, James Smith, W. P. Hutton, George Knollenberg, E. G. Hill, C. E. Thompson, J. E. Morris, Charles A. Bishop and H. C. Kimble.

## IOWA.

**Sioux City**—The Leeds Electric Railway company has been incorporated by William Gordon, F. C. Henderson, D. T. Hedges and W. E. Higman; capital stock, \$250,000.

The Sioux City Street Railway company has received a franchise for its projected road.

## KANSAS.

**Junction City**—It is stated that the Junction City & Fort Riley Rapid Transit Street Railway company will construct several local roads at a very early date.

## KENTUCKY.

**Covington**—The Cincinnati, Covington & Rose-dale Electric Railway company has petitioned the common council for the right of way through this city.

## LOUISIANA.

**New Orleans**—E. H. Farrar, representing the Electric Traction & Manufacturing company, has purchased, at auction, from the municipal authorities, the franchise of the Felicity Street Car line for \$1,000. It is proposed to build it without delay.

## MARYLAND.

**Baltimore**—The North Avenue Electric Railway has received permission to build its road.

The Eckington Electric Street Railroad will commence its construction work without delay.

**Cumberland**—The Cumberland Electric Street Railway company has been incorporated by L. A. Fletcher, Thos. S. Kean, D. J. Duncan, Geo. D. Landwehr and James A. McHenry, and has received permission to build its projected road.

## MASSACHUSETTS.

**Attleboro**—A project to build another electric railway is under way, all the stock being subscribed.

**Nantucket**—The Nantucket Street Railway company has been incorporated with a capital stock of \$30,000, and work will begin soon on proposed road to the Cliff.

**Natick**—The Natick Street Railway company has received a franchise to build an electric street car line here.

**North Easton**—The building of an electric railway to connect with Brockton is now being agitated by local capitalists.

**Watertown**—The Hatherly Street Railway has been formed with a capital of \$10,000, to build a road to connect South Weymouth with Whitman.

## MICHIGAN.

**Detroit**—The Marquette & Presque Isle Street Railroad has been organized with a capital of \$25,000.

W. C. Robinson has applied for a thirty years' franchise to construct a street car line here.

Frank E. Kirby and others have petitioned the council for a franchise to build a street railroad.

**Green Bay**—Frederick Hurlbert has been granted an exclusive franchise for an electric street railway here.

**Kalamazoo**—The Kalamazoo City and County Street Railway has filed articles of incorporation; capital stock \$100,000.

**Owosso**—The Owosso Electric Railway has been incorporated with a capital of \$50,000.

**Wyandotte**—It is reported that the franchise for an electric railway to Detroit will soon be in shape to commence active operations.

## MISSOURI.

**Kansas City**—Henry Haines proposes to construct and operate an electric street railway, to be completed and ready for operation within twelve months.

The Oak Street Railway company has been

incorporated with a capital of \$50,000, motive power to be electricity. The following gentlemen have been elected directors: William B. Morehead, James A. Forbes and Perry C. Phillips.

**Springfield**—The Robberson Avenue Railway company has been incorporated with a capital of \$50,000, by F. S. Hefferman, M. J. Hubble and A. Hefferman.

## NEBRASKA.

**Beatrice**—The Beatrice Rapid Transit & Power Co. has been incorporated to build an electric street railway. The following named gentlemen are interested: N. N. Brumback, L. E. Spencer and G. M. Johnson.

**Omaha**—The Omaha & Southwestern Street Railway has petitioned for a franchise for electric, cable or other practicable roads in South Omaha and Omaha.

## NEW YORK.

**Lansingburg**—The Rapid Transit company of Troy has applied to the council for franchise to build a local tramway here.

**Lockport**—It is said that the Tonawanda Electric Railroad company will build a road from Buffalo city line to Tonawanda Creek.

**Middletown**—The Middletown Street Railway company has been granted a franchise for a local road.

**Troy**—The Troy Electric Street Railway company has been incorporated; capital stock \$20,000.

## OHIO.

**Ashtabula Harbor**—C. C. Curtis, of Cleveland, Ohio, has petitioned for a franchise for a local electric road.

**Cincinnati**—Charles T. McCrea petitioned for a franchise to build and operate a street railroad, an extension of the "bobtail" line on Hamilton pike.

**Cleveland**—The Collinswood & Cleveland Street Railway has been incorporated by T. K. Dissette, Morton W. Cope, William James, C. E. Morgenthaler and E. W. Dissette; capital stock \$25,000.

J. L. Athey, James W. Stewart and H. Clark Ford have petitioned for right to construct a double track street railway.

**Portage**—It is reported that an electric railway will shortly be built to connect Hiram Hill with Hiram Station of the Mahoning Branch.

**Springfield**—A project is on foot, headed by I. Ward Frey, to build a street railway here.

**Toledo**—The Ironville Street Railway company, with a capital stock of \$50,000, has been incorporated.

The Toledo Electric Street Railway has a franchise for a road on Summit Street from Adams to Perry.

H. S. Walbridge applied for permission to build and operate an electric street railway from city limits to Maumee.

**Zanesville**—The Zanesville Street Railroad company has been incorporated with a capital stock of \$200,000. The following gentlemen are interested: F. M. Townsend, T. B. Townsend, R. C. Burton, George W. Stewart and Robert McFaul.

## ONTARIO.

**Ottawa**—It is stated that it is highly probable that the projected electric street railway will be built by the Howland syndicate.

**Toronto**—The Weston, High Park & Toronto Street Railway company limited, has applied for incorporation with a capital stock of \$100,000. The board of directors elected are the following gentlemen: George Gurd, James Haverson, V. B. Wadsworth, J. S. McMurray, A. D. Perry and L. L. McMurray.

## OREGON.

**Freewater**—We understand that an electric motor line from here to Walla Walla will be constructed, a distance of ten miles.

## PENNSYLVANIA.

**Bethlehem**—The project for an electric street railway between this place and South Bethlehem is being agitated.

**Braddock**—The Braddock & McKeesport Electric Railway company has been incorporated, capitalized at \$100,000. A list of directors will be found under the head of Elections in the present issue.

**McKeesport**—The Dravosburg, Mendelssohn



& Elizabeth Street Railway company has been incorporated, capitalized at \$45,000, to build a road nearly eight miles long.

The Walnut Street Railway company has been organized with a capital of \$120,000. The following gentlemen are interested: William Flynn, J. W. Patterson, Mr. Mauer, W. C. Soles, R. T. Carothers. A list of the directors will be found under the head of Elections in the present issue.

**Pottsville**—The Schuylkill Electric Railway company have been granted a franchise to construct a local road here.

**Reading**—The City Passenger Railway company has received permission to build a branch road to Bechteltown.

**West Chester**—The West Chester Street Railway company has been incorporated, capitalized at \$30,000, and franchise has been granted to construct a local road.

#### SOUTH CAROLINA.

**Greenville**—A project is on foot to build a dummy line to Hotel Altamount on Paris Mountain, with a capital of \$100,000.

#### TENNESSEE.

**Johnson City**—A. M. Young has been granted a franchise for an electric street railway.

#### TEXAS.

**Dallas**—The plans and specifications of the proposed Ellen Street Cable Line having been accepted, work will commence without delay.

The Dallas Consolidated Traction Railway company has been incorporated with a capital of \$1,250,000. The board of directors consists of the following gentlemen: J. E. Schneider, R. A. Ferris, John N. Simpson, J. T. Trevezant, Alfred Davis, W. B. Kurtz, H. K. Fox and Nelson F. Evans.

**Fort Worth**—The Erath County Street Railway has been incorporated by A. Smith and others, with a capital stock of \$10,000.

**Waco**—The Waco Dummy line having secured its right of way, will lose no time in building its road.

#### UTAH TERRITORY.

**Ogden**—Revs. Sam Small and J. Wesley Hill have received a franchise for an electric street railway to new Methodist University grounds.

#### VERMONT.

**Windsor**—The Woodstock Railway company, capitalized at \$250,000, has been incorporated. The following gentlemen are interested: F. N. Billings, J. J. Dewey, F. S. McKenzie, Lewis Pratt, W. C. French and S. W. McCall.

#### VIRGINIA.

**Lynchburg**—The East Lynchburg & James River Development company, lately organized, has secured a franchise for a local street railway line.

**Richmond**—Warner Moore has petitioned for a franchise to build and operate an electric street railway.

**Roanoke**—The Union Land company has been incorporated with a capital of \$100,000 to operate street railways, etc.

#### WASHINGTON.

**Anacortes**—The Anacortes, La Connor & Mount Baker Electric Railway company has been organized with a capital stock of \$200,000.

**Ballard**—The town council has granted a franchise to the North End & West Electric Street Railway company for the construction of a local road.

**Seattle**—L. H. Griffith and W. C. Ralston have applied for a franchise for an electric motor road here.

The Metropolitan Electric Railway company has been incorporated by Jacob Furth, A. B. Stewart, J. M. Thompson, H. G. Struve, G. H. Heilbron, J. C. Haines, F. G. Grant, Bailey Gatzert, A. P. Mitten, J. P. Hoyt and Maurice McMickend. Capital stock \$3,000,000.

The Bellingham Bay Electric Street Railway company has been incorporated with a capital stock of \$200,000. A list of officers will be found under the head of Elections in the present issue.

**Walla Walla**—The Walla Walla Street Railway company, we understand, will build a motor line to Milton, a distance of twelve miles.

#### WISCONSIN.

**Milwaukee**—The Badger Street Railroad company has been incorporated to operate a road from Milwaukee through Wauwatosa and Greenfield.

## EXTENSIONS.

**San Francisco, Cal.**—The Geary Street Cable Co. has decided to extend its line.

**Denver, Col.**—The Consolidated Traction Street Railway Co. is laying a double track on its McKinney avenue extension. It is also surveying an extension to Belmont.

It is probable that the Denver Tramway company will extend its line to Manchester.

It is reported that the Agate avenue line will be extended to Sloan's Lake Park.

The South Broadway Electric line will shortly extend its lines one mile.

**Atlanta, Ga.**—The Metropolitan Street Railway has been granted permission to extend its lines.

It is stated that the Atlanta & Edgewood Railway company will extend its lines at an early day.

**Augusta, Ga.**—We learn that the Gwinnett Street Railway line will be extended.

**Macon, Ga.**—The Macon Electric Street Railroad will shortly extend its lines.

**Alton, Ill.**—Messrs. Holmes, Rogers, and McCluer, representing the Holmes Street Railroad syndicate, are negotiating for the purchase of the two street railroads between this town and Upper Alton, and also planning a new road to North Alton. They intend to run all three by electricity if they make the purchase.

**Rockford, Ill.**—We learn that the City Railway company has a large number of extensions to its lines in view.

**Lafayette, Ind.**—The street railway company, it is announced, will soon begin work on the West Lafayette extension.

**Des Moines, Iowa.**—It is stated that a survey has been made lately by the Electric Street Railway company for an extension of its line.

**Sioux City, Iowa.**—It is reported that the South Sioux City Street Railway contemplates several extensions of its line.

**Shreveport, La.**—It is reported that the City Street Railway will shortly extend its track beyond the city limits as well as locally.

**Boston, Mass.**—We understand that the Beverly & Danvers Street Railway will be extended in the near future.

**Duluth, Minn.**—It is reported that the electric line on Third street will be extended.

The Duluth Motor Line company will extend its line to Highland Park in the near future.

**Carthage, Mo.**—The Carthage Street Railway company, we learn, will extend its line two miles shortly.

**Kearney, Neb.**—We learn that the Kearney Motor line will at an early date extend its lines.

**Nashua, N. H.**—It is stated that the Nashua Horse Railroad company contemplates a great many extensions of its line in the near future.

**Sandy Hill, N. Y.**—The street railway, it is reported, will in the near future extend its line.

**Uica, N. Y.**—It is said that the Deerfield Street Railroad will extend its lines shortly.

**Akron, Ohio.**—The Akron Street Railway, it is stated, will be considerably extended in the near future.

**Cincinnati, Ohio.**—The Hamilton Pike Electric Railway, it is reported, contemplates several extensions of its line in the near future.

**Findlay, Ohio.**—The common council has granted a franchise to the Blanchard Avenue Street Railway to extend its lines.

**Toledo, Ohio.**—It is reported that the Consolidated Street Railway Co. will extend its lines.

**Youngstown, Ohio.**—The Youngstown Street Railway company has made application to extend its lines.

**Portland, Ore.**—The Portland Cable Railroad company has concluded to extend its road.

**Salem, Ore.**—It is announced that the Salem Street Railway has decided to extend its lines.

**Pottsville, Pa.**—It is reported that the Schuylkill Electric Railway company contemplates extending its lines in the near future.

**Reading, Pa.**—The City Passenger Railway company, it is reported, will shortly extend its lines.

**Charleston, S. C.**—The Charleston City Railway Co., it is announced, contemplates extending its line.

We are informed that the Enterprise Street Railroad Co. will shortly extend its line.

**Greenville, S. C.**—The Dunning Line company

has been awarded a franchise to extend its tracks.

**Chattanooga, Tenn.**—We understand that the street railway extension out Grove street will be commenced as early as practicable.

It is reported that work on the Missionary Ridge extension of the Chattanooga Electric Street Car company will be prosecuted without delay.

**Knoxville, Tenn.**—The Knoxville Street Railroad company has received permission to extend its tracks.

**Nashville, Tenn.**—It is announced that ground has been broken for the extension of the United Electric line.

**Galveston, Tex.**—It is highly probable that the Galveston City Railroad will extend its line to reach adjacent suburbs.

**Weathersford, Tex.**—The Weathersford Street and Suburban Railroad company contemplates the extension of its lines at an early date.

**Seattle, Wash.**—The Seattle Electric Railway, it is said, will extend its Cedar street line.

**Walla Walla, Wash.**—The Walla Walla Street Car company contemplates the extension of its lines at an early day.

**La Crosse, Wis.**—The La Crosse City Railway company has received permission to extend its line.

**Milwaukee, Wis.**—The Milwaukee City Railway company has received permission to extend its racks.

## ELECTIONS.

**Denver, Col.**—At a meeting of the People's Rapid Transit company the following Board of Directors was elected:—F. F. Rody, J. C. Woodbury, W. H. Goshen, Thomas Ord and Louis Aiken.

**Glastonbury, Conn.**—At a meeting of the East Hartford & Glastonbury Horse Railroad company, the following officers were elected:

President—P. Henry Goodrich.

Vice-Prest.—Isaac Brodhead.

Secy.—George D. Curtis.

Treasurer—P. Garvan.

**Hartford, Conn.**—At the annual meeting of the Hartford & Wethersfield Horse Railroad company, Henry Keeney, Roland Mather, James J. Goodwin, Charles L. Lincoln, Daniel R. Howe, Atwood Collins, Samuel B. Dunham and E. S. Goodrich were elected directors.

**East St. Louis, Ill.**—The Broadway & Dyke Street Ry. company, at a meeting, elected a Board of Directors, consisting of Fred Heinze, John O. Butler, Benjamin Sikking, O. C. Kresse, J. A. Horn, C. L. Walrath and M. Millard.

**Evansville, Ind.**—The first Board of Directors of the People's Electric Street Railway company is as follows:—David J. Mackey, Wm. Heilman, Lee Howell, Fred W. Cook and William J. Wood.

**Sioux City, Iowa.**—At a meeting of the Leeds Electric Railway company, the following gentlemen were elected as directors—D. T. Hedges, William Gordon, C. B. Oldfield, John Peirce, C. H. Hammett, W. E. Higman and F. C. Henderson.

**Cumberland, Md.**—At a meeting of the Cumberland Electric Street Railway company, the following gentlemen were elected directors:—Lawrence Fletcher, George D. Landwehr, Thomas S. Kean, James A. McHenry and David J. Duncan.

**Nantucket, Mass.**—At a meeting of the Nantucket Street Railway company, the following gentlemen were elected as directors:—George C. Scofield, Harry O. Reed, T. C. Macy, R. B. Hussey, H. S. Ayer, George C. Pratt and John Harps.

At the first meeting of the Nantucket Beach Street Railway, the following gentlemen were elected as officers for the ensuing year:

President—Henry Pratt.

Treasurer—John F. Simmons.

Clerk—Thomas G. May.

**Springfield, Mass.**—The following named gentlemen constitute the Board of Directors of the Pittsfield Electric Street Railway company:—W. R. Plunkett, J. W. Hull, Alexander Kennedy, James Bacon, C. E. Merrill, Judge Joseph Tucker and Col. Walter Cutting.

**Alpena, Mich.**—At the first meeting of the Al-



pena City Railway company, the following named gentlemen were elected as officers:

- President—E. O. Avery.
- Vice-Pres.—John Monaghan.
- Secy.—C. E. Williams.
- Treasurer—B. C. Morse.

**Detroit, Mich.**—At the first meeting of the Marquette & Presque Isle Street Railroad, the following officers and directors were elected:

- President—F. O. Clark.
- Vice-Pres.—Timothy Nestor.
- Treasurer—James Connolly.
- Secy.—M. E. Asire.
- Directors—George W. Hager and J. A. Vanier.

**St. Paul, Minn.**—At a meeting of the Judson Pneumatic Street Railway company, the following gentlemen were elected directors:—W. L. Judson, H. D. Cooke, W. W. Dudley, Louis Walker, H. L. Earle, James F. Williamson and C. E. Pendleton.

**Kansas City, Mo.**—At the annual election of directors of the Kansas City, Independence and Rapid Transit Railway, the following gentlemen were chosen:—Walton Holmes, Conway F. Holmes, Charles L. Hutchinson, Earnest A. Hammill, D. B. Holmes, W. A. Bunker and W. B. Clarke.

**St. Joseph, Mo.**—A re-organization of the Union Street Railway company made lately, resulted in the following election of officers:

- President—William B. Dowd.
- Sec. and Treasurer—J. H. Van Brunt.
- Directors—John Donovan, jr., T. H. Beekman, W. K. Anuck, John Townsend, J. H. Van Brunt, W. B. Dowd and Charles S. Boyd.

**Amsterdam, N. Y.**—At a meeting of the Amsterdam Electric Railroad company, the following officers were chosen:

- President—F. H. Johnson.
- Vice-Pres.—I. H. McClements.
- Treasurer—David Cady.
- Secretary—Martin L. Stover.

**Tonawanda, N. Y.**—At a meeting of the Tonawanda Electric Railway company, the following gentlemen were elected trustees:—J. C. Conway, E. H. Butler and Michael Nellaney.

**Troy, N. Y.**—At a meeting of the Rapid Transit Railway company, the following gentlemen were elected directors:—Daniel E. Conway, John Flynn, Charles L. McArthur, David Morey, Peter H. Buckley, Thomas Dickson, Michael F. Collins, James E. Ryan, Edward F. Murray, James K. Pine and Clarence N. Flack.

**McKeesport, Pa.**—At a meeting of the Dravosburg, Mendelssohn & Elizabeth Street Railway, the following officers were elected:

- President—James E. White.
- Vice-Pres.—J. R. Mahoney.
- Secretary and Solicitor—H. H. Swaney.
- Directors—James E. White, John Haben, John K. Skelley, James L. Devenny and Joseph A. Skelley.

At a meeting of the Walnut Street Railway company, the following gentlemen were elected as officers and directors:

- President—W. C. Soles.
- Secretary and Treasurer—M. Mauer.
- Directors—R. T. Carothers and Alonzo Inskeep.

**Memphis, Tenn.**—The following gentlemen, interested in the new street-car system, comprise the present Board of Directors:—C. B. Holmes, of Chicago, John R. Goodwin, F. E. Hinkle, R. Semmes and Luke E. Wright, of Memphis, and James L. Blair, of St. Louis, Mo.

At a subsequent meeting the following officers were elected:

- President—C. B. Holmes.
- Vice-Pres.—G. W. Parke.
- Sec. and Gen'l Manager—R. Semmes.
- Attorney—Luke E. Wright.

**Weatherford, Texas**—At a late meeting the Weatherford Street & Suburban Railway company elected the following officers and directors:

- President—George P. Levy.
- Vice-Pres.—T. R. Stone.
- Sec. and Treasurer—James P. Owens.
- Supt.—George B. Wilbanks.
- Directors—Henry Warren, A. Applegate, W. B. Altfather, J. P. Owens, George P. Levy, T. R. Stone and George D. Wilbanks.

**Seattle, Washington**—At a recent election of the Bellingham Bay Electric Street Railway

company, the following gentlemen were elected:

- President—Eugene Canfield.
- Vice-Pres.—P. B. Cornwall.
- Secretary—C. W. Dorr.
- Treasurer—J. W. Morgan.
- Superintendent—C. D. McKellar.

The Kirkland Investment company, capitalized at \$120,000, has been incorporated to build street-car lines, etc. The following gentlemen have been elected as directors:—A. B. Stewart, Jacob Furth, A. P. Mitten, Jasper Compton, Peter Kirk, Bailey Gatzert, H. E. Holmes, L. S. J. Hunt, H. G. Struve, Maurice McMicken, E. J. Grant and W. Olds.

**Patents.**

The following is a complete list of such patents as relate to street railway interests, issued between July 15 and Aug. 5, especially prepared for the STREET RAILWAY GAZETTE by Messrs. Higdon & Higdon, solicitors of patents and trade marks, room 36, LeDroit building, opposite U. S. Patent Office, Washington, D. C. A printed copy of any patent here named will be furnished by them for 25 cents (stamps).

*Issue of August 5, 1890.*

- 433,611. Trolley for Electric Motor Cars, Force Bain, Chicago, Ill.
- 433,523. Commutator for Dynamos, P. M. Smith, Plainfield, N. J., and W. D. Perry, Brooklyn, N. Y.
- 433,858. Street or Station Indicator for Railway Cars, John R. Fletcher, Baltimore, Md.
- 433,903. Electric Motor Mechanism, H. G. Thompson & Sons, New Haven, Conn.
- 433,904. Electric Motor Mechanism, H. G. Thompson & Sons, New Haven, Conn.
- 433,544. Electric Railway, Abraham A. Shobe and W. Embley, Jerseyville, Ill.
- 433,547. Street Railway Switching Device, Roswell T. Smith, Nashua, N. H.
- 433,548. Street Railway Switching Device, Roswell T. Smith, Nashua, N. H.
- 433,605. Street Indicator for Street Cars, George J. Spoelstra, Vandermeer, and G. Stevens, Grand Rapids, Mich.
- 433,667. Alarm for use on Cable Railways, Charles M. E. Wendnagel, Chicago, Ill.
- 433,754. Motor Support for Railway Cars, William Wharton Jr., Philadelphia, Pa.
- 433,839. Trolley for Electric Street Cars, Franklin C. Wheeler, assignor of one-half to H. Corbett, St. Joseph, Mo.
- 433,918. Electric Railway Conduit System, Wheelless Electric Railway Company, Alexandria, Va.
- 433,843. Cable Grip, Frank A. Yard, assignor of one-half to More, Jones & Co., St. Louis, Mo.

*Issue of July 15, 1890.*

- 432,208. Electric Motor Car, James F. McLaughlin, Philadelphia, Pa.
- 432,424. Folding Step for Vehicles, William A. Miller, Springdale, Ark.
- 432,063. Trolley, William C. Miller, Albany, N. Y.
- 432,169. Dynamo-Electric Machine, Frank A. Perret, Brooklyn, N. Y.
- 432,086. Metallic Car, Charles T. Schoen, Philadelphia, Pa.
- 432,095. Electric Railway Switch, William D. Swart, Boston, Mass.
- 432,500. Armature, Edmund Wagemann, assignor of six-sevenths to J. D. and D. Adams, O. and J. W. Davis, H. G. Allis and J. B. Jones, Little Rock, Ark.
- 432,501. Electric Car, Edmund Wagemann, assignor of six-sevenths to J. D. and D. Adams, O. and J. W. Davis, H. G. Allis and J. B. Jones, Little Rock, Ark.

*Issue of July 22, 1890.*

- 432,927. Automatic Lubricating Device for Electric Motors, Samuel L. Barriett, Brooklyn, N. Y.
- 432,816. Splice for Railway Rails and Other Bars, James M. Bryant, C. H. Zimmerman and J. Becker, assignors to said Zimmerman and Becker, J. Bryant and B. F. Peabody, Benwood, W. Va.
- 432,748. Armature for Dynamo-Electric Machines, Nathan H. Edgerton, Philadelphia, Pa.

- 432,730. Cable Railway Construction, George F. Gray, San Francisco, Cal.
- 432,707. Electric Motor, Henry Humbert, Brooklyn, N. Y.
- 432,623. Electric Railway, Rudolph M. Hunter, Philadelphia, Pa.
- 432,752. Electric Railway, Rudolph M. Hunter, Philadelphia, Pa., assignor to Thomson-Houston Electric Company of Connecticut.
- 432,753. Electric Railway, Rudolph M. Hunter, Philadelphia, Pa., assignor to Thomson-Houston Electric Company of Connecticut.
- 432,670. Conduit Electric Railway, Byron Jennings, San Jose, Cal.
- 432,944. Conduit Electric Railway, Byron Jennings, San Jose, Cal.
- 432,673. Electric Railway, Frank Mansfield, Melrose, Mass.
- 432,674. Electric Railway, Frank Mansfield, New York, N. Y.
- 432,675. Electrical Railway, Frank Mansfield, New York, N. Y.
- 432,757. Cable Railway, Alexander H. Matheusius, Brooklyn, N. Y.
- 432,561. Brush Reverser for Electric Motors Anthony Reckenzaun, London, England, assignor to Electric Car Company of America, Philadelphia, Pa.
- 432,908. Car Starter, Louis C. Seebach, George and L. Bush, Listowel, Ontario.
- 432,571. Conduit System for Electric Railways, Nicholas Seibert, Malden, Mass.
- 432,954. Street Railway Car, Edward C. Sessions, Oakland, Cal.
- 432,557. Dynamo-Electric Machine, Henry W. Spang, New York, N. Y.
- 432,655. Dynamo-Electric Machine, Elihu Thomson, Lynn, Mass.

*Issue of July 29, 1890.*

- 433,390. Brush Holder for Electrical Machines, Warren S. Belding, Englewood, Ill.
- 433,391. Armature for Dynamos, etc., Warren S. Belding, Englewood, Ill.
- 433,392. Blank for Armature Coil Guards, Warren S. Belding, Englewood, Ill.
- 433,393. Commutator for Dynamos, Warren S. Belding, Chicago, Ill.
- 433,394. Power-Transmitting Mechanism, Warren S. Belding, Chicago, Ill.
- 433,269. Regulator for Dynamo-Electric Machines, Perley P. Belt, Fredonia, Kan.
- 433,400. Magnetic Coupling Device, Theodore M. Foote, Boston, Mass.
- 433,401. Variable Speed Gearing for Electric Cars, Theodore M. Foote, Boston, Mass.
- 433,402. Reversing Gear for Electric Cars, Theodore M. Foote, Boston, Mass.
- 433,237. Street Railway Switch, Cabel E. Garey, assignor to W. White, New York, N. Y.
- 433,123. Cable Grip, Elias R. Guerra, Hacienda de San Matias, Jalisco, Mexico.
- 433,170. Electric Railway, Rudolph M. Hunter, Philadelphia, Pa., assignor to Electric Car Company of America.
- 433,407. Electric Railway, Rudolph M. Hunter, Philadelphia, Pa., assignor to Thomson-Houston Electric Company of Connecticut.
- 433,408. Electric Railway, Rudolph M. Hunter, Philadelphia, Pa., assignor to Thomson-Houston Electric Company of Connecticut.
- 433,205. Street or Station Indicator, Alfred Jones and W. Seaver, St. Louis, Mo.
- 433,409. Electric Railway, Herbert R. Keithley, Denver, Col.
- 433,180. Electric Motor Traction Wheel, Albert L. Parcelle, Boston, Mass., assignor to Florence Motor Company of Maine.
- 433,181. System of Electrical Transportation, Albert L. Parcelle, Boston, Mass., assignor to Florence Motor Company of Maine.
- 433,051. Dynamo-Electric Machine, Henry W. Spang, New York, N. Y.

FOR SALE.—A number of valuable patents relating to Street and Steam Railways. Address K, Care of THE STREET RAILWAY GAZETTE.

**STREET RAILWAY PROPERTY FOR SALE.**

The property of the Hastings Improvement Company, of Hastings, Neb., consisting of eleven miles of track, fully equipped, with franchise allowing the use of horses, cables, or electricity as a motive power. Address, HAYDEN, Care STREET RAILWAY GAZETTE.



Electric Street Railways in North America.

IN OPERATION OR UNDER CONTRACT SEPTEMBER 1, 1890.

Table with columns: OPERATING CO., LOCATION, SYSTEM, CARS, MILES. The table lists various electric street railway systems across North America, including companies like Adrian Electric Ry. Co., Akron Electric Ry. Co., and others, along with their respective locations and operational details.



# The Street Railway Gazette.

(Copyrighted, 1890.)

Vol. V.

CHICAGO.

OCTOBER, 1890.

CHICAGO.

No. 10

## Col. HENRY M. WATSON.

PRESIDENT, AMERICAN ST. RY. ASSOCIATION.

In its issue of April, 1889, the STREET RAILWAY GAZETTE in publishing the history of the Buffalo St. Ry. Co., from its inception also published a picture of its President, Col. H. M. Watson, and concluded the article in the following language: "Without a doubt he could have been president of the A. S. R. A. as far back as the St. Louis Convention (1885), but for reasons best known to himself, he has thus far discouraged all action pertaining to his election to that important office. Unless however indications count for nothing, it would not surprise us to see Col. Watson wielding the gavel of the A. S. R. A. in the near future, and should he do so the honor thus conferred upon him will certainly have been well earned." That the prediction of the GAZETTE made over a year and a half ago has been amply verified, the election of Col. Watson to the presidency of the Association, this Convention of 1890, goes to substantiate, and it gives us more than ordinary pleasure to publish for the second time a facsimile of the features of this well known and popular gentleman.

Col. Watson was one of the plucky few who responded to Mr. Littell's call for a Convention, and was present at the first meeting held in Boston in 1882, and from that time down to the present has only missed an attendance at one Convention, viz: that held in Washington, when a most serious attack of peritonitis prostrated him at the Massachusetts General Hospital in Boston.

Col. Watson is a native of Otsego County, New York State, and first became officially identified with the interests of the Buffalo St. Ry. Co., in 1863, when he succeeded Secretary Coit in his official position; and upon the death of his distinguished father, Mr. S. V. R. Watson, the controlling interest of the company passed into his hands; he was elected to its presidency in the month of June, 1881.

Besides his intimate connection with street railway interests Col. Watson is also president of the Bell Telephone Company of Buffalo, and Director of the Union Fire Ins. Co., and of the Farmers and Mechanics Bank of Buffalo, and a Trustee of the Erie County Savings Bank of the same city. He was on the staff of Gov. Alonzo B. Cornell during that gentleman's term of office as Governor of the State of New York, and, through his connection therewith, attained the rank of Colonel.

During the past year Col. Watson has been elected to the presidency of the East Buffalo St. Ry. Co., which office he holds without prejudice to his interests in the Buffalo St. Ry. Co.

Those who know Col. Watson, know also his great goodness of heart and universal geniality; while to those who do not know him, we will say that he is a typical New York business man, a firm friend, and a thorough gentleman.

## AMERICAN Street Railway Association.

### Ninth Annual Meeting.

The ninth annual meeting of the American Street Railway Association was held at the Iroquois Hotel, Buffalo, N. Y., beginning October 15th, 1890.

The following members' delegates were present: Atlanta, Ga.—W. S. Larendon, Superintendent; Atlanta Street Railway Co. Baltimore, Md.—Wm. A. House, Jr., General Manager; Baltimore Traction Co. Birmingham, Conn.—H. Holton Wood, President; Derby Horse Railway Co.



COL HENRY M. WATSON.  
President American Street Railway Association.

Boston, Mass.—Edmond Reardon, Vice-president; F. H. Monks, General Manager; Louis Püfngst, Master Mechanic; West End Street Railway Co. Boston, Mass.—A. F. Breed, President, E. C. Foster, Superintendent; Lynn & Boston Railroad Co. Bridgeport, Conn.—B. F. Lasher, Superintendent; Bridgeport Horse Railway Co. Brockton, Mass.—Wm. M. Cross, President, H. B. Rogers, General Manager; Brockton Street Railway Co. Brooklyn, N. Y.—Wm. Richardson, President, W. J. Richardson, Secretary; Atlantic Avenue Railway Co. Andrew R. Murphy, Trackmaster; Wm. N. Morrison, Superintendent of Horses, Brooklyn City Railway Co. Buffalo, N. Y.—S. S. Spaulding, President; H. M. Watson, Treasurer; Buffalo East Side Street Railway Co. H. M. Watson, President; S. S. Spaulding, Secretary; Buffalo Street Railway Co. Canton, Ohio.—F. A. Seiberling, Treasurer, W. D. Chapman, Engineer, Canton Street Railway Co. Camden, N. J.—Wm. S. Seull, President; Morris W. Hall, Secretary; G. G. Browning, Treasurer; Camden Horse Railway Co.

Chicago, Ill.—H. H. Windsor, Secretary; T. C. Pennington, Treasurer; Chicago City Railway Co. Cincinnati, O.—J. A. Collins, Secretary; John Harris, Superintendent; Cincinnati Street Railway Co. Jos. Thoms, Director; Mount Adams' Inclined Plane Railway Co. H. M. Littell, President, Cincinnati Inclined Plane Railway Co., and Henry Martin, President, Mt. Auburn Cable Railway Co. Cleveland, O.—J. J. Stanley and Horace Andrews, of the Broadway & Newburg R. R. Co. President, Chas. W. Watson, Electrical Engineer, and H. A. Everett, Secretary, East Cleveland Railroad Co. Covington, Ky.—G. M. Abbott, Treasurer; Geo. Bullock; S. Covington & Cincinnati Street Railway Co. Davenport, Iowa—Wm. L. Allen, President; Davenport Central Railway Co. Detroit, Mich.—Jas. N. Vhay, Secretary; N. W. Goodwin, Secretary; Fort Wayne & Elwood Railway Co. Dover, N. H.—H. W. Burgett, Vice President; Union Street Railway Co. Easton, Pa.—H. A. Sage, President; Easton, South Easton & West End Railway Co. Fall River, Mass.—Robert E. Goff, Secretary, Globe Street Railway Co. Findlay, O.—Chas. Smith, Superintendent; Findlay Street Railway Co. Galveston, Tex.—Wm. H. Sinclair, President; Galveston City Railway Co. Hamilton, Ont.—B. E. Carlton, President; T. B. Griffith, Secretary and Treasurer; J. B. Griffith; Hamilton Street Railway Co. Harrisburg, Pa.—H. A. Kelker, President; A. Roberts, Secretary; Harrisburg City Passenger Railway Co. Hartford, Conn.—E. S. Goodrich, President; Hartford & Wethersfield Railway Co. Indianapolis, Ind.—J. C. Shaffer, President; Citizens Street Railway Co. Kansas City, Mo.—R. J. McCarthy, General Manager; Metropolitan Street Railway Co. Lafayette, Ind.—G. E. C. Johnson, President; R. J. Hawver, Superintendent; Lafayette Street Railway Co. Lincoln, Neb.—E. L. Woolley, Superintendent; Lincoln Street Railway Co. Little Rock, Ark.—H. B. Bradford, Secretary; J. M. Gaylor, Director; Little Rock & Citizen's Street Railway Co. London, Can.—V. Cronyn, President; T. H. Smallman, Director; London Street Railway Co. Louisville, Ky.—H. H. Littell, General Manager, Louisville Railway Co. Lowell Mass.—E. M. Tucker, President, E. J. Noyes, Superintendent, and Frank N. Howe, Director, Lowell Horse Railroad Co. Manchester, N. H.—C. Williams, President; N. H. Walker, Superintendent; Manchester Street Railway Co. Memphis, Tenn.—R. Semmes, of the Citizens Street Railway Co. Minneapolis, Minn.—Thomas Lowry, President; Minneapolis Street Railway Co. Nashua, N. H.—George H. Knowles, President, and Chas. Williams, Director, Nashua Street Railway Co. Newark, N. J.—Thomas C. Barr, President; Newark Passenger Railway Co. Newburyport, Mass.—C. Odell, President; J. K. Kerr, Substitute; T. H. Johnson and R. R. Brown, Directors; Newburyport & Amesbury Horse Railroad Co. New York City, N. Y.—Wm. Richardson, Director; Dry Dock, East Broadway & Battery Railway Co. G. Green, President; J. M. Calhoun, Superintendent; 42nd Street & Grand Street Ferry Railway Co. W. H. Delaney, President; R. Avery, Director; North & East River Railroad Co. T. H. McLean, Secretary; 23rd Street Railway Co. D. B. Hasbrouck, Vice-President Houston, West Street and Pavonia



Ferry Railroad Co. C. Densmore Wyman, Vice President, and J. N. Valentine, Secretary, Central Park, North and East River Railroad Co.  
 Niagara Falls, N. Y.—C. B. Gaskill, President; C. B. Hill, Secretary; G. B. Johnson, Superintendent; B. H. Johnson, A. Mevot and A. J. Porter, Directors; Niagara Falls & Suspension Bridge Railway Co.  
 Omaha, Neb.—W. A. Smith, General Manager, Omaha Street Railway Co.  
 Orange, N. J.—F. M. Eppley, President; Orange Cross-town & Bloomfield Street Railway Co.  
 Ottawa, Can.—T. C. Keefer, President; Ottawa City Passenger Railway Co.  
 Peoria, Ill.—H. R. Woodward, Vice-President and General Manager of the Central Railway Co.  
 Philadelphia, Pa.—E. B. Murphy, President; Lombard & South Street Passenger Railway Co. E. B. Murphy, President; Peoples Passenger Railway Co.  
 Pittsburgh, Pa.—J. B. Holmes, President; J. C. Rugg Superintendent; Citizens Traction Co. D. F. Henry, President; W. M. Ramsey, Electric Superintendent; Federal Street & Pleasant Valley Passenger Railway Co.  
 Providence, R. I.—M. H. Bronsdon, Superintendent; Providence Cable Tramway Co. A. T. Potter, General Manager; H. V. A. Joslin, Secretary; Union Railroad Co.  
 Reading, Pa.—B. F. Owen, President; Reading City Passenger Railway Co.  
 Rochester, N. Y.—A. G. Yates, President; J. N. Beckley, Vice-President; A. Luetichford, Treasurer; M. A. Verner, General Manager; S. McKee and Fred. Cook, Directors; Rochester Railway Co.  
 Salt Lake City, Utah—Walter P. Reed, Superintendent, Salt Lake City Railroad Co.  
 Sandusky, Ohio—C. Rude, Superintendent; Sandusky Street Railway Co.  
 Savannah, Ga.—Henry Parsons, Engineer, and George Parsons, Director, City and Suburban Railway Co.  
 Sioux City, Iowa—J. F. Peavey, President; Sioux City Street Railway Co. C. W. Hornick, President, Riverside Park Railway Co.  
 Springfield, Mass.—A. E. Smith, Treasurer; Springfield Street Railway Co.  
 St. Louis, Mo.—Chas. Green, President; Peoples Railway Co.  
 St. Paul, Minn.—Thomas Lowry, President; St. Paul City Railway Co.  
 Taunton, Mass.—George C. Morse, Superintendent, Taunton Street Railway Co.  
 Terre Haute, Ind.—R. W. Rippetoe, President, and Leslie D. Thomas, Secretary, Terre Haute Street Railway Co.  
 Toledo, Ohio—A. E. Laog, President; D. E. Bailey; Toledo Consolidated Street Railway Co.  
 Topeka, Kansas—C. S. Glead, President; E. H. Littlefield, Superintendent; Topeka City Railway Co.  
 Toronto, Can.—J. Gunn, Secretary; G. W. Kiely, Managing Director; G. F. Shipley, Solicitor; Toronto Street Railway Co.  
 Trenton, N. J.—C. Y. Bamford, Treasurer; A. L. Worthington, Director; City Railway Co. L. Perrine, Jr., President; W. S. Gulick, Assistant Superintendent; Trenton Horse Railroad Co.  
 Troy, N. Y.—Chas. Clemenshaw, President, and Chas. H. Smith, Superintendent, of the Troy & Lansingburg R. R. Co.  
 Washington, D. C.—Wm. Dunlap and C. C. Sailor, Superintendent of the Washington & Georgetown Railroad Co. George W. Pearson, President and Robert Beale, Director of the Metropolitan Railroad Co., and J. Stephenson, President, and R. F. Baker, Secretary and Treasurer, of the Columbia Railway Co.  
 West Haven, Conn.—I. A. Kelsey, President; S. A. Stevens, Secretary; New Haven & West Avenue Horse Railway Co.  
 Wilmington, Del.—E. W. Heald, General Manager; Wilmington City Railway Co.  
 Worcester, Mass.—C. B. Pratt, President; H. S. Seeley, Secretary; Worcester Consolidated Railway Co.  
 York, Pa.—W. H. Lanus, President; D. K. Trimmer, Secretary; F. Guise, Treasurer; D. A. Rupp, Stockholder; York Street Railway Co.

Of the roads which were not members of the Association, the following were represented by the gentlemen named:

Alton, Ill., Alton Improvement Association, H. R. Kinney, Secretary.  
 Asheville, N. C., Asheville Street Railway Co., B. M. Jones, Secretary and Treasurer.  
 Attleboro, Mass., Winthrop Collin, President, Attleboro Street Railway Company.  
 Baltimore, Md., J. M. Blondell, Supt. Car Shops, City Railway Co.  
 Boston, Mass., Boston and Revere Electric Railway Co., W. G. Benedict, President; N. M. Jewett, Director.  
 Decatur, Ill., Citizens' Electric Street Railway Co., Wm. L. Ferguson, Superintendent.  
 Erie, Pa., Erie Passenger Railway Co., J. F. Pfeteh, General Manager.  
 Evansville, Ind., A. G. Hathaway, Director, Evansville Railroad Co.  
 Fort Scott, Kan., Fort Scott Rapid Transit Railway Co., A. L. Hughes, Treasurer.  
 Fort Worth, Tex., North Side Railway Co., George B. Hendricks, Secretary.  
 Joliet, Ill., Joliet Street Railway Co., John Hulsizer, Secretary.  
 Lancaster, Pa., J. E. Aekley, Secretary, and Knight Nefel, Superintendent, Lancaster City Street Railway Co.

Lawrence, Mass., Merrimac Valley Railway Co., W. B. Ferguson, President; John Munningham, Director.  
 Newton, Mass., George W. Morse, President, Newton Street Railway Co.  
 Oswego, N. Y., Oswego Street Railway Co., Francis J. Callanan, President.  
 Piqua, O., Piqua Street Railway Co., F. C. Davies, Secretary.  
 Plymouth, Mass., Plymouth and Kingston Street Railway Co., C. E. Barnes, Superintendent.  
 Pottsville, Pa., People's Railway Co., Wm. D. Barber.  
 Richmond, Ind., Richmond City Street Railway Co., Wm. H. Shaffer, General Manager.  
 Salem, Oregon, Capital City Railway Co., P. S. Knight, President.  
 St. Joseph, Mo., Wyatt Park Railway Co., W. J. Hobson, President.  
 Wheeling, W. Va., Citizens' Railway Co., J. A. Miller, President; M. Loftus, Superintendent; John M. Sweeney, Director. Wheeling Railway Co., John M. Sweeney, President; M. Loftus, Superintendent.

#### PRESIDENT'S ADDRESS.

*Gentlemen of the Convention*:—I am pleased to meet you in this beautiful City of Buffalo, assembled in the Ninth Annual Convention of the American Street Railway Association.

I congratulate you upon the progress made, and past good work of the Association. When organized in 1892, in the City of Boston, street railroading was in its infancy, but such rapid advancement has since been made in city passenger traffic that the United States Government has deemed it of sufficient importance to incorporate in its Census Statistics, for 1890, a report on Street Railways in cities of over 50,000 inhabitants. In this report 56 cities are included, and out of a total of 3,150 miles of track in these cities,

2,351 miles are operated by horses,  
 260 miles by electricity,  
 255 miles by cable,  
 221 miles by steam.

and the balance, about 60 miles, being the elevated roads in New York and Brooklyn. This report would seem to indicate that in the larger cities the faithful old horse is still the favorite propelling power for street cars.

The first special subject on which we are to receive a report from a committee appointed at the last Convention, is "A perfect Street Railway Horse." From this we must assume that the Association has not yet discarded the idea that the horse is the most reliable power for street cars.

In the smaller cities electricity is generally being adopted, and I am informed that there are already in operation in cities and towns outside of those enumerated in the Census Report, about 1,690 miles of Electric Street Railways. I am so thoroughly convinced that electricity is the coming power for Street Railways (except on heavy grades where the cable is best suited), and that it will prove so effective, as a means of rapid transit for cities, that I believe that this is the last Convention that will ever seriously consider horses for the operation of street railways.

Rapid transit in growing cities is becoming a necessity. While municipal corporations in the larger cities, for many reasons, are slow to grant new privileges to corporations, and in the case of electricity they are very closely scanned and criticised, it will soon become self evident that a municipal body can grant no greater boon to its middle and laboring classes than to provide them with the means of rapid and cheap transportation to and from homes in the suburbs, where they can live under a clear sky and in a health-giving atmosphere. When the people of a city understand clearly the great benefits of rapid transit, by electricity or other improved motive power over horses, they will demand that their city authorities grant such rights as will enable street railway companies to operate by the most improved methods.

Heretofore Street Railway Securities have not been looked upon by the financial world with favor. However, since they have been so successfully operated by electricity the financial men of the country are looking to its development and application to street railways as an additional reliable security for the investment of Savings and Trust funds. This should give encouragement to street railway companies to give their various cities the most improved and best possible service. They will not only please their patrons but the investment will prove very profitable. If street railway companies do this, no better security can be offered for the savings of the widow and orphan than a good street railway bond in a thriving city.

In order to bring this about, municipal corporations should grant liberal franchises for street railway improvement. The bond of the street railway company should be as good as the bond of the city in which it is located. The growth of the city is, to a large extent, dependent on street railway extensions, and the prosperity of the street railway company means the prosperity of the city in which it is located. It is one of the largest factors in the development of any city and as necessary as are its schools and its churches.

On the other hand, the street railway company should be required to equip its road with the finest and most modern cars, construct the best and most substantial tracks so as to inconvenience the public as little as possible in making repairs, and in short supply the road in every department with the best and most modern appliances of all kinds.

In view of the agitation of the labor question, it may not be out of place for me to say a word on that subject. In so doing it will only be the expression of an individual opinion, not intended to bind the Convention to the

views expressed. When organizations are formed by laborers and others for the purpose of building up and dignifying its members as men and women, or to improve their moral, physical or financial condition, no one would foster or favor them more than he who now addresses you. Unfortunately, however, most of the present so-called labor organizations are the worst delusion and snare into which a laboring man was ever entrapped. The recent "strike" on the New York Central Road developed a state of cruelty, depravity and wrong that should make it the absolute duty of every corporation, having public interests to subserve, and charged with providing for the comfort, convenience, business necessities, and above all the life and property of its patrons, to refuse to employ or retain in its employ any one who does not renounce his "connection with the "Knights of Labor" or any other labor organization, the rules of which permit employees of a corporation to be "ordered to strike." Men have a right to quit work with such notice as the contract with their employers requires, either singly or in a body, if the terms of their employment are not satisfactory; but they have not the right to interfere with those employed to supply their places. The first duty of a lawyer is to his client, of a doctor to his patient, a minister to his congregation and a teacher to his pupil. The engineer, the conductor, the switchman have even a greater responsibility, as the lives of the passengers are in their keeping, and in order to properly discharge it, they must be loyal to their employers. They cannot be plotting and laying out rules for their employer and be faithful in the discharge of their duty. "The laborer is worthy of his hire," but when he seeks to change the relation between himself and his employer, by asserting himself as master, he ceases to be the laborer that is "worthy of his hire." He also unfit himself for any kind of advancement. A man, to be successful and take advantage of promotion earned by efficiency, must be contented and perform his work cheerfully. A "labor agitator" cannot be contented or work in the interest of his employer. A few days ago United States Commissioner Rogers rendered a decision at Baltimore, in a case where four sailors were arrested for refusing to go aboard a schooner after they had signed articles to do so. The Knights of Labor interfered and undertook to defend the prisoners. I cannot express my views better on this question than to quote from the decision of Commissioner Rogers, who said:

"I perceive you are men of intelligence, and no doubt know and appreciate the advantages of union. Every man has a perfect right to unite with his fellow man to better his condition in life. There is one great mistake made, however, and that is the constant conflict of labor and capital. Now, I can't see why such a state of affairs should exist, because labor is in itself capital, and capital merely represents labor. A capitalist you will find is a man of strictly sober habits. He has to keep a clear head, and the man who to-day earns a dollar and to-morrow morning wakes up with 75 cents in his pocket, is the man who may become a capitalist. No doubt your union is a good thing—the land we live in is a union. But now let me impress upon your minds that, while you have a perfect right to form a union, you have no right to interfere with the manner in which another man conducts his business. When a union attempts to interfere with or molest a free-born American, or tries to prevent his earning a living simply because he does not join that union, it then becomes a conspiracy, and amenable under the law and punishable by the court. The great trouble with the unions is that they overstep their bounds and endeavor to force people to do as they direct, and that is an act in direct violation of the laws which grant an American citizen his liberty. In these days of enlightenment and freedom, the press—the most powerful agent of the people—is ever ready to air the grievances of any one who is oppressed or molested. Nothing, from the great acts of a Government to the death of a pauper, escapes the eagle eye of the press. Tyrants fear the press more than any other power which can be brought to bear against them, and the press of America, as it is to-day, edited by men of the greatest ability and highest order of enlightenment, is the bulwark of the country. Now, in conclusion, let me say to you, that the man who endeavors to persuade you to fight against capital, except in a legal manner, is no friend."

I thank you for your attention, and I hope your deliberations will be characterized by the good judgment and discretion you have always heretofore exhibited.

The Executive Committee then reported as follows:

BROOKLYN, N. Y., October 15, 1890.

To the American Street Railway Association:

GENTLEMEN.—Your Executive Committee respectfully submit the following report:

#### Membership.

At the commencement of the meeting in Minneapolis the membership numbered one hundred and sixty-one companies.

At that meeting and during the year there were added the following companies:

Davenport Central Railway Co., Davenport, Iowa.  
 Union Street Railroad company, Dover, N. H.  
 Elizabeth and Newark Horse Railroad Co., Elizabeth, N. J.  
 Findlay Street Railroad company, Findlay, Ohio.  
 Hamilton Street Railway company, Hamilton, Ontario.  
 Grand Avenue Cable Railway company, Kansas City, Mo.  
 Lowell Horse Railroad company, Lowell, Mass.  
 Manchester Street Railway company, Manchester, N. H.



Minneapolis, Lyndale and Minnetonka Railroad Co., Minneapolis, Minn.  
 Mount Vernon and East Chester Railroad Co., Mt. Vernon N. Y.  
 Forty-second street and Grand street Ferry Railroad Co., New York City, N. Y.  
 Passaic, Garfield and Clifton Railway Co., Passaic, N. J.  
 Providence Cable Tramway company, Providence, R. I.  
 Springfield City Railway Co., Springfield, Ill.  
 During the year the following changes have taken place:

The changes by consolidation were:  
 Baltimore Traction company in place of Citizens' Railway company and People's Railway company, of Baltimore; both the latter companies having been members.  
 Cleveland City Cable company, in place of the Superior Street Railroad company, and the St. Clair Street Railroad Co., of Cleveland; both the latter companies having been members.  
 The Capital Street Railway company, of Little Rock, Ark., in place of the Little Rock and Citizens' Street Railway company, the latter company having been a member.  
 The Newark Passenger Railway company in place of the Essex Passenger Railway company and the Elizabeth and Newark Horse Railroad company, both the latter companies having been members.  
 Changes in name of the following companies have taken place:  
 Louisville Railway company, in place of the Louisville City Railway company.  
 Central Railway company, in place of Central City Horse Railway company, of Peoria, Ill.  
 Pittsburgh, Allegheny and Manchester Traction company, in place of Pittsburgh, Allegheny and Manchester Passenger Railway company.  
 Rochester Railway company, in place of Rochester City and Brighton Railroad company.  
 The Dayton Street Railroad company, of Dayton, Ohio, has withdrawn from membership.  
 As the result of these changes, the present membership is one hundred and sixty-nine companies. The indications are that at the present meeting there will be large accessions to our number.

*Special Reports.*

As heretofore your committee selected several subjects for special reports, covering a wide range in the street railway industry, and assigned each to a gentleman whose experience and acquaintance with the subject warranted the assignment.

The subject of the first title "A Perfect Street Railway Horse," is what the street railway manager has ever found to be the desideratum of his business, more than any other perhaps; the one thing needful to insure his success.

A perfect street railway horse, one that can live on under the trying demands of the business and die of old age, is what we have all been desiring; yet all the time knowing that it was not in flesh and blood, notwithstanding its highest brute development in the horse, to stand the stress and strain of our business. We have long realized the fact, as former reports of your committee will attest, that humanity would sooner or later secure the release of the horse from the cruel requirements of our business, and the substitution in some form or other of a mechanical motive power.

That this day is at hand is apparent to everyone, and no man will more gladly help to emancipate the noble friend who has served us so long and faithfully than the street railway manager himself.

Concerning the second subject, "A Year's Progress of Cable Motive Power," at the time of the last meeting there was being completed the construction of an extensive system of street railways to be operated by cable power in the city of Los Angeles, California. The several lines had been mainly built and put in operation under the supervision of the Company's Vice-President and General Manager (since resigned), a man who has had large experience in cable construction.

It was confidently expected that the report prepared by Mr. Robinson would give us at this meeting the latest knowledge concerning the progress of the cable power. A letter was received from him last week setting forth his inability to have his report ready at this meeting, and requesting the indulgence of the Association until its next meeting.

The third subject, "Electric Motive Power Technically Considered" was selected for the purpose of having the cobwebs, which were for the most part confessedly in our mind's eye, brushed away from this occult science, in order that it might be as plainly comprehensible to the ordinary street railway man as to the expert who manipulates the wires.

The necessity for this knowledge is becoming greater as the days go by, for the transition of roads from horse to electric power is of almost daily occurrence, so rapid is the progress made by electricity as a motive power. In this connection we take occasion to say that the information which it is hoped will be freely given at this meeting concerning the cost of operation by electricity will, doubtless, still more rapidly hasten the emancipation of the horse from his bondage.

The fourth subject, "Novel Schemes for the Development of Street Railways," was suggested by the fact that it had come to our knowledge that the exigencies of the business situation of one of our members had suggested the wisdom of inventing a novel plan for the development of that company's business, that had proved very successful. Though the nickel is a small coin it is attractive to all, and it takes a great many to satisfy us.

If we can obtain it in any legitimate way, without giving twice its value in exchange for it, surely we may congratulate ourselves on being possessed of that knowledge.

The last subject, "Public and State Treatment of Corporations—No. 2," was chosen because of the fact that the writer of the first paper could be induced to continue the good work he had so ably begun. That there is abundant opportunity for cultivating this ground, we are all fully aware. We trust that the harvest will be commensurate with the wisdom of the undertaking. We believe that it is by the circulation of such literature that the people will be enlightened as to their duty as well to themselves as to corporations.

*Street Railway Law.*

The monthly publication of judicial decisions has been continued, forming parts of volumes VI. and VII. of Street Railway Law. The numbers, according to issues and titles are as follows:

1889.

November—Herbert Francis against New York Steam company.  
 December—Memphis, Prospect Park & Belt Railroad company et al. against the State.

1890.

January—Citizens' Street Railroad company against the Indianapolis Cable Street Railroad company.  
 February—J. M. Rogers against Galveston City Railroad company.  
 March—F. W. Pelton and others against the East Cleveland Railroad company.  
 April—Martha M. Calderwood against North Birmingham Street Railway company.  
 May—Herman Weber against Kansas City Cable Railway company.  
 June—Butler Moore against Metropolitan Street Railway company.  
 July—Philip S. Taggart against Newport Street Railroad company.  
 August—Louisville Bagging Manufacturing Co. against Central Passenger Railroad company.  
 September—Ellis Newman against Phillipsburg Horse Car company.  
 October—Albert Ridenhour against Kansas City Cable Railway company.

*American Street Railway Decisions.*

The first volume of the publication entitled "American Street Railway Decisions" has been issued and makes a handsome full bound book of five hundred and fifty-seven pages. Its general appearance in binding and typography is evidence of the superior style and dignity of the work, the publication of which has been in contemplation for over two years. Now that it has been so auspiciously started, the work will be progressed as rapidly as is consistent with perfection. The compilers request a rigid and critical examination, as to the faithfulness and efficiency with which the work has been done; and the volumes which are to follow are promised to be executed with even greater care, by reason of the experience obtained in compiling the first volume.

*Street Railway Journals.*

We take pleasure in again attesting our appreciation of the deep interest manifested by the technical papers in all that pertains to the street railway business. With the advent of electricity as a motive power, several new monthlies have appeared, giving special attention to the development of this force. In this connection we venture to express the opinion that electricity has come to stay.

Let us should be regarded as invidious, we take occasion to thank one and all for the kindly regard and interest they have uniformly manifested and expressed in the welfare of this Association, and for their efforts to extend its membership and enlarge its field of usefulness in the street railway industry.

*Employer and Employee.*

The greatest social problem of the day, perhaps, that is given to the world to solve, is that of harmonizing effectually, the interests of capital and labor. These interests have been considered by many to be so opposed to each other, that they had nothing in common, and that between them there was a great gulf fixed.

We have recently seen a wonderful transformation scene take the place of that which had been set for our serious contemplation during the last few years. Labor organizations, which seemed to delight in harassing street railway companies, do so no longer. A different spirit is pervading the minds of the men, evinced by a manifestation of interest in the business, which is a novelty when compared with the experiences of a year or two since.

What has caused this transformation? We believe it is largely the result of an increased interest manifested in the personal individual welfare of the men.

The pioneer in the new movement of harmonizing the interests of stockholder and employee in the street railway business, was the Washington & Georgetown Railroad company. The president of that company, Mr. Henry Hurt, by attention to business and determined effort to succeed therein, had risen, step by step, until he became manager of that very successful company. He had learned that a majority of poor men never saved against a rainy day, or provided against the inevitable emergencies of sickness and death.

By reason of these inevitable calamities, without

money saved up wherewith to meet the necessary outlay, the laboring man is ever struggling under a load of debt, and is therefore always discontented with his lot in life. Becoming disinterested, by reason of this load of debt, the man invariably turns against his employer, and through the medium of organization, finally succeeds in bringing greater distress upon himself, while seriously annoying his employer, and often times the public generally.

The liquor saloons at both termini of a street railway, take from many men more than it would cost to insure against the cost of sickness and death in their families. To evolve a plan that would divert from the liquor saloons a sum sufficient to secure insurance against the money cost of sickness and death in a man's family, was assuredly a noble thing to conceive.

The result of these considerations was the formation by Mr. Hurt, on a wise and comprehensive plan, of a mutual benefit association amongst the employes of his company. The Washington & Georgetown Railroad company, by reason of its employes' mutual benefit society, has never known the Knights of Labor, so far as that company's business is concerned; it being impossible for that organization to obtain any recognition from the employes of that company. The financial success of this society may be regarded as phenomenal, considering the advantages of membership, when it is stated that the net expense to each member for the last eight months is thirty-eight cents.

To provide against total loss by sickness and death, to save, be it ever so little, is to be commended under all circumstances; but when this can be done under conditions that are more favorable to the insured than can be secured under any other legitimate system, it is not only to be commended for the improved condition and character of the men, but for the same reason to the company, for the manifest improvement in the service.

There are now six of these societies among the members of this Association, namely, the Washington and Georgetown, the East Cleveland, the Citizens' of Indianapolis, the West End of Boston, the Third Avenue of New York, and the Atlantic Avenue of Brooklyn.

All have been organized on substantially the same plan, though some cover broader fields than others. The uniform testimony of the members of these societies is that they are delighted with them; and your committee has dwelt at this length upon the subject in order to commend to the members of this Association the careful consideration of the advantages to their sister companies which have facilitated the organization and encouraged the existence of these societies.

*Columbus Exposition.*

The only definite action thus far taken by the Special World's Fair Committee, which was appointed at the last regular meeting, was to send to all manufacturers, supply dealers and inventors, whose names were obtainable, a circular letter, a copy of which is as follows:

BROOKLYN, N. Y., April 5, 1890.

"GENTLEMEN:—The following is an extract from the report of the Executive Committee at the regular meeting of the Association, held at Minneapolis, October 16-18, 1889.

THE COLUMBUS EXPOSITION.

"Your committee considers it wise to bring to the notice of the Association the fact that somewhere in the United States a grand World's Fair will be held in 1893, and to suggest that a committee, sufficiently extensive, as to territory, shall be appointed to secure for the street railway industry an exhibition commensurate with, and fully illustrative of the business."

"The Association appointed the following gentlemen the World's Fair Committee:

- George W. Pearson, Washington, D. C.
- G. Hilton Scribner, New York, N. Y.
- Charles B. Holmes, Chicago, Ill.
- E. B. Edwards, Philadelphia, Pa.
- Henry M. Whitney, Boston, Mass.
- Thomas Lowry, Minneapolis, Minn.
- Charles Green, St. Louis, Mo.
- Edward Lusher, Montreal, Can.
- William H. Martin, San Francisco, Cal.
- George B. Kerper, Cincinnati, O.
- William J. Richardson, Brooklyn, N. Y.

"It is confidently expected that the Street Railway exhibit under the auspices of the Street Railway Association will be one of the most interesting at the Exposition.

"Chicago having been selected as the place in which the International Exposition will be held in the year 1893, in order that a sufficient amount of space, as well as desirable location, may be secured as soon as it is possible to do so, the question of the number of square feet you desire to have secured for you, and for which you will be responsible, is herewith submitted for your determination.

"Awaiting your reply, on behalf of the committee, I remain,

"Sincerely yours,  
 WM. J. RICHARDSON,  
 Secretary."

Mr. C. B. Holmes, of Chicago, a member of the committee, and also an Exposition Director, will undertake to secure the necessary space for the exhibit to be made under the auspices of this Association. This occasion is taken to apprise intending exhibitors to make application for space as soon as the extent of their proposed exhibits have been determined upon.

*Executive Sessions.*

In regard to holding the meetings of the Association in secret, a letter of inquiry, of which the following is a copy, was sent to every member-company:

(Continued on page 186.)



**Automatic Alarm For Cable Railways.\***

The accompanying sketch illustrates a device for cable railways, designed to be placed at the end of a loop or at any point where it may be necessary to drop the cable. Experience has taught us that, while the gripman may properly perform the operation of manipulating the clutch mechanism necessary to "throw" the cable, the desired result is not always accomplished, but by the means of this device the gripman is notified when, and only when, the cable has not been properly dropped, which notice gives him an opportunity to stop his train, and thus avoid the tremendous strain both on the cable and the gripping device. In the cut shown, the cable has been dropped at the proper time, and the grip has passed on to the next loop without the alarm being sounded, while the dotted lines on the illustration shows when the cable has not been dropped as it should have been, whereupon the alarm has been sounded and the train stopped.

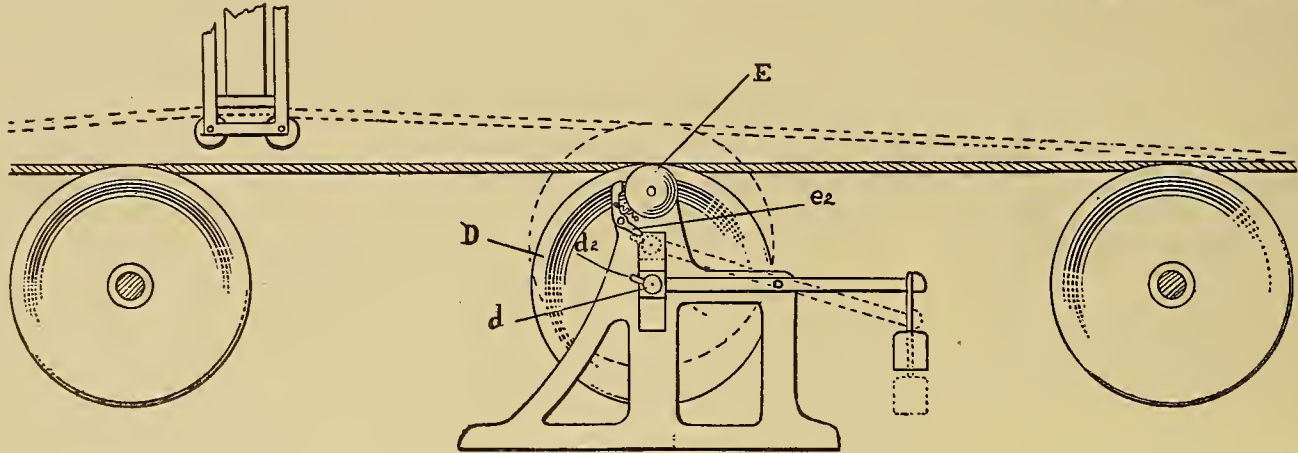

AUTOMATIC ALARM FOR CABLE RAILWAYS.

**New Pivotal Truck.†**

A glance at the accompanying illustration shows novel and important departures from the ordinary type of pivoted motor carrying trucks.

At the present time, when street railway men are favoring longer cars with greater seating capacity, higher speed, and increased traction, in order to climb steeper grades, the improvements herein described are well timed, and will be appreciated.

It is claimed that in other pivotal trucks the disadvantages are: 1st. The raising of the car body to allow clearance for the wheels to radi-

carried in the ordinary way, sleeved on one end to the axle, while the other is supported on a patent axle box frame, and can be made either the upper or lower suspension.

The brakes, life-guards, etc. are also carried on the axle box frame; the wheel base of this truck is reduced to 4 feet 6 inches and can be made 13 inches shorter if desired, the trucks running in other direction with equal safety.

**Tripp Electric Truck.\***

The growth of electrical business in all its ramifications during the past two years has been

The equalizing bar is perfectly straight which is a new departure

The boxes are simply bolted with steel pins through a lug on the box to the equalizing bar, making the removal of car body from wheels extremely easy, in fact the removal of four bolts, and the work is accomplished.

The Tripp trucks are endorsed by many of the leading railway companies of this country, not only for reason of the Tripp Anti-Friction Journal Bearings with which they are equipped, saving a large amount of power, and which are absolutely dust proof, but also for reason of simplicity and durability. The trucks are also noteworthy for the abundance of room for application of the motor, and electrical apparatus.

The company manufactures trucks for horse, cable and electric roads, and for all lengths of cars. The following representative street railways are now using the Tripp bearings and trucks which are giving perfect satisfaction:

- West End Street Railway.... Boston, Mass.
- Electro Dynamic Company... Philadelphia, Pa.
- Beverly & Danvers Railroad... Beverly, Mass.
- St. Louis Cable & Western R. R. St. Louis, Mo.
- Brooklyn St. Railroad Co.... Cleveland, Ohio.
- Citizens' Traction Company... Pittsburgh, Pa.
- Concord Horse Railroad.... Concord, N. H.
- Worcester Consol'd St. R. R. Worcester, Mass.
- Wilkes-Barre & Sub'n St. R. R. Wilkes-Barre, Pa.

While the following roads have now contracted for the trucks:

- West Side Street Railroad... Milwaukee, Wis.
- Citizens' Street Railroad.... Indianapolis, Ind.

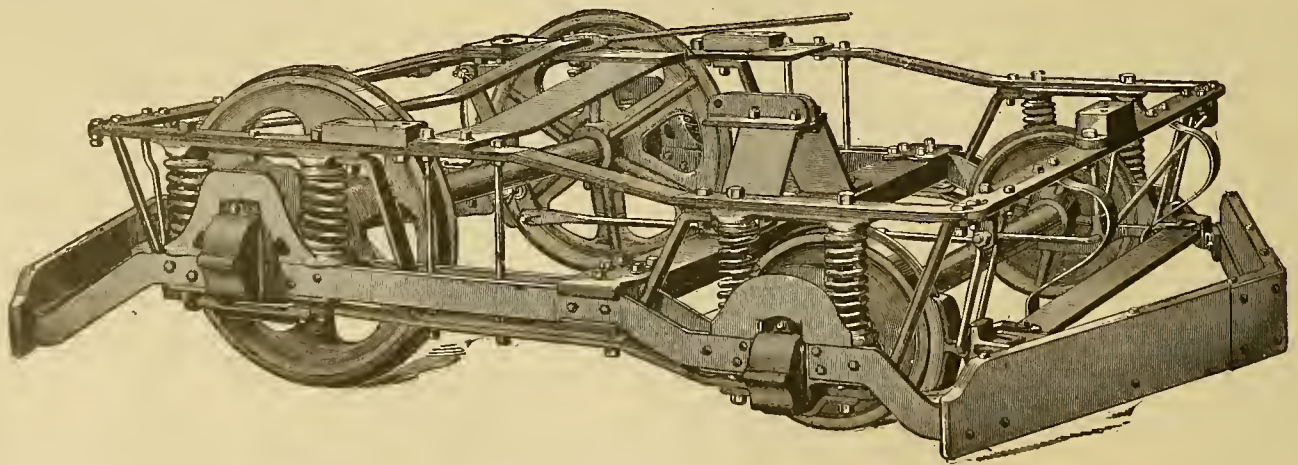

NEW PIVOTAL TRUCK.

ate, and where 30" wheels are used it necessitates two steps. 2d. The want of traction, as one motor being used in a truck only, 50 per cent. of the weight imposed on the truck can be had for traction. 3d. The long wheel base. All these objections are overcome in this truck by using 30" diameter wheels for the driving wheels, and the rear or trailing wheels of 18" and placing the pivotal centre within the periphery of the driving wheels or at any point between the centre of the truck and the centre of the driving axle; that is, out of the centre of the truck, where the pivot is usually placed, and carrying the weight of the car on the outside chord, the centre pivot plates being merely used to draw the car, and are fastened to half-inch

unprecedented, and leading electrical experts assure us, we are destined to behold still more wonderful improvements in the future.

The Tripp Manufacturing Co., of Boston, was early in the field with its electrical devices, and already its reputation has become national. However it is our purpose to speak at this time particularly of the Standard Truck, manufactured by this company, equipped with Tripp's Anti-Friction Journal Bearings, which we illustrate on the opposite page.

The truck is made for 14, 16 or 18 foot cars, with or without extension springs, which are designed to prevent oscillation of the car body. A bottom truss is required for the largest car, extending from end to end of the equalizing bar, and bolted to it by four vertical supports

- St. Paul City Railroad..... St. Paul, Minn.
- Tacoma & Steilacoom R. R. Tacoma, Wash.
- Vancouver Elec. R. R. & Ltg. Co. Vancouver, B. C.
- Derby Street R. R. Co. .... Birmingham, Conn.
- Seattle Elec. R. R. & Power Co. Seattle, Wash.

And many other companies have specified the trucks which are to be immediately constructed.

The business of the company has reached such magnitude, increased accommodations are required, and the capacity of their factory will be doubled immediately.

The Short Electric Railway company is shipping car loads of motors to Rochester every few days and will soon have the order for that city completed. The Rochester Railway company expect to have the cars of the Short system in operation in that city within the next 30 days.

\* Eugene Wendnagel, 1220 Wabash Ave., Chicago Ill.

† J. G. Prill Co., Philadelphia, Pa.

\* Tripp Manufacturing Co., Boston, Mass.



Westinghouse Motors in Greensburg, Pa.

Last week the Greensburg & Hempfield Electric Railway Company of Greensburg, Pa., started the operation of its street car line. The road runs from the Pennsylvania Railroad Station, through the principal streets of the town to Hempfield, a small suburb of Greensburg, a distance of two miles and one-half.

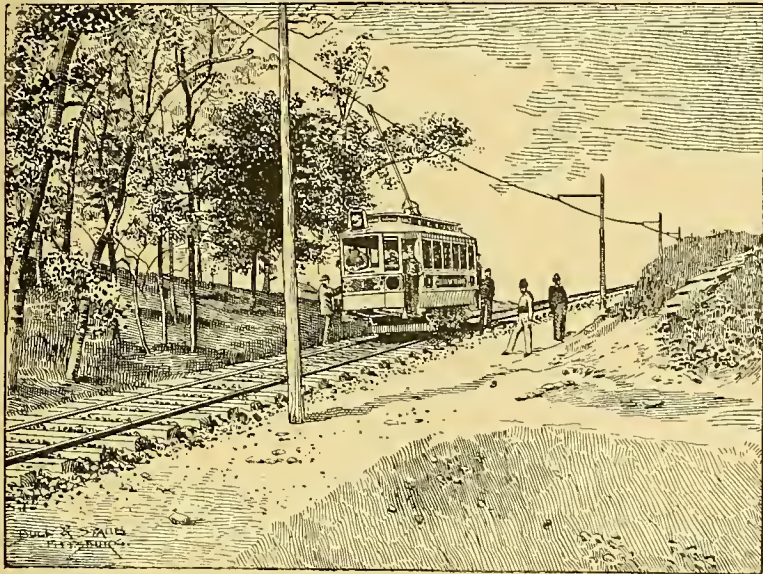

WESTINGHOUSE SYSTEM, GREENSBURG, PA.

Greensburg had heretofore no street car line of any kind, and the commencement of rapid transit by the electric system was quite an event in the history of the town. All the local papers had made an announcement of the occasion, and the hour at which the first car would come along the streets, and the public came out en masse to witness the turnout.

perfect satisfaction. To illustrate the facts of this statement, it is only necessary to give a short description of the route, which the street cars in Greensburg have to traverse.

As already stated above, the road is two and one-half miles long. In covering this distance the cars have to climb no less than eight hills, and the majority of these hills incline at a grade of ten per cent. In addition to the hills, however, the line is also peculiar on account of the large number of curves, all of them short ones, indeed there are two of a radius of fifty feet. But in spite of all these obstacles to an easy and smooth operation of the motors it is satisfactory to note, that they have given more than excellent service from the moment the first car rolled out of the shed.

Owing to the novelty of rapid transit in Greensburg generally, and of electrically propelled street cars in particular, the Greensburg residents have taxed the capacity of the cars to their utmost limit. Every car has hitherto been crowded from the starting point to the terminus and return, the cars having carried on the aver-

New Railway Truck.\*

The accompanying illustration shows in detail the general appearance of the workings of the Aenchbacher railway truck, which shown at the recent convention at the Buffalo. It is especial-

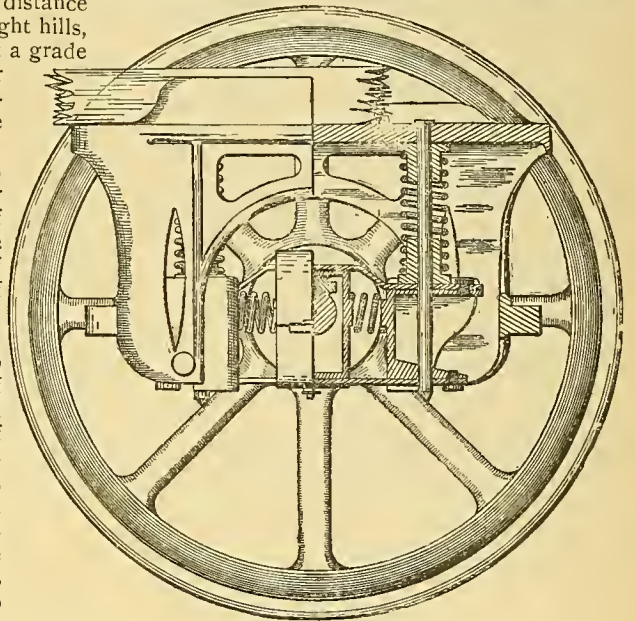

AENCHBACHER TRUCK.

ly designed for turning curves without jar or friction; the axles and wheels adjust themselves by means of horizontal springs working in harmony with the working springs, thus giving double freedom of action, not only on curves, but also where a rough track is encountered or obstructions met with on the track. When the car is started, the horizontal springs expand on being released on brake pressure, thus acting as a starter, and consequently, dispensing with spring

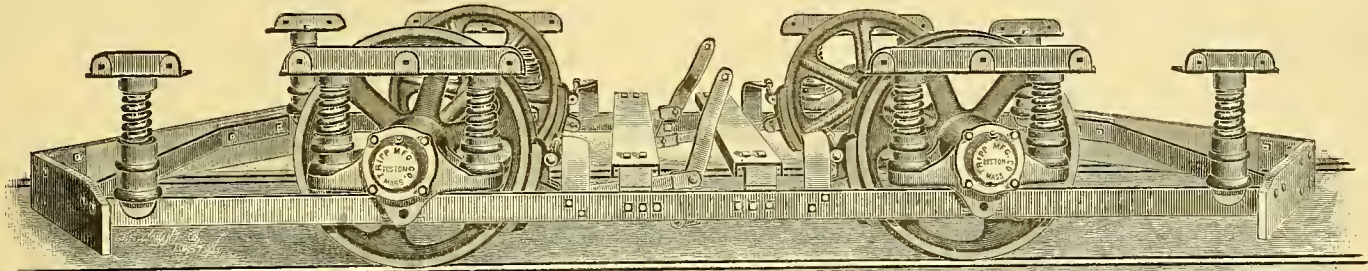

TRIPP ELECTRIC TRUCK.

The road is operated with the Westinghouse system of electric motors, and were it not that the success of that system has already been

age seventy-five passengers right along. The track is composed partially of the Johnston rail and the T rail.

With the exception of a short distance in the business portion of the town, where the tracks are laid on a asphalt-covered streets, the road-bed has been stone ballasted. The power house is situated near the terminus of the road at the foot of one of the steepest hills along the entire route. It is very comfortably arranged. The car shed and a repair shop are immediately attached to it, everything being situated level with the ground.

The motors are placed upon Brill trucks, and the body of the car is made by the Chester Car Company. The cars are very commodious and handsomely painted.

Mr. F. Y. Cloppert, a well-known Greensburg business man has charge of the road, and he expressed himself as being in every way satisfied with the equipment of the road, which he intimated could not have been better.

traces or spring draw heads.

Again, in stopping a car when the brake is applied, the action of the horizontal springs prevents the dead-locking of the wheels, thus avoiding flat wheels with their consequent annoyance to the passengers. The top sections of the dust cars are kept in position by gravity, the lower sections by springs, thus making the oil boxes practically dust proof.

THE ELECTRIC CONSTRUCTION & REPAIR CO. of Chicago will do general construction work, giving special attention to street railway construction. Several employees of the late well known Sprague Electric Equipment company have been retained for this department, and will be under the immediate charge of W. Sharpe, thereby ensuring good work and modern methods of construction. C. M. Barclay, who represented the Sprague Electric Railway & Motor company for several years in Chicago and the West, and who was also secretary of the same company, will be General Manager. Mr. W. A. Kreidler will act as Secretary, whose mechanical knowledge will be of great service to the company.

Recognizing the difficulty street railway companies encounter in having repairs done in a prompt manner and at a reasonable cost, the company has equipped a repair department, where armatures and field coils of any system will be rewound or repaired, and which will be under the management of J. G. Hart, who has had many years experience, and whose work is well known.

\* Aenchbacher Railway Truck Co., 120 Common St., New Orleans

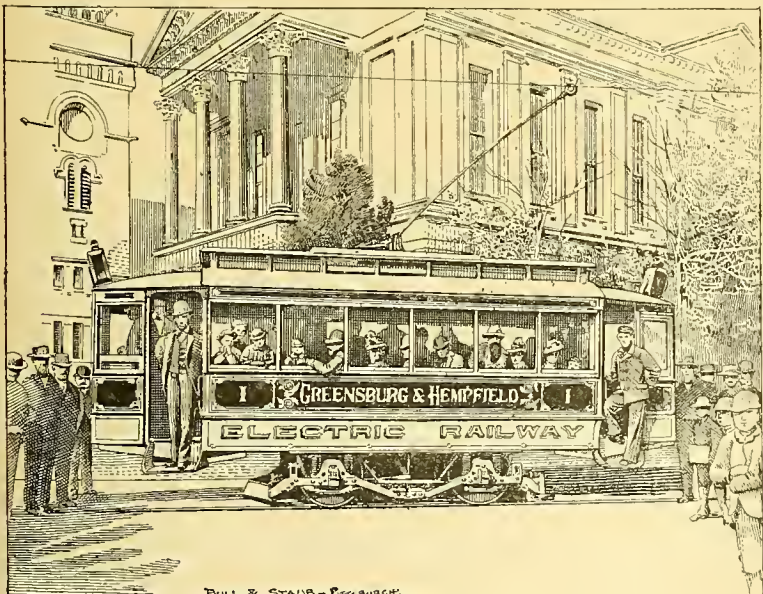

WESTINGHOUSE SYSTEM, GREENSBURG, PA.

established, Greensburg afforded a very exceptional opportunity to make the final tests; and the fact that the Westinghouse motor proved itself to be far superior even to the expectations of the Greensburg people, shows that it is giving



(Continued from page 183.)

BROOKLYN, N. Y., Sept. 1, 1890.

GENTLEMEN:—The following is an extract from the minutes of a special meeting of the executive committee of this Association, at which there were present the President, Mr. Thomas Lowry, and Messrs. C. Densmore Wyman, Robert McCulloch, George B. Kerper, Francis M. Eppley, of the Committee, and the Secretary.

"On motion of Mr. Wyman, the Secretary was requested to issue a circular, asking the opinion of the companies as to the advisability of the meetings of the Association being held in secret."

"Agreeable thereto, this letter of inquiry is sent, in order that your opinion thereon may be obtained."

"It was considered that freer discussion in the meetings would be the result if the sessions were executive. The public press has misrepresented, from time to time, by exaggeration and otherwise, to such an extent, what has taken place in our meetings, that the delegates have been made exceedingly cautious in what they had to say, and many have kept from saying anything, for fear of being harmed thereby at home. The committee was of the unanimous opinion that a letter of inquiry should be sent, in order to elicit the opinion of members in reference to the question. It is especially desirous at the coming meeting that information should be freely given respecting the cost and advantages of operation by those companies that have substituted electricity for horse power. It is for you to consider and determine whether a secret session will not conduce to the obtaining of this information freely from those in position to give it."

"Awaiting your prompt reply,

"I remain, sincerely yours,

"Wm. J. RICHARDSON,  
Secretary."

The expression of views for and against the proposition were in most cases very decided; while a few were non-committal. Replies were received from sixty seven companies, or a trifle over forty per cent. of the membership. Your committee considering the diversity of opinion, and the uncertainty of the wisdom of determining the question in advance of the meeting, has decided to do no more than recommend that there be held an executive session Wednesday evening.

At executive sessions duly accredited representatives of member-companies only should be admitted. A button worn on the lapel of the coat, on which appears the initials of the Association, the place of meeting and the year, has come to be a distinguishing feature of our meetings.

The executive committee has decided, in anticipation of the possibility of executive sessions, that a distinct button should be prepared for delegates only. This has been done—the yellow button being for delegates, and the red one for all others in attendance on the convention. This yellow button will entitle the wearer, in connection with a card, to admission to executive sessions. At all other sessions friends and others interested in the Association will be welcome, as heretofore.

#### Street Railway Supplies.

The announcement made at the last meeting that in future facilities would be afforded at every annual meeting to all dealers in street railway equipment for the display of their goods, as well as the hearty interest taken by the local street railway companies to make this feature of the meeting an abounding success, has resulted in securing an unusual and interesting exhibit, and the attendance of a large gathering of our business friends.

#### Reduced Rates of Fare.

The courtesy of reduced rates, being one fare and a third, has been extended by the New England, Trunk Line, Central Traffic and Southern Passengers Associations to all in attendance at this meeting. The greater part of the United States and Canada is thereby favored. We desire to express our sincere appreciation of the courtesy shown the American Street Railway Association by the several Traffic Associations; and trust that the large attendance from all sections of the United States and Canada will secure to the Association similar consideration in regard to future meetings. It would seem as though the community of interest between the steam and street railway business should of itself be sufficient to secure from all the Traffic Associations, independent of the number of persons in attendance, the consideration of reduced rates of fare. We hope by another year that there will be no point in our extensive territory that will not receive equal consideration with every other.

#### The Buffalo Companies.

Your Committee would fail of its duty, to say nothing of its privilege, did it not take this opportunity to acknowledge its warm appreciation of the hearty and munificent way in which the Officers of the Buffalo Street Railway Companies and those associated with them, have provided for the entertainment and comfort of all interested in this meeting.

#### Obituary.

It is our painful duty to record the death of Herman B. Wilson, the late superintendent of the Eighth and Ninth Avenue Railroads of New York.

For many years he had held this position and had thoroughly mastered every detail of the business. He was a successful street railway manager who devoted faithful attention to all the interests of these large roads. He was a man who met and carefully attended to each day's work, as it came, so that his business affairs were

always thoroughly and conscientiously performed, and he was, therefore, found by those who depended upon him to be reliable in every department of life. When such a man dies, he leaves a void in the world, and those who have had the opportunity of having him for a friend deeply mourn their loss.

Respectfully submitted,

THOMAS LOWRY,  
C. DENSMORE WYMAN,  
J. C. SHAFFER,  
GEO. W. KEELY,  
FRANK H. MONKS,  
R. SEMMES,  
FRANCIS M. EPPLEY.  
Committee.

The Treasurer's Report was read, and showed the financial transactions during the year to be as follows:

RECEIPTS:	
Balance.....	\$ 1,442 76
"American Street Railway Decisions".....	1,100 15
8th Annual Banquet Tickets.....	280 00
13 Admission Fees.....	325 00
2 Annual Dues, 1887-88.....	50 00
12 Annual Dues, 1888-89.....	300 00
144 Annual Dues, 1889-90.....	3,600 00
2 Annual Dues, 1890-91.....	50 00
Public and State Treatment of Corporations.....	10 00
"Street Railway Law".....	6 00
Annual Reports.....	2 00
	\$7,165 91

EXPENSES:	
Secretary's Salary, 13 months.....	\$ 1,625 00
8th Annual Banquet.....	1,000 00
"American Street-Railway Decisions".....	911 20
8th Annual Report.....	769 55
Special Committee Reports.....	300 00
Legal Opinions.....	204 50
Postage.....	154 00
Expenses incidental to 8th and 9th Annual meetings.....	145 23
Miscellaneous Printing.....	109 00
Expressage.....	101 25
Public and State Treatment of Corporations.....	64 00
Telegrams, stationery and insurance.....	6 23
	\$5,389 96

The balance on hand is \$1,775 95.

On invitation of the President the following companies became members of the Association at the meeting:

Asheville, N. C.—Asheville Street Railway Company.  
Attleboro, Mass.—Attleboro No. A. and W. Street Railway Co.  
Baltimore, Md.—Baltimore City Passenger Railway Co.  
Evansville, Ind.—Evansville Street Railroad Co.  
Lancaster, Pa.—Lancaster City Street Railway Co.  
Lawrence, Mass.—Merrimac Valley Street Railway Co.  
Newburyport, Mass.—Black Rock and Salisbury Beach Street Railway Co.  
Newton, Mass.—Newton Street Railway Co.  
Paterson, N. J.—Paterson Railway Co.  
Portland, Ore.—Willamette Bridge Railway Co.  
St. Joseph Mich.—St. Joseph and Benton Harbor Street Railway Co.  
Toronto, Canada.—Toronto City Passenger Railway Co.  
Wheeling, W. Va.—Wheeling Electric Railway Co.

Charles Odell, Committee on the Perfect Street Railway Horse, then presented the following report:

#### MR. PRESIDENT AND GENTLEMEN:

The perfect Street Railway horse, when found, should be the best horse in the world; not big, but a sturdy animal with an easy gait.

I would select a horse six years of age, as with proper care during acclimation period, and good keeping thereafter, he should last for from 5 to 8 years, and if not so long, you would have the best years of his life for service.

He should have strong joints, ankles, hocks and knees; stout and strong cannon bones; a wide leg with a very strong back sinew. His back should be short and strong, with a firm and even loin, and well coupled at the hip; his head should be clean, bony and of medium size, not too large or too small; wide between the eyes, and of good length from the eyes up to the ears. He should have large nostrils, eyes clear and full, ears well set upon the head, and not too far apart; the head should be carried in an easy manner, well up above the withers, for the reason that as check reins are not used, the horse if low headed must necessarily travel heavy and appear lifeless, a combination which would not reflect credit upon the corporation owning him.

He should have a strong and level rump, and inasmuch as the way in which a horse carries his tail indicates his strength and courage, and as a horse that hugs his tail is apt to be a dull animal, he should carry his tail free and arching. He should be deep in his body behind the shoulders, that is through the region of the heart; the shoulders should be oblique with a very strong base, and with good length from point of elbow to point of shoulder, The breast should be full, with the forward feet and limbs

well under the body; and it is specially desirable that the forelegs should be firm and strong, with wide knee joints, and strong ankles, and the forefeet which are particularly liable to disease should be round, open at the heel, and neither too flat nor too high. He should have limbs strong and well proportioned, not the limbs which one would look for in a race horse, nor the round clumsy limbs of the truck horse, but a happy medium.

Behind, he shou'd have a good clean open gait, should travel wide, should not strike, or require unusual attention from the blacksmith. This is an all important feature in the car horse, as otherwise, when weary from overwork, or owing to the wet and slippery condition of the roadway, upon which at times he is compelled to travel, he is liable to cause serious injury to himself as well as great annoyance to his owners. In regard to the matter of weight and height, he should weigh about 1075 lbs. in good fair flesh, and stand 15½ hands high.

The temperament of the horse is a very important factor in his make-up, as upon the same depends to a large degree his efficiency. An amiable horse, other things being equal, will outwork and outlast a vicious and bad tempered one. The eye is usually a sure indicator of the temper, and if to an evil eye there be added a nervous temperament, you may be sure that the possessor will make trouble for himself and for all other horses with which he is associated.

Nothing is so trying to a well inclined horse, disposed to do his duty, as to be associated with an ill-tempered mate, whose contrary actions are even more troublesome than a slow and sluggish partner; and how often do we see a good car horse, ready at all times to do his work, annoyed, distressed, and tormented by a mate which is rearing, balking and starting with such force that he takes the car, its passengers and his mate with him for a car's length. As is well known, it is the business of a horse-car to stop in a crowded city at least twenty times to the mile; and every time that it starts, the repetition of such scenes as I have described, is enough to kill a vicious horse, and exhaust a good one that is obliged to work in his company. The perfect car horse should therefore be possessed of an amiable disposition; he should be an ambitious horse, and he should not worry or fret over his work. For the comfort of travellers and for the comfort of good horses, the contrary animal should be banished from every horse railroad stable.

As our horse must necessarily come to his work unbroken, before he is harnessed to a car, it would seem to be a good idea to in some way prepare him to his calling, that he should become accustomed to the harness, etc., either at the hands of the breeder, or by some preliminary work at the hands of the company.

Having found the perfect car horse, let us see to it that he is not injured in body or in spirit during the breaking. Let us see to it that his life of usefulness is prolonged for as many years as possible, and this can be done in no way save that of bringing him to his work, moderately and gently until accustomed to it, and thereafter treating him with that care and consideration which an intelligent animal alone deserves.

Respectfully submitted,  
CHARLES ODELL, Committee.

On motion, the report was ordered to be received and placed on file.

Mr. Richardson.—On one item mentioned in the report, the preparation of the horses for their work, I think there is no gentleman that can give us more practical information than Mr. Wyman, Vice-President of the Central Park, North and East River Railroad Company of New York; which company, after their fire in which nearly twelve hundred horses were destroyed, had a great deal of experience in preparing several hundred of them for their work; and a knowledge of the results of their preparation I think will be very valuable to the Association.

The President.—We shall be very glad to hear from Mr. Wyman.

Mr. Wyman.—Mr. President and gentlemen: I had not anticipated speaking upon this topic; because the results of the occurrence of which Mr. Richardson speaks were so unfortunate and sad that I hardly like to tell the story, or even think of it. We did gain some experience in the matter of preparing the horse for his work, losing in one night eleven hundred and fifty-one, and being obliged to purchase an entirely new stock, and yet at the same time to try and keep them at work. We built five temporary stables to stable our horses as we got them from the west. We found that to put a horse immediately to work and to try to get anything like full work out of him was a failure; however strong and sound he might be. However healthy to all intents and purposes he might be, and however strict an examination we might give him prior to putting him to work, we found that to get more than five or six miles every other day out of him, was prejudicial to his health and in many instances fatal. We were obliged to work our horses very slowly indeed; that is to say, very few hours each day, and give them at least one day's rest a week. And even at that rate in the first three months out of nine hundred horses we had four hundred and fifty in hospital, while they were dying very rapidly. Our system, therefore, now and since that time, has been to give a horse about six miles every other day for the first two weeks of his stay with us. Of course we would grade his feed, that is to say, give him but one portion of soft food a day, and give him two feeds of oats, though our regular food to the acclimated horses is three feeds of grain and cut hay mixed



together with water. Then after the horse has been working that way for a month, we increase this proportion; but it generally takes about three months to get him in such condition so that we are really able to get full work from him. In the mean time we find that we have to take measures to acclimate his feet to the pavements by putting on a heavy shoe at the start gradually lightening it as he becomes more and more accustomed to our pavement. So, practically, the horse has to be refreshed and refooded and restomached in about three months before he is really got into condition to give us the full benefit of his strength and to give us full work

The President.—The next report in order is that on "A Year's Progress of Cable Motive Power." I understand the secretary has a letter from Mr. Robinson who was to present the report.

The secretary read the following letter:

SAN FRANCISCO, CAL., September 30th, 1890.  
WM. J. RICHARDSON, ESQ.,

Secretary American Street Railway Association,

MY DEAR SIR.—I have to express very deep regret that owing to recent changes in my business affairs, it will be impossible for me to present at the forthcoming meeting of the Association, the report entrusted to my charge, viz., "A Year's Progress of Cable Motive Power."

The difficulties encountered by me during the early part of the year at Los Angeles, when almost unprecedented storms and floods interrupted and delayed the completion of my work in that city, precluded my giving, at that time, any attention to the preparation of the report.

I hopefully relied upon the latter portion of the year affording ample opportunity in which to compile the necessary data, and in complete form do full justice to the important subject; but "Man proposes and God disposes."

The arrangements whereby the transfer of the Los Angeles roads were effected, were so unexpectedly consummated, that a change of base and my prompt organization of the California Contract Corporation, at San Francisco, was rendered imperative.

These considerations, together with their contingent necessity of frequent movement, have quite absorbed my attention, and, at this juncture, made it quite impossible for me to thoroughly complete my paper in time for your convention.

Under these circumstances, I would respectfully crave your kindest indulgence; and further, I would ask that the powers invested in me as a Committee be continued for another year, when, if privileged, it would be my pleasure to submit to the next Convention a full and adequate report to date on "Cable Traction," worthy alike of the subject and of The American Street Railway Association.

Very faithfully yours,

J. ROBINSON.

Mr. Richardson.—I would move that the time asked for by Mr. Robinson of one year in which to prepare his report on the cable power be granted. The motion was adopted.

The President.—The next report is "Electric Power Technically Considered," by Mr. W. L. Allen, of Davenport, Iowa.

The secretary read the report, as follows:

REPORT OF THE COMMITTEE ON ELECTRIC MOTIVE POWER TECHNICALLY CONSIDERED.

To go over the entire subject of electricity for street railways, and consider all the technical details, would occupy too much of your time. The subject naturally divides itself into

- (I) The Central Station.
- (II) The Transmitting Line.
- (III) The Motors.

The National Electric Light Association has so fully and exhaustively considered the matter of Power or Central Stations, that, most fortunately for street railway men, this subject is one that troubles us but little; but there are some points in which our work differs materially from that of an electric lighting station.

The engine we require must be strong in all its parts, for there is no work where the demands on it vary so suddenly and so frequently, from the entire absence of load to the extreme capacity of the engine as in street railway work. Some roads report that the cars average but five horse power each; supposing that such a road has eight cars in operation with one 150 horse power engine in the station, and, as is often the case, the cars either become bunched or happen to start at the same instant; here a sudden demand is made upon the engine for 150 or 200 horse power, while a moment later the meter may register but 40 horse power. You will, of course, be provided with safety plugs and current breakers, but you cannot allow safety strips to be blown out half a dozen times a day, possibly just at the moment you are ascending a heavy grade.

Electric light men state that a station with a number of small high-speed engines is more economical on account of being more flexible in its operation, but in their business the loads upon the station vary gradually, while we may be called upon at any moment for our maximum capacity. To arrange our station for this varying load, and at the same time avoid operating a tremendous engine on an average light load, is a problem that experience must solve for us. We are also more greatly troubled with lightning than we should be. There should, first of all, be established as perfect a ground connection as possible, either by means of a well or a deep hole; it is better to have two grounds and

thereby make sure of a moist contact for galvanized ground-plates or rods; then with proper lightning arresters so placed that they can be conveniently examined and kept in order, we will be fairly well protected; but with our great lengths of exposed trolley wires we are very certain to have frequent calls upon our lightning arresters, and those in use at the present time are not such as to warrant perfect confidence.

Are we not all personally firm believers in the overhead system of transmission? What can there be simpler, cheaper, more durable and more convenient? We have only poles, bare copper wire, galvanized iron span wires, insulators, and where needed, additional feed wires, of which these last can be placed under ground if desired. It is a rare thing to have a trolley wire break except at the curves. Curves are certainly troublesome on account of the constant liability of trolleys to jump off at some sharp angle, and the trouble is more generally due to faulty trolley stands, wheels or springs than to the overhead wire. For insulators we have only those for the straight lines and those for the curves; and I show you a sample of each, such as were used two and a half years ago on one of our lines. It is not to be wondered at that street railway men at that time considered electricity, for the rough usage required by street railway work, to be in an embryonic stage of development. There is little to be asked for in the way of improvement of what we now have for overhead material. There is practically no difference whether we use the Thomson-Houston system, Sprague-Edison, Westinghouse or what not. A single trolley wire which may be large and heavy, say 00, and thus avoid feed wires where distance for transmission is not too great, or the wire may be small, say number 4, light and easy to handle with, in that case, the necessary feed wires. We can take our choice and find equally good results with either. It will often be convenient to utilize both plans, with the large trolley in the central parts of the city where feed wires might not be desirable, and with the small overhead and feed wires to reinforce the suburban parts. Undoubtedly the small wire is more easily handled and repaired in case of a break, and the feed wire prevents a dead line being the result of a break. The rail bonds may be galvanized iron, which costs but four cents, instead of tinned copper, and the supplemental ground wires can be of the same material. The supplemental wires do not give any better return except so far as to prevent a bad break in the return circuit, which might occasionally be caused by the breaking of both rail bonds at neighboring joints. Rails on both sides of track should be connected with bonds.

It will not be necessary to discuss the merits of the conduit system or the storage battery. Actual experience has proven that there need be so little trouble or danger from the station and overhead line that we cannot concede the need of either conduit or storage battery, so far as we are concerned. It is true that the ever-restless mind of the public has been so stirred up by accounts of the numerous successful storage-battery and conduit railways that it has suddenly (and to us most unpleasantly) become aware of the fact that we are using poles, and while we are congratulating ourselves upon the beauty and symmetry of our neat line of poles it suddenly demands that we remove what it terms our unsightly poles. Nearly every one of the street railway men present will uphold the statement that the only problem before us, and the one about which we are always anxious, is, "What can we do to keep our motors out of the repair shop?" We don't worry about our station or our overhead wires; we scarcely have time to think of them; we are constantly at work upon and perpetually annoyed by our motors; a lame armature, a burnt field magnet a broken gear—these are our every-day trials. A motor, such as is made by the Thomson-Houston, Sprague-Edison, or Westinghouse companies has among its mechanical parts an axle gear and intermediate shaft gear, shaft pinion and armature pinion, and the axle and intermediate shaft and armature have each their boxes or bearings. We want gear and pinions to be wide and heavy enough not to break. We don't want any more pinions like this, which was in use two years ago. We want gear of some material that will be reasonably durable, and at the same time noiseless; cast iron may do for the axle gear, which is large and runs slower, and steel for the intermediate shaft pinion; steel, we believe, is better than bronze, as it lasts longer, and is less expensive. To overcome the noise it is necessary either to have the gear covered and running in oil, or to have the gear of wood or the pinion of raw hide. The large gear on the axle and intermediate shaft, if made with wooden teeth and used with steel pinions, certainly runs noiselessly, and it ought to make the life of the pinions much longer. Care must be taken to have the keys, in all gear and pinions, tight and self-retaining. The shaft boxes and bearings must be made of some compound metal that will not wear out too fast, for but little wear on the armature bearing will allow the armature to scrape on the pole pieces of motor, be damaged and laid up for repairs. Aluminum bronze gives satisfaction as material for the bearings.

The electrical parts of the motor in which we are most interested are the armature, field magnets, and the controlling switch or rheostat. The armature of an electric motor is its most wonderful and interesting, as well as its most expensive and troublesome part. A street car is the most overloaded vehicle known to mankind. It may run a week with a light load and then suddenly receive enough passengers to load fairly well three or four ordinary cars; the motorner may forget to oil either the car or motor, he may reverse motor accidentally or purposely to avoid an accident; these and many other causes require of an armature more work than it is capable of, hence a burn-out. On the other hand, the armature itself may be at fault; an armature such as we

use to-day consists of a shaft surrounded by a metallic core. Around this core is wound the best insulated wire, each coil terminating at the same end of the armature and being attached there by means of solder or screw to the bars of the commutator. The shaft of the armature will in a few years become worn by its bearings, and it would be well to have bushings or sleeves placed around shaft at those points, such as the Thomson-Houston Company use, which sleeves can be removed. As there is no wear to the core, and as the commutator can be renewed when worn down, which ought not to occur in less than two or three years, an armature should then have as long a life as one could desire, were it not for the coils of wire. Where these coils cross around the head of the armature they chafe on each other and destroy their insulation. Where they end in the commutator they loosen; by an excessive load or careless driver they burn out. It may be possible to repair the armature by rewinding one coil or by refastening the loose ends, and even when a deep coil is burnt the total rewinding with new wire should not cost but forty or fifty dollars. Could we but prepare for the burn-outs by having the car on some side track near the repair shop where it would not interfere with our running time or cause a hindering of cars, we would not feel so aggravated, but it happens invariably at the time we need every car most urgently. We can watch our gear and bearings, and when worn they may be replaced at our convenience or at night, but an armature gives out without warning. It is on this account that those systems advocating but one motor to a car, must give us positive assurance of no burn-outs, for were it not for the double motor now so generally in use we would see crippled cars being *toned* into the shop greatly to our discomfort. In the matter of minor details such as cables, terminals, trolleys and gearing, the electric manufacturers have made the greatest improvements during the past eighteen months, but so far as we can obtain information based on actual facts, there has been but little improvement in the armatures. The Edison Company has recently announced a new armature, but we have been unable to learn what results it may show.

The switch-box, such as used by the Sprague-Edison and Westinghouse, is an apparatus, that if given proper care, so as to keep the brass plates and buttons smooth, ought not to cause much trouble. It is arranged so as to distribute the current through different parts of the magnets or the motor according to the degree of speed or work required. It is somewhat in the way of passengers when the platform is overcrowded. The rheostat used by the Thomson-Houston Company is out of the way, being underneath the platform, although it is burnt out occasionally and damaged by rain leaking through the platform; these defects should be easily overcome. It is claimed that owing to the use of the rheostat of the Thomson-Houston Company and the resistance coils as used by the Westinghouse Company, that the cars start much more easily and without jerking, and that the motor is less liable to burn out, as they avoid throwing in an excess of current. The first claim is true, but we cannot find evidence to support the latter claim. On the other hand, it has been claimed that motors using a rheostat require on an average run from 15 to 20 per cent. more power than the Sprague-Edison motor. It does not necessarily follow that this is due to the rheostat; it seems likely that it is due as much to the difference in the winding of armature or fields. It would be more desirable, therefore, to ascertain from our various members the actual number of burnouts of fields and armatures, of both varieties of motors, and at the same time the average power used per car. This cannot be obtained by writing for reports as many roads do not keep an exact record, or will not report the same. The grades of roads must be considered, the car mileage, and the loads carried, also the system or manner with which motors are repaired and cared for.

This is a matter of the greatest importance. Our fuel costs about \$1 per car per diem, and our repairs over \$1.50 per car per diem. If we can save 10 per cent. each day, on fuel, by giving up the rheostat we do not want to do it at the expense of adding 25 per cent. to our repair account which, we all know, is too large already. As an example of the approximate cost of repairs I give the cost of four 30 horse power Sprague cars for the six months ending October 1, 1890, each car making 90 miles a day, a grade of 1,900 feet of 9 to 3 1/4 per cent., one 300 feet of 5 per cent., one 300 feet of 8 per cent.

Mechanical.

3 Bronze intermediate pinion, at \$14.....	\$ 42 00
3 Steel intermediate pinion, at \$9.....	27 00
8 Steel Armature pinion at \$7.....	56 00
4 Intermediate Gear, at \$11.....	44 00
2 Main Gear (axle), at \$16.....	32 00
6 Axle brasses, at \$4.50.....	27 00
8 Shaft bearings, at \$4.50.....	36 00
12 Armature Bearings, at \$2.75.....	32 00
Total.....	\$296 00

Electrical.

180 Carbon Brushes, at..... 10 cts.....	\$ 18 00
6 Trolley Wheels, at..... \$1 25.....	7 50
3 Field Magnets, at..... 20 00.....	60 00
6 Armatures repaired at 35 00.....	210 00
	\$295 50

For Labor:  
2 Motor repair men, at \$50.00 per month .... 600 00

Total..... \$1,191 50

Average per diem, per car, \$1.62.



There are other minor repairs that would increase this about 20 cents a day.

Fuel, sawdust and slabs, \$1.30. This fuel is about equal to screening or slack at \$1.50 a ton. A greater number of cars would reduce this fuel account per car. During the six months the expense on the overhead line was less than \$25 on five miles of line.

We have learned of an eight car road running at \$1 per car for fuel, another six-car road at 90 cents per diem per car. We do not believe in any case that the fuel will equal the cost of motor repairs. The first year of operation must not be taken as a fair estimate. The prices for gear and bearing will vary considerably from those given above. Some axle brasses cost \$9, while those above are given at \$4.50. Aluminum or some such compound may be mixed and used to decrease the cost and increase the durability of bearings. It was sold a few years ago \$3 and upwards per pound, now at \$1, and it is stated can be produced for 20 cents per pound.

In the matter of gear the Westinghouse Company has so boxed the same that it can run in oil and grease; this must undoubtedly add much to the life of the gear and pinion, and at the same time practically deaden the noise. Whether this boxing will stand the wear and jar, time will best demonstrate.

The following report of a road operating Thomson-Houston motors is most valuable in showing the proportion of cars disabled from electrical and mechanical causes. During fourteen consecutive days in July, 1890:—

Equipped.	Operated.	Disabled.	
		Electrically.	Mechanically.
286	150 to 200	0	15
286	150 to 200	0	12
286	150 to 200	2	12
286	150 to 200	5	8
286	150 to 200	0	11
286	150 to 200	3	11
286	150 to 200	3	9
286	150 to 200	1	10
286	150 to 200	5	7
286	150 to 200	2	11
286	150 to 200	2	15
286	150 to 200	2	13
286	150 to 200	1	12
286	150 to 200	0	12
		26	158

In seven consecutive days in August:—

Equipped.	Operated.	Electrically.	Mechanically.
308	150	3	10
308	150	5	11
308	150	0	9
308	150	4	7
308	150	0	5
308	150	4	5
308	150	1	8
		17	55

During seven consecutive days in September:—

Equipped.	Operated.	Electrically.	Mechanically.
312	150	2	3
312	150	5	3
312	150	3	2
312	150	3	3
312	150	0	5
312	150	1	4
312	150	1	4
		5	24

From this it appears that in July about 1 per cent. of cars operated were disabled each day from electrical causes, and about 6 per cent. from mechanical causes, and this during a period of extraordinary heavy business.

During the August period the electrical trouble appears to have increased slightly in excess of 1 per cent., and the mechanical decreased to about 5 per cent., and in September the mechanical trouble decreased to about 2 per cent. This decrease was probably due, in some degree, to a lighter business and less mileage. As the report does not state the nature or degree of the electrical disabilities, it is not fair to assume that they were all due to crippled armatures, but we can deduce from it that a car ought to run 100 days without electric repairs.

October, 1890.

WM. J. ALLEN,  
Committee.

On motion of Mr. Monks, of Boston, a vote of thanks was tendered to Mr. Allen for his very able and instructive paper. The Secretary was also directed to have copies printed and distribute two to each member of the Association.

The Secretary read letters from the Buffalo Library, the Superintendent of the State Reservation at Niagara Falls, the Niagara Falls and Suspension Bridge Railway and others, offering the use of the institutions included in the several letters to the delegates during their stay in the city, and while on their visit to Niagara Falls.

On motion, votes of thanks were extended to the institutions named.

The Association then adjourned to meet in executive session in the evening.]

WEDNESDAY—EVENING SESSION.

This session being executive, the deliberations thereof were not open to the press. It is understood, however, that the discussion was mainly confined to the cost of operation of cars by electricity, and that the facts elicited did not differ much from the figures as presented in the report above. By request of the gentlemen participating in the discussion, the same was withheld from publication when requested.

Mr. George W. Mansfield, of the Attleboro electric road, addressed the meeting as follows:

I came here, like many others, to listen and learn. I am a director in the road, and take a deep interest in its operation; but I cannot give you any specific and accurate figures in regard to the cost of operating the road, either for power or repairs to the motor. We hire our power, and are in one of those unpleasant predicaments that no doubt many other electric railroad men have found themselves in when they came to pay another concern for the power supplied to their car. Some of these companies want from three to five dollars per day for the first three or four cars, and perhaps fall off fifty cents per car thereafter. I have even heard that one company wanted eight cents per car mile. I doubt not that in the East, and in a great many other places, they are paying in the neighborhood of from four to seven dollars a day on small roads of from four to seven cars, the cars making in the neighborhood of one hundred to one hundred and twenty miles a day. I do not know but that in some cases the electric light companies are warranted in making such a charge. They may have to pay four dollars and a half or five dollars a ton for coal; and I know that electric railway managers get all they can out of their electric cars. When an electric car has to climb a grade of eight or nine per cent., with perhaps ninety or one hundred passengers on it, there is a pretty severe strain on the steam engine; and perhaps, at the time it gets up or half way, some thing necessitates the current being cut off and the brakes applied, and then the car starts again under these conditions. The indication of the steam engine on one car under these conditions has run as high as seventy-one or seventy-two horse power. In Albany, on the Capitol Hill, they stop halfway up the grade, about an eight per cent., and they have very heavy traffic too. In a general way it has been my experience that the cost of operating an electric car per mile—and the mileage being in the neighborhood of one hundred and ten miles, not to exceed one hundred and twenty or fall below ninety, perhaps—I make that provision since I know of some roads running as high as one hundred and sixty miles, which is an excessive duty to impose on the car, but if the manager of the car permits it and he has to pay ten cents per car mile on repairs, it is nothing more than he ought to do. I say in the neighborhood of one hundred and ten miles, and under average conditions, perhaps grades of five per cent., I think that in a great many cases under these conditions, counting simply the maintenance expenses, meaning the oiler, wipers or cleaners, grease, repairs to all of the electric apparatus on the cars, including even the truck, and not including any fixed charges or anything of that kind at all, the cost of operation can be reduced to the neighborhood, on large roads, of about three cents per car mile. On small roads it costs more; perhaps four or four and a half. The whole matter is very largely a question of brains on the part of the managers of electric roads; and so far as my observation goes, there is somewhat of a want in that direction. By brains, I mean an intelligent mechanical inspection of the car and maintenance of the electrical apparatus. On this account largely it is difficult for any man to give at this time any accurate figures in regard to both the operating expenses and repairs of cars, and at the station, that would be applicable to all roads.

Mr. R. J. McCarty, Superintendent of the Metropolitan Street Railway company, of Kansas City, Mo., read a paper on the comparative cost of horse, electric and cable motive power for street railroads, which we give as follows:

MOTIVE POWER FOR STREET RAILWAYS.

The cost of motive power for horse, electric and cable railways, respectively, as shown in detail below, has been computed from statistics, and includes every item of expense necessary to deliver power to the cars.

Upon a horse line three and one-half miles long and operating an average of thirteen cars on easy grades for a period of six months, the cost of motive power per car mile was as follows:

Stable Service, Wages of Hostlers, ..	\$ .692 c.
Stable Expense, Harness Repairs, ..	
Veterinary, Water, etc. ....	.138 c.
Hay and Grain.....	1.687 c.
Horse Shoeing.....	.201 c.
Renewal of Live Stock.....	.354 c.
Total.....	\$3.072

Upon an electric line four miles long and operating an average of ten motor cars for a period of six months, the cost of motive power per car mile was as follows:

Engineers and Firemen.....	\$ .540 c.
Repairs of Engine and Machinery ..	.002 c.
Oil and Waste for Engines.....	.029 c.
Fuel for Engines.....	.829
Water for Boilers.....	.051
Repairs of Dynamo and Motors....	1.223
Repairs of Line and Trolleys.....	.291
Lubricants for Dynamos and Motors ..	.113
Total.....	\$3.078

Upon a cable car line three and eight tenth miles long, and operating, on an average, 17 trains over heavy grades and crooked alignment, the cost of motive power per car mile was as follows:

Engineers, Firemen and Helpers ...	.296
Repairs of Engine and Machinery ..	.491
Oil and Waste for Engines.....	.026
Lubricants for Cables and Pulleys..	6.043
Fuel for Engines.....	.590
Water for Boilers.....	.057
Renewals and Repairs of Cables...	1.425
Total.....	\$2.928 c.

The above figures are, of course, all obtained by dividing the total of each item of expense by the total car mileage.

Now, since in the case of the horse railway, the total expense for motive power increases almost exactly in proportion to the number of cars operated, and therefore to the total car mileage, it must follow that the cost per car mile will be practically the same on any particular line, no matter how many cars are operated.

In the case of the electric railway, the total expense for engineers and firemen, repairs of engines and machinery, and oil and waste for engines is practically constant, and hence these items of expense per car mile, will be inversely proportional to the total car mileage. The total cost of fuel does not necessarily increase with the number of cars operated, and under some circumstances may increase but slightly under a large increase of car mileage, yet under certain conditions, the increase in fuel may be comparatively large. Under average conditions it may be assumed that the increase of expense for fuel is to the increase in car mileage as two is to three, and hence the cost of fuel per car mile will diminish as the total car mileage increases, and the same may be said of the total expense for water.

The total expense of repairs of dynamos and motors, lubricants for dynamos and motors, and repairs of line and trolleys may be assumed to increase in proportion to the total car mileage on any particular line. This assumption, while not correct, is sufficiently accurate for present purposes, so that the cost of these items of expense per car mile will be practically constant for the same line.

The total expense for engineers, firemen and helpers, repairs of engine and machinery, oil and waste for engines, lubricants for cables and pulleys is practically constant for any particular cable line whatever may be the number of cars operated or the total car mileage.

The total cost of fuel and water for any cable line may, as in the case of the electric line, be assumed to increase with the total car mileage as two is to three, and the total cost of renewal and repairs of cables may be assumed to increase in the total car mileage in the proportion of two to four.

Should both the electric and cable line have made only the mileage of the horse line mentioned, the cost of motive power per car mile, figured in accordance with the above would have been on each line as follows: viz:

On the Horse Line.....	\$3.072 c.
On the Electric Line.....	3.427 c.
On the Cable Line.....	8.859 c.

Had the horse and cable line made the same mileage as the electric line, the cost of motive power per car mile similarly calculated would have been:

On the Horse Line.....	\$3.072 c.
On the Electric Line.....	3.078 c.
On the Cable Line.....	7.069 c.

Had the horse and electric line made the same mileage as the cable line, the cost of motor power per car mile similarly calculated would have been:

On the Horse Line.....	\$3.072 c.
On the Electric Line.....	2.361 c.
On the Cable Line.....	2.928 c.

Had the car mileage on each of the lines been four times the actual mileage on the cable line, the cost of motive power per car mile similarly calculated would have been:

On the Horse Line.....	\$3.072 c.
On the Electric Line.....	2.068 c.
On the Cable Line.....	1.334 c.

The above figures show that for small traffic animal power is the cheapest, electricity next, and cable traction the most expensive of all. As the traffic increases, electricity at a certain point becomes the cheapest of the three, and a very large volume of traffic results in making cable power much cheaper than either animal or electricity.

This advantage which the cable has under a large volume of traffic is so great as to more than counteract the immense difference in first cost.

Leaving animal power out of consideration, investigation of the comparative merits of electric and cable lines made recently (including, of course, the interest on the investment), led to the following conclusions, viz:

1 That for comparatively light traffic and easy grades electricity is preferable.

2 That after the traffic reaches a requirement of fifty trains on a four mile line perfectly level and straight, it can always be handled to better advantage by cable.

3 That a greater average speed can, under any conditions of heavy traffic, be obtained with the cable, by reason of the time lost in stopping and starting electric cars, and hence the cable under such circumstances can give better service and is better adapted to meet competition.



4 That with grades of any consequence electricity is at a disadvantage on account of the consequent loss of speed, and that this feature reduces the limit of traffic which can be handled more economically than with the cable, by an amount depending upon the length and severity of the grades, and that it might easily happen that even should something be saved in expense by using electricity on any particular line, it might be lost by competition.

5. That the question as to whether a cable line is preferable to an electric line must be determined for each particular case from conditions of grade, alignment, probable volume of traffic, and the nature and extent of existing or probable competition.

In regard to the comparative loss of power in transit, the following may be of interest: In the case of a four mile cable line with the power house at the middle point, if the line is reasonably straight the loss from friction of engines, machinery, and cables, is about 140 h. p., while the average total load may vary from 280 to 500 h. p., according to the volume of traffic, so that on such a line the average loss of power in transit may vary from 28 to 50 per cent. The greater the load the less the loss.

In the case of electrical power on the same line there would be a constant loss of 30 per cent. at the dynamos and motor, and a variable loss from circuit resistance depending on electrical conditions.

On a four mile electric double line, with power house at the middle point, with 500 volts pressure, with trolley wires with large O gauge, and no feed wires, the theoretical loss would be as follows:

Power developed at engines 147 h. p., loss 53.32 h. p.

36 per cent.

Power developed at engines 159 h. p., loss 59.00 h. p.

37 per cent.

Power developed at engines 188 h. p., loss 72.60 h. p.

39 per cent.

Power developed at engines 259 h. p., loss 111.14 h. p.

43 per cent.

Power developed at engines 621 h. p., loss 396.75 h. p.

64 per cent.

This loss could, of course, be made much less by the use of feeders. The extent to which such a reduction could be carried in practice depends, however, upon the conditions surrounding each particular case.

The above losses are computed on the supposition that the motors are constantly working at their most economical rate. This is of course not true, and the additional loss arising from the arbitrary resistance interpolated to protect the motors and the losses in consequence of slow motion must be considerable.

There is also to be taken into consideration the great weight of the motor car as compared with a grip car, the difference being about 6,000 lbs.

On an electric line operating 20 cars the dead load on cars would be 120,000 lbs. more than on a cable line with same number of cars. This is about the weight of the cable, so that on such a line the claim of superiority for electricity on this account would not hold.

Of course on the electric line the dead weight for each car is carried only while the car is running which is not the case with the cable. On the other hand where there are grades the cable has the advantage of balancing itself theoretically and the cable cars on down grades help the engine, which is not the case with electricity.

I do not undertake to state what the practical merits or demerits of these several features may be.

Mr. Hasbrouck, of New York, moved a vote of thanks to Mr. McCarty for his paper, which was carried. The secretary was also instructed to have it printed and two copies sent to each member.

The meeting then adjourned until Thursday morning.

#### THURSDAY MORNING SESSION.

The convention re-assembled on Thursday morning, and was called to order at 10.30 o'clock.

On motion of Mr. Wyman, a committee of five was appointed to nominate officers for the ensuing year, and to recommend a place of meeting for the next convention.

The following gentlemen were appointed the committee:

Messrs. Wyman, of New York; Seames, of Memphis; Cronyn, of London, Canada; Littell, of Louisville, and Holmes, of Pittsburgh.

The next business in order was then announced to be the report of the committee on "Novel Schemes for the Development of Street Railways."

Mr. B. F. Owen, of Reading, Pa., read the report as follows:

#### NOVEL SCHEMES FOR THE DEVELOPMENT OF STREET RAILWAYS.

##### *The American Street Railway Association.*

GENTLEMEN:—I can scarcely hope to enlighten you, but if, in writing the history of one company in its struggle for existence it incites others to give their experience and the means taken to develop their travel, something novel may strike us as useful and good for other places. Street railway travel may be said to develop itself. Much, however, can be done to assist,

especially in cities where a regular line of coaches did not precede the street railway.

It has been charged that these meetings are useful only to the large and prosperous companies, that the matter here presented for consideration is beyond the reach of companies in cities of less than 60,000 inhabitants. In part that is fact, but not entirely so, for the workings of the larger cities, when given here, teaches what to accept and what to reject. The experiments in the use of new appliances can only with safety be made by the strong companies, the weak must wait and learn from their success or failure. This paper speaks to the managers of railways in the smaller cities. The officers of railways in the larger cities cannot appreciate the small economies their less fortunate friends are compelled to practice to work out their problem successfully, how the principal officers work for little salary or no salary, how men are required to act as drivers, conductors and switchmen, how blacksmiths, carpenters and painters are also stable men and extra drivers, how the horse account is kept down by cheap bargains and careful nursing of broken down animals, how night and morning cars are watched so as to make one car answer for two, how special occasions are watched and cared for, how time tables are made, distributed and explained to dull ears, how the habits of the people are studied and personal solicitation made to use the cars, and active spirits persuaded to become stockholders, with the many little things looked after by those who assume to manage.

After it was demonstrated that lines on selected routes were profitable, a craze for street railway building swept the country. A few prove their necessity by returning dividends, a few built to sell suburban property accomplish their object, but by far a greater number were a disappointment to their projectors. Those built largely on bonds with fixed charges soon fell into the hands of the bondholders for a new trial, while those built on stock had a longer career and, when carefully nursed, existed until a paying travel was developed. Too many of these roads were in advance of the needs of the place. The cities were compact, the distances short, cities without suburbs or little opportunity to make them, the people, accustomed to walking, saw or felt nothing of their convenience, and regarded them only as a new means to deplete the pockets of the people; even the busy were slow to learn how much in time and more in muscle could be saved by the street car. Most roads opened with a great flourish of business, kept up for a month or more by its novelty, and then, with travel falling off, came the expedients to save the property, expenses reduced by reducing cars, this led to bankruptcy. A watch over expenses with a continuance of cars gave hope, or expenses guarded with an increase of cars. The road being there, cars only could bring in revenue, the old habit of walking, thus to be broken up, and the new habit of riding cultivated by thrusting the cars more frequently before the eyes of the people.

The misfortune was mine to be made, in 1877, an officer in one of those unfortunate roads, in a city of 40,000 population, compactly built. The road, two miles long, single track, with turnouts, and extending from the southern to the northern boundary of the city, reaching a rear entrance to a cemetery, with a branch to a steam road station on the suburbs. A frame stable and car-shed served to house 17 horses and 10 cars. The road was opened 18 months previous with 50 horses—it had the usual flattering beginning, but latterly had met its deficit by a sale of horses—the trips reduced until there were only three cars on the road collecting seven cent fares. The time table gave cars to meet trains on the steam road, and to the cemetery at long intervals. The cars for trains, when not doing that service, had irregular times over the road. The cars, on reaching the depot, remained there until the arrival of trains and it required an effort to convince that it would be better to be moving over the road at regular intervals than to be chained to the station platform. No more horses could be sold, and means to increase revenue must be found or go under.

It was soon discovered that the theory of railroading, so far as the general public is concerned, is very simple, and is: Adopt a time table with cars as frequent as possible—slightly more than the travel warrants—announce the time of running, and run them—a single failure to do so will be quoted against the company for weeks.

The fare was then considered. The odd amount was not pleasing to the public—it broke a ten cent piece. The remainder might as well go with it. Five cents, with three cents for children, was adopted, and tickets at 6 for 25 cents. The change had an immediate effect, but still the cars ran empty—passengers looked lonely, felt lonely, almost guilty when stared at by their neighbors on the sidewalk. Many of our citizens, economical in their habits, never entered the cars.

*Annual Ticket.*—A careful canvass of the patrons of the roads gave but two persons spending so much as \$15 a year in car fare. A ticket giving to one person named thereon the unlimited right to ride for one year was offered for \$12. A few were sold. The object was not the money that was in the ticket, but to have people on the cars. He did not desire to issue free tickets for that purpose. The man who rides free is not your defender. The price was reduced to \$10, with a greater sale, and holders urged to use the cars frequently to give an appearance of business. The numbers increased and the price raised to \$15—then to \$25, and finally to make a market for a life ticket, abolished. It had served a good purpose—we gave it a regretful goodbye.

*Monthly Ticket.*—The annual tickets met the wants of one class. Workingmen required something with less investment, and there was issued about the same time a

monthly ticket, dating from the first of the month, giving unlimited rides for a month at \$1. Within a year the sale reached an inconvenient number, and the price was raised to \$1.25—then to \$1.50. Their sale was still too great, but, as the ticket was useful to workingmen, it was limited to certain hours on working days only, and finally the rides were limited—the ticket standing to-day four rides for each working day in the month—good until 8 a. m., 11 to 2, and 4 to 7 p. m., not good on Sundays or holidays. It makes a ride cost 1½ cents. Passengers cannot be carried at that price, but it paid our company well. It taught to ride—it made it possible for workingmen and others to live long distances from the centre—it encouraged building on the outskirts—it made outlying property more valuable. The workingman taught to ride to his work, used the cars freely on Sundays and holidays, taking wife and children with him. His companions without monthlies followed his example and paid five cents. The wives soon used the cars to market and the stores, with occasional trips to the cemetery or park.

*Coupon Tickets.*—Five cents is an ideal fare, but in our compact city short distance travel was very limited, and we conceived it might be increased if a ticket at a lower rate could be offered those frequently on the street. That the ticket would be used for long rides as well as short ones we considered would be balanced by the greater number of rides taken, and thus attain the main object—the cultivation of the riding spirit. A Coupon Ticket with 30 rides was offered for \$1. To avoid an outside sale simply, these tickets are bound in a book to be detached only by conductors. The ticket steadily gained favor until at this time fully 30 per cent. of the gross receipts of the company come from its sale. With the dollar paid, and tickets in hand, it seems not too costly to take the cars. The tickets are purchased because they are cheap, and used because they have them.

*Life Ticket.*—The road had reached a paying basis, when, to meet the competition of a rival company, a station was opened by the steam road in the centre of the city. Our loss was fully 25 per cent. of gross receipts. At the same time the Cemetery Company gave notice that the rear entrance, granted at the opening of the road, was to be regarded as a temporary grant to be terminated, and that entrance closed at an early date. Only those by car entered the rear. Three-fourths of all who entered or left the cemetery grounds used the front entrance—all of whom walked. To recover our loss the company resolved to reach the front. This change required the building of a half mile of track, with curves and turnouts over a route not yet graded. With stock below par, and the road mortgaged two years before to build a stable, we had nothing left to bond, and could not sell stock. It was decided that as property on the new line would be enhanced in value by the change, property should bear the expense of it. A Life Ticket was offered to all who contributed \$300 for the purpose—the company offering to build if the amount were raised. The receipt for the money made the ticket transferable but not redeemable for the first five years, and redeemable, but not transferable after that date—the ticket to carry one person named on its face. The money was raised and the extension made. The new branch added to the receipts more than was lost of the depot travel, and the holders of the tickets were more than pleased with their bargain—their property at once found ready sale at lot prices, and the tickets have since changed hands at \$400.

*Other Extensions.*—The success in that venture proved two things—that property-holders if fairly approached would pay for extensions, and that extensions were necessary to make the older portions of the road profitable. Acting on this, other extensions were mapped out, and new schemes adopted for raising the money. A route to a pleasure resort at the other side of the city was selected for the next effort. A five per cent bond, interest payable in tickets, 24 for one dollar, was offered to owners of property along the line, and after a little persuasion, taken. Two-thirds of this was in \$500 bonds which gave the option of a personal Life-Ticket, or interest in tickets. The branch was built, the bonds issued, and interest paid in advance for one year. The whole district was flooded with tickets—the cars filled with people—the tickets were good only to be used and used they were. Those receiving them treated their friends, and their friends continued to ride and paid fare. Within two months every ticket was back into the hands of the company. This scheme, and this extension proved the best ever attempted. It started a travel far beyond the expectations of the company, and created a demand for stock above par among those who a month previous refused it at less than par. The added mile and a half made a long ride, and there were many who took the long ride for pleasure who soon from habit used the cars for shorter distances. The redemption of this loan will give the company no trouble—it still has several years to run, and already the \$500 bond is sold for its Life Ticket quality, and a resolution of the board exchanging the \$100 bond for a ticket good for one person for four years, is rapidly gathering them into the hands of the company.

Encouraged by the success in having property pay for extensions, a more ambitious venture was next planned, and in a fair way to success, when a rival street railway company, alarmed at the attack on their territory, announced their intention to extend it in the direction proposed, and without asking property to contribute. Their card won, but after that it was a continual strife for new franchises, until the city became a net work of tracks, all built on a scale of stock, with stock advancing in the market. To secure a rest our company purchased the franchises of the other company. This gave us possession of the entire city, and an opportunity to rearrange the routes of travel to better advantage. It did not stop

(Continued on page 191.)



# The Street Railway Gazette.

S. L. K. MONROE, - - - - - MANAGER.  
E. V. CAVELL, - - - - - EDITOR.  
EDWARD J. LAWLESS, - - - ASSOCIATE EDITOR.  
W. L. S. BAYLEY, - - - - - MECHANICAL EXPERT.

## GENERAL OFFICES:

### CHICAGO:

8 LAKESIDE BUILDING.

AGENCIES } San Francisco, - - - 1222 Bush Street.  
} Toronto (Canada), - - 53 Magill Street.  
Cable Address=TRAM, CHICAGO.

Annual Subscription (Including Postage).	Per Copy
United States, Canada.....	\$2.00. .... 25c.
Great Britain, Ireland, India, Australia 10s.....	1s.
Germany.....	9mk. 75 pf. .... 89pf.
France, Belgium, Switzerland.....	21fr. 95c. .... Fr 1.10.
Spain.....	21ps. 95c. .... Ps 1.10.
Austria, Holland.....	6ft. 74c. .... 55c.
Italy.....	12 lire. .... 1½ lra.
Venezuela.....	12 bolivars. .... 1½ bol.
Mexico.....	\$3.00. .... 30c.

Annual Subscriptions in Argentine Republic, 2½ peso; Brazil, milreals; Turkey, 54 plasters.

[Entered at the Chicago post-office as second-class matter.]

\*\*\*

Matter for publication should reach the Chicago Office not later than the last day of each month. All communications should be addressed, THE STREET RAILWAY GAZETTE, Chicago, Ill.

## ANNOUNCEMENT.

O. S. T. A.

The Annual Convention of The Ohio State Tramway Association will be held at the Neil House, Columbus, O., on Wednesday November 19th.

Secretary Lang is hard at work arranging for the reading of some valuable papers, and it is expected that the attendance will far exceed in numbers that of last year.

We understand that it is the intention of quite a number of supply men to exhibit their goods and have a personal representation at the convention, and present indications lead us to believe that the meeting will be the most successful ever held.

### The Buffalo Convention.

Now that the ninth annual convention of the American Street Railway Association has passed into history, and the smoke of the battle has blown away, we feel no hesitation in saying that, taken all in all, it was by long odds the most instructive, harmonious and successful convention that the Association has ever held.

As was to be expected, electricity was on top, and the delegates, one and all, seemed to vie with each other as to who should take home the greatest amount of electrical information. Looking back, in retrospect, from the history of the association, from its inception in 1882, we cannot but feel that some of the gentleman who have been persistent attendants at the various conventions must occasionally think that they are existing upon some other planet, and one where the prediction of old Mother Shipton has, thanks to the enterprise and indefatigability of electric railway promoters, and manufacturers of electric railway apparatus, being amply verified that

"Carriages without horses shall go."

It has been both our duty and pleasure to be present at each of the conventions held by the American Street Railway Association, with the exception of the first one held in Boston in 1882, and it is with feelings of the utmost gratification that we note the steady evolution from animal

to mechanical traction. At the Boston convention in 1882, the word "Electricity" was hardly known, and the same may be said with regard to the Chicago convention of 1883, the New York of 1884, and the St. Louis of 1885; at both the St. Louis and Cincinnati conventions (the latter being held in 1886), the cable system was in the ascendancy, but the revolution commenced at the Philadelphia convention of 1887, when Mr. William Wharton, Jr., of that city, exhibited his storage battery system, and set the members' delegates thinking that perhaps, after all, electricity was the coming motive power.

From that time on electricity has been steadily creeping to the front until it has now received the unqualified endorsement of at least 25 per cent. of the street railway companies in the United States.

In view of all this; in view of the tremendous boom that electric traction is receiving; in view of it being the absorbing topic at all street railway conventions now, we venture to predict that, within less than two years, animal traction will receive little, if any, attention at the hands of street railway men in convention assembled. That the convention recently held in Buffalo was a tremendous success is evidenced by the immense attendance there—both of delegates and supply men; and there is every reason to believe that even this large attendance will be vastly enhanced in numbers at the Pittsburgh convention of 1891.

### The New President.

It is eminently right and proper that those who do the most work should receive an adequate reward, and in the election of Col. Henry M. Watson, of Buffalo, to the Presidency of the American Street Railway Association, an honor has been conferred where honor, indeed, is due.

Col. Watson has been an earnest advocate of the interests of the A. S. R. A. since its inception, and we venture to state that no single member thereof has done more for its welfare, or worked harder for its advancement than has the gentleman upon whom its presidency has now been conferred.

In tendering our congratulations to Col. Watson upon his attaining the highest office within the gift of the association, THE GAZETTE also takes occasion to congratulate the A. S. R. A. upon having at its head an officer so well qualified for the position, and one who will always sacrifice his own personal interest to the general weal.

### The Social Side.

From time to time we have heard the argument advanced that the street railway association's conventions are nothing more or less than a "general junketing" etc., but we, in the light of many years' personal experience, cannot, by any means, endorse the sentiment. On the other hand, we not only "deny the allegation," but also "defy the alligator" to substantiate the truth of the statement. That the social features of a convention tend largely to draw members of the same together, cannot reasonably be denied, and the admission of ladies to the annual banquets has been to a great extent, a material gain to the convention in every desirable way.

It is a generally conceded fact that the presence of ladies at a convention tends not only to increase the interest in the convention, but wherever the ladies go afterwards, they talk up the association and make their influence felt, thus insuring, indirectly, an increased membership.

Their presence at the conventions is indeed a welcome one, and not only is it a most graceful compliment to the attending delegates, but the refining influence they exert is one that cannot be overestimated.

Therefore do we most heartily endorse the social side of the conventions, and do not hesitate to express the opinion that it has always been, and must ever be prolific of naught but good—adding as it does enjoyment to the delegates, and credit to the association.

### Constitutional Changes.

In a recent number of one of our exchanges we notice that exception is taken in some measure to the action of a certain association in convention assembled for its action in making frequent changes in its constitution, and the exception thus taken appears to us to be both unreasonable and illogical. If an association finds, after a due consideration of the matter, that its condition can be bettered by changing or modifying the rules and regulations governing it, what is there unreasonable in that they take such action as will bring it to a higher state of prosperity?

It is a matter of absolute impossibility for any association—e'en tho' it be governed by the wisest Solons in the world—to enact a code of by-laws and to create a constitution at any one meeting, which shall redound in every way to its prosperity, and fulfill all its requirements at any one meeting.

Ridiculous, then, it is for exception to be taken to even annual constitutional changes. The world moves, and many, many matters tend to render it imperatively necessary for legislative changes to be enacted, and any association that would hesitate to make such changes, on account of a general impression that it showed itself to be an "uncertain and fickle quantity" by so doing would be regarded by a majority of level-headed men as away behind the age.

### "Civilized Motors."

Regarding the Rae motor, which was recently put in operation on the line of East Cleveland Railway company on Prospect and Euclid avenues in Cleveland, O., the Cleveland *Leader* speaks of it as "one civilized motor," on account of its silent action, and takes occasion to draw attention to the noise made by other motors in use in the city. While we are, in common with every one, in favor of silent motors, such as are now built by several electric motor companies, we can hardly agree with our esteemed contemporary, *The Leader*, that the motors, which have conveyed so many thousands of citizens to and from their homes with promptness and dispatch, can reasonably and rightfully be dubbed as "barbarous." If barbarity consists in affording rapid transit to the people of Cleveland, then indeed the motors in use there are barbarous, but *The Leader* is assured that all street railway men are anxious for a silent motor, and that every motor manufacturer is working towards the construction of a machine that shall be absolutely noiseless.

THE GAZETTE has earnestly tried to make mention of every one who attended the Buffalo Convention, but if the names of any are omitted, it is simply because they failed to leave their cards at the GAZETTE'S Convention Headquarters.



[(Continued from page 189.)

extensions, but presented a duplicate system. It did not change the rates of fare—that is fixed by the public by refusing to be patrons if the price is not satisfactory.

Five cents is an ideal fare. Expedients to build up travel are sometimes necessary, but the present manager will so guard matters in view, binding ourselves to nothing that will prevent it, but the thirty-ride ticket has become so much a part of our system that to stop its sale as yet finds no advocate in our board.

**The Stable.**—The location of the stable may sometimes determine the question of paying or non paying in street railways, while plans for increasing travel received attention, how to save expense and yet serve the public was not neglected. Our stable was not well located. The earliest work in the morning was northward, the latest at night southward. All of the work during the day started at the south end and ended there. The stable was north. The road was mortgaged and a stable built at the south end, a saving of one trip per day for every car on the road was the result. After that extra runs were more frequent, as it costs less to make them.

**Funeral Cars.**—One source of revenue for street railways has so far received but little attention. Our company from the start encouraged the use of cars for funerals. We ramify with our tracks over the entire city, and connect with all the cemeteries. Cars are chartered for the purpose, and 2, 3, 4, and as many as a dozen are used. The car makes the more satisfactory means of handling a funeral. Arrived at the entrance to cemetery, the procession forms and moves to the grave without that embarrassing wait incident to the use of carriages, where each is driven to a given point to unload. Clergymen and undertakers encourage their use, their cheapness being the only serious objection, even those who feel every item of expense hesitate at this saving at a funeral. Societies invariably use them, even when not used by the family. The members of the societies go to the house in a body, attend the services there, and then taking the cars, arrive at the cemetery in advance, are in place to receive the body on the arrival of the funeral. We have frequently thus transported the employees of large manufacturing establishments, as many as 500 at a time. Our company has never tried the experiment, but are convinced that special cars, to be used for funerals only, and at a higher charge, would add that style in their use that would commend them to classes that now refuse them. Our efforts to attract travel to the cemetery has had the effect of adding beauties to the cemetery, until it is one of the finest in the country, and is visited by greater numbers than are the cemeteries of cities of double our population.

**The Park.**—Summer travel has always received our special attention, as on it was based our greatest hopes. Beyond the city limits in a ravine is located our pleasure resort. It has long been the favored spot of our citizens, but never visited in such numbers as the past summer. Two of our lines were extended to it, and one afternoon and evening of each week we engaged one of our popular brass bands and added music to its attractions. Doubling the cars on both lines did not suffice to carry the thousands who filled the grounds. In the afternoon ladies and children, in the evening the young people and their escorts, so that from noon until midnight the cars ran packed. The park commissioners, not slow to take in the situation, added new attractions to the park—swings, summer houses, a music stand with seats surrounding it. With these conveniences conventions have been held there, and the improvements have invited thousands when its shades were not resounding with the strains of the brass band.

One of the best enterprises to make travel for our lines was carried through the past year. We had succeeded in working up our own home trade, and the Mt. Penn Gravity Railroad was projected to attract excursion parties and tourists to our city. On our east is Penn's Mount, rising 1,000 feet above the river—the summit not more than a mile in an air line from the centre of the city. It has always been a favorite walk for those strong enough to make the ascent, there was not even a carriage drive to the summit. A charter was obtained and a railroad built, starting from the eastern terminus of our lines. The summit is reached with a grade 5.1 per cent. The cars from the summit return by gravity on a different route, averaging 1.7 per cent. The locomotive returns by the up track. It has added largely to our travel, principally strangers, and Reading, through the exertions of the street railway company, hereafter will be a summer resort as well as a manufacturing city.

Has any one ever reflected how much habit has to do with street car riding? In small cities people are not compelled to ride—they still can walk. Our company deliberately planned to force people to ride—to make riding so cheap that it was cheaper to ride than walk—they could almost save the fare in shoe leather. With our monthly tickets we make it possible for a working-man to save in going home for dinner and not carry a kettle. We have always kept up courage by the reflection that the next generation will ride more than this.

**The Free Ticket.**—In the fourteen years of management of the lines in the city of Reading, I have been openly and entirely opposed to the free ticket—opposing the board and the constant solicitation of the thousand and one who think they are entitled to ride free—say they have benefited us thus and so—or can and will do thus and so—can harm us thus and so—or are as much entitled as some others they conceive are riding free. This opposition is determined, making it a will to give no free tickets except for service that can be acknowledged to the community. We desire to make the man using a free ticket feel independent, and be able to say he does ride free, and for service now being rendered. The mass of humanity are jealous of special privileges, and are not slow to claim the same privileges,

conceiving their claim to be equal, if not superior to those possessing them, and feel they have a grievance if denied. In giving a free ticket to one, you may be offending fifty others who otherwise would be your friends. This opposition to the free ticket is the parent of low fares on our system. You cannot be generous to the public and liberal in the distribution of free tickets. To cultivate the riding habit we offered a bait too tempting to be refused.

**Special Occasions.**—Any happening that attracts a multitude is our opportunity to make new patrons. The instructions to the superintendent for those occasions being: Provide cars—let no one walk who desires to ride—the profits for the day may be nothing—to get new patrons on the cars—everything. If they ride once they will ride again.

The following notes may be of use in cities as unfortunately situated as ourselves. If a line is short add an extension to a resort or make one at the terminus. The longer ride will be taken for pleasure. Those who commence because of much for the money, will soon use the cars for shorter distances. An extension adds value to real estate, have the owners help pay for it. People are continually urging extensions, let them show their earnestness by agreeing to take a given number of tickets and pay for them in advance. Listen to the suggestions of all who come to you for that purpose, if good adopt them, it makes talkers for you, they will claim the new idea as their own, encourage that, your aim is to get travel, not a reputation for smartness. If a resort be on your line, advertise it. If a cemetery, have the papers call attention to every new monument erected, that will add visitors. Soon lot owners, seeing the many visitors, beautify their lots which add more visitors, and as to be able in the end to reach that ideal, we have kept steadily improving more lots. The cemetery becomes one of the attractions for strangers.

Life and annual tickets, coupon tickets and monthly tickets may be good, but regard them only as temporary expedients, to be abandoned when travel is established. Keep the cars clean—have the drivers and conductors be attentive and polite—allow no disputes with unreasonable passengers—all others on the car take sides against the company. Keep the public with you by keeping them interested. Have every new move given to the papers. People are curious in small places, and will go out of their way even to see the digging of a cellar. If a foot of ground be opened for sale at the end of your line, have your stockholders talk it up, remembering that a new house is worth to you from \$25 to \$50 per year in car fare. It is not alone the new comers, but their friends from their old quarters that become your patrons. Do not hesitate at extensions a little in advance of buildings—those who follow you do so because you are there—those who preceded you have learned to walk—it takes time to destroy that bad habit. To develop travel make it possible to reach with cars every portion of the city. One single line is not sufficient. If from a given point you are compelled to walk in three directions and can ride but one, you are likely to walk that also. The opportunity creates travel. The immense sale of beer comes from a saloon on every corner with an intermediate place to rest. Be liberal with the public—make transfers when you can without making a circuit returning to the starting point.

The fare is always a problem. It is better to have cars filled at three cents than empty at five. Tickets purchased at low rates must not be separated and sold singly. Tickets 30 for \$1.00 will give you a dollar quicker than a five cent fare, and those who hold them seem anxious to realize on their investment. Your problem is how to get the most from each person in a year, and not for a single ride. The great public are disposed to purchase unlimited quantities of an article if it be cheap. Five cents seems to be a maximum fare—too many deem it also the minimum—it by no means follows, the army of smokers did not learn on cigars at five cents each. If the city is compact, it is not certain that it would be a mistake to reduce the price of tickets to three or even two cents to entice passengers on the cars. The investment is made, it is permanent. To get your people into the habit of riding low fares may be necessary. Regard it as good advertising, and look to the future for profit. After the habit is acquired they will pay five cents. With fair management an annual increase of 10 per cent. on gross receipts may be expected, while expenses should not increase more than five. Ours may not be the most profitable business, but it is reasonably certain. Its managers are the ready target for the press when other game is scarce, but they can have the proud satisfaction that nothing so livens up a dead city as the street railway, nor is any American city complete without them.

**The Stable.**—So locate the stable that every car reaches it on each trip—let the point of changing horses be where distance is least between stall and car. If a branch is added, it is better to build a stable for it, if the cars do not come naturally to your first stable. If it costs more in labor to carry your horses for changing on a branch line than the interest on the cost of stable, build the stable. Formerly ten miles was considered not too great a distance for a horse to travel on a trip, but with the increased speed demanded by the public I would regard seven miles as the utmost limit.

There being no remarks on the report, it was ordered received, and placed on file, and published in the minutes.

The President.—The next paper is that on "Public and State Treatment of Corporations No. 2," by G. Hilton Scribner, of New York. Mr. Wyman, Vice-President of the road of which Mr. Scribner is President, will read the paper.

Mr. Wyman.—Mr. Scribner wishes me to present his regrets that by reason of other duties he is not able to be present here at this session and read to you in person his paper, and also to listen, and possibly, to participate in any discussion regarding it which might arise.

Mr. Wyman then read the paper, as follows:

#### PUBLIC AND STATE TREATMENT OF CORPORATIONS.

By G. Hilton Scribner.

A year ago, when it was my pleasure, by reason of appointment, to present a paper before this Association upon this topic, attention was called to many of the special and unjust burdens imposed upon Corporations by the public and the state, and so this paper may prove, although written from a different point of view, a repetition in part of the conclusions then reached.

But the ill treatment of Corporations is also repeated with every session of Legislature and Courts, with each issue of press and political platform, and therefore continual protest upon our part, though that protest shall often but rehearse the story of kindred and like wrongs inflicted and borne before, cannot be amiss.

Petition and protest, patient and persistent, has often secured a hearing and effected a removal of undesired political or social disabilities, and so to review again some of the facts and considerations which in substance have already been considered, can do no harm.

But aside from the fact that it is our duty always to complain in indignant yet dignified terms against unjust and iniquitous treatment at the hands of the public and state, it certainly should be a matter of anxious thought and investigation on our part to discover toward what result the present trend of public opinion and usage of corporations are leading and what is likely to be the end so far as the use and control of their property is concerned, unless a change of sentiment and action regarding them is effected.

It is no longer a contention with intelligent people whether corporations are required to pay higher taxes and bear more public burdens in proportion to their property or to the protection and benefits received than private individuals. It is no longer a debatable issue with any class of persons, intelligent or otherwise, that in a dispute between a corporation and an individual before a jury the corporation without regard to the merits of the case is bound to be beaten if the court does not interfere for its protection.

No one can longer doubt that before Congress, the State Legislatures, and even more conspicuously before the local authorities of municipalities, all corporations not only stand at a disadvantage in securing that legal protection which the individual may obtain without asking, but they are more than ever before in constant danger of being preyed upon in every conceivable way by these legal guardians of the public weal under whose enactments every corporation has at some time and in some way come into existence.

No man of observation and experience will longer deny that to be prominently and officially connected with corporations either in ownership or management constitutes a constant and strong element of ineligibility on the part of any otherwise fit man for an elective public office.

Now nothing can be more evident, upon a moment's reflection, than that corporations of all kinds are but associations of a number of citizens to do what cannot so well be done by one, or a smaller number of persons, and that the state in all cases has been the earliest discoverer of the utility of these associations, and the promoter of these combined efforts in all these departments of industrial economy in which they have been authorized to act and into which they have been by the state first invited.

It is undoubtedly true that even in this age of the world and under the most potent influences of our best civilizations, selfishness still remains a stronger impulse and motive than a sense of justice with that majority of the people which in this country have the right to rule.

It is therefore quite useless to appeal to the sense of justice of either the courts, the legislatures, the press or the public in pleading the cause of corporate rights or in any attempt to relieve those whose property and industry are involved in corporate undertakings, from the injustice and imposition which is constantly and everywhere inflicted upon them.

So long as those large classes which embrace in their combined membership all the learned professions—also the agriculturalists, the artisans, trades people, all wage earners and indeed all who live by industrial work and enterprise (who constitute the majority in almost every community) believe that their interests and welfare as individuals and classes may be promoted by preying upon corporations, so long will those who live by corporate industries and investments suffer all the undesired ills of unequal taxation and legislative injustice which are now being visited upon them.

If the fact were clearly demonstrated that it is no more detrimental for those whose industry and capital are invested in corporate undertakings to be thrifty and prosper or even to become wealthy than it would be for them to reach the same condition by individual effort, then, of course, the classes above referred to might perhaps in time be made to see that they were not, after all conserving their own best interest by indulging in so much prejudice against corporations or allowing their cupidity with so slight an admixture of justice or a sense of right to characterize and control their dealings with them. It is true that these classes whose interest in corporations is really and only parasitical always provide themselves with what they hold to be fit excuses for their views and conduct.

One of the most common and at the same time fallacious excuses for placing inordinate burdens and restric-



tions upon corporations is the allegation that the corporation enjoys valuable franchises and exceptional chartered privileges for which it has given no adequate consideration. That it has a wide scope of some kind of authority and at the same time little or no competition. In other words, that it is a monopoly clothed with unusual powers taken from the people. All of these assumptions are unfounded and false.

Let us for a moment examine one of the most frequent charges, indeed it is about the only charge, which those who are prejudiced against corporations put forward to fortify others and justify themselves in their depredations upon them.

It is claimed for instance that railroad companies exercise the right of eminent domain in establishing and securing their rights of way under the proceedings for the condemnation of land. Now, nothing could be further from the truth. In the first place, the state itself under its own organic law or constitution can only exercise the right of eminent domain against the vested rights of any citizen when it is found to be necessary to take private property for public uses. But public uses are necessarily its own uses—neither more nor less.

The state is the organized public. Moreover, private property can not be taken by the state even for its own public uses except by giving a full compensation therefor. In the case of railroad corporations and all others where the right of eminent domain is exercised, the state takes the land for its own advantage while the corporation pays for it, and in return only receives an easement or right to use it for certain specified purposes. The railroad company loses even this limited claim upon it when it ceases to so use it and it reverts without payment to the original owner of the fee. So in no sense, does the railroad company exercise the right of eminent domain. The state, on the contrary, does exercise it for its own benefit and purposes while the company pays whatever the state shall determine, to the owners whose occupancy has been thus disturbed by the state itself for the necessities of the public.

The courts have held, it is true, that in the cases of quasi public corporations the company is in some sense the other agent of the state in the taking of land and in exercising some of its functions, but this is a confession, so far as it goes, that the state is the principal in all cases and is in perfect accord with the doctrine here urged, that in all cases where the right of eminent domain is exercised, it is exercised by the state, and in the interest of the public, and in no sense and to no extent in the interest of the corporation as such.

The only act which the company does, which would have the semblance of actual ownership in the premises, is that it pays the owner the full value of an absolute title in fee for that which the state has taken in its own behalf, while in return the company only acquires an easement, and that forever after the company pays taxes upon the same annually at an assessed valuation much higher than is assessed upon any other land in the neighborhood which is still held in fee.

What is true of steam railroad companies in this respect is also true of street railroad companies.

No street railroad company acquires any property in the street itself, but only a right to use the street in a manner which in the opinion of the legislature will best conserve the interests of the public, which is in fact the state. In other words, the company simply acquires the right to use the street for that particular purpose, and no other, for which, in the judgment of the State the street was originally opened and dedicated.

This is a right which the individuals composing the public have without special permission and thus which belongs to the whole public. So when the organized public or state authorizes a certain number of its members to lay down railroad tracks in the public streets for the transportation of passengers at a fixed rate of fare, and under many restrictions and special obligations, all duly set forth as conditions precedent to the occupation of the streets, and the operation of the railroad therein, it is only fair and reasonable to suppose that the public, or state, has consulted only its own interests in making the proposition, and likewise that those individuals constituting the company in accepting the offer have been moved to do so by a similar motive. It is therefore not only sheer nonsense but unfair and even positively dishonest on the part of the public, or state, to demand of the company afterwards anything not named in the charter or to impose any new burden upon the company upon the ground that the public has parted with something which it once owned when neither, as matter of fact or law, has it parted with anything whatever, and would not be justified in breaking its bargains even if it had parted with something extremely valuable.

In no civilized country could any individual under the laws and usages thereof so deal with another.

It has been reserved to the American people under republican forms of government to "eat its cake and keep it too," in dealing with those modern associations of industry and capital called corporations, and which have done more, by the way, to develop the resources of the country than all other causes combined.

In all the multiplicity of defences of the individual, both as to personal and proprietary rights embodied in the constitution of the State of New York, there is not one word of command or suggestion that taxes should be equal or uniform. The legislature may, if it chooses, under and by authority of the constitution, place the entire burden of the state, and even of counties, towns and municipalities upon those whose property is managed by corporations.

He must be a very careless observer of the drift of public opinion and of legislative policy for the last few years who has not discovered that this very thing is now in course of accomplishment.

As before stated, the specious and unfounded excuse

for this condition of things put forth daily by the press, and thoroughly believed in by the general public, is that corporations of all kinds enjoy special privileges which places them under eternal obligations to the state and to the public, in other words, under a never ending obligation to everyone who is not interested in them except in this parasitical way.

Let us examine for a moment and see if possible whether there is any truth whatever in this pretended excuse, which, if it were sound in fact would not, as has been shown, justify the state or public under any circumstances in dealing with corporate property or the persons who own it on any different basis from that assumed in dealing with individuals and their interests.

Remember that the question is, whether corporations enjoy by virtue of law any exceptional privileges?

To bring to a focus at once all the factors and considerations bearing upon the solution of this question without a long argument, backed by a still more tedious recital of examples and details, let us ask whether corporations would gain or lose by the enactment of a law declaring that the scope of all corporate rights and liabilities shall hereafter be extended and restricted to whatever citizens may legally do.

Such a law would give to the corporation the right to hold whatever property it chose to acquire and to have it treated and taxed by the state as individual property is treated and taxed. It would give the corporation the right to conduct its business affairs without inspection or supervision. It would give it the right to engage in any industry it chose and to carry it on wherever it should find it most convenient to do so. It would give it the right to keep its own affairs to itself instead of spreading them upon public records, and publishing a great part of them in the public newspapers. It would give the corporation the right to make its business as profitable, without question, as thousands of able business men have made theirs, to say nothing of the right to vote, hold office, and be represented in the Legislature.

There are hundreds of limitations beside hedging the actions of the corporation on every hand to which the private citizen is an absolute stranger in his business life.

It is true that citizens as such cannot under existing law issue money nor secure by law an easement for the purposes of railroading.

But all citizens who choose may at any time and any where do these and all other things which any corporation may do by combining pursuant to general laws, their efforts and capital for such purposes.

There is but one great monopoly either in property or authority in this country, and this is the privilege and franchise of those who have no invested interest in corporations, and who constitute the majority to tax the property and restrict the actions of those whose property is employed through corporations without limit and thus protect their own lands and goods from public burdens and their own business from competition by this unjust imposition upon the property and business of others.

In several states corporate property now pays the entire state tax, leaving all other property free and clear of this great annual burden.

In all the states corporate property is excessively and unjustly taxed, and the business and affairs of all corporations are subjected to visitation, inspection and restriction by state and municipal authority in a manner and to an extent which is unfair in most cases, and in others simply outrageous.

It is not true then, in any sense, that a corporation is an association of persons enjoying exceptional privileges and exemptions as compared with individuals—on the contrary, it is an association authorized by law for some specific purpose which has been recognized and approved by the state but with abridged rights, limited scope, restrained activities and increased liabilities and control as compared with those of the citizen.

What reason or justice or decency is there then in maintaining two systems of taxation, one for corporate and another for individual property.

When a corporation has paid taxes at the current percentage for the year upon all its real, and stands ready to pay upon all its personal estate, why should its capital stock be assessed and taxed. Why should it pay still other license fees, assessments and additional taxes based upon its earnings gross and net. By this unjust method of stock assessment the Railroad Company is compelled to pay an annual tax upon the good will or prospects of its business and which is assessed, usually, at three or four times the value of all the personal property it owns. One instance is as good as another in showing to what extent Street Railroad Companies are imposed upon in this matter of taxation.

The rate for the last year in the City of New York for city, county and state tax on personal property was 1.686, or a little less than 1½ per cent. Not one person in a hundred liable for personal taxes, paid, even at this low rate, anything whatever, and the hundredth one, it is safe to say, did not pay on one hundredth part of his personal estate.

Now one Street Railroad Company owning but \$344,000 of personal estate all told paid beside its real estate tax \$38,000 which is a little more than eleven per cent, in one year upon its entire personal property not estimated at a low valuation, but computed at cost, without any allowance for wear and depreciation.

All other companies in New York paid at about the same rate without any deduction for indebtedness, bonded or otherwise. Why should a hundred or more bills be introduced at each session of the State Legislature all intended to the best of the ability and ingenuity of their authors to injure or annoy corporations in the transaction of their business beside those intended to shift additional burdens from individual to

corporate property the first of which are never criticised by the public or the press while the latter are always greeted with commendation, and applause.

Before courts and juries corporations in dispute with a citizen have come to be dealt with so unjustly that as a rule they find it less oppressive to appeal to their adversaries and abide by their judgment stimulated and warped as it must be by cupidity, than go before these tribunals of professed impartiality.

During the last year a case for a trifling injury to the person was tried in the Superior Court of the City of New York in which the corporation with which the writer is connected was the defendant. The jury seemed intelligent, the judge ruled fairly and the case was on both sides well presented. To the astonishment of both parties, the jury after a short deliberation brought in a verdict for \$5,000, which, however, was settled the next day for \$2,000—all parties concerned well knowing that in this case at least the jury had committed an act under the forms of law for which every one of them should have been fined the full amount of the verdict, had they lacked the legal protection of jurors or acted from a less excusable motive than unfounded prejudice.

This course of treatment of corporations by the public and the press, the Legislature and the courts can in the nature of things have but one ending if continued long enough. Corporations will at last, one and all surrender or sell to the state upon such terms as a venal legislature may offer, the various industries which can no longer with profit be carried on in opposition to its interferences and under the increasing burdens and oppressions which by striking bills and otherwise it has placed upon them.

It is even now the constant appeal of all labor unions, that the state shall take not only into its control but ownership, all quasi public corporations. Nor is their course in this respect illogical, for public ownership and management would not only open to them the most direct avenue to corporate property and earnings but it would prove a long stride toward the distribution of all wealth, and render the dream of the socialist a possibility.

Our free schools, free press and that exhaustive discussion of all public questions preceding the frequent elections under a democratic form of government, has at last taught all classes, including laborers, in this country what their material interests are. They are fully instructed, not only as to their physical wants, but how to supply them.

Now large numbers of persons, bound together by avocations and associations and which we call classes, have always, without exception, in all countries and in all ages since the dawn of history, regarded their wants and their rights as synonymous, and such will be the rule in the present case.

To-day, the world over, and in this country more than any other, labor and capital, the former willingly, and the latter under the lash, are on a dead run for the same goal. And this goal, this consummation, ignore it as we may, call it what we will, disguise it as we please, is no other, in fact, than absolute state management. And state management is neither more nor less than state socialism of the German type. To-day a very simple and evident truth is flashed over the Vanderbilt system "that to be a Knight of Labor is inconsistent with the duty of a railroad employe," and the chosen chieftain of the laborer screams back from Scranton, "to-morrow the government shall own and manage all your corporations." Here you have the very gist of the labor question. In its last analysis, it is a question of control. This, and this only, is in dispute between labor and capital. It is an "irrepressible conflict" between two great classes, as to which shall possess and control what labor has produced, and is producing. Now if any one can tell which is the most numerous class, those who have control or those who want it, the ins and outs in ownership, it will not be difficult to determine which class, stimulated by eager politicians, will ultimately carry the elections and control the government.

Conservatism, it is true, usually comes with responsibility, but it is only a conservatism in dealing with the disputes of others, after self interest has been fully satisfied.

Whatever may be said against Mr. Powderly's proposition, that a government, to be controlled by him and his followers, and which by that time will be his and their government, shall seize the corporations for their own benefit, it must be admitted that he is simply and only following to its logical conclusion the theory and practice which the present government has already inaugurated, that of treating the property belonging to one class of citizens differently from that belonging to another.

Those who think themselves Mr. Powderly's betters, in morals and in many other ways, say boldly let us prey upon corporate earnings by every means in our power, and Powderly says, let us seize the entire plant, and so take all their earnings.

The doctrines proclaimed by the press, the pulpit and the bar, taught in the counting house, the shop and the field, enacted by the Legislature, enforced by the court and confirmed by the jury, is that corporate earnings may be seized and taken by unjust and unequal assessments, taxes and judgments, and in many other ways simply because they are corporate earnings for the comfort, uses and relief of those who have no proprietary interest in them. Now, to do this, is not one whit more commendable than to follow Mr. Powderly to the logical consummation he announces, that is of taking the whole, while it is as much meaner than his method, as petty larceny is more contemptible than grand. It is, beside, more aggravating.

Those who maintain the right of legal forage upon property not their own through unequal taxation interferences and restrictions, not only violate their own professions, but seek flimsy excuses for their course and try to shut their own eyes to the fact that they are con-



stantly doing in a retail way what Mr. Powderly proposes shall be done at wholesale.

Is it to be supposed that either class will succeed in a peaceful and lasting transfer from other pockets to their own without compensation? Can such systems be firmly established and maintained in America and revolution avoided? There is not the slightest probability of it.

The age has past (if there ever was one), when injustice and oppression in any form can be systematically practiced by one large class of society upon another of the same race, with any result but that of final disaster and ruin to those who expect to profit by it.

When corporations are taken by the state, no one else will want them on the same terms, and the carnival of the public, while in possession, will be brief and unsatisfactory.

It is an unpleasant task to sound a note of warning and generally an unwelcome one, but he lacks sagacity, not less than courage who seeks to hide an evident future, or hesitates to look any unpleasant prospect in the face.

It is possible that a fortunate and timely change in public views and sentiments may yet turn back the tide of confiscation and distribution, which has been already begun.

It is possible that statutes may be repealed, ordinances rescinded, and decisions reversed, so that the property of one class shall no longer be seized upon for the benefit of another, but is it probable?

He must be an optimist, indeed, who can discover in the present attitude of the legislatures or the courts, the press or the public, anything which is prophetic of such a just and desirable consummation.

On motion of Mr. Littell the paper was ordered to be received and placed on file, and copies printed, five of which were to be sent to each member.

Mr. Richardson moved that the representatives of the different electrical systems who were in Buffalo be invited to address the meeting. The motion was carried, and a committee appointed to make the announcement to the gentlemen indicated.

On motion, each representative was allowed fifteen minutes in which to describe his system.

Mr. D. H. Bates, Vice-president of the Accumulator company, took the floor, and after thanking the Association for the opportunity given him for presenting the subject, read the following paper on storage battery street cars:

THE EDCO STORAGE BATTERY STREET CAR.

The horse is a noble and extremely useful animal but he seldom combines high speed with great endurance. The fast trotter is made to run his mile in from two and a quarter to three minutes, but he does it only on rare occasions, and is well fed and cared for between times.

It was not until yesterday when Mr. Odell's very interesting paper was read that I had any idea of the innumerable obstacles to be surmounted in first securing a perfect street car horse, and second in maintaining him in a constantly efficient condition.

Judging from the expressions of a large number of street car men with whom I have talked on the subject of storage battery cars, I have inferred that your street car horse was ready for continuous hard work at all hours of the day or night. That it took no time to change horses at the end of a trip, and that you only fed them at night after a sixty mile run, and that oats and hay were always cheap.

For all of these or like requirements must be met with in our storage batteries if they are to satisfy the average street car official.

But when we undertake to show that the energy requisite to propel a sixteen foot car with its average load of passengers at the horse car rate of speed must be increased one hundred per cent. if the speed be doubled and that the cost of producing that increased energy by whatever means you employ must necessarily be doubled, the scientific fact is perhaps admitted, but if storage batteries are the medium it is always taken for granted that they ought to do double the service at half the cost.

The overhead systems in operation throughout the country have demonstrated to you, gentlemen, the fact that electricity is not the coming power but the power already come. The mileage of street roads in the United States which in June, 1890, were operated electrically is, according to the eleventh census, eight and twenty-six one hundredths per cent of the entire mileage, but omitting fifty-nine cities the proportion runs up to twenty-five per cent. This means one of two things, either that as a rule the authorities of our large cities will not allow overhead poles in the street, or that street car managers prefer to await the result from the use of the electric system on a small scale in the towns and small cities before introducing it in the cities on a scale of greater magnitude.

The over-head systems already introduced in many places have so far improved upon the horse and mule that the public once given rapid transit would not go back to slower methods and are clamoring everywhere for such facilities.

You street car owners and representatives however, must look at the resultant in the matter of cost per car mile and net profits and before some of you yield to the loud demands of the public for rapid transit by adopting the overhead system, we beg of you to carefully consider the merits of the storage battery.

1. It will propel a car just as fast and just as efficiently with all that that implies as the trolley system. Every word that can be said in favor of the trolley system applies equally to the storage battery.

A storage battery car is capable of much work that a trolley car can not accomplish.

a. Storage battery cars can be introduced gradually, one or two at a time in connection with horse cars, cable cars or trolley cars.

We have already had proposals from a cable road for a few cars to be run at night when the cable could only run at a great proportionate expense, and from a trolley road where an extension was needed on a route that did not permit of trolley poles.

b. Storage battery cars can be run over any track or route where a horse car can be run, thus avoiding blocks in cases of fires, processions and other obstructions.

Transfers of cars can with this system be made from one road or route to another in cases of necessity or convenience in handling an unusual traffic.

c. In cases of break down at power station during hours of heavy traffic, storage battery cars could be run for two or three hours with the thirty-three and one-third per cent reserve always remaining in the double sets of batteries.

Now, as to the figures relating to the battery system.

What is the cost of a storage battery car plant?

What does it cost per car mile to maintain?

What does it cost per car mile to operate?

Let us take a unit of fifty cars:

Fifty cars at \$1,000 = \$50,000. Storage plant engine, nominally 500 h. p. (triple expansion) \$12,500. 500 nominal h. p. boilers, fifty per cent margin, \$10,000. 50 sets of car motor equipments, each consisting of two 15 h. p. slow speed motors capable of being exerted up to 20 h. p. each, for brief periods with dust-tight covers, gearing and motors running in oil, starting, regulating, reversing and speed, switches, lamps, signals, batteries etc., complete \$249,400.

Central station equipment including dynamos, rheostats, switches, reserve batteries, shifting appliances etc., complete, \$128,400.

Grand total, \$450,300 = say \$9,000 per car for everything except buildings, road-bed and tracks.

Maintenance Per Annum.

Steam plant, 10 per cent.....	\$ 2,250.00
Cars, 10 per cent.....	5,000.00
Electric plant, exclusive of batteries, 10 per cent.....	21,500.00
Batteries, 20 per cent.....	31,680.00
Shifting appliances, 5 per cent.....	200.00

Total maintenance per annum, \$60,630.00

Maintenance per car per annum.....	\$1,212.00
Maintenance per car day.....	3.32

Maintenance per car mile (on basis of 120 miles per day) 2 3/4 cents. With a smaller run the wear and tear would of course be reduced.

Data Re-Power Plant and Cost.

Horse power required.....	500
Time required for producing such power.....	18 hours
Total horse power hours.....	9000 hours
Coal per horse power with triple expansion engine.....	2 lbs
Coal per day.....	18,000
Or.....	9 short tons
Coal being estimated at \$3.00.....	\$27.00

Labor.

One Chief Engineer.....	\$4.00
Two Assistants at \$2.50.....	5.00
Two Firemen at \$2.00.....	4.00
Two Assistants at \$1.50.....	3.00
Six Shifters at \$1.50.....	9.00
One Electrician.....	4.00
Two Assistants at \$2.50.....	5.00
One Dynamo Man.....	3.00
Total labor.....	\$37.00

Supplies.

Water per day.....	\$5.00
Oil and waste.....	2.80
Appurtenances and miscellaneous.....	2.80
Total Supplies.....	\$10.60

Recapitulation and Summary.

Fuel per day.....	\$27.00
Labor per day.....	37.00
Supplies per day.....	10.00
Total cost per day for operation.....	74.00
Cost per car day for operation.....	1.48
Cost per car mile for operation.....	1 2/100 cents.
Cost of maintenance per car mile.....	2 3/100 cents.
Total cost of maintenance and operation per car mile.....	3 5/100 cents.

The following are some of the conditions fulfilled by this company with its storage battery cars.

1. That each car will be delivered in first class order with appliances for keeping it well under control, and for readily operating it with such skill as would be possessed by an intelligent car driver after suitable instruction.

2. That each car will be run fifteen (15) miles an hour on a straight level and suitable track, in good order, when carrying fifty (50) passengers, or an equivalent weight not exceeding 6,000 pounds.

3. That each car with the above load will ascend grades not exceeding five per cent. and not longer than 500 feet, at the rate of at least five miles an hour.

4. That two sets of batteries per car shall be delivered, either of which when fully charged shall be capable of propelling a loaded car as above on a straight level and suitable track for a distance of sixty miles, if required, when it shall be replaced by the reserve battery, which meanwhile shall have been fully charged. Each battery can be charged while its alternate is being used. As a matter of policy, we advise retaining one-third of the charge of the battery, as a reserve for emergencies.

5. That the batteries, when treated according to printed instructions and their parts renewed as required, will remain in an efficient condition.

We have already touched upon some points of advantage in the storage battery traction over the trolley system. We will now refer to the inherent defects of the trolley system, which do not pertain to storage traction.

1. The disfigurement of streets by double lines of poles and trolley wires, with cobwebs at every curve.

2. The frequent interruption of the entire system by a break-down at the power station or in the feeder wires.

3. The great and sudden fluctuations in the load, which make such break-downs of the power plant extremely frequent, many such break-downs having already occurred. With trolley and cable lines, the extremes of no load and a full load are reached suddenly from one to a dozen times every five minutes. This is not only destructive to the machinery (steam, electric and cable), but frequently causes a break-down of the whole line, involving heavy outlays for repairs, serious loss of revenue and dissatisfaction on the part of the public.

4. Bad economy in the power station, due to the fact that maximum power must be provided in the engines and dynamos instead of average power as provided in the storage system, causing the engines with the trolley system to run with an average of about half their load and therefore uneconomically; with storage battery traction the engines and dynamos run with an even and unfluctuating load continuously, giving the best possible economy of cost and increasing the life of the plant.

Economy and inconvenience of operation as compared with requiring an expenditure of energy in all portions of the line, even though but one or a few cars may be running. For suburban roads and all night runs this feature is of special importance.

Street Car Circular No. 8.

6. Liability of generators and motors being burned out by lightning passing through the bare trolley wires through the motors to the ground.

7. Liability to motors burning out with the high voltage current.

8. The business public is inconvenienced by the derangement of the telephone service, due to induction and leakage from the trolley lines to such an extent as to make the telephone service useless and dangerous.

Last and perhaps most important at least to the general public, the trolley system requires a current of high potential conducted along bare wires, extending over the entire route of the line, always liable to contact with electric light, telegraph, telephone, district messenger, fire alarm and police alarm wires, the system thus being a constant menace to life and property throughout the city. Contact with any foreign wire may lead to a conflagration such as destroyed immense values of property in Lynn and Boston within a year, and death to horses and human beings, numerous instances of both having been frequently reported in the public prints.

Therefore we feel warranted in asking street car companies to give storage battery traction, which possesses none of these disadvantages, and involves none of these dangers, a fair trial under reasonable conditions, and under the supervision of men experienced in the various branches of engineering involved in the business, and who have had nine years experience in the manufacture and use of storage batteries.

Mr. Richardson, of Brooklyn: I understood the gentleman to say that the storage battery car could run fifteen miles an hour for four hours; and that it takes as long to charge the battery as it does for the battery to work.

Mr. Bates: You are correct.

Mr. Richardson: There lies my great doubt as to its practicability in a road that wants to run fifty cars three minutes apart.

Mr. Bates: By a suitable provision of alternate batteries that is accomplished easily. One of our cars has been in daily operation in Dubuque for sixty days, and we are now equipping the road with six cars.

Mr. Richardson: How long does it require to take out one set of batteries and substitute another?

Mr. Bates: It depends largely upon the skillfulness of the men employed; from one and a half to three minutes.

Mr. Richardson: What do you base your calculations upon as stated in your remarks; from actual figures that you have, or by approximation?



Mr. Bates: From figures which we have very carefully prepared, and which are approximately correct, based upon ten thousand miles of service with our three cars.

Mr. McCarty, of Kansas City: How many horse power per car is required?

Mr. Bates: It depends upon the number of motors we put out; ten horse power is about the amount of steam plant we require per car.

Mr. A. A. Chadbourne, of the Wenstrom company was the next speaker. He said:

Nearly every year there is brought to you something new in this line. This year we come before you with something that is a novelty. I think it is generally acknowledged that it is desirable to have a slow speed armature in a street car motor, and that the motor should be reduced in weight as much as possible, and if possible, a device provided whereby the armature could be allowed to run free at all times without relation to the car speed. We accomplish these results in a very satisfactory way. We expected to have had a car in operation here but owing to delays at our factory, have not been able to do so. We have a cast of our field magnets here. It is cast solid. The machine is 25 horse power. The fields are cast in one solid piece of mits metal. The speed of the armature is four hundred revolutions a minute, developing twenty-five horse power. The metal is cast in such a way that it has nearly the same properties of wrought iron, and has the advantage that it can be welded. The wires, instead of running over the periphery of the armature, run through it, and the external portion is turned down true, so that it presents a plain surface. The advantage of this is that it is impossible to have the wires spread or thrown apart. Another feature of the motor is the method of connecting the wires on the commutator. Sometimes there is a great deal of trouble with these connections by reason of the solder melting. We have no road in operation yet, but will have in operation at Pottsville, Pa., by the first week in November. We also expect to have a motor in operation in Baltimore very shortly. Our construction is not unlike other companies in its detail, the overhead arrangement of wires being the same. You know what the trolleys are. The generator is unlike those with which you are familiar. It is a machine that works at slow speed. We also have a patent connection between the armature and the commutator. It runs at four hundred and twenty-five revolutions per minute, developing sixty seven and a half horse power, running perfectly cool. A peculiar feature is that their construction is such that they utilize to a greater extent than any other machine, the magnetic qualities which are generated in it. Another point is the gearing. You are all familiar with the ordinary gearing. We have a gearing which we are prepared to put under any system. It is an inexpensive gearing to buy, and it is economical to operate. It is a gearing with wooden teeth and has a removable rim, which is absolutely noiseless; and we have reduced the point of wear to the cheapest part of the gear, the teeth. No matter how small the accident, if one of the teeth breaks, the gear is gone. There is no reason why our gear should ever break, and the wooden teeth will last anywhere from four to six months, in accordance with the work. In Atlantic City they ran all summer long. The manager there stated that the gears had done excellent service. We use this gear on our system, and will put it on any other. Another point is, that owing to the slow speed we do away with the intermediate counter-shaft, and consequently that does away with two bearings and two gears. We gear direct from the armature to the car axle. There is another feature worthy of your attention, and that is the method by which we allow the armature to run at full speed at all times. The armature is started up, and the gear runs freely; the rim revolves freely around the axle and is connected to it by a system of hydraulic gearing. It is by the operation of the oil in the gear that we get the difference of speed in the armature and car axle. The oil is forced up from one part to another and when the valve is open the rim (or arm) will run free. If the valve is half way open you will get a variation of speed.

Mr. Henry, of Pittsburgh: Do you propose in that machine to do away with the intermediate gearing entirely.

Mr. Chadbourne: Yes, sir.

Mr. Henry: In that way you get rid of one half the machine under the car?

Mr. Chadbourne: Yes, sir. We do away with a large factor in repairs. It is the high speed of the street car motor that makes the trouble with the gearing. If your intermediate gear only ran one hundred and twenty-five revolutions, it would be a very simple matter to keep the gears on. In a slow speed machine much of this trouble is overcome, and it is acknowledged to be a very desirable thing.

Mr. Malone Wheelless, of the Wheelless Electric Company, next addressed the meeting.

We have a system in Washington that differs in no respect from the other systems, except, that we carry our cars by an underground cable. It extends the whole length of the road, and feeds from the sections which are laid in the conduit and laid in the usual way. The sections of the conduit are carried along, and at every three hundred feet, more or less, as occasion requires, switch boxes are put in. This is about sixteen inches square, and laid between the tracks in double

tracks, or between the rail and slot rail for single track roads. The object of these switch boxes is that when the car comes along they automatically connect the current in the cable with a given section. Suppose we have a mile of road, there is a mile of cable laid by the side of the track. From that cable at every three hundred feet is laid a feeder that feeds one insulated section of conduit wire. The conduit wire is at all times dead; there is no current in it. The current at all times is in the cable, and when the car comes on to a section a device attached to the car acts in conjunction with the switch box, and the result is the connection is made from the cable to the wire in the conduit. The car instantly receives the current, and passes over that section and on to the next, when the passage of the car off the section releases the armature in the switch box, and as a consequence the section is cut out. The reason of "cutting in" is because putting a continuous conductor in a conduit has been found inexpedient, for two reasons. The first is the escape. I believe it is impossible to take a continuous conductor and transport it through five or six miles of conduit, and not have such an escape, no matter how well insulated, that the efficiency of the motor is materially and seriously impaired when you get a long distance from the generator plant. The other reason is, the liability to short circuit. The advantages we found in cutting our wire in sections was that only a certain section was charged with current, and consequently a short circuit could only occur at the point where the car was. This constitutes about what our underground system is; it is simple, and does not exceed in cost the ordinary conduit, or very little more. Our overhead system is a duplicate of the main feature of our conduit system. We feed in sections. The overhead line is dead at all times, and there is no way in which a person can receive a shock from it. I shall be glad if gentlemen present would come to Washington and see our system.

Knight Neffel, of the New York United Election Traction Co., then addressed the convention.

It is unnecessary for me to say anything regarding the value of storage battery traction, after the very apt remarks made by my friend of the Accumulator Co. I will simply give concisely our results in operating ten storage batteries cars on the Madison avenue line in New York.

The equipment of each car consists of 108 Julien cells in 12 trays, 9 cells in each, total weight 3,600 lbs. The motor in use until recently, and on the old cars now running, are of the Thomson-Houston type. We have now constructed a motor especially adapted to this class of work, and which is now being put on this line. An estimate of cost of operating has been submitted to you by another company, based on the performance of 50 cars. Our experience with ten cars in actual operation over an extended period, which by the way, is the largest storage plant in this country, and next to the largest in the world is as follows.

Generating plant 8 h. p. per car. For ten cars 15 batteries are necessary. Rate at each battery is charged one and one half hours for two hours discharge. One charge is adequate for a run of forty miles and a level track. With the old cells and the old type of motor these ten cars were operated with 10.6 per car mile with the improved batteries and new type of motor. The life of the existing plants of the battery, at the present rate of disintegration, is at least three years. The negative plates, the other half of the battery, are as durable as the motor. It is generally conceded that the reason storage batteries have not been applied more extensively is lack of confidence in the endurance of the batteries and litigation on patents.

We are prepared to demonstrate to you practically the life of the batteries, and the question of patents has been greatly cleared by the final decree, giving Charles T. Brush, of Cleveland, a fundamental award of priority.

Our batteries are manufactured under the patents of Brush, Julien, Morris, Salome, and others. We are now equipping a road in Indianapolis, Ind., on this system. Our company also furnishes over head equipments and we shall be pleased to have any member of the convention visit the plant at Madison avenue, and the other roads equipped by us.

Mr. Graham, of Baltimore: Can you tell me the number of miles per day each car runs?

Mr. Neffel: Eighty.

Mr. Graham: The maximum grade?

Mr. Neffel: The maximum grade is about five and-a-half or six per cent; there is a very severe grade for a short distance on one part of the road, between 72d and 70th street going down.

Mr. Graham: What is the length of the grade.

Mr. Neffel: About two blocks.

Mr. Graham: Do you ever run on a grade higher than five and-a-half per cent?

Mr. Neffel: Yes, sir, there is one grade which is seven and-a-half per cent. The motors will go up that, but, of course, it discharges the batteries very rapidly, when you subject them to such heavy work.

Mr. Graham: Is the car capable of ascending any usual grade, say ten per cent?

Mr. Neffel: Yes, sir; it is simply a question of discharging the batteries.

Mr. Henry: When you say ten cents per car mile, what is included?

Mr. Neffel: Everything except the conductors and drivers. Of course there is a reasonable amount for the repairs of the motors.

Mr. J. Potter, of the Short and Brush Electric company, next addressed the meeting. He said:

The Brush company, as you know, has been in the business of building dynamo machines and electric batteries for many years; being the pioneers, among the pioneers of that business, in the world. We have been building dynamos since 1876. We have recognized that the electric street railway work is the severest to which the dynamo machine has ever been subject; and in starting out in our electric work, we aimed, as no doubt all others have aimed, to build a dynamo machine that would stand the rough work, with as few failures by stoppage as possible; and in the next place to make the delays incident to such stoppage as brief as possible and the repair work simple and inexpensive as possible. We claim that with our motor we have reached a high point of perfection in these respects. The difference in our motor is mainly in the type of armature, where we use a ring instead of the usual drum type of armature. There are many advantages that we obtain by the use of this type of armature. The bobbins or sections of the armature are all independent, and in case of any burn-out or trouble, it would be confined to a single bobbin. Again, we get a very great diameter of armature, as compared with others, and are enabled to use larger pinions and save greatly in wear. As a matter of fact, since the beginning of the present year, we have never burnt out a field magnet or armature coil in actual service. This will be confirmed by any road operating our system. The favor it has met with, and the large number of orders we are taking speak loudest in praise of the system. Another feature is, the insulation of the motor entirely from the frame-work of the car and from the ground—we think this is a great advantage. We believe that a great deal of the expense and trouble is due to the grounding of the motor, the bursting through and burning out of armatures, fields and commutators. This insulation is carried to the gears. We make them with an insulated web to deaden sound, and use steel pinions and steel gears, steel axle gears, and overcome the noise at the same time.

Mr. N. J. Carruthers-Wain, President of the Tramways Institute, of Great Britain and Ireland, was next called upon.

I hope it will not be considered immodest in me to say that I am at present connected with seven different tramway companies in the United Kingdom. I have under my control horse, steam cable and electric lines; and I have got some figures as to the comparative results of the first three systems, which may be of some interest to you. On the Birmingham Central we run forty-five miles of road, steam, cable and horse. On the steam road we earn 30 cents a mile. It costs to earn that 20 cents a mile, every possible charge included. The horse department earns 20 cents a mile, and it costs 17 cents per mile. The cable earns 26 cents a mile, and it costs 12 cents a mile. Of course, in some other towns the earnings are not quite so great. The success of tramways, like other things, depends entirely on the towns in which they are situated. Of course, the cost of different articles will vary considerably. For instance, coal in one place in America costs \$1.50 a ton, and in another \$5.50; so that under these circumstances there can be no just comparison between the cost in different towns. In a tramway in London, of which I am chairman, we earn 21 cents per mile, which it costs 17 cents to earn. That is with the horse system. On another one in London we earn 18 cents a mile, and it costs 14 cents. On steam tramways in the provinces we earn 30 cents a mile, and spend 18 cents. These are the latest figures I have; but I would say, in passing, as regards the cable in Birmingham, which earns a rather low receipt of 26 cents a mile, that it took the place of an old horse tramway, which, when I took the management of the road earned 26 cents a mile, but cost 30 cents to work. Now we are working it by cable with the same amount of receipts, and it only costs us 12 cents to work. Cables have made very little progress in England, the enormous initial cost being the stumbling block, in consequence of the requirements of the local authorities. We reckon that our three miles in Birmingham cost us \$300,000 a mile, including everything, with the power house.

This is our system of working, and I am glad to tell you that in three months there has not been any hitch or break down of any kind, except owing to inattention of those sending out cars without sufficient charge in them. We are not so favorably situated as you are here. We are restricted and hampered with all manner of rules and requirements. We have got to come to a dead stop at every street crossing, reduce our speed to two miles, in some places to four, and must not exceed the fixed limit of eight miles an hour. We are very much handicapped as you can see. Altogether, it makes it quite difficult to work our system.

Mr. Richardson—Do you mean that at every street, before you cross it, you must come to a dead stop?

Mr. Wain—At every street which we cross, at right-angles, we must come to a dead stop. We are, therefore, only able to make a round trip of six miles in thirty five minutes.

Mr. Henry—What weight of rail do you use?

Mr. Wain—By requirement of the local authorities we were required to bury a certain amount of precious



metal, and were compelled to put down a rail weighing 100 pounds to the yard. We also suffer on the other side from the fatal habit of the Englishman of walking wherever he can; we suffer from the fact that he insists, when he does ride, of riding at the average fare of three cents, whereas you get five. I need hardly point out that therein lies the difference between the very meagre dividends which we distribute in England, compared with the successful results of operation in America.

I came to this country with the hope of learning as much as I could about electric traction in America. What I want to know, and most people, is the item of depreciation and repairs; in other words, repairs and renewals, and the amount to be set aside as an annual sinking fund for the question of depreciation, which must inevitably ensue. It has struck me, not only in this assembly, but in many others, that figures, after all, are rather delusive. Electricity came under my observation in this way. I was not satisfied, no man was satisfied with the system of tramway traction in Europe up to within the last three or four years. We had leased a line from the Birmingham authorities, with the proviso that it should be operated by cable; but there was not enough business to make that system profitable. Electricity appeared to be the only visible motive power, and in November, 1888, there was tried upon the Birmingham Central Tramways a self contained electric motor, which was designed upon the Julien system by Mr. Thomas Parker, of the then Messrs. Elwell, Parker, limited and myself.

The directors of the Birmingham Central Tramways Company permitted the experiments to be conducted upon their lines, upon condition that the electric motor to be used should be in the form of an engine, insisting that before they would consider the question of electricity at all in connection with their lines, they must be convinced by actual demonstration that the power was as great, if not in excess of their most powerful steam engines then in use; and when I point out that they are some twelve tons in weight, having cylinders nine inches in diameter, and carrying a pressure of one hundred and seventy-five pounds to the square inch, you will agree it was no small task to attempt. However, upon actual trial, the electric motor, although weighing only nine tons, when coupled to one of the steam engines, the electric engine hauled the steam engine in spite of the fact that steam was full on and pulling against the electric motor. We afterwards started and hauled with the electric car a load of some thirty tons up a grade of 1 in 32. We have also run with one charge of the accumulators seventy miles, hauling a car which together with the load contained therein weighed over six tons, and this on a very heavy grade of tramway, travelling up a grade of 1 in 19 over five hundred yards in length during the day ten times. This electric car has been so successfully run over their heaviest steam route, and given such satisfaction to the directors, that they gave an order for twelve electric cars, which have just completed what is undoubtedly the finest installation of its kind in the world.

The car is made to run upon a three foot six inch gauge, and is constructed to carry fifty passengers, twenty-four inside and twenty-six out. It measures over all in length twenty-six feet, and in breadth six feet three inches, and from floor to roof three feet six inches. The sole or foundation of the car body is made of channel iron, strutted so as to give it great strength and rigidity. The car body is carried upon two bogeys of the ordinary kind, and the motor is geared to the axles of one bogey by a train of helical gearing. The accumulators are placed in trays, each tray containing eight cells, and these are carried under the seats of the car, the outer panels of which slide up behind the seats so as to admit of their being readily placed in position. The whole forms four batteries. The switches are of the Julien type, and the car can be driven from either end. They are so constructed that the cells can be equalized and the batteries used either in parallel or series. The car, motor and batteries weigh nine tons, as against the steam engine and car sixteen and a half tons, a large saving in dead load to be hauled. The work of charging the accumulators is reduced to a minimum by having a specially arranged balanced lift or elevator. These work in pairs one balancing the other. Each shelf is fitted with automatic connections, and is in every respect an exact duplicate of the car, so that when the accumulator trays are drawn thereon automatic connection is made, and the cells are charged whilst in position upon the ram without again being moved.

Mr Richardson—How many cars are you running?

Mr. Wain—We have twelve altogether; but are only running five. I may say as a point of interest that during the time that line was under construction, we worked it first by a system of horse tramways, and the average takings were about seven hundred and fifty dollars a week. During the time the electric road was in process of construction the receipts on the horse line were reduced to six hundred dollars a week. Immediately the electric cars were put on, the takings jumped to twelve hundred and fifty dollars a week. This was not due to any additional service, because it is precisely the same; not to any increase in population, because it has not grown so rapidly, but simply to the fact that we have been able to put on in place of the wearisome horse-car, a comfortable car moving by electric power.

Mr. Henry—How often have you renewed the plates?

Mr. Wain—We have not renewed them at all. We expect to get a life out of our plates of six months. The question of profit on the workings of the storage battery is not a matter of speculation, but is a matter of dead certainty. Inasmuch as there are several gentlemen here connected with overhead systems, I should like to say I believe there is room for all, certainly in America, if not in England.

Mr. Henry—Do you reconstruct the horse track for the electric road?

Mr. Wain—It was reconstructed, but not solely for that reason; the road was very much dilapidated.

Mr. Henry—What percentage of loss in efficiency in the motor is there?

Mr. Wain—I am not going to give you that, because three months' work is not sufficient time in which to give a general test. I understand as nearly as possible we get fifty per cent. on the wheels.

Mr. E. E. Higgins, of the Edison-Sprague Company, next took the floor.

The Edison Company, with its accustomed modesty, desires to say that it has the best electric system in the world. The reason is two-fold. In the first place, as you are no doubt aware, it is acknowledged that the Edison motor will consume less coal. This is an important point, and has bearings in many directions. If we can operate a hundred cars with seven hundred and fifty horse-power as an average output, it means that we can have less dynamos, less engines less boilers and less apparatus in general than can be done with a system which requires one thousand or twelve hundred horse-power to operate the same number of cars. The cost of investment is less, and of course the interest is less. That is one advantage, and in addition the coal bill is much less. Another division would be the depreciation. We believe that the depreciation per passenger carried with our system can be made out less than with any other. We do not claim that it has been less in the past although not greater. We have the best roads in the country; perhaps we have some of the poorest. It is a question of management, and lies directly with you, gentlemen as to the success of electric traction. In most cases the motors do not receive the attention that would be given to an ordinary steam engine; and if you run them successively for a hundred and fifty miles a day, and do not lay them up and treat them with care, you cannot expect that your armatures will not burn out and other troubles ensue.

In the new apparatus that we are bringing out, we have made some very notable advances. In the first place our armatures are wound upon an entirely new plan—one which we think is a distinct advance. In the old style what is known as the Siemen's winding is employed; the wires are wound on the core and carried around at the end and form a conical shaped bundle, which gives a chance for play and abrasion; and this means short circuits and burn outs. With the new armatures we have a new standard coil, some sixty of which go on to the core. They are so formed that the rear of the armature, and front alike, give no chance for motion. They are brought firmly in place, and you have a diameter of armature which is always the same, because the coils are standard. With this system burn outs will be extremely rare. We do not claim that there will not be any, but we believe in the regular daily workings of the car, with proper management nothing ordinary will burn out the machine, except dead overloading. When it is burned out it can be replaced by any mechanic. The switches are on a little different plan. We have avoided the difficulty which has sometimes occurred of starting the car too suddenly, but which with careful management could always be prevented. We make it impossible to start suddenly by putting in a slow starting device, which starts the car gradually, and effects a saving of power. It is not a rheostat. We are the only company that uses commutated field coils. We believe in them; we do not believe in the rheostat. You all know about our dynamos. The reason of their success is that they are a development and not an invention. Its efficiency is over ninety per cent. in the ordinary sizes, such as employed on street railroads; in some cases it is higher. One reason of their success is that its moving parts and center of gravity is near the floor. The line construction of the company is acknowledged to be standard in respect to simplicity, neatness and cost. We use the feeder system. That is a system of wiring in which the electricity is delivered at regular intervals of a few hundred feet into a trolley wire. This results in the fact that the electricity is delivered to a large mesh-work of conductors in such a way that at every point in these conductors the pressure will be uniform.

Mr. E. H. Johnson, of the Interior Conduit Company:

I do not propose to occupy your time, but only desire to call your attention to the fact that the gradual development of the overhead electric system has become such, that in many of the larger cities it is now becoming imperative that the conductor should be placed under ground. In a city where fifty to one hundred cars are operated, there is at least ninety five per cent. of the wire on poles overhead which may with advantage to

the company be placed under ground. It is not necessary to have them overhead. The trolley wire being the only thing that is necessary to have overhead, it follows that all the feeder wires, special mains, etc., may be placed under ground. The question is, can the wires be placed under-ground with less investment, and can the insulation of the wires be maintained under-ground with less charge for repairs, and if so, how? Our company is prepared to lay down the wires under-ground and guarantee their efficiency for a number of years. Until it is rendered commercially successful, I propose to put the feeder wires under ground, leaving the trolley wire to remain over-head. The tubes are paper, treated with special asphaltic compound to render them insulated, and placed in a trench, and then filled with the insulating compound.

Mr. George W. Mansfield, representing the Thomson-Houston Co.:

As all the other companies have been represented, I suppose the Thomson-Houston Co. ought to be also. I do not know that I can say anything in particular about our system, since it is the most generally used, and must be the most generally known. We first started in the business with the feeling that the thing we had to do, above everything else, was to make as big a difference between the net receipts and the gross receipts of the company that purchased our apparatus as possible. We recognized the exigencies of the moment, and knew that we had to put our apparatus in the hands of men who were untechnical and unskilled, and who knew nothing whatever about mechanics and electricity. We felt, therefore, that we had to build additionally strong to meet that necessity. We have put out in the neighborhood of 3,500 motors. I think they are nearly all running. The first motors we put out are in operation to-day, and gears, armatures, spools and the various parts constituting the motors that are built to-day can be used with the motors first put out. We feel that we have planned on the correct principle. I want to make an appeal to you, gentlemen, much in the same vein as my predecessor, Mr. Higgins. That is regarding the management of the electric apparatus. If there is any one thing that has injured the business in the eyes of the public, who are not interested in electric roads, it is in many instances lack of management on the part of the railway companies that are operating the electrical apparatus. Many roads are a disgrace to the directors and every one connected with the company, because the motors are kept in dirty condition. They are not handled by men who have the requisite skill and intelligence. Any one knows if a steam engine is not taken care of it goes to pieces; and the same is quite as true of electric motors. The railroads should employ men of skill and brains and intelligence to look after these mechanical and these electrical details; and the more information, the more knowledge they have, the better they will perform their work.

In regard to new apparatus, we are constantly improving all our details. We are making the motor stronger where every experience has dictated it to be necessary, and we are making it lighter wherever it is necessary. We are improving each detail of the entire apparatus and increasing efficiencies; so that in a very short time we will have the most complete system. Our switches at each end of the car are under the hood of the car, so that in case of any accident or any trouble, the conductor at the rear end can cut the circuit, either with his switch or by pulling a trolley wire down; and the driver also has that facility. We have a fuse-box on our car, and it is a very simple matter to replace a fuse if the driver has been careless or ignorant or unskilled, and turns his current too quickly on. That operates as a check against the man as well, as a record can be kept of the number of fuses used. We have a lightning arrester, which we claim is the only one of practical value. As to our motors, we build 10, 15 and 20-horse power of one type, and the same power of another type, so that we can use our motors either singly or double upon trucks of any gauge from 3 feet 3 inches up to 6 feet. If the railroad men would get down to a uniform gauge it would help us out very much. As to station apparatus, our dynamo has an efficiency of over ninety per cent. It will pull through more hard raps and do more service in a given space of time than any other. In our new work we are pushing ahead and building dynamos up to twenty-four and twenty five hundred horse power, and directly coupled to engines also. We are building heavy motors for excessive work and for tow work; and we are going into all sorts of devices and experiments in regard to constant speed motors and slow speed motors. We want to be sure first that any new thing is far superior to what we have before we put them before the public.

Mr. Richardson: What is your expectation as to having something better in the near future?

Mr. Mansfield: I do not know exactly how to answer your question; but I do not think the electrical appliances will improve more than fifteen or twenty per cent. for many years to come.

Mr. Richardson: You can not promise anything in the next six months?

Mr. Mansfield: No, sir.

The Secretary announced that he had received a paper from Mr. E. L. Woolley, Superintendent of the Lincoln Street Railway, Nebraska, on the subject of Spiral or Transition Curves for Street Railways Operated by Mechanical Motors.

The paper was read, as follows:



SPIRAL OR TRANSITION CURVES FOR STREET RAILWAYS OPERATED BY MECHANICAL MOTORS.

In ordinary railroad practice spiral curves are, in theory no new thing, although even in this field they have never received the attention which the importance of the subject demands. I feel safe in making the assertion that there is no road in the country where they have been introduced that would not think of building a railway, involving what might be considered even moderately sharp curvature, without the use of spirals.

In the construction of street railways, we are obliged to use curves very much sharper than the engineer of an ordinary railroad is ever called upon to contend with. At the same time our rolling stock is comparatively little better adapted for traversing sharp curves. So long as street cars were operated by animal power only, the speed was necessarily slow, and the need of transition curves but little felt. With the introduction of mechanical motors the weight of our rolling stock is immensely increased and at the same time the maximum speed is probably three times greater than with the old system of horse power. The practice of running cars in trains immensely increases the difficulty, so that now the blow given by the leading outer wheel as it first strikes the outer rail at the entrance of the curve is probably ten times greater than with the horse car. So long as circular curves only are used, there is but one way of reducing the shock to passengers and cars and the constant danger of derailment at these points, and that is, to reduce the speed of the train. In the crowded business streets of a great city, this reduction of speed is perhaps no disadvantage, there are, however, many places in the suburbs and outlying districts, where a reduction of speed would not be necessary but for the presence of the curve. It is in such places as these that the spiral will have the greatest advantage, although even at slow speed the passage of a sharp curve properly "spiralized" will be found infinitely smoother and better in every way.

In the practical application of the spiral to street car curves, I have not as yet been able to give it as thorough a test as I could wish, however, I have done something in this direction. During last March, while in the employ of the Denver & Berkley Park Rapid Transit company, at Denver, Colo., I laid out a curve of one hundred and forty feet radius, using spirals 100 feet long. The line was built to a three feet, six inch gauge, and operated with Baldwin steam motors weighing about 32,000 lbs, with trains of from one to three eight wheeled cars, each thirty feet long. This was my first experiment with a sharp curve, spiralized. The first train to pass this curve was sent round at a speed of ten miles per hour. No jar, whatever, was felt upon entering the curve. Afterwards it was tried at higher speed, until finally, as a test, an engine was sent around the curve at twenty-five miles per hour, and still there was no sign of shock or jar when entering or leaving the curve. This line had previously been in operation something over one year, and a great many passengers were in the habit of locating the point where they wished to leave the train when coming home at night, by passing this curve. After the spiral curve was put in, dozens were carried by their stopping place on account of the train passing the curve so smoothly that sitting in their seats, they did not notice it afterwards. I made another test with a curve of seventy feet radius, with results proportionately good. As yet, I have had no opportunity of testing the advantages of the spiral on curves of forty and fifty feet radius but I firmly believe that by using spiral transition curves we may double the speed in passing any given curve without increasing the danger of derailment and with much less strain or shock to the cars and motors.

In regard to the methods of laying out these curves, I, myself, use a method in some respects different from anyone else, so far as I know, but the methods of Wellington, Searle, or Henck may be used; either will give satisfactory results. Perhaps the best method as yet published may be found in a pamphlet, The Railroad Spiral, by Prof. D. M. Greene, of the Rensselaer Polytechnic Ins., of Troy, N. Y. It will matter but little what method is used. But care should be taken to lay out the spiral accurately, and in laying track, rails should be curved very carefully. If points are set on spiral from five to ten feet apart, the trackmen can stretch a line of one rail length along spiral and take ordinates for curving rails directly from the stakes.

On motion of Mr. Eppley, of Orange, N. J., a resolution of thanks was passed to the Trunk Line Association, the New England Central and Southern Passenger Associations for their courtesy to the Association in making the concession of the reduced rate of a fare and a third to all in attendance at the meeting.

The Nominating Committee reported the following officers for the ensuing year:

- Henry M. Watson, of Buffalo, N. Y., President.
- W. A. Smith, of Omaha, Neb., 1st Vice-President.
- Charles Odell, of Newburyport, Mass., 2d Vice-President.
- A. D. Rogers, of Columbus, Ohio, 3d Vice-President.
- Wm. J. Richardson, of Brooklyn, N. Y., Secretary and Treasurer
- Executive Committee:—Thomas Lowry, Minneapolis, Minn.; D. F. Henry, Pittsburgh, Pa.; Albert E. Thornton, Atlanta, Ga.; H. M. Littell,

Cincinnati, O.; Thomas C. Keefer, Ottawa, Canada.

The committee had received invitations from two cities to hold the next convention, Pittsburgh and Kansas City, and recommended the former.

The report was received and a ballot duly cast for the nominations as presented; whereupon a committee was appointed to escort the newly-elected president to the chair.

President Lowry, in retiring from the chair, said:

I desire to return to the convention and every member of the Association my sincere and heartfelt thanks for the courtesy with which you have treated me during the short period that I have presided over your deliberations. The period has been so short that it makes me feel something like the little darkey who said he joined the Methodist church for six months and they liked him so well that they let him off in three. I have now the pleasure of introducing to you the newly elected president, Mr. Henry W. Watson, of Buffalo. [Applause.]

Mr Watson, who was received with cheers, then took the chair and said:

Mr. President and gentlemen of the Association: When I invited you in Minneapolis to attend the ninth annual meeting in this city, it was with the hope and expectation that the Buffalo convention would prove to be the most important and progressive in the history of the Association. I am sorry that after doing so well up to this time you should have determined to take a step back. The president of the Association this year should be a pioneer in the use of electricity. I am frank to say that I do not aspire to this high office, to which in your kindness you have elected me. On the other hand I did everything I could to escape it, but there seems to be no way out of it, and now I thank you most heartily for the compliment you have bestowed upon me, and with your cordial co operation I will do the best in my power to promote the interests of the Association. [Applause.]

A vote of thanks was passed to the retiring president, and the Association adjourned to meet at Pittsburgh, Pa., the third Wednesday in October, 1891.

THE BANQUET.

About eight o'clock the delegates, ladies and friends entered the dining room and were soon arranged at the beautifully decorated tables. The table of honor was along the south side of the large dining hall and three ells from this extended along the large room. In the small room the arrangement was about the same with but two ells.

Large flat bouquets of roses and smilax formed the center pieces, while in front of the president's chair was a beautiful car of immortelles in a large bed of roses. A large cable of smilax was gracefully wound along the tables from bouquet to bouquet. Stands of fruit and growing ferns completed the decorations.

The menu was a handsome four-leafed card, with panel cover ornamented on front by an electric car and trolley wire and lettered in red with the name and date of the meeting. On the back cover was a handsomely printed street car ticket, front and reverse side. The first page gave the names of the officers and executive committee, the second, the menu, the third, the toasts and names of speakers, and the fourth, musical programme.

The latter was beautifully rendered by an orchestra stationed in the lobby.

MENU.

- HUITRES.
- Haut Sauternes.
- Tortue Verte, aux Quehelles.
- Victoria.
- Consomme Cavour.
- Timbale de Chapon, a l'Imperatrice.
- Varies.
- Oregon Saumon Trianon.
- Combres. Pommes Surprise. Liebfraumilch.
- Filet de Boeuf, Pique, Miraban.
- Haricots Verts. Chateau Beycheville.
- Burton & Guesliet.
- Ris-de-Vean, Glace, Puree Marons.
- G. H. Mumm's Extra Dry.
- Artichauts Francaise, Sauce Hollandaise.
- Sorbet, a L'andalous.
- Dry Monopole.
- Perdeaux, an Cresson.
- Ruinart Vin Brut.
- Galantine de Vola lle aux Truffees.
- Celery, en Mayonnaise.
- Chateaubriand.
- Gelee Macecloine.
- Meringue Chantilly.
- Petits Fours, Assortis.
- Fruits. Fromage. Café. Liqueurs.

TOASTS.

- ADDRESS OF WELCOME, - Mayor Charles F. Bishop.
- THE CITY OF BUFFALO, - - - Mr. E. C. Sprague.
- Considered a failure for hunting the bucephalous bison, but a large success as a railroad gridiron.
- OUR NATIVE LAND, - - - Mr. Charles B. Holmes.
- "Breathes there the man with soul so dead,  
Who never to himself hath said,  
This is my own, my native land." [Wain.
- THE TRAMWAYS INSTITUTE, - Mr. W. J. Carruthers
- "One touch of nature makes the whole world kin."
- STREET CAR ETIQUETTE, - - Mr. Henry W. Box.
- "He stood a spell on one foot fust,  
Then stood a spell on t'other,  
An' on which one he felt the wust  
He couldn't ha' told ye nuther."
- ELECTRICITY, - - - - - Mr. C. A. Richards.
- "Our hearts, our hopes are all with thee,  
Our hearts, our hopes, our prayers, our tears,  
Our faith triumphant o'er our fears,  
Are all with thee, are all with thee!"
- THE STREET-RAILWAY PRESS, - Mr. J. H. McGraw.
- "The observed of all observers."
- THE EMPIRE STATE, - - - - Mr. John Laughlin.
- The crown jewel in the national diadem. First in wealth and population, may she also be first in the arts and virtues which constitute the true grandeur of nations.
- THE PRESS, - - - - - Mr. Edwin Fleming.
- "Nothing extenuate, nor set down aught in malice."

After the company had shown evident appreciation of the good things set before them, by a liberal consumption thereof, Vice-president Wyman called the assemblage to order, and announced, with regret, that the genial and witty ex-president of the Association, Mr. Thomas Lowry, who was to have presided at the Banquet had been obliged to depart for home, and that, therefore, the duties of the office devolved upon him. Mr. Lowry had, however, left his blessing for all the company, and had expressed the hope that they would have a good time. Of this, Mr. Wyman said, he had ample evidence.

Mr. Wyman also announced that owing to unavoidable business engagements, Mr. Charles B. Holmes, of Chicago, who was so well esteemed and beloved, would be unable to respond to the toast "Our Native Land," as set down in the list of toasts.

The Mayor of the city of Buffalo, Mr. Charles F. Bishop, was then introduced.

ADDRESS OF WELCOME BY THE MAYOR.

It may be thought that there is an element of irony in welcoming the Street Railway representatives to this city. Judging from the common speech of people here, the estimable gentlemen who are at the head of the street railway business are not so modest as to require a welcome to any place when good things are to be seen or had, and it may be fair to infer that street railway men coming from other localities have, too, some little assurance. I would not have you think that this city is at war with her street railway benefactors. To be sure they usually take what they want, but they do it so adroitly, so graciously, and with such abundant good nature that we rather enjoy seeing our good things thus taken. And so, notwithstanding the encroachment of the able, affable and insinuating street railway men, the city of Buffalo still retains authority enough over the things which were once her own to extend a hearty welcome to any one. And I take especial pleasure, as the chief executive of this city, in welcoming all the gentlemen here assembled. If it is difficult for all the city to dwell in peace with these street railway corporations and retain many of her rights and franchises, it is also true that life would be hardly endurable without the street railway systems. Our people fully appreciate how inestimably these systems have in the past added and must in the future add to our wealth and comfort and prosperity. Perhaps no private enterprise is of more general public importance. The whole people watch with absorbing interest every extension or improvement in the street car service. No man can entirely dispense with the street car and to many it is the avenue to a home and independence. At the present time in particular the city of Buffalo looks to the street car service for great benefits.

It knows how much that service can do for a growing city. The enterprise and public spirit of those who have had the management of the service in the past have built up a great system and we expect to receive in the future every good thing which science and wealth can produce.

Gentlemen, you are welcome here. If you come from Canada we are glad to have you here. The city of Buffalo has much reason to wish that the most cordial relations should exist between it and that great country. Our citizens are bound to you by business and social ties, and I hope that those ties may multiply and grow stronger as time goes on. If you come from any part of the United States you are also welcome, you have the liberty and freedom of the city, gentlemen, and I hope you will be pleased that you came, and when your labors are here completed, and you return to your homes, you take with you only pleasant memories, and the desire to come again. If



you cannot during your stay in our city get about on the street cars fast enough and far enough to suit your inclinations you are free and at perfect liberty to walk. I hope you will regard yourselves as the guests of all our people, holding a pass to any place or thing which may contribute to your enjoyment. Again gentlemen, on behalf of the citizens of Buffalo, I extend to you a hearty and fraternal welcome and the freedom of the city without reserve.

SPEECH BY MR. E. C. SPRAGUE.

Mr. President, Mr. Mayor, Ladies and Gentlemen—I desire in the first place, speaking for the City of Buffalo to-night, to congratulate the American Street Railway Association upon the news which has been communicated to me to-night, that the Association has selected as its President for the coming year an honored and beloved citizen of Buffalo. Ladies and Gentlemen, the City of Buffalo has taken pride in the fact that it has presented to the country two Presidents of the United States; President Fillmore and President Cleveland: I think, however, that it has never aspired to, and never thought it should, present to the country a President of the American Street Railway Association. That is an honor, indeed. We feel as if we were crowned to night with glory and honor. We feel as if we had honor enough. Why, ladies and gentlemen, we are satiated with honor; Well, my friends, I have something now of a melancholy character. It gives me great regret in speaking of the interests of Buffalo, to say that her agriculture is in a very low state. I can remember the time when the geographical center of Buffalo was occupied by the remains of the aboriginal forest, and when we did a considerable business in timber. And it is only within ten years that a large proportion of the territory of Buffalo was devoted to the raising of stock, to oats, wheat, corn, peas, barley, cabbage, turnips and the other vegetable productions of the soil; and now, where formerly you would behold waving harvests and grazing cattle, we find the soil all occupied with buildings, dwelling houses, railroad depots, warehouses and manufacturing establishments. I do not know how it is with other cities; what the state of that interest is; but if in Chicago, and Minneapolis and Cleveland and Pittsburgh, agriculture continues to thrive and fields are not filled up with these obnoxious edifices as they are here, all I can say is that the people of Buffalo are so constituted that they will not envy these cities their agricultural prosperity.

I have no time to-night to talk about those subjects which are supposed to properly come under the consideration of a gentleman who is honored with the position which I occupy here this evening. I do not propose to say anything about health and population, about manufactories and commerce, about streets, avenues and pavements, gas, electricity, telephones, telegraphs, scientific, literary and benevolent institutions, asylums for foundlings and orphans, and old men and women of every description, old, young, married and single; nor do I propose to talk about the hundred miles of railroad tracks, and the scores of car crossings, which form the subject of so much of the pride and the prosperity, the misery and the oburgations of the good citizens of Buffalo. All these things, ladies and gentlemen are mainly visible to the naked eye; and all of them have become so eloquent of late, that, as Mr. Webster said of the history of Massachusetts, the world knows them all by heart.

Now, ladies and gentlemen, there are things about Buffalo that I may talk about. As Mr. Webster said in 1851, when he made a speech in the park in the City of Buffalo (which many of us well remember), he knew in whose presence he stood; and I may say I know in whose presence I stand to-night. I have read quite a number of the addresses which have been delivered before the members of this Association; and I know, therefore, that I stand in the presence of bards and of poets. I know, also, that I stand in the presence of ladies here to-night; and we all know that woman is simply poetry incarnate. I therefore beg leave to say a few words, and I know how very brief I should be on this occasion. Now, I might say that Buffalo combines all the advantages of all the cities that have ever been known in the history of America; and that is faint praise. In the first place, speaking poetically, Buffalo possesses a baseball club that has never known defeat; that is, hardly ever. Then I want to say a word about our climate. Now, before this city was incorporated, there was a time when something might have been said by a critical spirit hostile to the climate of Buffalo, but it has always been the custom of the citizens of Buffalo to elect as members in its Common Council, not only gentlemen distinguished for their civic virtues and large acquirements, but particularly distinguished for their profundity in scientific pursuits. These gentlemen have devoted themselves ever since 1832 to the amelioration of the weather of Buffalo and they have met with wonderful success. The result has been that in Buffalo we bask in eternal sunshine, except when, at due seasons, the rainbow tinted clouds distil soft showers upon us, at intervals appointed by the Park Commission. In the winter delicate carpets of snow are sometimes spread over our streets like the floor cloths of a ball-room, for the delectation of our citizens in the festive season. Our climate here is as calm as an unruffled sea, always, that is almost always, except when, at due seasons, zephyrs of the lake here are let on under the direction of the Board of Health. Then let me refer a moment to our architecture. It must be confessed that it is assuredly a great delight to the traveller coming from the east. In the first place, take notice of the magnificent edifices which constitute the Lake Erie and Western, and the New York Central Railroad depots. They are probably the most stately edifices of the kind in the known world, especi-

ally when you consider their elegant adornments, and the delightful arrangements you have for the accommodation of ladies and other persons who spend their time travelling through the country. Then, as you come up Exchange street, what can be more delightful to witness than the alternate "cut rate" ticket offices, which attest the interest which our people take in travelling, and alternating with those delightful retreats which are vulgarly called saloons, where beverages are dispensed that never, or scarcely ever, inebriate, and where our citizens love to congregate for the purpose of talking over scientific problems and our duties as citizens, and the great fundamental questions that affect the welfare of the human race. Then when you come up on to Main street, what a spectacle presents itself. It is indeed a sight. Why, ladies and gentlemen, you do not see when you come up on Main street, a solid row of monotonous eight or ten story blocks that weary the eye, and are copies—base copies—of the architecture of Europe; but you see an aboriginal architecture, entirely indigenous and worthy the race, and which shows a new departure of independence of the restraints of architecture in monarchical countries. I want to call your attention also to the Soldiers' Monument; a monument so stupendous and so strong, that when a slight defect in its base was found—which nobody but a Buffalonian would have discovered, it took two years to take it down, and it seems as if it would take five years to put it up again.

I call your attention, also, to our bridges. Talk about the bridges of the Seine, the bridges at Rome, and the bridges at London. I wish to have you all go up and see the Ohio street bridge. Go up there and see what can be done in the way of monumental bridge architecture. Go and visit the gentle flowing style of the Michigan street bridge, with its beautiful arches and ornaments. They boast in Venice of the Bridge of Sighs, and I have been there; but it is not as bridge a bridge as the bridge across the Evans ship canal in the city of Buffalo.

If you will pardon me a moment or two more, I want to say something of the people that inhabit this charming and beautiful city. Ladies and Gentlemen, the people of this city are so constituted that they can not bear the slightest soil or dust in the streets; expectation, for instance, is strictly forbidden. Our policemen are obliged to pass examinations before the civil service reform committee in the ten commandments of the Sermon on the Mount; and every citizen—if such a one could possibly be found in the city—who is discovered transgressing either of the ten commandments or transgressing any of the parables of the Sermon on the Mount he is immediately driven from the city, and is never allowed to return again. Let me also call your attention to a very remarkable characteristic of the women of Buffalo, and that is, that every woman in it is adequate to her furniture, and that every man in it is superior to his house. We have no luxury, gentlemen, among the ladies; no luxury and ostentation in the City of Buffalo. The earnings of the rich are distributed freely among the poor. We all walk together as brethren. Our employers' chief concern is the happiness of their employees, and the employees here have no interest but the prosperity of their employers. Gentlemen are called gentlemen, and ladies are called ladies, by reason of their characteristics and their manners, and not by reason of their surroundings; so we have as many ladies at the washtub as in the parlor and as many gentlemen at the forge as in the study. It is impossible in Buffalo to ever hear an ill-natured criticism of one woman upon another woman's bonnet. In short, ladies and gentlemen, Buffalo not only professes, but practices the Christian religion. Our churches are all perfectly tolerant of each other; our clergymen all agree to allow their fellow brethren their own opinion, and are all united in one solid phalanx of good works to get rid of the devil and all his works in the City of Buffalo.

I think, however, that this is a proper occasion to say a few words in respect to the history of the street railroad system in this city, especially as it gives me an opportunity to pay a tribute of respect to the memory of a gentleman whose name should be always honored in the City of Buffalo, and by all men interested in street railroad enterprises. I mean Mr. Stephen Van Rensselaer Watson.

Much dissatisfaction has been expressed from time to time with the slow progress in the construction of street railroads in this city, and with the inadequacy of their equipment; just as if in the times past, all the other enterprises of Buffalo had progressed at lightning train speed. To those who know the facts, so far from there being any ground for these complaints, one of the marvels of the history of Buffalo is the amount of track laid and the completeness of the equipment of our street railroads.

In the years 1859 and 1860, two street railroad companies were organized, one called the Niagara Street Railroad Co., operating its road on Niagara Street from Main to Amherst streets, and the other called the Buffalo Street Railroad Co., running its first road from the foot of Main Street to Scajaquada Creek, or what was in those days also known as Three-Mile Creek. These organizations were extraordinary enterprises for those times. The city was still suffering from the panic of 1857. It was utterly uncertain whether the enterprises would pay expenses. Money was scarce and the rate of interest high. One of the most serious obstacles to success was the sparseness of the population in comparison with the territorial extent of the city, and the size of the lots which our people have been accustomed to occupy for dwelling purposes. Another difficulty has been the opposition made to the railroad tracks through the streets which it was necessary to occupy in order to reach their terminal points. One thing, however, it

gives me pleasure to state, and that is that the Common Council of this city has always steadily supported every effort of the street railroad companies to extend their lines and increase their facilities, as (so far as I am informed) it has always supported every enterprise which has had for its object the prosperity and adornment of our city. Many of these enterprises have been opposed by conservative gentlemen as being ahead of the times, or involving too large expense; but the members of our Common Council have always been progressive in their views, and I think that in every instance the result has justified their action. While there have been complaints in regard to the extravagance of some of the city's improvements, I do not think it is exaggeration to say that there is no city in this country which has more to show for the money spent than Buffalo.

Mr. Watson was one of the original stockholders and directors and the first president of the Buffalo Street R. R. Co., and continued to be its president to the time of his death, with the exception of one or two years in the early history of that company. I think that the Buffalo Street R. R. Co., finished its road to Scajaquada Creek in 1860, and in the same year laid down tracks on Batavia, Genesee and Ohio streets, under grants from the Common Council. I do not know how much money was originally invested in either of these enterprises, nor am I familiar with the financial operations of the Niagara Street R. R. Co.; but so far as the Buffalo Street R. R. Co., is concerned, I know that from 1860 to 1867, it was constantly laying more tracks than it had means to pay for, and borrowing all the money it could on bonds and promissory notes. Substantially the entire concerns of the company were in the hands of Mr. Watson, and so continued until the year of his death. He also gave his personal oversight to every detail of the purchase, construction and management of the company's property. From the start and always he had faith in the growth of the city, and in the ultimate success of its street railroads. He was a man of large ideas, looking far into the future; of a sanguine temperament, public-spirited, great hearted, and the most indefatigable and industrious man whom I ever met. From before sunrise to after sunset he was accustomed to give his individual time and labor to the service of the company. He was always pushing the Buffalo Street Railroad and its equipments to the utmost, and for that purpose was an enormous borrower, and was constantly pledging his individual credit to sustain the credit of the company. No dividends were declared. All the net earnings went into the roads. But in those years Buffalo was a comparatively slow city. Its recovery from the panic of 1857 was very gradual. Almost everybody but Mr. Watson became discouraged. He never did. The Niagara Street R. R. Co., was in a failing condition, and the Buffalo Street R. R. Co., could not be considered prosperous. Nevertheless, in 1868 an act was passed authorizing the dissolution of the Niagara Street R. R. Co., and the sale of its property, and the Buffalo Street R. R. Co. purchased the property, and both roads were operated by the Buffalo Street R. R. Co., Mr. Watson assuming the responsibility of carrying this new burden.

There were other gentlemen who should be honorably mentioned in connection with this purchase and the management of the new company, to wit: Dr. Walter Cary, Judge Joseph G. Masten and Gibson T. Williams. They gave to Mr. Watson the benefit of their money, their counsels and their labor; but not long after 1868, Mr. Watson became the owner substantially of all the stock of the Buffalo Street R. R. Co. In 1870, he procured the incorporation of the Buffalo East Side Street R. R. Co. I remember talking often with him about this enterprise, and asking him how he expected to raise the money to carry it on. He said that as long as there was a cent on this earth which could be borrowed he should borrow it, and that he would look to the future for his pay. But the future that he spoke of was much farther off than he anticipated. The panic of 1873 struck the city and its shadow was not entirely dispelled much before 1880; but Mr. Watson never quailed. His labors were unceasing, and income increased. Ultimately every past due cent of the company's debts, as well as Mr. Watson's own private debts, with interest in full were paid. No man ever lost a dollar of principal or interest by trusting Mr. Watson or the Street Railroad companies; but Mr. Watson himself, physically broken down by continuous toil; finally fell a victim to his devotion to the Buffalo Street Railroad companies. At the annual election held on the 7th day of June 1880, he was elected president of the Buffalo Street R. R. Co., for the last time, and on the 17th day of June, 1880, the Board of Directors of that company adopted resolutions lamenting his untimely death, which had occurred between those two dates. He never reaped the reward of his labors. He never enjoyed even the sight of the promised land excepting through the telescope of his imagination. It should not be understood that Mr. Watson died of a broken spirit. His heart, so full of love to his family, so devoted to his friends, and to the public welfare, was as firm to the last as lion-hearted Richard's.

It is a curious, and at the same time so far as relates to him personally, a sad story to tell, that almost immediately after Mr. Watson's death the times and earnings of the Street Railroad companies began to improve rapidly. Aided by large advances of money made by Mr. E. G. Spaulding, and by his counsels, and by the labors of Mr. Henry M. Watson, Mr. S. S. Spaulding, Mr. Edward E. Edwards, the superintendent of the roads, and their other employees, and by always devoting the net earnings to improvements, the property finally attained a solid value. And when a few years ago Buffalo received the extraordinary impetus which it has since enjoyed, the street railroad companies' prosperity increased with the prosperity of the city.



I am sure that when our citizens come to understand the demands which have constantly been made for extensions and equipment, and reflect upon the difficult circumstances under which these demands have been met, they will not only exonerate Mr. Watson and his family from any lack of diligence and enterprise, but will fully appreciate their exertions to satisfy the public, and I hope also the character of my dear friend Stephen Van Rensselaer Watson.

Finally, the hour came when the success of these enterprises was assured. The growth of the city became so rapid that it was quite apparent that the affairs of its street railroads had become too extensive and onerous to be undertaken by a single family; and accordingly they made arrangements to sell their interests to the enterprising and wealthy gentlemen who propose hereafter to take charge of the present street railroad systems of the city of Buffalo. They have entered into the labors of Stephen Van Rensselaer Watson and his friends, carried on for so many years amidst the clouds of adversity, under a clear and auspicious sky, and I know that every man present, as well as every citizen of Buffalo, will join me in expressing to them our sincere congratulations, and our earnest hope that they may reap the rich reward due to skillful labor and intelligent enterprise.

Mr. W. J. Carruthers-Wain, responding to the toast of "The Tramway's Institute," said:

At this late hour it would ill become me to detain you with any lengthy speech. I have observed that the sentiment coupled with this toast is: "One touch of nature makes the world kin." I have been trying ever since I have been in this country to think what can possibly be that touch of nature in the tramway world which makes the world kin. I have, sir, I think, discovered it. It is the nickel. I am glad, sir, indeed, to have this opportunity of appearing before this distinguished company and telling them how much I admire and appreciate the American system of tramways. I have surveyed them from almost one extreme of the great continent to another. I have seen them from New York to Tacoma, and from Tacoma to Pueblo, in pretty nearly every city en route. I think I have learned something to take away with me for the benefit of we poor benighted people in the old country. Before I sit down, I want to say that nothing can tend to promote the successful conduct of tramway enterprise and tramway management so much as the proper conduct of an association of this character. This is a great association, conducted on large and liberal lines: it is a great and overwhelming success. No one who looks around this room can doubt it. I trust it may continue to be a crowning and overwhelming success, which it ought to be, and that you and your successors may continue to look around upon an assemblage as magnificent in character as this; and that the tramway interests, not only in this country, but in all others, will go on with increased prosperity; and that we, from one side of the ocean, may continue to shake hands with you on this side and always congratulate ourselves on the continued increase and prosperity of the tramway systems.

Mr. Henry W. Box, speaking to the toast of "Street Railway Etiquette," said:

The sentiment printed in connection with the toast has come to my knowledge the first time this evening. Had I known of the sentiment before, I might have spoken more relevantly than I shall to-night. I have assumed all the way through the local committee assigned me this toast because they were very sure I knew nothing about the subject. I wanted the committee to assign me the toast of the City of Buffalo; that is something worth accepting by a man of my proclivities. If I had the "City of Buffalo" I could speak of its wonderful development, of its unapproachable climate, the enormous fortunes that have been made in real estate and the greater fortunes now ripe and ready to fall into the lap of all those who buy real estate in Buffalo; and thus, mingling a little business with much pleasure, I should perhaps be able to sell a number of East Buffalo lots to gentlemen present from the now dead cities of Minneapolis, St. Paul, Chicago, Cleveland, Pittsburgh, Toronto and Brooklyn. I actually thought I could tackle "Lightning in Harness," and could do it justice, because nobody knows much about it, and one may indulge in the most gigantic and extravagant predictions, and no one would dare to dispute him, unless he happened to be too highly charged with "Jersey Lightning." I do not, however, want to evade any duty assigned to me on this occasion. A distinguished United States senator gave utterance to the sentiment that the golden rule had no place in a political campaign. Had he said it of a street car, there would have been none to dispute him. Some writer in the North American Review has had the tenacity to speak of women as "the mannerless sex," and he proceeds to arraign them for being superlatively selfish, disgracefully inconsiderate and exasperatingly insolent, and says that woman's code of manners toward her own sex would not be tolerated for a moment among men. The charges are altogether too general in my opinion to accomplish any good whatever. That women violate the rules of etiquette in the street cars more frequently than men I am not prepared to affirm, nor will I attempt to deny. I know that we are all too selfish, and nowhere is the mean side of a man's character more distinctly developed than in the street car. A local writer has recently told us that woman and the street car were never made for each other. I have often wondered since reading that article who he imagines the street car was made for. It is mighty certain that men have very few rights in the street car when the gentler sex is on board. Woman has

no doubt whatever but the street car was made for her, and she gives unmistakable evidence of attachment to it by seizing all she can, and holding fast to all she gets; and this conduct is fostered by what is called the gallantry of men, who so readily surrender their seats in the street car to women simply because they are women. But, gentlemen, all selfishness exhibited in the street car is not confined to one sex, and any man who charges in a wholesale manner that all women are deficient in generosity and consideration for the wants of others, is either very much prejudiced or is a very superficial observer. We must admit with regret that our own sex too frequently show a disregard for the rudimentary principles of politeness and that they must be stamped as ill-bred, while we must also admit, with pleasure, that there are women so watchful of the rights of others, and so gentle in the assertion of their own, that their conduct deserves little less than veneration. I have seen within the past week, with her five year old non-paying child, of course with his feet on the cushion, a woman occupying two full seats in a crowded street car, while a sick and feeble woman at her side was compelled to stand. I have also seen, within the past week, a young woman surrender her seat to a man in feeble health and bearing in his countenance unmistakable signs of a speedy departure to that "bourne from which no traveler returns," when not a man in that whole car had politeness or thoughtful consideration enough to give a seat to the invalid. Some writer, in describing the power of man, eloquently says: "man comes to an abyss, bridges it, and passes on; he comes to the mountain, tunnels it, and passes on; he comes to the sea, where waves mockingly kiss his feet, builds a ship and passes on; he comes to the street car, takes a survey, and passes on—to the platform."

The toast does not quite advise me as to whether I am expected to lay down a code of rules for the government of well bred people in the street car, or whether I am only to speak of the conduct which prevails between people who use the street car. I know a great many think, in the scramble to get a place in the street car, that one rule alone should govern, viz.: Every man for himself and the devil take the hindmost. It is very difficult, ladies and gentlemen, to lay down any strict rule for the government of all people who have occasion to use the street car. Time and place are such important factors to be considered. Conduct which would be regarded as perfectly natural in the wicked city of Chicago, in the quiet, well ordered, and God fearing city of Buffalo, would certainly be regarded as an outrageous infringement upon personal rights. I read the other day of two men entering a Clark street car in Chicago and relieving a passenger to the extent of a gold watch and thirty-five dollars. Now, no self respecting Buffalonian would be willing to accept relief in so public a place however poor in spirit he might be.

Bill Nye, in an article on marriage festivals, comes to this very sage conclusion, that "marriage, when not carried to excess, is a wise provision and a sacred obligation." "His advice is marry your opposites, as far as possible, especially as regards sex; you will never regret it." So I may say with reference to the conduct of one person to another in the street car. Be polite, and if not indulged in to excess it is a most desirable trait, and the man or woman that shows it "will never regret it," but I deny that it is any evidence of politeness for a man to surrender his seat to a woman *simply because she is a woman*. There may be a hundred valid reasons why the man should retain his seat, and not one why he should surrender it; and I have often seen many well bred women absolutely refuse to take the seat offered her by a man perhaps severely fatigued with the labors of the day. These considerate women probably comprehend the situation. I hope more will; it is devoutly to be wished.

I am indebted to Mr. Murray Verner, the new manager of our street railroads, for a few rules which he believes are very important, and no code for the street car would be complete without them. He is unavoidably absent this evening, but he has prepared for me advance sheets of the rules to be put in operation here the first of next January.

I. All passengers on the street cars with umbrellas, will be expected to extend them across the aisle; it will furnish athletic exercise for some passengers, and amusement to others.

II. Passengers not having an umbrella, and especially male passengers, will be required to cross their legs so that their feet will extend across the aisle in a manner to interfere with the free ingress and egress of other passengers; contact will improve a dirty boot.

III. Every person paying a nickel has the right to consider that he owns the car, and expect to be carried as comfortably as though he hired a carriage.

IV. Every passenger whose fare the conductor misses is under no moral obligation whatever to make it known, for it is perfectly legitimate to cheat a corporation, and besides, if he still has the nickel, he can buy a glass of beer or a glass of soda water, both most refreshing, taken at the expense of the street car company.

V. All ladies are expected to sit sidewise, and two ladies side by side, are expected to occupy the place of three. To avoid embarrassment, ladies thus seated are requested to look out of the window, and not notice the passengers standing, who have paid for the seat.

VI. All children, too young to pay fare, are expected to make up this deficiency by standing on the car cushion, taking up a full seat, which has been paid for by a standing passenger, and wiping his feet on the passenger next to him. This will aid the passenger to cultivate that noble Christian virtue, patience.

VII. The moment a vacancy has been created by a passenger leaving the car, the two adjacent persons are expected at once to close up the gap, and prevent anyone from occupying the seat.

VIII. Ladies are prohibited from thanking any gentleman who has given up his seat in the car, and they are expected to accept the courtesy as a matter of course, thus showing their superiority over man, and a full appreciation of their undoubted rights in the street car.

IX. Every gentleman that gives up his seat in a street car to a lady, must sneak away like a "guilty thing," and deny the lady the opportunity to thank him. This is so satisfactory to both.

X. No young girl will be expected to surrender her seat to one of her own sex, however encumbered or decrepid, so long as there is a man in the car seated.

XI. Very large fleshy persons, in an open car, must always take the end seats, and compel passengers to climb over them.

N. B. The task is rendered more difficult by the passenger crossing his legs.

XII. A female desiring to take an open car must be allowed sufficient time to walk the entire length of the car, before deciding which seat she will take. If accompanied by a lady friend, twenty seconds more time must be allowed for them to decide which shall enter the car first.

XIII. The conductors are the servants of the people, and may be abused without mercy; they are accustomed to it, they are paid for it, it won't hurt them, and it will do the passenger a great deal of good, to discharge any surplus wrath which he has pent up, and cannot discharge upon anybody else without incurring the risk of being knocked down.

I think, ladies and gentlemen, if this toast was assigned to me on account of my ignorance of the whole matter, I have convinced the stupidest street railroad manager here, to night, that I have fully vindicated the judgment of the local committee.

Mr. Wyman—We have with us this evening, an old friend to whom we have often listened with delight, Mr. Calvin A. Richards, of Boston; who will now address us.

Mr. Richards then addressed the gathering in part as follows:

The hour is so late, and the journey here so long, that I hardly feel able to stand up and address you; but I should be recreant to every sense of gratitude did I not take this opportunity to thank you all for the many pleasant things that have been said to me during my short stay here. One of the most delightful features of this evening's gathering is the presence of the ladies. I believe this feature was inaugurated when I was President of the Association; and it is one of the most sensible things I ever had anything to do with. There is nothing you can do, and there is nothing you ought to do, which you cannot do in the presence of your wives. There is no place you can go, there is no meeting you can attend, there is nothing you can take up in life which is not blessed, perfected, beautified and helped by the ladies. Many and many a time, when we are weary with our occupation and perplexed and worried, desiring to give it up, and feeling we could not carry the burden any longer, we have gone home, and our long faces have probably expressed that feeling to our wives; and the words of encouragement, the words of strength, and the solicitude mingled with them, have given us courage to go out the next day and meet its duties again. I wish to thank you all again for the hand shakes and pleasant things said to me, which have made a glow around my heart beyond expression, and I trust to meet you all again.

#### SPEECH OF HON. JOHN LAUGHLIN

Mr. Toastmaker, ladies and gentlemen—My engagements have been such since I was invited by your Committee to be present on this occasion to respond to this toast that I have not had time, so to speak, to prepare an impromptu address; and, therefore, my remarks may be somewhat desultory. I will, however, make them as brief as possible. I want to say, in the first place, that it certainly is a pleasant innovation to sit around a banquet table and see so many ladies present. It is something new to us here in Buffalo, so far as my limited experience has gone, and I hope hereafter the custom will be followed. Certainly hereafter the custom will be followed here. Certainly, their presence has added much to the happiness of this occasion. If I had known there was to be a convention of street railroad men in this city, I should probably have taken up my abode in some other city, because my first experience after coming to this city, as I read about these street railroad men in the daily press, was that they were a most terrible class of people, the worst that there was on God's footstool. For years before I knew our good friend Watson, whom you have honored, and have drawn honor upon yourself also, in electing him President of your Association, I only regarded him as one of those great abhorrent things with horns. The same is true of our friend Box; the newspapers abused him so as the representative of the street railroad corporations. My idea of him before I became acquainted with him, was that he also had horns; and it is only in his presence now that I can believe that he has not got them.

Ladies and gentlemen, I think it has been a good thing for the City of Buffalo that you have come here to this Convention. I hope that you have had a good time here and that your memories of this city will be pleasant. I hope they will also prove in some way beneficial to you, as I know that they will to our street railway officials and to our city. I hardly know, my good friends of the street railways of this country, what to say to you on this occasion in being called to respond to the toast of the Empire State. I know that you, perhaps, in your own homes, have had a little dose of this public criticism. You are serving the public, and, of



course, receive it. I have had a little experience of that kind myself in another way since being called upon it, this district to serve the public, and I can sympathize with you. You are serving it for the nickel, and I for the magnificent sum of fifteen hundred dollars a year representing nearly four hundred thousand people.

The Empire State. What contemplations rise before us when we think of her greatness and her grandeur. It is almost beyond me to attempt to even enter the borders of her greatness on this occasion. I have heard of a story of four Americans in Paris on the 4th of July, one of them being Mr. Norton, of Buffalo. As true Americans they desired to celebrate the day, and were having a quiet dinner in a hotel there. One of Mr. Norton's friends presented the toast, "Here's to the United States of America; bounded on the north by Canada and the great lakes, on the south by the Atlantic and the Gulf, on the east by the Atlantic and on the west by the Pacific;" and they drank to that toast. Another of Mr. Norton's friends said that was grand, but it was not grand enough to describe the United States; and he said, I propose the toast: "Here's to the United States; bounded on the north by the North Pole, and on the south by the South Pole, on the east by the rising and on the west by the setting sun;" and they thought that was very good, and they drank that toast. Brother Norton, however, could not let the United States rest in such narrow bounds; and he said: My friends, I propose a toast; you have all done very well, but still you have not been broad enough in your description of the United States. My toast, he said, rising with his glass in his hand, is, "Here's to the United States; great and growing; bounded on the north by the Aurora Borealis, on the south by the Procession of the Equinoxes, on the east by primeval chaos and on the west by the Day of Judgment." In contemplation of the toast before me this evening, I feel much as Brother Norton did. The sentiment to the toast reads, "The crown jewel in the national diadem. First in wealth and population, may she also be first in the arts and virtues which constitute the true grandeur of nations." Yes, greater than her sister states in wealth, in the development of industries and inventions, in population, and in all that makes a state great. She still bears no enmity or marks of undue pride on account of this greatness. New York has furnished to America many of its greatest men. During the early, trying days of the Republic many of the statesmen who shaped and framed our Constitution and carried it successfully into execution, came from the Empire State. He who drafted it, and to whom more than any other we owe the fabric of our nation, Alexander Hamilton, was a native of New York. Roscoe Conklin, the greatest orator of his day, you all know and recognize as a New Yorker. William H. Seward, one of the greatest statesmen also of his age, was also a native of the Empire State. I could go on, my friends, for considerable time and enumerate the great men that this state has furnished to the nation and the world.

Among the earliest provisions of our state government was founded an educational system, and to-day we have, perhaps, as good, if not the best, common school system that is known in America. Institutions of learning are scattered all over our great state. We have a free and untrammelled press that is an honor and a credit to civilized journalism. We have industries that are known all the world over, and we sell to all the markets of the world, and our products are consumed in every quarter of the globe. We have to-day three candidates for President of the United States, natives of our state, and two, at least, we intend to nominate, to add to the president that you have to-day made. We have the marvels of the nation within our borders. Our Hudson river on the east, excelled by no river in the world in scenery, in beauty, in grandeur. Also our Erie Canal, connecting the great inland fresh waterways with tide water at the Atlantic, and the great cataract of Niagara thundering and roaring on our western border, one of the most natural sights and phenomenon in the world.

Ladies and gentlemen, without dilating further upon this theme, because it is one which a person might talk upon all night, I will say that the Empire State welcomes you to her shores, and the municipality of Buffalo makes you thrice welcome, and wishes you a pleasant sojourn in our beautiful city; and when, forsooth, you may tire of your visit, or your duties may call you away from us, she bids you God-speed and a safe return to your homes and your families.

Mr. Wyman then introduced Mr. Henry M. Watson, the president-elect, who said:

Mr. President, Ladies and Gentlemen:—This country once had a president who was noted for the shortness of his speeches. He was so popular that the people elected him to a second term and talked of giving him a third. He has passed away now and they are building a splendid monument to his memory. I read history for profit.

While I believe in the one year term principle, so far as our Association is concerned, and hope when my official career is ended, and you say "Well done, good and faithful servant, enter thou into the joys of the ex-presidency," I naturally desire that the year of my administration shall be a progressive and prosperous one for you all. It has been a great pleasure for me to welcome you to Buffalo; and I trust that in all our labors of the coming year I may have your cordial co-operation.

The "Street Railway Press," was responded to by J. H. McGraw, of the *Street Railway Journal*, as follows:

Mr. President, Ladies and Gentlemen:—You all have heard of course what an easy thing it is for a newspa-

per man to make a speech. In a great many cases it is too easy. The trouble is that they sometimes talk too much and say too little. In my case I have prepared a hundred pages of manuscript, but as our good friends from Buffalo here, have taken so much time, I am sure you will feel obliged to me, by using one page and omitting ninety nine. This I will do briefly.

It seems to be with the speakers who preceded me the proper thing to-night that the ladies should be made the chief topic of discussion. I am glad that this is so, at the same time, had I known that this was the peculiar style of Buffalo, I should have arranged my toast differently, as there is no subject on which I like to talk better than toasting the ladies.

You have heard a great many things here to-night, some of them no doubt are true. You have heard what an exceedingly fortunate thing it is to be a street railway man, and if you believe even a small part of the good things that you have heard in regard to this, you cannot blame me when I say I was very anxious when quite young to be a street railway man.

Thinking that providence had destined that I should do some service to my fellow citizens as a street railway man I cheerfully girded up my loins and came up to Buffalo to pass the necessary examination, and between you and me, I hope I shall not have to pass such an examination when I come to enter the next world. Oh! how Col. Watson did examine me. He examined me exteriorly and interiorly, posteriorly and anteriorly, fore and aft; it seems to me that I feel the pummeling on the anterior and posterior now. It seems to me that he looked for a wart in the place where a mole ought to be. I was stripped and kneaded and rounded and thumped and contorted and squeezed, (something I suppose as the daily press of Buffalo has been doing with him.) My modesty was burglarized, and my hope of a blessed immortality beyond the grave almost pounded out of me. The very thing for which he rejected me at last, for he did reject me—my eyes, he could have seen at first. I passed through the trying ordeal and was left. Disappointed but not disheartened, I next went to the office of a technical paper. I told the manager that I was rejected on an examination at Buffalo for driver, and asked him if I hadn't better try Mr. Wyman, of the "Belt Line" in New York next. He told me he thought the time was ripe to start a street railway paper, and I might do for an editorial position. I told him I did not know the business, and could not pass an examination. He replied, "Young man, I have been a newspaper man for over twenty years, and I never heard before that a man had to know anything to edit a paper."

Ladies and Gentlemen: My subject is now fairly opened. I accepted the situation, and am now the owner of the paper. I have, my friends, always felt that had I been admitted to the ranks of street railway men at that time that in the list of presidents, or at least in the list of those who think they ought to be presidents, might be found my name, but it was fated not to be. I have, however, never made any public exhibition of my magnificent failure to be famous. Indeed I have always kept it a profound secret, and only intrust it to you now in the sanctity of this great assembly, that as honorable men and women, you will let it go no farther.

I go thus into detail to show you that the qualifications fit me to represent the street railway press here to-night, were in "posse" if not in "esse." In observing the past history tells us that the earliest papers, both in the old world and the new, were technical papers, or at least had marks indicating a prominent trade, and that magazines and newspapers per se are the children of the technical press, and what is more, I shall show you that one of the very earliest papers show marks of being a street railway paper.

The very first advertisement discoverable was contained in an early number of an English newspaper called the "Imperial Intelligencer" published in 1648, and had reference to the theft of two horses, and the first regular newspaper in America, the "News Letter" of May 1st, 1704, contained the first newspaper advertisement in America, as follows:

"Lost, on the 10th of April last, off Shipman's Wharf in Boston, two iron anvils weighing between 120 and 140 pounds each. Whoever has taken them and will bring or give true intelligence of them to the postmaster, shall have sufficient reward."

Are not the words—"horse" and "anvil" prominent in trade papers to-day, and do they not prove what we have said above?

Now as further proof that these papers are the only ones that have survived, we state that the first newspaper printed in America was issued at Boston, September 25th, 1690, but it immediately attracted the attention of the colonial legislature, which declared its publication contrary to law, and as it contained "reflections of a very high nature" they prohibited its further publication.

Observing the present, methinks I hear you say that it is very different from the way the daily press is handled to-day. This incident furnishes a text upon which I beg to remark that street railway men should distinguish between the tone and functions of the technical press and the daily papers. It is a truth, you know, that every man's farm touches every other man's farm at the centre of the earth, and so it is that every street railway company may touch every other street railway company through the papers devoted to this subject. Our interests are your interests, and we desire to stand in the same light as if indeed we were a street railway company, and entitled to membership in this Association. We aim to tell the truth and in no way to distort facts.

I desire not to be unjust in any particular to the daily press or the reporters, as they of course are all "Jolly GoodFellows," and especially have they done well for the

Association here in Buffalo, but it so happened that often times in the past they had not risen to the importance of the subject in discussing matters of interest to street railways and especially in reporting the meetings of the Association. Some of those who have reported our meetings in the past, well I suppose the difference between a man and a reporter is that the latter is a boy, and reminds me of the very young clergyman who once upon a time petitioned the King of Prussia for a very important post under government. The King, having read the document was greatly vexed that so young a man should have the presumption to ask for so important a post. He returned the document with a note, saying—"Read 2nd Samuel, 10-5." The young man in haste opened his Bible and read "Tarry in Jericho till your beard is grown." The ridiculous statements made by some of the daily papers in reporting our work would merit the banishment of the writer to Siberia for life, were it not done with the best intentions.

Here is a sample—Speaking of a certain new motor, it reads:

"The new armature is a dandy. The special strong point is the new method of winding, which is done by inserting small wooden plugs between the wires, which keep the currents from running together and tearing up things generally."

I know of no business in which the managers and directors are brought into such close relations with so many of its patrons, as this line in which you gentlemen are engaged nor one which gives such personal satisfaction as should come to you from the consciousness of conferring daily benefits upon so many people, nor need I add, one in which the press, both daily and technical, ought to give their hearty co-operation, for the street railway companies are working for the good of the city in which they are located, as well as their own interests, to the great benefit of all concerned. Who is there, may I ask, who can stand at the evening hour at the business centre of any of our great cities, when the work of the day is over, and watch the thousands of tired men and women being carried safely and regularly to their homes by street car service, and not bless the men who have provided such a service. I admit that it is so regular and so cheap that it is not appreciated, and that when from accident or other cause there is a break, a howl of indignation and censure is heard, but this need not be taken to heart, it is a true measure of the value of the service.

Conceding to you a great satisfaction in the consciousness of doing work that benefits others, we of the technical press, are also glad to state that we take great delight in our work—furnishing as we do, a medium by which inventors and dealers can present their wares directly to the users, and by which all are regularly informed of the latest and best practice in all parts of the world, we can but feel some satisfaction in our work and the more, from the frequent evidences given, both by the street railway companies, and the advertisers, of their appreciation of our work.

We know that the managing director or superintendent employed by a company finds himself at times confronted by two interests, and sometimes conflicting interests, that of the patrons of the line and that of the moneyed investors, and he may be unjustly criticised by one or the other, but he will usually serve both interests by favoring the patrons. The position of manager of a technical paper is sometimes like that of a superintendent, for he stands as it were between the advertisers and purchasers, and like him he is subjected to unjust censure in case he fails to criticise from another's point of view, or gives special prominence to the other fellow or exploits a system of traction different from any already in use. So far as the paper which I represent is concerned, the business is divorced as far as possible from the literary department, and my associates are instructed to write in the interests of street railways at large, and to always present the merits of useful inventions, giving the facts as we see them. The progress we have made is but the record of your progress, and we feel that a current number is not as good as the last, unless it is better, and this we intend shall always be our motto.

Before taking my seat, I wish to congratulate you on the rapid growth of the street railway business, becoming as it has such a prominent factor in our national development and especially do I congratulate you on the progress of mechanical traction, which raises the business to a much higher level than formerly, and gives opportunity for greater intellectual development on the part of the managers.

In this connection we ought not to forget the debt we owe to manufacturers and inventors to whose persevering efforts the progress just noted is largely due. We depreciate the practice of some in ridiculing inventors, and calling them "craaks", and treating them as though they were the enemies of the human race. Our attention is often called to impractical schemes, but rarely do we find a design that does not possess some merit, or that does not suggest an idea that may be of value in some direction, hence we say, always encourage inventive genius of the age, by giving to every one who comes with a new device, respectful attention at least. There is still plenty of room for improvement in the street railway field, and nothing that is needful is impossible. Tell an engineer or an inventor what you wish to accomplish, and give him a "Banker's Order", and he will do it every time.

Buffalo has treated us royally, for which the hearty thanks of the technical press are due. May the "Queen City" of the lakes ever prosper. May all her people, including the daily press, give justice to whom justice is due. May the genial president of the street railway company, now the honored president of our Association, and his associates, find their sure reward in the consciousness of a noble work well done.



Ladies and Gentlemen, I thank you for your kind attention.

Mr. Edwin Fleming, of the Buffalo Express, responded to the toast "The Press," in part as follows:

Mr. President, ladies and gentlemen—I think I can see from the expression of your countenances, and your general movements, that you are thinking that Mr. Watson's speech was really the speech which should have concluded these exercises. I can not be deceived in that. I know that you would be very glad to excuse me from any extended remarks about the newspapers or about street cars or about motors or automatic couplers, and all that sort of thing. The newspapers have been assailed this evening, as having described Mr. Watson, and Mr. Box and others as being creatures with horns, and while we do not like to be attacked without replying, I desire to let that pass, without ill feeling and without resentment; and to express to you, and to the Buffalo Street Railroad Company, and its officers, and to you all—the officers and representatives of all the street car railroad interests of the United States, the great pleasure that the Buffalo papers have had in having you hold your most notable convention here, and we Buffalo newspaper men express to you our thankfulness and our gratitude for your presence here, because the Buffalo people feel so. As newspapers we represent, or we think we do, and we try to, the feelings, the aims and the hopes of the Buffalo people. I do not think I got too far in saying that we appreciate highly the honor you have done us in selecting Buffalo for your convention this year, which I hear spoken of as being one of the most notable conventions in the history of your organization.

In regard to street railroads, some frank talk has been here, and at times, as a representative of the newspapers I feel that there are nearly always two sides to a question. I am reminded of having read in the newspapers somewhere of the great wickedness of street railroad presidents, and street railroad managers, and even street railroad attorneys; but if this is all true, that they are so very, very wicked, it is good illustration of the saying that: "Though sin is ugly, she knows how to fix herself." It must be a fairy tale; because, in looking around to-night I must say that a more benevolent-looking and more public spirited looking company of gentlemen and ladies, I have never before seen. A considerable portion of the trouble in the lives of newspaper as well as railroad men comes from the grumbler; but in many instances he does a work which could not be reached in any other way. It is good for all of us to be open to criticism, and thereby some of our faults may be corrected; but as the newspaper is usually the avenue of the grumbler's criticism, it has come to be considered that newspapers and railroads are not friendly. The newspaper itself is not exempt from the attack of grumblers; perhaps the newspapers and the street railroads are the two things in our daily, practical life in this country that are subject to the most criticism. The more you think about it, the more it is apparent; the street cars and the newspapers come daily before the public; and in things which are so constantly at hand there is sure to be more or less fault finding. I can say for the press that it is trying to fulfill its obligations to the public, and there is a very clear indication that you are endeavoring to fulfill your obligations to the public. I cannot say anything further at present, except to throw out the idea that we ought, abused as we are—the newspapers and the street car companies—we ought to let the abuse go, we ought to let the unjust criticism go, and look forward to one thing only, doing our duty as we conceive it, doing our duty to aid in the progressive work, the evolution that is going on around us, make life more worthy the living in all the great cities and centers of civilization; make life more and more worth the living by our constant endeavors. There is a great deal of talk about the power of the press, exaggerated reports, but they are doing what they can, some like the boy that is fishing, they may not catch many fish, but they possibly succeed in drowning a lot of worms.

I thank you for your attention.

The banquet closed with the singing of Auld Lang Syne, and by proposal of Mr. Pearson, of Washington, three cheers and a tiger were given for the Buffalo Street Railroad Company and its officials with great heartiness.

### Ho! for Niagara.

As a fitting wind up to the magnificent hospitality extended to the delegates to the convention by the Buffalo Street Railway company almost 300 of them left Buffalo on the 11:10 train, on the 17th, to visit the greatest cataract of the world.

The party was in charge of that prince of entertainers, Col. Henry M. Watson, which alone is guarantee sufficient that the trip was all that could be desired. A run was made over the New York Central tracks to Niagara Falls station, when the river was crossed over the suspension bridge and the party left the train at a point near the horse-shoe falls.

After quite a long delay at this point, made in order to enable the visitors to fully enjoy a sight of the falls, and the beautiful scenery contigu-

ous thereto, the train backed down again and carried the party to a point near the new suspension bridge, from whence a majority of them went down under the falls, then proceeded to the Cataract House where a delicious lunch was served. After the lunch, a special train of observation cars carried the party down through the Niagara Gorge to Lewiston. The scenery along this route was particularly beautiful, and quite a number of gentlemen, Mr. Henry A. Everett, Secretary of the East Cleveland Street Railway Co., among the rest, secured a number of very fine snap shots of the scenery with their "kodaks," "detectives," and "hawkeyes." The return run to Buffalo was made in very quick time, and quite a number of the delegates left for their homes that evening, satisfied that the day had been very pleasantly and profitably spent.

### Convention Exhibits.

One of the main interests in exhibit at the Buffalo Convention was that of the Westinghouse Elec. & Mfg. Co., which showed its new motor in active operation on a Pullman car equipped with 215 H. P. motors. On this car the Hubbard trucks, manufactured by the McGuire Mfg. Co. of Chicago, were used. The car, which was in charge of Mr. Fred Pullman weighed about 24,600 lbs.

The Gold Car Heating company exhibited one of its well-known storage heaters for warming the temperature inside the electric and other kinds of street cars. The exhibit commanded a great deal of attention during the convention, and was well looked after by Mr. Mellish, who represented his company. Quite a number of street railway companies have adopted the Gold system of car heating, which system was very fully described in a recent number of the STREET RAILWAY GAZETTE.

A beautiful model of the Rae Ry. Motor and the Sheffield Velocipede Car Co. truck, of Three Rivers, Mich., was exhibited outside the Ladies Parlor by Mr. C. A. Benton, of the Rae System. Power was furnished from the Edison Circuit of 110 volts. This we believe is the first time that a single motor has been used; therefore it was no wonder that the exhibit aroused the amount of interest that it did.

One of the main features of the truck is that it consists of one frame which is carried by the boxes, and the other secured to the car body; both of the same being connected with springs. A toggle break is also another valuable feature of the Three Rivers truck.

The Peckham St. Car Wheel & Axle Co. of New York showed a number of models of its cantilever truck, among which was a new one known as truck No. 2, which is of lighter construction than the ordinary truck, and it is especially designed for use on roads where cars of lighter weight are used.

The Company also exhibited its fibrous motor axle, the interchangeable motor wheel, each of which had been fully described in a former issue of the Gazette.

The advocates of the Storage Battery system of electric propulsion had a good opportunity of demonstrating of what their system was capable when Mr. D. H. Bates of the Accumulator Co., and Mr. W. W. Griscom of the Electro Dynamic Co., took quite a large party out to Cold Springs Park, where they had a car in operation, which it is claimed has run already between five and six thousand miles. The car was equipped with ninety six of the Accumulator Co.'s cells, and the regular Edco motor.

The Connecticut Motor Co., Plantsville, Conn. had two of its constant potential motors on exhibition in the Arcade Hall, which were in charge of Mr. F. O. Rosling. The motors were superbly finished, and a number of gentlemen who had them in use for the distribution of power on their railway circuits spoke very highly of the efficiency of the motors.

The Standard Underground Cable Co. of Pittsburg exhibited a number of samples of cables especially adapted for use in electric railway construction.

A number of Ajax switches, manufactured by S. S. VanNuis of New York, were shown in Arcade Hall. It is claimed by the inventor that they are made of metal of very high conductivity, in order to secure the highest carrying capacity by the use of the least possible amount of metal. A great many of these switches are now used by Electric Railway Companies, and the demand for them is constantly increasing.

The Edison General Electric Co., with its usual enterprise, had a splendid exhibit of its motor and truck and its equipment appliances in Arcade Hall, together with a number of testing instruments, switches, etc.

Its parlor in the hotel was one of the centers of attraction during the Convention; and in fact it might almost be said that Messrs. Edward E. Higgins, Chinnock & Co., held therein a regular Phonograph Convention. From morning till night, and sometimes until the early hours of the following day, the phonograph and the graphophone were furnishing amusement to the visitors and at the same time, the finest kind of advertisement for the Edison Co. In the parlor was an immense map of the United States, on which were put 120 wafers, indicating the different cities where the Edison railways are now in operation. A model of an Edison motor car was also shown, together with a large portrait of Mr. Edison himself. Above the large map was a beautiful cluster of small incandescent lights, while outside the parlor was a large sign with the name of the Company "Edison General Electric Company" shining out thereon by means of a large number of small incandescent lamps.

On the afternoon of the opening day of the Convention, quite a large party of the Street Railway men visited Cold Springs, and took a ride on the Edison Co.'s cars, which are in regular operation on the road.

At the end of the hall, where the ladies' parlors were located, the Interior Conduit & Insulation Co. of New York had a very interesting and elaborate display of both its interior and underground conduits, together with a model of a new man-hole, recently placed upon the market by this enterprising company.

The New York Insulated Wire Co. exhibited a full line of its wires, especially those designed for the use of electric railway companies. The exhibit attracted considerable attention especially the high grade insulated wire intended for underground feeders.

A number of moulded mica insulators were exhibited by the Gould & Watson Co., of Boston.

The Eureka Tempered Copper Co. of North East, Pa., had a fine exhibit of brushes, journal bearings, segments, etc., made out of pure copper and tensile strength of 64,480 lbs. to the square inch is claimed for this metal, with upwards of 110,000 lbs. as the load of compression. The company is selling a great many of its goods for use on electric railways now.

Mr. Lemuel W. Serrell, of New York, exhibited models of the Millikin Electric Railway poles. We understand from Mr. Serrell that upwards of 6,000 of these poles have been sold within the last three months.

The Frost Veneer Seating Co. exhibited a number of its three-ply seats, panels, etc., for use in street cars.

The Tripp Manufacturing Co., of Boston, showed one of its new electric trucks in connection with the Edco company's car, and the perfect working of the truck convinced those who saw it in operation that it was one of the best trucks in the market.

The Wheless Electric Railway Co., of Washington, showed a number of very neat models, together with a very handsome catalogue descriptive of the details of the plan advocated by the company, and for which, in view of the great desire on the part of electric street railway men for an underground conduit, we predict a very brilliant future.

The J. G. Brill company showed two beautiful models of its No. 7 trucks, as also an automatic equalizer, consisting of two portions of



compound leathers with their fulcrums supported on the axle-box frame. The short arms, vertically connected by swinging links to the long, closed pivoted on plates sliding longitudinally on transverse portions of upper frame. There are many excellent points regarding this device, and of which we will have some more to say later.

The Garland Street Car Heaters, of which a great many are in active service on street cars throughout the country, were shown by the Michigan Stove company, together with the boxes in which they are placed when on the car.

A new form of car-starter and brake was exhibited by the Hercules Car Brake company, of Philadelphia.

The Adams & Westlake company, of Chicago, showed a new form of heater.

Pratt & Letchworth exhibited the Buffalo Hames and a number of valuable specialties for horse railway purposes.

Some very handsome electric head-lights, manufactured by the Steam Gauge and Lantern Co., of Syracuse, N. Y., were exhibited by Mr. E. S. Sawyer, of that company. Quite a number of these head lights are in use on the lines of the Buffalo St. Ry. Co., and the satisfaction they give is bound to cause a large demand for them.

The new street car motor was exhibited by the Belting Mfg. & Motor Co., of Chicago, of which Mr. Harold P. Brown is now the Electrical Engineer. A peculiarity of the motor is that the shaft is at right angles to the car axles, while the armature runs continuously. Rope of transmission is used, as also a new form of clutching device and levers for controlling the action of the machinery. The motor was attached to a very handsome vestibule car, built by the Gilbert Co., of Troy, N. Y. We predict for this motor a large demand.

The Okonite International Co., of New York and London, exhibited its usual pyramid of insulated wire reels, consisting of samples of the different kinds of insulated wire and cables, manufactured by that enterprising company. Okonite wire is meeting with a large and increasing demand for wiring cars and other purposes where a high grade of insulation is imperatively necessary.

The new "Standard Motor System" was exhibited by the Belding Motor and Manufacturing Co. of Chicago. This company has but recently entered the street car field, and introduces several peculiar and novel features. Rope transmission is used in place of gears; the armature is allowed to run continuously, thus having its momentum to assist in starting the car, and a neat clutching device is used to control the action of the machinery. One 15-horse-power motor was attached to a very handsome vestibule car, 28 feet over all, built by the Gilbert company, of Troy, N. Y. This car was put into actual service, taking the place of one of the regular cars on the line. Although the truck was made with a 7-foot wheel base, the car, propelled by the single motor, made the numerous short curves on the line without trouble. There was absolutely no noise from gears, and the amount of current used by the motor incredibly small.

This company has recently purchased 10 acres of ground in Chicago, with a large factory building, which is being equipped with new machinery adequate for an immense output.

Mr. N. S. Possons has been engaged for a term of years as general manager. Mr. Possons has been acting as general superintendent of the Brush Electric company of Cleveland for twelve years past, and is recognized authority in the electrical world.

Mr. Harold P. Brown, the New York electrical expert and engineer, is also connected with the company, and we are informed that a number of important contracts for street car motors have been closed. Already the company has cars in successful operation at Louisville, Ky., and St. Joseph, Mo., and we predict for the Standard system a brilliant future.

One of the most interesting of the exhibits was in Parlor F., which was occupied by the Electric Merchandise Co. of Chicago. The par-

lor was filled day and night by street railway managers, who were interested in examining the standard and special devices manufactured by this exclusive electric railway supply house. To mention the different material carried by this house, we would need to copy a list of everything needed by all systems for the complete equipment and maintenance of electric roads. Particular interest was shown in the new Stevens Positive Gravity Switch, Fuse Box for T. H. cars, Electric Headlight, Clusters, Line Breaker, England's Center Curve Insulators and many other novelties lately put on the market. The company was represented by their general manager, W. R. Mason, and Purchasing Agent, John S. Gustin, and it issued a very neat and elegant invitation for all their friends to call, an invitation which was very generally accepted by, we should judge, about every railroad man present.

A very nice display was that of Johnson company of Johnstown, Pa., which showed a number of sections of rails, girder and others, manufactured by the company.

The McGuire Mfg. Co., showed two of its new trucks, which were mounted with Westinghouse motors.

A new Ratchet Track Wrench was shown by Mr. A. D. White of Buffalo.

The Railway Switch Co., of Boston exhibited a model of its Electric Railway Switch and other specialties.

The Aluminum Brass & Bronze Co. of Bridgeport, Conn., exhibited arolley wire made of pure aluminum, and which weighed about one third that of the ordinary trolley wheels. A practical test of its fusing properties was demonstrated at the Convention, where it carried 250 amperes at the standard potential (500 volts) without showing the slightest ill effects. A number of other devices made of aluminum and some silicon bronze wire were also shown.

The Indurated Fibre Pipe Co., of New York exhibited a number of its tubes designed especially for use by electric railway companies in running its feeders underground.

Messrs. Chadbourne, Hazleton & Co., of Philadelphia, who represented the Wenstrom Consolidated Dynamo & Motor Co., made a splendid exhibit at the Convention, not only in Arcade Hall but in their parlors, and also in the lobby. A 25 H. P. Wenstrom Electric Railway motor and 50,000 watt Wenstrom generator, together with models of hydraulic gear and a new electric railway truck were shown. Their exhibit of the wooden toothed gear fully described in the Aug. issue of the STREET RAILWAY GAZETTE attracted considerable attention.

The Thomson-Houston Co. has a snow plow and snow sweeper on exhibition at Cold Springs Park, which they put in active operation on Wednesday afternoon in the presence of a great many Street Railway men (details of the measurements of the plow, etc., are given elsewhere in the present issue).

The magnificent directors' car, the property of the Short Electric Railway Co., of Cleveland, and which was built by the Gilbert Mfg. Co., of Troy, N. Y., is probably the handsomest private street car ever yet built. The ceiling of the car is finished in embossed leather, the panels of ornamental light wood. The car is 18 ft. long inside measurement and 26 ft., including the vestibule. It is mounted on a Brill truck and equipped with the celebrated Stanwood step. The windows, which are of beveled glass, are shaded with very heavy damask silk curtains, while six incandescent lamps in curious designs furnish light for the interior.

The parlor exhibit of the Short Electric Railway Co. of Cleveland, O., was complete; one of the company's 15-horse-power motors for railway service was located in the center of the room, the current for operating the same being furnished from the hotel plant. In different parts of the room, the various details of the motor were shown, in order that street railway men might examine them both individually and collectively, while upon the walls were hung a number of views of the Short Electric railways in operation in different cities.

Messrs. Emmett Bros. of New York City exhibited a number of insulated switches, pole tops, etc. The exhibit attracted a great deal of attention, and we predict for this firm the brightest kind of a future in the electric railway field.

A number of trolley wire fixtures were exhibited by Pierce Bros. Trolley Wire Co., of Boston.

R. T. White, of Boston, exhibited a number of street railway track supplies, among which may be included his apparatus for elevated and cable roads, and "the Daisy chair," which he has recently placed upon the market.

A portable railway switch of unique and practical design, was shown by Mr. W. A. Cook.

Major Carrington, of the Morton Safety Car Heating Company, of Baltimore, Md., exhibited models of his company's car heating arrangement.

A number of improved fare boxes, manufactured by the National Fare-box Manufacturing Co., of Chicago, were shown.

A full-sized working model of a new form of track construction was shown by the Gibbon Duplex Track Company of New York.

A number of pulleys, together with a belt nearly 150 feet long by about four feet in width, were exhibited by R. Hoffield & Co., of Buffalo.

An automatic switch for electric cars, was exhibited by Mr. Chas. Beach, of Albany, N. Y.

Samples of its goods, together with a number of photographs were shown by the Pittsburgh Tera Cotta Lumber Co.

The New York Car Wheel Works exhibited a number of its machine car wheels, which by the way are admirably adapted for use on electric railways.

The display of the Anti-Fire Bridge Co., of Lima, O., consisted in a model of its device.

A number of tablets containing a calendar for 1890-1891, were distributed by the Wainright Manufacturing Co. as souvenirs of the Convention.

The Stanwood Manufacturing Company of Chicago, had its step upon the Pullman Car exhibited there as well as on the directors' car belonging to the Short Company. The demand for these steps is constantly increasing, and we are informed that it is hard work for the Company to keep up with its orders.

One of the carettes, similar to those in use in Chicago, was placed at the disposal of the convention by the Russell Street Carrette Company of Chicago, through its secretary, Mr. A. M. Brickwood, and a number of the delegates enjoyed a ride out to Cold Springs in it. As previously stated in the GAZETTE, the carrette can be made a very valuable auxiliary to street railway lines, especially on streets and boulevards, through which the right to lay track is difficult to obtain.

A number of street car heaters were shown by the James Spear Stove and Heater Company of Philadelphia.

The John A. Roebbling's Sons Company, Trenton, N. J., exhibited its usual case of supplements of its various kinds of wire.

The Rowell American Switch Company of Boston, showed a model of its electric switch.

The Berlin Iron Bridge Company distributed photographs of buildings, road bridges, etc., built by it.

#### Supply Companies and Their Representatives.

Accumulator Co., New York City,  
D. H. Bates.  
Adams & Westlake Company,  
Fred. B. Jones, R. R. Willets.  
Aenckbacher Ry. Truck Co., New Orleans, La.,  
B. R. Curtis, T. H. Bowles.  
Ainslie D. A., Richmond, Va.  
W. W. Scheler.  
Allen Paper Car Wheel Co., Chicago,  
H. L. Tracy.  
Aluminum Brass & Bronze Co., Bridgeport, Ct.,  
Frank G. Stone.



- American Leather Link Belt Co., N. Y. City,  
G. H. Fisher.
- Baltimore Car Wheel Co.,  
John Pugh.
- Belding Motor Mfg. Co., Chicago,  
Harold P. Brown.
- Bemis Car Box Co., Springfield, Mass.,  
Chas. D. Stearns, Geo. M. Hoadlay.
- Berlin Iron Bridge Co., East Berlin, Conn., and  
Binghamton, N. Y.  
F. K. Field, G. M. Hardy.
- Blondell Mfg. Co., Baltimore, Md.,  
Eldredge Packer.
- Brill, J. G. Co., Philadelphia,  
J. A. Brill, Payson K. Andrews, J. A.  
Hanna.
- Broderick & Bascom Rope Co., St. Louis, Mo.,  
J. D. Bascom.
- Buffalo Belting Works, Buffalo, N. Y.,  
F. Gingras.
- Carleton & Kissam, Boston, Mass.,  
W. A. Carleton.
- Carpenter-Nevins Electric Heating Co., Minne-  
apolis, Minn.,  
C. B. Hanna.
- Chadbourne, Hazleton & Co., Philadelphia,  
A. H. Chadbourne, Wm. Hazleton, 3rd.
- Collett Car Brake Co., Boston, Mass.,  
P. A. Williams, F. C. Hinds.
- Connecticut Motor Co., Plantsville, Conn.,  
O. Rusling.
- Conway, M., Brooklyn, N. Y.  
M. Conway.
- Cook, W. O., Chicago.  
W. O. Cook.
- Crowell Clutch & Pulley Co., Westfield, N. Y.,  
E. H. Dickerman.
- Dayton Mfg. Co., Dayton, O.,  
Jos. Leidenger.
- Detroit Elec. Works,  
Chas. A. Benton, Paul W. Bossart.
- Dorner & Dutton,  
W. A. Dutton.
- Duplex Indicator Co., Norwalk, Conn.,  
R. M. Rose.
- Eddy Motor Co., Windsor, Conn.,  
M. E. Baird.
- Edison Gen. Elec. Co., New York,  
Ed. E. Higgins, John Muir, Chas. E.  
Shain, Chas. E. Hewitt, T. W. Chin-  
nock, Chas. T. Hughes, J. H. Vail, and  
Messrs. Van Size, McGregor, Page and  
Ball.
- Electric Construction Repair Co., Chicago,  
Wm. Sharp.
- Electric Merchandise Co., Chicago,  
W. W. Mason, J. Z. Gustin.
- Electric Supply Co., Chicago,  
J. R. Fletcher.
- Electro-Dynamic Co., Philadelphia,  
W. W. Griscom, E. A. Scott.
- Emmett Bros., New York,  
W. I. R. Emmett.
- Eureka, M. D., N. Y.  
Edward Beadle.
- Eureka Tempered Copper Co., North East, Pa.,  
A. L. Daniels.
- Feigel Car Co., New York,  
J. W. Feigel.
- Field Engineering Co., New York,  
C. J. Field.
- Frost Veneer Seat ng Co., New York,  
W. P. Seguire.
- Fulton Foundry, Cleveland, O.,  
C. J. Langdon, T. C. White.
- Gibbon Duplex Railway Track Co., New York,  
Thomas Gibbon, John D. Ellwell.
- Gold Car Heating Co., New York,  
Frank Mellersh.
- Gordon W. H. & Co., New York,  
W. H. Gordon.
- Gould & Watson Co., Boston,  
L. B. Pierrepont.
- Greeley S. Co.,  
F. A. Magee.
- Guarantee and Accident Lloyds, New York,  
J. G. Dorrance.
- Hale & Kilburn Mfg. Co., Philadelphia, Pa.,  
E. L. Hendrick.
- Hathaway & Robinson, Cleveland,  
A. J. Hathaway.
- Holmes, Booth & Haydens, New York,  
Thos. Larbig.
- Indurated Fiber Pipe Co., New York,  
G. C. Collingwood.
- Interior Conduit & Insulation Co., New York,  
E. H. Johnson, E. R. Little, Clift. Wise.
- Jewel Belting Co., Hartford, Conn.,  
C. E. Newton.
- Johnson Co., Johnstown, Pa.,  
H. C. Evans, Dan Coolidge, W. E.  
Broughton, John F. Ostrom.
- Jones' J. M. Sons, Troy, N. Y.,  
Geo. Jones.
- Kuhne F. H., New York,  
E. L. Guy Flitz.
- La Clede Car Co., St. Louis, Mo.,  
Wm. Sutton.
- Loud H. M. & Sons' Lumber Co., Oscoda,  
Mich.,  
Geo. H. Keeling, H. M. Loud.
- Lewis & Fowler Manufacturing Co., of Brook-  
lyn, N. Y., and Lewis & Fowler Girder  
Rail Co., of Brooklyn, N.Y.  
W. H. Delaney, John W. Fowler, Geo.  
W. Meyers, and Messrs. Robert &  
Simpson.
- McGuire Mfg. Co., Chicago,  
W. J. Cook, R. A. McGuire, M. J. Hub-  
bard, Jr.
- Meysenberg O. W. & Co.,  
A. S. Littlefield.
- Michigan Stove Co., Detroit,  
F. P. McCanna.
- Millikin B. os., New York,  
Lemuel W. Serrell.
- Milwaukee Car Wheel & Foundry Co., Milwau-  
kee, Wis.,  
Harry Hunter.
- Morton Safety Heater Co., Baltimore, Md.,  
N. A. Dane.
- Murphy Iron Works, Detroit,  
O. D. Cotton.
- Murray Thos. & Co., New York,  
Thos. Murray, J. A. McLure.
- National Car Spring Co., New York,  
G. Suckow, W. A. Silver.
- National Farebox Mfg. Co.,  
J. L. Kail.
- New York Car Wheel Works, Buffalo, N. Y.,  
J. I. Ellicott, L. Gerome, P. H. Griffin, S.  
A. Jones.
- New York Insulated Wire Co., New York,  
J. W. Godfrey.
- North American Construction Co., Pittsburgh,  
Pa.,  
R. J. Mercer, W. L. Adams.
- Northern Car Co., Minneapolis, Minn.,  
R. M. Johnson.
- Okonite Co., New York City,  
T. McCoubrey, B. B. Daggett.
- Peckham St. Car Wheel & Axle Co., New York,  
E. Peckham.
- Post & Co., Cincinnati, O.,  
Isaac Kinsey.
- Pratt & Letchworth, Buffalo, N. Y.,  
O. P. Letchworth, E. P. Sears, E. L.  
Strong, H. C. Edson.
- Pullman Palace Car Co.,  
W. S. Loutitt.
- Railway Register Mfg Co., N. Y.,  
Edward Beadle.
- Randall, I. H., Boston, Mass.,  
I. H. Randall.
- Rochester Car Wheel Works, Rochester, N. Y.,  
C. T. Chapin.
- Roebbling's John A. Sons, Co., Trenton, N. J.,  
George Bailey, F. A. C. Perrine, Hy. L.  
Shippy.
- Rowell American Switch Co., Boston, Mass.,  
B. C. Rowell.
- Russell Street Carette Co., Chicago, Ill.,  
A. M. Brickwood.
- Schieren Chas. A. & Co., New York,  
E. P. Atkinson.
- Sheffield Velocipede Co., Three Rivers, Mich.,  
H. F. Probst, M. E.
- Short Elec. Ry. Co., Cleveland,  
Sidney H. Short, C. C. Curtis, J. Potter,  
D. C. Franyaer, John E. Randall,  
Sam'l Fortinbras, H. R. Kinzelbach.
- Sperry Elmer A. & Co., Chicago,  
Elmer A. Sperry.
- Standard Underground Mfg. Co., Pittsburgh,  
Pa.,  
Geo. L. Wiley.
- Stanwood Manufacturing Co., Chicago,  
F. J. Stanwood.
- Steam Gauge & Lantern Co., Syracuse, N. Y.,  
E. C. Sawyer.
- John Stephenson Co., New York,  
D. W. Pugh, John A. Tackaberry.
- Thomson-Houston Elec. Co., Boston,  
Winthrop Coffin, Geo. W. Mansfield, W.  
J. Clark, A. H. Sherwood, F. E. Knight,  
Norman McCarty, R. C. Wiggins, H. I.  
Cazill, A. A. Glazier.
- Union Electric Traction Co., New York,  
Mr. Neftel.
- Van Nuis, C. S., New York,  
C. S. Van Nuis.
- Volk Cable Crossing, Grip & Car Brake Co., St.  
Louis, Mo.,  
Dr. K. Morgener.
- Winstrom Co., Baltimore, Me.,  
E. L. Tunis, J. B. Groom and Messrs.  
Beals, P. A. Gowd, and Foote.
- Wales Mfg. Co., Syracuse, N. Y.,  
R. S. & G. S. Wales.
- Wallace & Sons, New York,  
Jas. Goldmark.
- Wells, Geo. W. & Co., Worcester, Mass.,  
Geo. W. Wells.
- Westinghouse Elec. & Mfg. Co., Pittsburgh, Pa.,  
F. A. Sheffer, H. McL. Harding, C. M.  
Barclay, W. G. Rose, J. M. Atkinson,  
J. E. Rutherford, J. M. Dennison, B.  
F. Stewart, C. B. Osgood, F. A. Pull-  
man.
- Wheless Elec. Railway Co., Washington, D. C.,  
Malone Wheless.
- Wightman Elec. Ry. Co., Scranton, Pa.,  
Merle J. Wightman.
- Worcester Fire Appliance Co., Worcester, Mass.,  
G. O. J. Clark.

#### Technical Journals Represented.

- "Electric Age,"  
J. B. Taitavall.
- "Electrical Engineer,"  
W. F. Collins, T. Cumberford Martin, M.  
C. Sullivan.
- "Electric Industries,"  
E. L. Powers.
- "Electric Power,"  
F. L. Blanchard, A. A. Davis, C. G. Fer-  
guson.
- "Electrical Review,"  
D. B. Dean, Chas. W. Price.
- "Electrical World,"  
Dr. Louis Bell, L. G. Hart.
- "National Car Builder Supplement,"  
John M. Reynolds.
- "Poor's Manual,"  
J. Alexander Brown.
- "Power and Steam,"  
H. M. Swetland.
- "Street Railway Gazette,"  
E. V. Cavell, S. L. K. Monroe.
- "Street Railway Journal,"  
Messrs. Chapin, Fairchild, Kenfield, Mc-  
Graw, Russell, Wood.
- "Western Electrician,"  
J. W. Dickerson, E. H. Temple.

#### Personals.

Vice-President John A. Brill, of the J. G. Brill Co., Philadelphia, was, of course, present. As is generally known, Mr. Brill has travelled pretty nearly all over the world, and the contract he closed for the famous "chicken cars," about two to three hundred in number, in the tropics, has now passed into history. When the closing of a contract for cars is concerned, Mr. Brill will always be found on deck, and if there is a street railway man from Dan to Beersheba to whom John Brill's face is not familiar, we would like very much to find out his name.

Colonel Dan Coolidge was there; just the same old Dan, jolly, smiling, hearty and hospitable as ever. On Friday night we overheard a conversation that passed between this well-known gentleman and a friend of his, concerning the friend's writing up a little sketch, giving a certain well-known railroad man living within 500 miles of the Forest City of Ohio, a terrible "roasting in his next number." Quite a heavy



bet were laid on the matter, and it was finally agreed that the gentleman would publish anything that Col. Coolidge sent in *over his own signature*. We have been patiently waiting, however, for the bet to be decided, and have about come to the conclusion that Dan will pay it himself. (How is that Bro. S. R. of C.?)

One of the first faces to greet which met the delegates on arrival at Buffalo, was that of Major Evans. We understand that the Major has secured a copyright on the arrangement of his head-gear, as we fail to detect anyone daring to adopt the same method as the Major's. Always hearty, always genial, with a good word for everyone and bad word for no one, Major Evans can be safely regarded as one of the best known and most popular among the supply men.

Among the earlier arrivals at the convention was that of Mr. C. J. Langdon, Secretary of the Fulton Foundry of Cleveland, and Mr. Thos. C. White of the same concern. Both of these gentlemen are too well known to the street railway fraternity to need further mention at our hands; let it suffice to say that they make a magnificent team, work well together in harness, and usually leave a convention with their pockets stuffed full of orders.

Mr. P. H. Hoover, who was ably representing his company, (the Standard Paint Co. of New York) made his presence felt, and left the convention with a tremendous big order for paint in his pocket. Mr. Hoover is one of those gentlemen, whom to meet once is to know for all time, and is certainly a bright ornament to the firm whose interests never suffer at his hands. Mr. Hoover's P. & B. pocket pincushion did not arrive until the eleventh hour, but he managed to get them distributed, however.

We were glad to note the return of our friend Simpson once more of the Lonis & Fowler Manufacturing Co. of Brooklyn. Mr. Simpson's long and successful business career is well known, and his return to our midst again after a long absence from the country, is an event which gives us more than ordinary pleasure to chronicle.

We were pleased to note the presence of Mr. J. G. White, late of the Western Engineering company of Kearney, Neb., but now in business for himself on Broadway, New York City. Mr. White is a clever engineer, and the overhead construction, superintended by him in different parts of the country, bears evidence on its face that it is as near perfection as any in the country.

Mr. Payson K. Andrews, who in conjunction with Messrs. Brill and Hanna, attended to the interests of the J. G. Brill Co. at the convention is somewhat of a new attendant, but his travels among street railroad men during the past year or so have won for him hosts of friends, and we sincerely agree with one of his admirers, who made the remark: "Payson is like good wine, the more you know him the better you like him."

Great credit is due to Mr. Edward E Higgins, of the Edison company, for the perfect arrangements he made for proper representation. The Phonograph scheme was indeed a brilliant one as was also that of sending the cylinders to the delegates. What the ladies of the convention would have done without the phonograph and the graphophone, and the assiduous efforts on the part of Mr. Higgins to keep them all entertained at the same time, it is hard to say, but we are convinced that, were they to meet in convention assembled a vote of thanks would be proposed in favor of the Edison company in general and Mr. Higgins in particular for the entertainment, and carried unanimously. A rather novel idea in connection with the phonograph was, when on Friday evening, a gentleman whose family resided across the water happened in to the Edison Co.'s room, and at the suggestion of Mr. Higgins, a cylinder was put into the machine, into which the gentleman himself talked as also did Mr. and Mrs. W. J. Richardson and the gentleman's wife and child. The cylinder was transmitted to London where the gentleman's father has a graphophone in his office; so the very sound of all their voices will be reproduced within three thousand miles away.

Of course Messrs. H. McL. Harding and J. L. Bartclay were present shaking hands with old friends and making many new ones.

There were many inquiries for Mr. J. A. J. Schultz of St. Louis, who has more friends in the electric railway and lighting fields, than there are sands upon the seashore.

It did our hearts good to see our old friend, Eldridge Packer, on deck again; for some years Mr. Packer was intimately connected with the Lewis and Fowler company, after which he was in Boston for a time, and now bobs up serenely as right-hand men of the Blondell Manufacturing company of Baltimore. "Here's tae you", friend Packer, and may the grandest kind of success crown your new enterprise.

Mr. C. A. Benton, formerly of the Sprague Co. and now of the Rae System, had a crowd around him the whole time in the corridor outside the headquarters of Chadbourne, Hazelton & Co. and the Edison company; and the working of his beautiful model attracted an immense amount of attention, while his popularity among the fraternity was evidenced by the cordial greeting he received at the hands of every one. Mr. Benton is one of those gentlemen of whom it may be said that he is a born cosmopolitan, whether in India, in China, in Sunny Italy, in Kokomo or in Oshkosh—whether in saddle or drosky or sleeping car, or up in a balloon, it is always the same thing to C. A. B.; and if the Rae System does not now experience a tremendous boom it will simply be because there is nothing in it to boom.

Before leaving Buffalo Major Benton closed a contract with Col. William H. Sinclair, President of the Galveston City Railway company, for four Rae generators and twenty car equipments, inclusive of trucks, and we understand that this is but the forerunner of a very large order from that now enterprising city.

It is needless to say that President Peckham, of the Peckham Street Car Wheel and Axle company, of New York, was on hand. You never find a street railway convention but what somewhere in the immediate vicinity both Mr. Peckham and his trucks are to be found.

In the securing of the services of Mr. T. McCoubrey the Okonite company gives another example of its usual perspicacity. Mr. McCoubrey's career shows that the company could have found no better man for the handling of its goods. His connection with the Crocker-Wheeler Motor company served to bring an immense amount of business into that concern, and while extending a hand of hearty friendship to Mr. McCoubrey in his new connection, we cannot refrain from congratulating the Okonite company upon their having secured the services of this gentleman.

Whenever one hears of any convention into which electric power enters in any way, just as assuredly will we hear of the presence of Mr. C. J. Field, of the Field Engineering company, of New York. Although one of the youngest electricians in the country, Mr. Field has certainly shown himself to be one of the most enterprising and energetic. He is a graduate from the original Edison company, and since he formed his new connection he has commanded an enviable amount of business. The Buffalo Street Railway company has entrusted to Mr. Field the conversion of thirty miles of its system from horse to electric traction, and the letting of the contract to him is guarantee sufficient that the work will be of the finest possible description.

Mr. G. C. Collingwood, who represented his company, The Indurated Fibre Pipe company of New York, attended the street railway convention for the first time, and, although he came there a pilgrim and a stranger, yet he left taking away with him the assurance of friendship from all sides. One of Mr. Collingwood's chief delights consists in living at his home in Glen Ridge, N. J., with his horses and about twenty-five dogs, and it is only recently that he recovered the sum of \$500 from a neighbor for the malicious shooting of one of his magnificent St. Bernards—the heaviest judgment, we believe, that was ever rendered under similar circumstances.

Mr. J. W. Godfrey, the general manager of the New York Insulated Wire company, was also a new attendant at Street Railway conventions, although there is hardly a man in the electric lighting field but what knows him. His unflinching good humor, business ability and invariable geniality endear him to all with whom he comes in contact, and we hope very much to meet this gentleman at the Pittsburgh convention in '91.

Secretary Newton, of the Jewel Belting company of Hartford, Conn., although very well known in the electric lighting field, was a newcomer at the Street Railway convention, but from the business he secured for his company, we have no doubt but what he will become a regular attendant of street railway conventions.

Needless to be said, Mr. D. W. Pugh of the Stephenson company, was on hand: No convention would be complete without the presence of Mr. Pugh.

Messrs. A. H. Chadbourne and William Hazelton 3rd, entertained in their usual delightful manner, and early and late their handsome parlors were filled with guests. In the art of entertaining, experience leads us to believe that these two gentlemen have it ciphered down to such a fine point that they have but little now to learn, yet at every convention they devise some new means of looking after their friends and arranging for them to leave the convention with nothing but the warmest feelings in their hearts (and "something warm" within their vests).

#### "Some Familiar Faces."

THE "GAZETTE'S" CONVENTION SOUVENIR. *Electrical Engineer*, New York:

Messrs. Monroe & Cavell, of THE STREET RAILWAY GAZETTE, of Chicago, were on hand looking after the interest and comfort of all. They had handsome headquarters in the Iroquois, and entertained their friends in royal style. They issued a very handsome souvenir, called "Some Familiar Faces," containing portraits of past and present street railway worthies.

*Western Electrician*, Chicago:

THE STREET RAILWAY GAZETTE, of Chicago, distributed as a souvenir of the Convention an extremely handsome little book containing portraits of the most prominent street railway men in the country.

*Electrical World*, New York:

Mr. Cavell and Mr. Monroe, of THE STREET RAILWAY GAZETTE, were on hand throughout the Convention, and were active in looking out for the interests of the visiting delegates. They distributed a particularly elegant souvenir of the occasion, containing more than a score of beautifully executed portraits of leading members of the American Street Railway Association. It was a souvenir which will certainly be appreciated by street railway men, and commends itself by the elegance of its typographical work and the unusually meritorious portraits.

Professor Badt has resigned his position with the Edison General Co. to accept another in the power-transmission department of the Thomson-Houston Electric Co., in Chicago.

Mr. C. C. Warren has, we understand, severed his connection with the Westinghouse Electric and Manufacturing Co.

Mr. J. Ward Frey has just contracted with Johnson Co., of Johnstown, Pa., for about two miles of its girder rail construction to be put in at once.

Messrs J. A. Rhombert, of Dubuque; Geo. Martin Brill, of Philadelphia; Wm. Sutton, of St. Louis; Col. Thos. Lowry, of Minneapolis; S. A. Barton and Mr. Bartlett, of Boston; Hon. Thos. Cloberey, of Kansas City; and E. R. Gilman, of St. Paul, Minn., were in Chicago lately.

The Electro-Dynamic Co., of Philadelphia, has arranged through Mr. Hood, its general western selling agent, to run the car exhibited at Buffalo convention, over some of the street car tracks in Chicago within the next week or two.

As we go to press the following reaches us from the J. G. Brill Co., of Philadelphia:

"62D AND WOODLAND AVE.

"PHILADELPHIA, October 15, 1890.

"Mr. Bernard H. Schmidt has resigned the position of Western Selling Agent for the undersigned, his resignation taking effect this day.

"(Signed.) J. G. BRILL Co."

We understand that Mr. Payson K. Andrews will act as Western Selling Agent for the company for the present, with headquarters in Chicago.



Electric Railways in North America.

IN OPERATION OR UNDER CONTRACT NOVEMBER 1, 1890.

Table with columns: OPERATING CO., LOCATION, SYSTEM, CARS, MILES. (Left side) and OPERATING CO., LOCATION, SYSTEM, CARS, MI (Right side). Lists various electric railway systems across North America.



# The Street Railway Gazette.

(Copyrighted, 1890.)

VOL. V.

CHICAGO.

NOVEMBER, 1890.

CHICAGO.

No. 11

## JOHN N. STEWART.

PRESIDENT OHIO STATE TRAMWAY ASSOCIATION.

The accompanying picture is that of Mr. John N. Stewart, who was elected president of the Ohio State Tramway Association, on Wednesday last, the 19th inst., at Columbus. He was born in the city of Cleveland, Ohio, in the year 1846, and obtained his early education at the public schools of that city. At fifteen years of age, he was appointed a West Point cadet, but declined the appointment and received a commission as Military Telegrapher and was assigned to duty in the vicinity of Washington, D. C. At the close of the war, under the auspices of the Credit Mobilier & Finance Co. he began active railroad construction of the Pioneer Union Pacific Ry; at the completion of that and the Central Pacific Ry. at Promontory Mountain north of Salt Lake City, Utah, he arranged and supervised the placing of the "last tie." The golden spike and silver mallet he placed in electrical circuit, and the driving of the last spike in this great national overland route was telegraphically announced throughout the country. Soon after he returned to Cleveland and began the study of law, but the rapidly advancing commercial interests of his native city peremptorily demanded his co-operation, and many of the now important industries of that city date their existence to his indomitable perseverance in time of need. He was for a number of years a member of the City Council, and for some time its presiding officer, and has always been foremost in the military activity of the city,—a leading member of the Masonic fraternity—G. A. R. and Knights of Pythias—is interested in street railroad systems, and, other business in the city, employs large numbers of men, and never during all the many agitations on the subject of "hours" and "wages" has there ever been any disagreement between employers and employees in any of the enterprises in which Mr. Stewart has been interested; is the individual owner and proprietor of the Ashtabula system, so unceremoniously torn up and destroyed by the City Council. Mr. Stewart's family consists of Mrs. Stewart, three sons, and two daughters.

Mr. Stewart anticipates that the ultimate termination of affairs in Ashtabula will but reflect to his credit, and has no misgivings as to the financial outcome of any such high handed piece of piracy as was nevertheless attempted (the full details of which were published in a recent issue of the "GAZETTE.") He appears to enjoy the position in which he finds himself thrown, with a whole municipality thrown against him, and his friends hope to see him win his fight in the near future, and come out of it a victor—as he undoubtedly will.

## ANNUAL CONVENTION OF THE OHIO STATE TRAMWAY ASSOCIATION

The ninth annual meeting of the Ohio State Tramway Association was held in the Hayden Bank Block, Columbus, Ohio, November 19th, 1890



Faithfully Yours  
John N. Stewart

The meeting was called to order at ten o'clock by Hon. John N. Stewart, Vice President, of Ashtabula, in the absence of Wm. B. Hayden, President.

Chairman Stewart stated that, in the absence of Secretary Lang, of Toledo, Treasurer J. B.

Hanna, of Cleveland, would act as secretary in his stead.

The delegates present, and companies represented by them were as follows:

- AKRON, Akron St. Ry. Co., W. D. Chapman, Pres't. and J. E. Metlin, Superintendent.
- ASHTABULA, Ashtabula St. Ry. Co., Jno. N. Stewart, Pres.
- CLEVELAND, East Cleveland St. Ry. Co., Dr. A. Everett, Pres.; B. Blee Gen'l. Manager. Woodland Ave and West Side St. Ry. Co., J. B. Hanna, Sec'y.
- COLUMBUS, Columbus Consolidated St. Ry. Co., A. D. Rogers, Pres.; R. E. Sheldon, Vice Pres.; E. K. Stewart, Sec. and Treas. Glenwood & Green Lawn St. Ry. Co., R. R. Rickley Vice Pres.
- DAYTON, Dayton St. R. R. Co., C. J. Ferdening, Pres. and G. W. Rodgers, Vice Pres. Oakwood St. R. R. Co., C. B. Clegg, Pres.

The following gentlemen were present as visitors:

- R. M. Johnson, of the Northern Car Co., Minneapolis, Minn.; Ernest L. Clark, Sec. Illinois Electric Material Co., Chicago, Ill.; A. H. Englund, Sec. and Treas. Electric Merchandise Co., Chicago, Ill.; S. J. Collins, of the Meaker Mfg. Co.; C. A. Benton, of Rae Electric Ry. System, John I. Beggs, District Manager, and Alexander H. Lewis, Special Agent, Railway Department Edison General Electric Co., Chicago, Ill.; C. K. Harding, President the Harding Electric Railway Co., Atlantic, Iowa; Fred B. Brownell President Brownell & Wight Car Co., St. Louis, Mo.; J. W. Cooke, Vice President McGuire Manufacturing Co., Chicago, Ill.; W. S. Wills, of Wills Electric Wheel Co., of Charlottesville, Va.; E. V. Cavell, Editor, and S. L. K. Monroe, Manager, of the STREET RAILWAY GAZETTE, Chicago, Ill.; C. B. Fairchild and F. L. Kenfield, *Street Railway Journal*, New York; W. Forman Collins, Western manager of the *Electrical Engineer*, Chicago, Ill.; John B. O'Hara, Associate Editor *Western Electrician*, Chicago, Ill.; John N. Reynolds, *National Car and Locomotive Builder* "Supplement," New York; D. B. Dean, of *Electrical Review*, Chicago, Ill.; D. Forsythe Morris, West. Manager, Millikin Bros. New York; Payson K. Andrews, of J. G. Brill Co., Philadelphia; A. W. Brickwood, President Russell Street Carriage Co.; H. F. Probert, Three Rivers Velocipede Car Co., Three Rivers, Mich.

On motion of Major A. D. Rogers, the minutes of last meeting were adopted as printed, the reading of the same being dispensed with.

Vice President John N. Stewart then delivered the following address:

Gentlemen of the Ohio State Tramway Association:—

By force of circumstances, the occasion of which I am not advised, I, your Vice President, am very unexpectedly called upon to "say grace," at this our ninth annual meeting.

Fully appreciating the many demands upon one occupying the position into which I find myself so suddenly ushered, and with so little time to fully and satisfactorily prepare a report for the year, when the tenure of office has been so short, I shall with these few words of explanation hope to satisfy you that the intention is good enough, if the length of my prayer and the "glib" of my speech is not that usually submitted by a "full fledged" President of the Ohio State Tramway Association.

The street railway fraternity have found in the past, and I hope will in the future find, that these yearly assem-



blages are a source of mutual benefit, unalloyed pleasure, and extreme profit, and an exchange of views upon the many subjects so interesting to us all, cannot fail of good results.

The troubles, trials and perplexities of almost any street railroad man, seem permanently to have forsaken him when he is in attendance upon a "Tramway convention," even the remembrance that we are upon the grounds of our "state law makers" appears to have no effect upon the spirits of the delegates, and all feel disposed to vote themselves, as does an appreciative community, the "great public benefactor of the day."

Our business seems to be one peculiarly near to the people. Our cars are their morning, noon and night method of transit between the busy workshop and the quiet home. An employer depends upon our bringing him his employes, as much as does the family depend upon our returning them at night time. Our means of doing this is through the crowded thoroughfares of the cities, where dangers beset the way, and unavoidable accidents are momentarily liable to occur. Is consideration duly allowed for such conditions of things? Evidently not, for much criticism, in public and private, criminal prosecution, and heavy damage suits follow all such misfortunes.

There is perhaps 300 miles of horse-car railroad, and 200 miles of electric, saying nothing of the cable systems, in the state; 2000 electric and horse cars, and over 3000 horses used in the transportation of people through the streets of our cities.

The value of these immense plants to the communities in which they are located, can never be fully appreciated. The proportion of taxation paid by them into the city, county and state treasuries is very large, perhaps incalculable, on account of the many different ways of taxing and assessing such property in Ohio. The number of people transported daily and yearly by us, must necessarily be many times in excess of the passenger traffic of all the great steam railroad systems of the state.

Our employes, while not so different from any other class of wage workers, are generally well paid and apparently happy, although the disposition seems inherent that "whatever the price paid," a certain amount of dissatisfaction is bound to exist, and this is without doubt largely induced by "agitators." Usually among the new and inexperienced men, the first murmur of dissatisfaction is heard, and "strikes" and their evil consequences generally emanate with, and after, some "grand high Mogul," at a salary "fit for a prince," has gone through the town on an "errand of mercy" to his own "individualism," more than to the "deluded, honest sons of toil that he claims to represent.

All may note an apparent growing disposition on the part of public legislators to inflict a manifest injustice upon, not only our, but upon all corporate interests, and in one way, if not another, use oppressive means to accomplish offensive and unlawful purposes. Such legislation usually emanates from, or is promoted by, such characters as above described; but no fear need be entertained when fair-minded and unbiased men can be induced to devote a part of their time to the consideration of public matters in which questions of vital importance to the general commercial prosperity, and grave questions of public policy, are involved.

There would seem to be a necessity for creating a responsible head for such an association as ours, whose duty it shall be to give faithful attention to all matters of a general or local character, which from time to time appear to be prejudicial to the interests we represent, and recommend and supervise such action as will prove consistent with ours and the public good.

Thanking you for your attention, I bespeak for this year's meeting the same unanimity of purpose and action that has always characterized our meetings. (Applause.)

Chairman Stewart: The next in order will be the report of the treasurer.

Mr. J. B. Hanna, of Cleveland, then read his report as treasurer of the O. S. T. A., which showed that the association was in a prosperous condition, having to their credit, after defraying all the expenses of the previous year, several hundred dollars, in bank.

On motion, the report of Treasurer Hanna was then adopted as read.

Chairman Stewart stated, that owing to the absence of the regular secretary, a report from him would be dispensed with.

Chairman Stewart: I believe it is customary for the chair to appoint a committee to select officers for the ensuing year, and select the place at which the next annual meeting of our association shall be held, and in accordance with the usual custom in that regard, I will appoint on that committee, to report this afternoon, Dr. A. Everett, of Cleveland; Mr. E. K. Stewart, of Columbus and Mr. J. E. Metlin, of Akron.

The president then announced that applications for membership were next in order. No response.

Dr. Everett: There are a great many delegates who expect to be present at this meeting that have not yet arrived in the city, and I therefore think it would be expedient for the association to adjourn at this point until this afternoon, in order that those delegates may participate in these proceedings.

On motion of Dr. Everett, the association then adjourned until two P. M.

#### AFTERNOON SESSION.

President Stewart, after calling the Association to order, said:

I am requested by the chairman of the local committee on arrangements, to say that if there are any present who desire tickets for the banquet this evening, they can procure them from the secretary of the Columbus Consolidated Street Railway Company, Mr. E. K. Stewart, who has the tickets. The tickets are \$5.00 I believe.

The first business in order is the report of the special committee, appointed to decide on location of next meeting and officers for ensuing year. That committee report that they have selected Akron, Ohio, as the place for the next annual meeting, and for officers for ensuing year, as follows: John N. Stewart, Ashlabula, president; John Harris, vice-president, Cincinnati, Ohio; J. B. Hanna, Cleveland, secretary and treasurer; E. K. Stewart, Columbus, Chairman Executive Committee.

I suppose it is necessary for the delegates to concur in the report and a motion therefore to that effect will now be in order.

Mr. Clegg: Mr. President, I am willing to move the adoption of the report of the committee so far as the officers are concerned. That part of the report suits me exactly, but I am a little bit in doubt as to the location. I am made to feel that way by the meeting to-day. I am inclined to believe that if we cannot have a successful meeting in Columbus, it will not do for us to meet in a smaller place. The rule has been to begin with Cincinnati, where we organized, and take the cities in rotation in regard to their population. From Cincinnati we went to Cleveland, then to Columbus, Toledo, Dayton and Springfield, and it strikes me, that if we keep that up and exhaust the routine, it would be well enough then to take up some of the smaller towns. I have the interest of the Association very much at heart and I think I can explain to a great measure, the reason of the partial failure of this meeting. The Toledo people are very busy with a complicated case, which is in litigation there at this time, and they are calling upon friends from other places to help them out. I have been up there once myself and expect to go again, and this keeps away some of our most active members from this meeting. Yet notwithstanding that, it seems to me that the interest in the Association is on the wane, and we must do something to revive it if we can. It does not seem to me going to such a small place as Akron, will accomplish that end. I only make this as a suggestion. There may be good reasons why we should go there, and there are others here who can probably state those reasons.

Chairman Stewart: Do you move a division of the question?

Mr. Clegg: I did not, Mr. Chairman. It is probably a little in advance of parliamentary rules for me to have said what I did at this time. There is in fact no motion now before the house, but probably the better way would be to divide the question. The officers named are very satisfactory to me, but I was only a little bit in doubt about the location, that is all.

Chairman Stewart: The Chair will entertain a motion for a division of the question, if it is desired, or a motion to adopt the report of the committee as made, and in that way we can get the matter out of the way.

Mr. Clegg: To bring it before the Association, I will move a division of the question.

Chairman Stewart: If there are no objections to the motion, we will proceed to consider the question of a division of the report.

Mr. Clegg: I move that that portion of the report be adopted, which relates to the officers for the ensuing year.

Chairman Stewart then put the motion to the Association; motion carried.

Chairman Stewart: The question is now upon the location of the next meeting of the Association.

Mr. Clegg: In order to bring that matter before the meeting, I move that we meet at Toledo instead of Akron as reported by the committee.

Dr. Everett: One of the objects in selecting Akron as the location, as I understand it, was to bring in the smaller towns and have them become

directly interested with us. If we ignore them entirely, they will not take much interest in our yearly meetings. Akron is perfectly willing and glad to have us come there, and so far as getting to Akron is concerned, I think it is even more accessible than Toledo. You can go directly from your home to Akron, without going in a roundabout way, from almost any point in the State, and that was the object of the committee in selecting that point as the place where our next meeting is to be held. The third member of the committee is from Akron, and in our conversation with him he thought it would be a good thing and interest the surrounding towns, more especially such places as Canton, Massillon, Mansfield, Alliance and other thriving cities, all of which have street railway systems now in operation. I do not think it is right that the larger towns should monopolize the meetings of this Association entirely. As to Toledo, I do not know whether they would like to have us meet there or not at the time indicated. There is no one here to consult with. We have two delegates here from Akron, and they have both extended to us a cordial invitation to meet with them.

Mr. Clegg: It is not in order to discuss this question yet, because I have moved that we meet in Toledo next year instead of Akron but there was no second to the motion, and when it comes properly before the meeting I will have something to say about meeting at that place.

Chairman Stewart: As we are not standing on ceremony we might consider your proposition at this time.

Mr. Ferdening, of Dayton: Mr. President, as I understand, there is no motion before the house. I therefore move that the report of the committee as to the place of meeting next year be adopted. I think the point taken by Dr. Everett is a very good one, and think it should be adopted as the sense of this meeting.

Mr. Clegg: In order to settle the matter and proceed with the other more important business of this meeting, I will second the motion of Mr. Ferdening.

Chairman Stewart: It is moved and seconded that the report of the committee, to the effect that Akron be selected as the next meeting point of this Association be adopted. Are you ready for the question?

Mr. Chapman, of Akron. On behalf of our people at Akron, I wish to say that we would be very much pleased to have you meet with us next year. We have a thriving and prosperous city, well equipped with railway facilities, and will try in every way to make your stay with us both pleasant and profitable.

Mr. Clegg: I did not know when I raised this point that Akron had extended such a formal and very kind invitation for us to meet with them next year. I want to say however, Mr. President, that it has not been the rule to wait for an invitation to visit any town. We have taken them just as I told you a moment ago, in rotation in accordance with their population, beginning with Cincinnati and going through. There has been a change in the mode of conducting these Associations in regard to the expense, I will admit. But the idea of Dr. Everett and of the committee, I believe, to bring into the Association these smaller towns and have them become interested in our proceedings, will entail upon them an expense which possibly might have the opposite effect from that desired by Dr. Everett, and I thought that if we would not impose this expense upon the smaller towns, who could not so well afford the burden as the larger cities, we might bring them in instead of driving them out. If we have a full meeting, as we have had of these Ohio Associations, it requires quite a good deal of attention and care and some expense to take care of us, and I do not believe in entailing that expense upon the smaller towns when the larger cities are better equipped to accommodate us. I will admit we have gone to Springfield and had very successful meetings there. I believe if our Association is prosperous and is kept up, then in a short time we can go to smaller towns to hold our meetings; but I think we should go the rounds of the five or six large cities that I have named which we know can meet all our requirements.

Dr. Everett: "What expense will be entailed?"



Mr. Clegg: I do not know of any under this new arrangement where the delegates bear their own expenses. I do not now think of any.

Dr. Everett: I think the object a good one in order to interest the smaller towns.

Chairman Stewart: As there was no second to Mr. Clegg's motion to meet in Toledo, I will now put the motion which was made and seconded to adopt the report of the committee that the next annual meeting of our Association be held at Akron, Ohio. Motion carried.

Chairman Stewart: At this point I will read a message just received from Mr. John Harris, explaining why he is not here. He telegraphs us from Toledo, stating that he has been detained at that point by Mr. Lang, and sends his regards to all the members.

Chairman Stewart: What is the further pleasure of the convention? Mr. Hanna says the next thing in order, is for the gentlemen who have been selected as officers for the ensuing year to make speeches of acceptance. I will state to the convention that I made my maiden speech this morning; and as Mr. Hanna has his prepared, and has not yet had an opportunity to deliver it, I will give way to him. (Laughter and applause.)

J. B. Hanna, of Cleveland: I have not been paying attention to what Mr. Stewart said.

Chairman Stewart: I was just thanking the convention for having given you a chance to hold the money the next year. (Laughter.)

Mr. Hanna: If the convention had announced what salary they would pay me for holding the money, I could tell better how to thank them. (Renewed laughter.) My suggestion to Mr. Stewart was that I thought it would be in order for the various street railway supply men to entertain the Convention for a short time with whatever they may deem fit; and I will therefore, in accordance with that suggestion, now give way to them.

Dr. Everett: I have heard some discussion as to the time of our next annual meeting, and it has been suggested that we meet a little earlier in the month. Wouldn't it be well to dispose of that matter at this time? Under the present rules, we now meet the third Wednesday of November. The executive committee suggested this morning that, if it be the sense of this meeting, we meet the next ensuing year on the second Wednesday of November, instead of the third Wednesday of November. That is the recommendation of the executive committee, that we meet on the second Wednesday, instead of the third Wednesday, of November.

On motion it was then decided that the next annual meeting of the association be held on the second Wednesday of November, instead of the third Wednesday of November, as has heretofore been the custom.

Chairman Stewart: I do not know of anything that would interest us any more at this time than to hear from some of the visiting attaches of the street railway interests. I refer to the supply men, and I think it would be very agreeable indeed to all of us to assign each Supply Men who will favor us with a few remarks to perhaps ten minutes' time. There may not be time enough to go around, as the supply men are in the majority (laughter), but we will endeavor to sit it through (renewed laughter).

I now have the pleasure of introducing to you Mr. Charles K. Harding, president of the Harding Electric Railway company, Atlantic, Iowa.

Mr. Charles K. Harding then addressed the Association as follows:

The great interest shown in electric traction, and recently in underground system of distribution, may serve as an excuse for calling your attention to a new American closed conduit system. It seems strange that we have thus far allowed foreigners to lead in the important branch which must at no very distant date be an essential feature of electric railways in cities.

I had hoped to be able to present this subject to you in a clear and concise form, but lack of sufficient time for preparation, and my inexperience, have made this impossible.

If, however, any gentleman present who is interested desires any information on any points not clear, I would be pleased to answer them as best as I can.

The many desirable features of electric railways are too well known to make it necessary to mention them. Still many of its great advantages, such as its flexibility, its variable speed and the facility with which it may be handled in crowded thoroughfares, are not generally known,

from the fact that there has been no practical system up to the present time admissible in the larger cities, which have the greatest need for a system of rapid transit, embodying its general features, its flexibility enabling the cars to be operated on the main and branch lines with the same power and the facility with which it can cross draw-bridges, etc., enabling the use of a number of outlets from the crowded portions of cities. Its variable speed renders progress safer on the crowded portions of the road, and a higher speed possible where the way is clear, and the economy in the operation of a road where the larger part of the business is done at certain hours, as occurs in most cities, must be greater than with any other system of propulsion.

In looking for the weak point of our present system, we should certainly find it in the transmitting line, which must be an essential part of any practical system, and its office is the direct transmission of the current from the station to the moving car. Its objections are the unsightliness of the overhead wires and poles, its dangers to other wires accidentally getting into contact, its inductive interference with telephones, its liability to damage from lightning, and the fact that its defective insulation and the demands of safety require the use of a much lower voltage than is desirable for the greatest economy in operation and efficiency of distribution over large areas.

With these objections removed most of the others could be readily overcome. A system enabling the safe use of a current of higher voltage would render practical the use of a more efficient slow speed motor with direct gearing, thus avoiding the noisy and sometimes expensive gearing necessary with high speed motors now in use, and would facilitate the use of a free running armature and a clutch arrangement, which would overcome to a great extent the shock and severe strains on the motors in starting, which cause nearly all the break-downs and burn-outs at present, except those from lightning.

It was to avoid some of these difficulties that I devised the conduit system to which I desire to call your attention. Heretofore the word "conduit" has been almost inseparably connected with some slotted arrangement, and failure, for it should be understood to preserve insulation you must exclude water, and to do that the conduit must be entirely closed, without slot or other opening through which the current is taken. In order to accomplish this result I employ a tubular iron casing, in the top of which is a channel or flanged portion in which is insulated and supported the sections of working conductor. These sections may be from four to six feet long and extend one eighth of an inch or more above the surface and are normally insulated from each other, the casing and the main conductor which extends through the lower tubular part and is entirely surrounded and embedded in insulating material.

In the end of each section of the casing or conduit, there is an enlargement of the lower tubes which forms a junction box in which is located a small electro magnetic contact making device, which when operated connects its conductor section with the main or supply conductor. One end of the winding on the magnets of these contact devices is connected through a simple switch to the adjacent working conductor section, and the other end directly to the conductor section on the other side by means of this arrangement and a second brush on the car. I employ a very small portion of the current to automatically operate the contact device and bring the exposed sections of working conductor separately and successively into connection with the main insulated supply conductor, when these sections are immediately under the car and protected by it.

In other words, I get the current to the car through the series of insulated exposed sections which are fed from the main conductor as the car passes along, and are at all other times completely insulated from the wire carrying the current, by the employment of a derived circuit in multiple-arc with the motor circuit I am enabled to use a very small portion of the main current for the operation of the contact devices, and to make the magnet of small size and wind them with iron wire, thus making the construction of the contact making devices a comparatively simple matter, and enabling them to be placed in a small closed cavity in the end of the sections, where they will be readily accessible and are adapted to be interchangeable.

It will be readily seen that the short exposed sections of working conductor will have very high insulation and prevent all but the most inappreciable amount of leakage, when it is taken into consideration that under no possible combination of circumstances can any section except those immediately under the car be brought into or maintained in connection with the supplying current.

The placing of the wire underground will remove the possibility of any trouble from lightning; and the position of the wire and the fact that the return current passes through the track rails and the conduit casing, near to and parallel with the supply current, precludes the possibility of inductive interference with telephones.

I have prepared this paper very hastily and I do not know that I have made it concise. I have stated it the way it appeared to me, and not in a way which it should appear, perhaps to one less accustomed to this particular line of work. If there is any gentleman here who wishes any further information, I would be glad to supply it as far as I can.

Mr. Johnson: Have you some cuts? That perhaps would be the better way to study it.

Mr. Harding: The STREET RAILWAY GAZETTE, of Chicago, is now preparing a set of cuts, fully descriptive of our system, and they will appear in the issue of the GAZETTE containing the report of this convention, and I will be glad to give any further information I can after the sessions of this association are concluded.

Chairman Stewart: It would probably be better that we sandwich a little practical street-railroading in with what we consider largely imaginary in the line of electrical arrangements. We have with us a gentleman who has represented the steam railroad interests of Ohio for a great many years, and is a recognized pioneer and father of the transportation of people through the state of Ohio by the steam system. But quite recently he has made up his mind that the steam railroad system of the country was a sort of back number, and he has therefore abandoned that means or transportation and gone into the street railroad business, appreciating the enormity of the street railway interests.

I now have the pleasure of introducing to you the gentleman in person, Mr. Robert Blee, of Cleveland, General Manager of the East Cleveland Street Railroad Company. (Applause.)

Mr. Blee (of Cleveland): Gentlemen, I thank you very kindly for your ovation, but I would rather have an extension of time until we meet in Akron, Ohio, for the simple fact that I have not had experience enough yet in the electrical business to know very much about it.

Chairman Stewart: You are rather young in the business to be asking already for extensions. (Great laughter and cries of "Good.")

Mr. Blee: Dr. Everett has kept me busy laying track ever since I entered his service, and has not given me much opportunity to look into the electrical part of the street railroading. If you want to know anything about steam railroads or desire to ask any questions on that subject I am at home now; and I hope in the future, and in the near future, to also be at home in the other matters. (Applause.)

President Stewart: Is Mr. Beggs, of the Edison Company, present?

Mr. Hand: Mr. Beggs stepped out just a few moments ago, but I think he will shortly return.

President Stewart: Mr. Curtis of Cleveland, representing the Short Electric system, I see is present. Have you anything to offer?

Mr. Curtis then said: I can only say to the convention that I am very glad to hear Mr. Blee when he comes before this Association, which is a street railway association, refer to its being an electric street railway convention. He speaks as though he had left steam railroading and has adopted electric railroading, that is that the horse and the mule have been abandoned and that cables are being abandoned, and that now the electric railway is synonymous with street railway.

I do not know that I can say anything to the convention regarding the Short system, with which you are not already perfectly familiar. The largest contract ever let in this country by disinterested parties, was given by a syndicate of Philadelphia gentlemen, for equipping the street railway system of Rochester, New York, to our company. That, as you probably know as well as I, was given after a very thorough and careful investigation, by experts who came to our factory, went through the works, visited our system working in different places and made their report. On the basis of that report the purchase was made for Rochester.

Now that which has heretofore been, I believe, the curse of electrical railroading in its practical operation, was the one item of repair. I see gentlemen here who know very well how much this has amounted to. In one town I am told by gentlemen connected with the road, that the repairs last year amounted to as high as \$1100. per car. When I went into the Short company, they had a road running in Muskegon, Michigan, equipped with our system. That road has been running for six months, commencing with five cars, and at the end of the six months, having nine cars in operation, and the total repairs on that road have not exceeded \$100. on all the electrical equipment. You can appreciate the advancements we have made. We believe we have got now to very near the perfect theoretical point, and we invite cordially your investigation in that direction.

There is one point that I have had called to my attention since I arrived, only proving that a man must go away from home to get information regarding one's own business. I heard remarks in the convention of consolidations. If there has been any consolidation of the Short Electric Railway, or any other railway, it has occurred since I left home this morning at seven o'clock. I do not of course know where the rumors may have started, but there is no foundation for them in fact.

President Stewart: I rather think there is a consolidation up there, and we will let Mr. Brickwood, who has a chariot up there somewhere, expose it. He says that the electrical companies up in Cleveland have taken his chariot, and in some way disposed of it, and he is rather disgusted with the proceedings, because it is not here to take this convention out for a ride. We will now hear from Mr. Brickwood of the "Cigarette Carry-all Company" of Chicago. (Great laughter.)

(Continued on page 218)



Intermediate Speed Regulator.\*

This apparatus is designed for use on line and counter shafting, to equalize the power delivered by engines, water wheels, and electric motors;

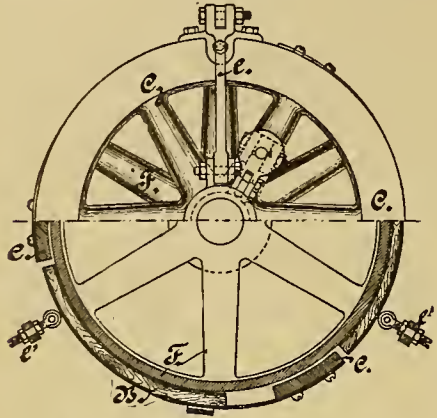

INTERMEDIATE SPEED REGULATOR.

insuring, it is claimed, an absolutely unvarying speed to electric generators; or other purposes where a very steady and uniform revolution of shafting or machinery is desired. The manufacturers especially recommend the device in Electric Railway works, where the variations of load are so great, which causes the engines to run either above or below their nominal rated speed, as the load may be greater or less as the case may be. One application of this device which is of especial interest, is its use in connection with water wheels. It is a well known

cases to be obtained at a very small expense. The description of the regulator as shown in the sectional view is as follows: The main features are a friction coupling between the driving pulley and the shaft to be driven, and a governor which regulates the amount of pressure on the friction surface. As shown, the apparatus is in the form of a counter shaft, D is the driving pulley, and is keyed on a projecting sleeve to which is attached the bands bearing on the friction wheel,

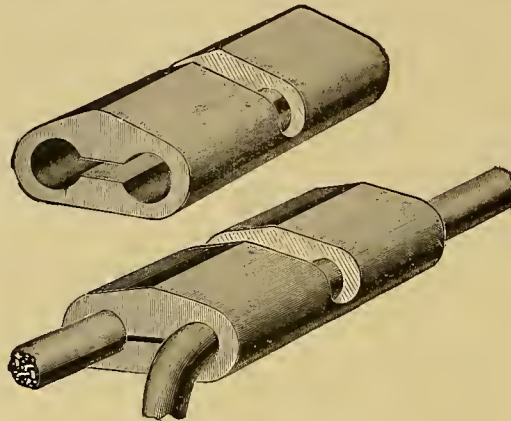

THE BRENNAN WIRE CONNECTOR,

and forming one portion of the machine; when the friction surfaces are not in contact, it is free to revolve independent of the shaft S S.

The brake shoes B which are made of leather backed by wood and sheet steel, are brought in contact with the friction wheel by the spring M,

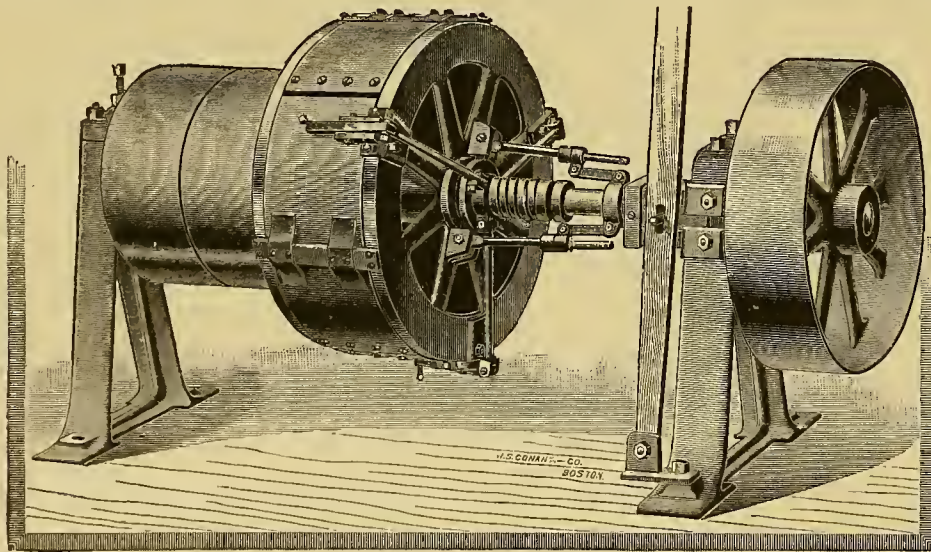

INTERMEDIATE SPEED REGULATOR.

fact that there is not a satisfactory governor for water wheels in existence, and with changing loads, and different weights of water, it is impossible to obtain the required uniformity and regularity of speed demanded in dynamos and

which acts through the levers L and L', which have their fulcrums on the carrier C, which is fast to the shaft S S. The arms of the governor G G at their fulcrums have an extension at right angle, which presses against the spring M,

It is understood that the speed of the driver D is somewhat in excess of the speed required for the shaft S S. The arms and weights of the governor when in revolution fly outward, owing to the centripetal force and compress the spring M to such extent as will allow of the proper amount of friction to give the desired speed.

The Brennan Connector.\*

Street railway constructors will appreciate the good points in the Brennan no solder connector which we illustrate this week. It is a difficult and expensive piece of work to join large wires by twisting them together. The ends of the wires to be joined are passed through the holes from opposite ends, then by moderately hammering on the top or ridge the size of the holes will be reduced and the sockets will grip the wires holding them as in a vice. When stranded conductors are used, solder may be applied in the slot shown across the face.

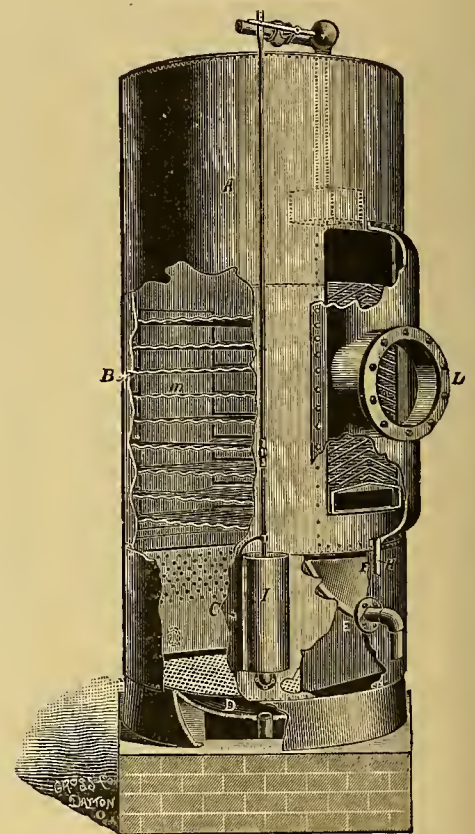

Combined Heater and Filter.†

No steam power plant using high pressure engines is now complete, from an economical stand point unless it is provided with an efficient heater, utilizing the exhaust steam for heating the feed water for the boilers; and, if at the same time the heater can be made to thoroughly purify the water so as to prevent the formation

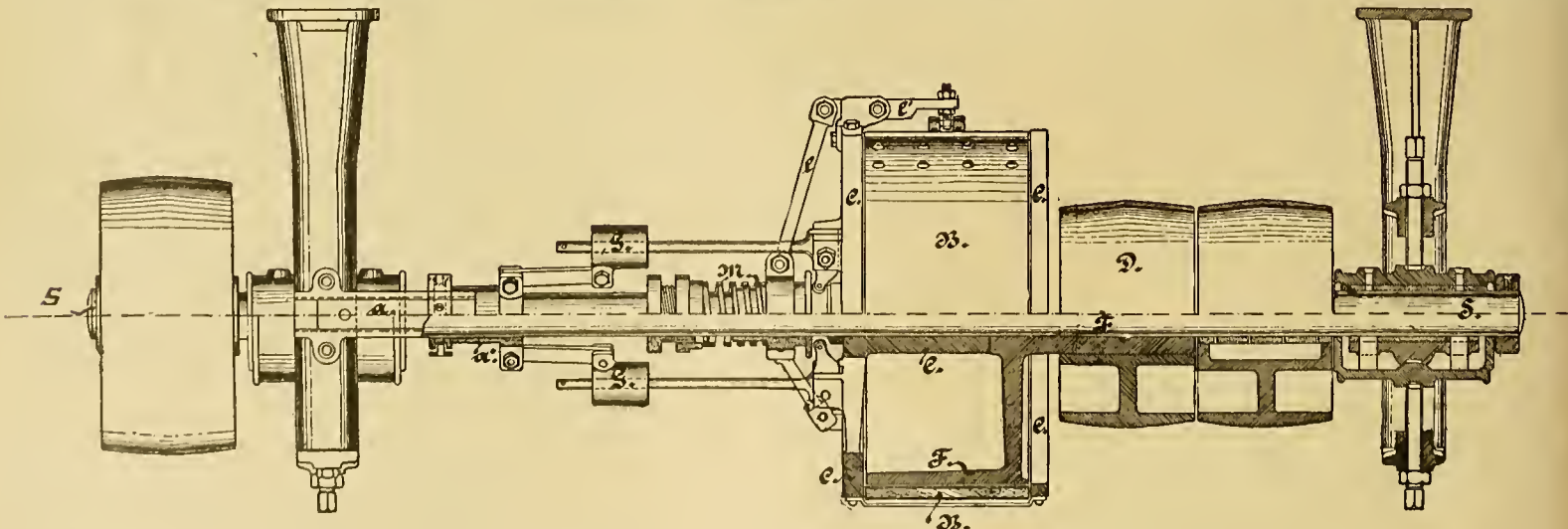

INTERMEDIATE SPEED REGULATOR.

electric generators. Water power promises to become an important factor in electric railway works, because of the possibilities of transmission which makes available a power which is in some

diminishing the pressure brought to bear on the brake shoes through the medium of the levers L and L'.

The tension of spring M and weights on the arms of the governor, are determined and adjusted according to the speed and power required.

of scale in its boilers, its economical value is thereby greatly augmented.

In this heater the manufacturers claim to offer just such a device, and they further claim to have successfully met all the objections hitherto urged

\*T. N. Foote Regulator Co., Boston, Chandler and Littlefield, Room 40 Marine Building, Chicago.

\*Pettingell Andrews Co., Boston, Mass. †Sillwell & Bierce Co., Dayton, Ohio.



against open heaters. Briefly stated the following advantages are claimed:

1. Large heating and filtering capacity, and also depositing surfaces for receiving the lime and other impurities.
2. Better facilities for quickly and thoroughly cleaning the heater.
3. Effectual devices for separating and catching the cylinder oil contained in the exhaust steam.
4. Automatic regulation of the inflow of cold water thus insuring an even and steady feed.

**Underground Conduit Work.\***

BY FRED DEGENHARDT.

To Charles Augustin Coulomb no doubt belonged the honor of discovery of that most essential necessity of modern electricity, insulation. He it was, during the latter part of the last century, who developed the fact that the momentary dissipation of electricity was proportioned to the degree of electrification at the time, and that when the charge was moderate, its dissipation was not altered in bodies of different kinds or shapes.

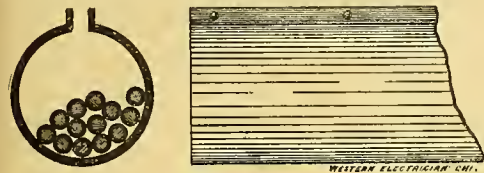

FIG. 1.

The temperature and pressure of the atmosphere did not produce any sensible change, but he concluded that the dissipation was nearly proportional to the cube of the quantity of moisture in the air.

In examining the dissipation which takes place along imperfectly insulated substances, he found that a thread of gumlac was the most perfect of all insulators, as it insulated ten times as well as a dry silk thread, and that a silk thread covered with fine sealing-wax insulated as powerfully as gumlac, when it had four times its length. He found that the dissipation of electricity along insulators was chiefly owing to adhering moisture, but in some measure also to a slight conducting power.

History as far as the writer knows, is silent as to the first attempts at insulating wires commercially, for electrical purposes, but as these remarks apply entirely to underground construction, we will refer only to the earlier efforts in

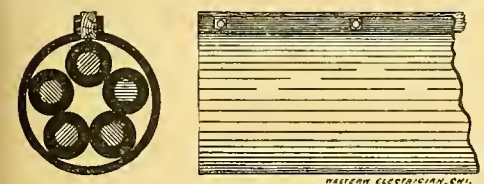

FIG. 2.

that line, accepting at once the conclusion that wires had perforce been insulated. In 1829 Prof. Henry used insulated wire for experimental work.

It was during the year 1832 that Prof. Morse first conceived the idea of underground transmission of electricity, and among his earliest plans we have a suggestion of the conduits of to-day, and as these drawings are of historical importance, I have produced two views, as shown in Fig. 1, which will clearly illustrate the general similarity of ideas, covering a lapse of fifty-eight years.

Prof. Morse adopted the underground plan without experiment, not knowing the disastrous failures that had followed like attempts in England, and, strange as it may seem, the very work in this line in this country, to-day carries with it the ear-marks of fifty years ago, and Morse's first cable was a bunch of five wires, lead encased. Prof. Morse's first cable was laid from Baltimore to the Relay House, seven miles distant, and the failure of this cable all but sealed the fate of underground electrical work; and while referring to these earlier experiments, I cannot refrain from a mention of the first at-

tempts at overhead construction, simply that by comparison, we may show that at the present day, underground as well as overhead work has been perfected only after much cost and study. The first overhead insulation adopted on the line built by Prof. Morse, shows how rudimental were the conceptions of men at that period. The insulation consisted simply of two plates of glass, between which the wire, after wrapping well with cloth, saturated with gum shellac, was placed, and over which a wooden cover to protect from rain and press the glass upon the wire, and keep

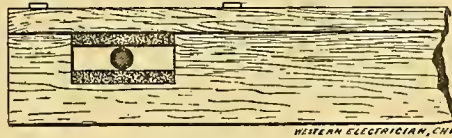

FIG. 3.

it in place, was nailed. Fig. 3 will illustrate. (This was before the door-knob era.)

It is not necessary to further cite the history of experimental underground electrical conduction or construction. Enough that the problems involved came thick and fast, and the modern applications of electricity seemed for a time to have stamped the success of the underground branch of the business as an impossibility, but as each day proved the utility of the new agent, the fact also became apparent that we would soon be walled in by a network of wires, and at this period popular clamor arose, and Necessity once more became a fond mother, and her child, Invention, brought forth in turn a multitude of offspring, among which were some that had merit, and others which had none.

It is safe to say that underground work slumbered for a period of twenty years from the date of Prof. Morse's first experiments. When, in the city of Chicago, an objectionable pole line had



FIG. 4.

been placed through a prominent residence portion of the city, the citizens of that particular section banded themselves together and selected a committee, who waited upon Prof. Barrett, of the City Telegraph Department, of the City of Chicago, and stated their grievances.

The Professor told them that the line might be placed underground but that the city did not furnish the means for so placing it. After momentary deliberation, the gentlemen composing the committee volunteered to defray the expenses, and the poles were removed, and thus the first underground work was started in the city of Chicago. Eight hundred and forty feet of 2-inch wrought iron pipe was laid about three feet below the surface, the exterior of the pipe being first treated with a liberal amount of tar and linseed oil. In this pipe two insulated wires were placed. These wires are in service to-day, and are giving as good service as the day they were placed underground.

From this date on, the underground question was agitated in the city of Chicago, and in the

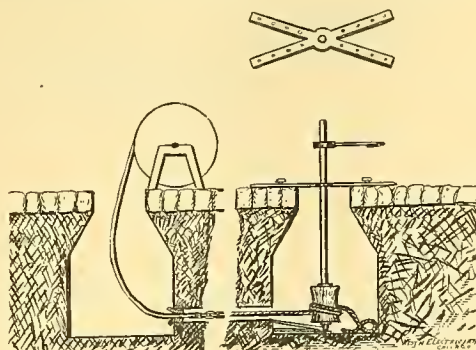
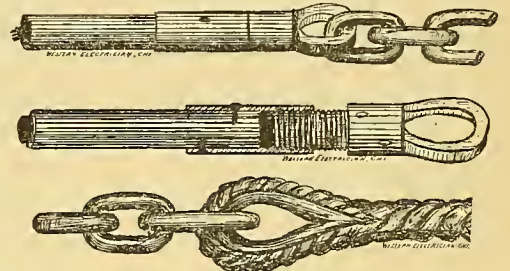

FIG. 5.

year 1883, the Common Council passed an ordinance requiring all electric conductors to be placed underground. In accordance with this ordinance, the various companies doing business

in the city, after exhausting all means to evade it, adopted various systems for placing their wires underground, and to-day, the wires so placed underground embrace all branches of the service, viz., telegraph, telephone, police, fire-alarm, electric lighting and power. In 1883 a franchise was granted to the Sectional Electric Underground Co. to built underground conduits for commercial purposes. This company built about seven miles of conduit in the business district of the city, and rented space in the same for \$1,000 per mile per duct, per year, the city being allowed the use of one duct free of charge.

The cables laid underground in the city of Chicago are placed in conduits of various kinds, viz., iron pipe laid in the earth without other protection; iron pipe laid in concrete; iron pipe, cement lined, laid in concrete and multitubular blocks of bituminous concrete about four feet long. Man-holes in many cases, are built circular in form, and in other cases, rectangular shaped, the latter averaging 46 inches in length by 40 inches in width, and are from four and one-half to nine feet deep, with double iron covers, one of



FIGS. 6, 7, 8.

which is set below the grade and made watertight by packing, the other set on a level with the street.

The iron pipe used for conduit is thoroughly reamed at the ends thus removing the burr. Conduit is laid with a pitch or difference of grade from six inches to one foot, so as to draw into the man-holes, thus disposing of all drip from condensed moisture.

The usual specifications for underground conductors, for the purposes of arc lighting, may, perhaps, not be out of place, and I give them herewith: The insulation resistance should not be less than 500 megohms per mile, and the insulation should not materially deteriorate for the

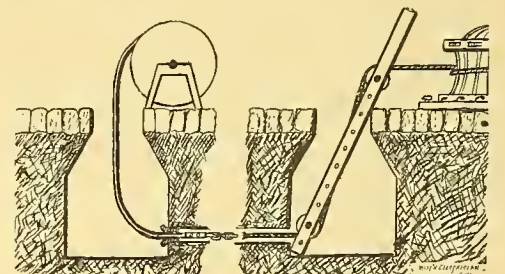

FIG. 9.

space of two years after being in service on an electric light circuit having a voltage of from 2,500 to 3,000 volts, and a current of from 9 to 12 amperes, or a voltage of from 900 to 1,200 volts, and a current of from 18 to 20 amperes.

The early method of preparing the trench for underground work, was to plough a furrow and place the conduit and the insulated wires in the trench thus made. To-day the tools and accessories are quite a feature of underground work, for after the conduits have been made and the ducts placed in most perfect alignment, so that no obstruction may be offered to the introduction of the cables, a competent corps of men take charge of the drawing in of the cables into the ducts, and I have prepared some sketches of the most essential tools, which I show in the drawings, Figs. 6, 7, 8, 9 and 10.

Moisture is to-day, as it has always been, the worst enemy of perfect underground construction, and therefore, in selecting men for the difficult work of making joints, it is well to secure those men who are possessed of that sovereign virtue, sobriety, and instill into their minds the fact that it is not how many joints they can make, but how well they can do them.

\*Paper read before the Chicago Electric Club, Nov. 3.



This class of men should be well paid and fostered, and I believe should be under the supervision of some one higher in authority than a mere boss lineman. I am afraid that many, like Prof. Morse, tried the problem without experiment, and depleted pocket-books are silent reminders of that fact. But underground electrical construction is here to-day, and here to stay, and the success that now attends it is as signal as was its failure fifty years or more ago. Electrical currents of infinitesimal potential are no more easily conducted than are those electrical giants of four or five thousand volts. To-day the user of the cables for electric lighting simply tells the manufacturer of the potential, that he wishes to carry over his lines underground, and lo! the cable is forthcoming, and with it a guarantee. The telephone manager tells you that he

FIG. 10.

must have a cable with an electro-static capacity that must not exceed a given number of microfarads and that it must contain so and so many conductors, and that its insulation must be so high and no higher, that all the conditions must be met within a given space, and the wires must be twisted in pairs, so that they can be formed into a metallic circuit if they wish, and your manufacturer goes at once to work and evolves a cable that meets these most exacting requirements. Thus on, through the whole list, transmission of power, telegraph, arc or incandescent lighting, it matters not, you simply make known your wants, aye, even whisper them, and twenty bright and active workers stand ready to take your orders, and deliver the results you desire.

Pardon my return to statistical information, but in the progressive city of Chicago alone, there is at present in successful daily operation the following enormous amount of underground electrical cables and wires, the telegraph companies alone using no less than 650 miles of wires. The Chicago Arc Light and Power Co. operates 140 miles of arc light cable and 30 miles of ducts. The city of Chicago 174 miles of arc light cables, 1,264,430 feet of conductors, made into cables from 5 to 25 wires each, and 65 miles of single wires. The city has 20,441 feet of conduit or about 100,000 feet of ducts otherwise than of iron pipe, and of the latter they have 478,087 feet used for conduits. The Chicago Telephone Co. have in operation at this date, 6,080 miles of wire, in the form of cables, or 32,102,400 feet of conductors. Their conduit system consists of 67,175 feet of main conduit, in which are 192,786 feet of duct. These conduits have a carrying capacity, when full, of 1,000,000 feet of cable, of 200 conductors. In addition to the above they have lateral conduits which measure 7,451 feet, and duct capacity in these laterals of 8,004 feet, and a cable capacity of a like amount. The Chicago Edison company has 90 miles of conductors.

### New Conduit System.

BY C. K. HARDING, ATLANTIC, IA.

The increased interest shown in electric propulsion at the recent convention of the American Street Railway Association, may serve as an excuse for bringing to your notice an improved conduit system, which, although new, is I think destined to play an important part in the solution of the problems met in the practical application of electricity, to urban passenger transportation.

As the case now stands in the larger cities, where rapid transit is the most necessary, the use of overhead wires, which have hitherto been the only practical method of operating electric street railways are prohibited; and when we consider the many objectionable features of overhead wires—their danger to life from lightning, their interference with other wires, and their unsightliness; we should not be too hasty in our judgment of the authorities who prohibit them.

In looking for the weak points of electric railways we will adopt the natural classification

made by Dr. Allen in his paper before the convention, i. e. :

1. The Central Station
2. The Motors.
3. The Transmitting Lines.

In the first division there is little more to be desired. We have good engines and efficient generators, and with a system practical in the larger cities, the increased number of cars will

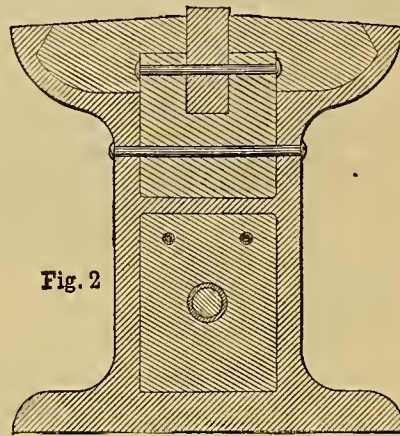

ST. RY. GAZETTE, CHI.

make the sometimes very severe variation of load relatively much less—thus avoiding the trouble at the central station.

In the second division, the electric car motors are not all that could be desired. The noisy and expensive gearing which a high speed motor renders necessary, and the duplication of motors on the same car, are objections that need not exist in a system using a higher voltage, which would admit of the use of a slow speed motor, with a free

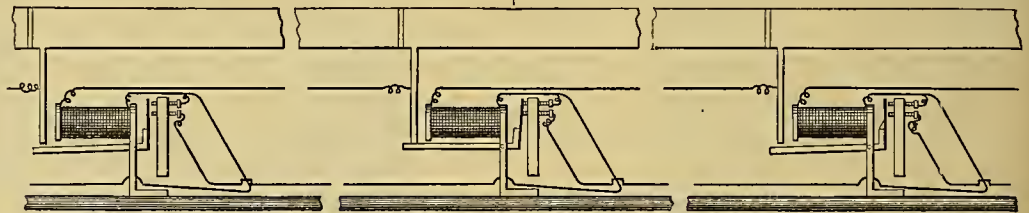

Fig. 1

running armature and direct gearing, without increasing the weight of the motor beyond a desirable point, or necessitating the employment of a special car for carrying it.

And here we come to the third division, the transmitting device for supplying the current from a central station to the moving car.

And here is the primary cause of all the trouble.

An ideal system would be the overhead wire freed from its objections, which are:

Danger to life and property.

number of these objections, but contain others which are hardly less important.

The main fault is, however, their lack of economy, caused by the roundabout way of applying the current, and the imperfect manner of storing it.

The fact that with a multitude of enthusiastic supporters, for a number of years, it has failed to make any important advances, or to be used on other than a small scale, speaks louder than any criticism for its inefficiency.

Even if the batteries could be made several times more efficient, it could never hope to compete with the direct method, especially one with improved insulation and carrying a high voltage, which could distribute over large areas with practically no loss or drop of potential, caused by the resistance of its conductors. It was to overcome some of the disadvantages above referred to, that I devised the conduit system which I will now describe.

My invention embraces as its principal features, a continuous main or supply conductor, insulated and protected in the tubular lower part of a casing, a cross section of which is shown in fig. 2; and a series of working conductor sections, insulated and supported in the top channel of the casing, with their upper surface exposed and adapted to come in contact with brushes on the car—and electro-magnetic contact-making devices, for bringing the conductor sections separately and successively into electric connection with the main insulated supply conductor. These contacts are arranged to be operated by a very small current, derived from the main conductor and extending through branch wires to the adjacent sections, thence through the forward brush to a rheostat on a car, and thence to ground

or a return conductor. Fig. 1 shows a working plan of the apparatus; the car itself is supplied with two brushes, at a distance apart, equal to the length of a section of the working conductor, which is laid centrally between the tracks.

The ends of the section are separated by insulated material, and the contact length of each collector is sufficient to overlap this insulation and momentarily receive current from two adjacent sections. As a matter of fact these collectors are intended, each to consist of a pair of small wheels running on the supply rail.

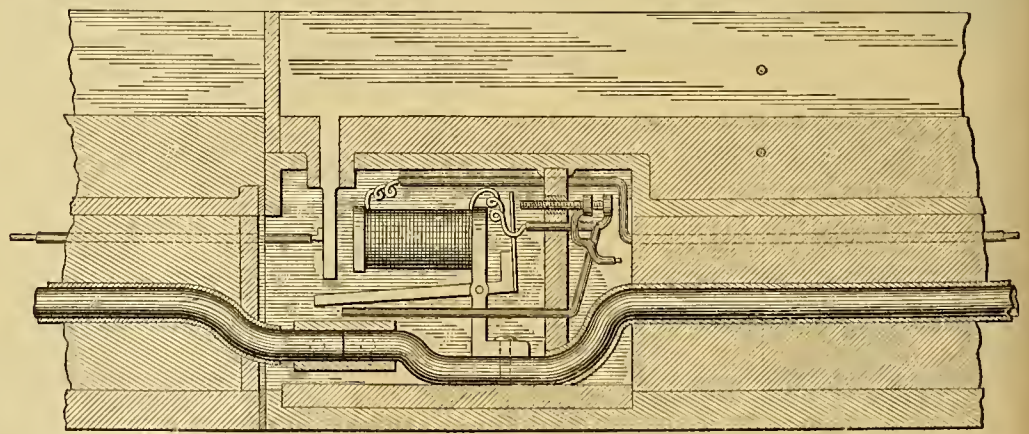

ST. RY. GAZETTE, CHI.

Fig. 3

The limitation of voltage made necessary by defective insulation at the expense of economy and distribution.

The liability of dynamos and motors being destroyed by lightning, which no lightning arrester can protect.

The inductive interference with telephones, which exist with all but double trolley systems; and lastly, the unsightliness and expensive maintenance of a system of overhead wires and guards.

Storage battery systems overcome a large num-

Closed at the start, a single one of the switches throws current into one of the sections on which the car rests, and thereafter, whether the car is moving or at rest, the operation of the parts is entirely automatic. Fig. 1 shows three sections of the track and three of the automatic switches. It will be seen that this switch consists of an electro magnet, furnished with an armature which serves to lead the current to a projection from the working conductor.

The opposite end is turned upward at right angles, and forms another switch of which the



purpose will be seen later. The terminals of each magnet, are connected respectively to the preceding and succeeding sections of the working conductor, to the former through the contact devices shown, and directly to the latter.

Suppose now the switch of the left hand section shown open, to be closed, and the rear collector of the car to be just leaving the section, while the forward collector is just passing from the central to the right hand section shown. Current now passes into the first section of the working conductor through the closed switch, and also through the double contacts connected together by the rear end of the magnet armature through the small connecting wire, to and through the magnet of the middle section, and thence to the car, through the forward part of the forward brush. Thus the magnet of the central section will be energized and its armature attracted closing the switch and letting the current pass from the supply conductor to the central section of the working conductor; but as soon as this switch is closed, the magnet of the first section is shunted around by the low resistance of the direct connection between the supply conductor and the central section of the working conductor.

Hence its armature falls, and falling breaks all connection with the first section and leaves it insulated.

As the car passes on this operation is successively repeated through the following sections.

The result of this arrangement is a continuous supply to the sections immediately under the car, the remainder of the working conductor being insulated, consequently there is but little tendency to leakage, and the insulation usually so difficult becomes comparatively simple. It will be readily understood, that neither moisture nor a conductor accidentally coming in contact with a section of the working conductor, and grounding it, would cause a short circuit, nor maintain one, after the car had passed; and this is an essential feature, possessed by no other system using a sectional rail method of supply.

The simplest form of electro magnetic contact device would be one, in which the magnets would be in series with the motor, but this would require magnets of a large size, wound with a coarse wire and would require a large amount of current to maintain the contact when the car was stopped, and would be liable to sparking and sticking at the contacts. By the arrangement of the magnets in multiple arc, I am enabled to use small magnets wound with fine wire, and to put the whole contact device in a junction box about 3x3x4 in., formed by an enlargement of the lower tube, see fig. 3. These devices are simple and

inexpensive, and may be wound with iron wire, and are adapted to be interchangeable. The whole conduit may be made complete in sections 4 to 6 feet long, and coupled together and put into position in center of the tracks, without disturbing the track rails already down; the conduit being only about 7 inches high.

It will be seen that the conduit is entirely closed the main wires imbedded in insulating material in the lower part, and the conductor sections in the upper flaring portion; thus avoiding all the mechanical and electrical difficulties of a slotted arrangement, which is apt to become filled with snow, ice, sleet, mud, etc.

The forward part of the car of my system is preferably supplied with a small revolving brush, which sweeps the top of the conduit, and keeps the conductor sections clean.

The absolute safety of this system cannot be questioned, as the only sections that can carry current are those immediately under the car, and protected by it.

The path for the return current is preferably through the iron casing and the track rails, thus forming a parallel return, which acts the same as

explained by him at the recent St. Ry. Convention in Buffalo.

The heater, as shown in Fig. 1, consists of a narrow strip, or ribbon, of asbestos enclosed in sheet iron, about 3" width and about 1/4 in. in thickness, which is intended to extend from one end of the car to the other, under the seats, on both sides, midway between the seat and the car flooring, and protected from the person or clothing of the passenger by a wire screen. It is enclosed on all sides except the face in a copper

radiator or reflector in order to divert the heat into the proper channel and to protect against loss. A second strip of iron of the same dimensions is attached to the first strip by a single row of small bolts extending from end to end, thus serving the purpose of a compressing plate and, at the same time, forming the other side of the heater. The resistance wires are imbedded in asbestos, and the compression plates are bound firmly together by means of the small bolts before mentioned, and are located between the two strips of iron. Three or more resistances of reflex or zigzag form are used which not only extend from end to end of the heater, but also, connected by proper wiring each resistance with its companion on the other heater on the opposite side of the car, so that a single resistance extends not only down one side of the car in both heaters, but also around the car on both sides; in other words, it is intended that from two to three resistances, each one in parallel and independent of the other, extending from end to end of the heater, but each one connected in series with that of a companion on the opposite side of the car, shall be used, in order that, when the circuit is closed upon one of them, a certain amount of it will flow, which of course, with the given number of volts, is inversely as the number of ohms and the heat resulting from the flow of the current through the resistance becomes equally distributed on both sides of the car from end to end, thus increasing the amount of heat evolved. Since two or more resistances are then in the circuit, so, if three resistances are cut in the circuit, the amount of heat will be increased again over that of the other two, and if these resistances have the same number of ohms under all conditions, there will be three times as much current consumed and consequently, three times as much heat evolved as when only one resistance alone is used in the circuit. This provision is made in order that the heater may be adopted to any kind of climatic or atmospheric conditions.

With regard to the amount of power required to generate the requisite amount of electricity for the development of the required temperature,

it is claimed that 9 amperes of current, equal to about 7 1/2 to 8 H. P., are used at first, but only for a few minutes, after which but 1 1/2 amperes are used.

The current is controlled by the motor-man.

Fig. 2 shows the heater as placed on the Pullman street car—a section of the seat having been removed in order to obtain a view of the

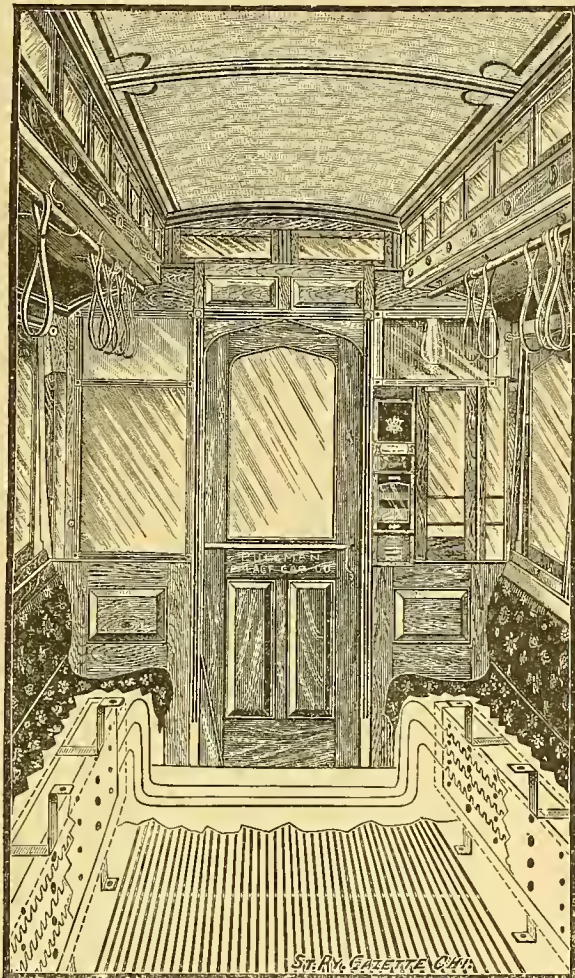

FIG. 2

a double trolley system, in avoiding inductive interference with telephones

And the placing of the main wire, under ground, is the only way that it can be effectually protected from lightning.

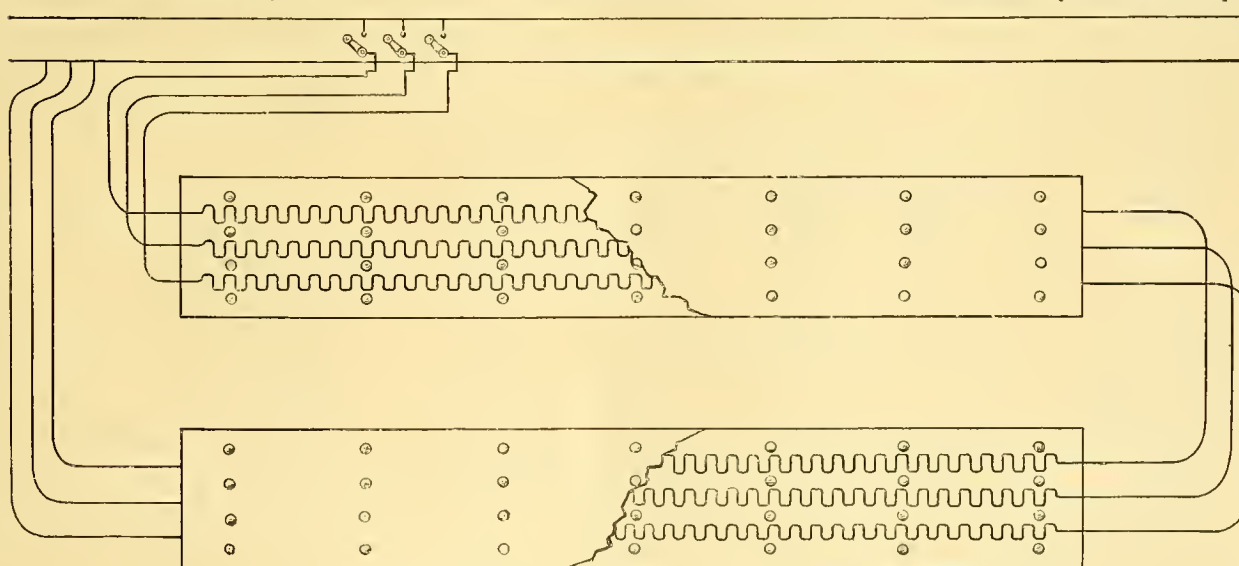

FIG. 1.

**Electric Car Heater.\***

The accompanying illustrations (Figs. 1 and 2) show a system of electric street car heating now being placed on the market by Mr. C. B. Hanna, its General Agent, and of which the superior points of merit over all others were fully

\* Carpenter Nevens Electro-Heating Co., Minneapolis, Minn.

heater in position.

The Electric Merchandise Co., of Chicago, has equipped about seventy-five roads with its rawhide pinions, the demand for which is still on the increase, and which are giving perfect satisfaction wherever they are used.



**City and South London Railway, London, England.**

The City and South London railway was recently finished and it is expected that in a few weeks the regular passenger traffic of the road will commence.

This railway is in a subway or tunnel, passing from King William street, London, under the Thames to Stockwell. The line has been constructed in the form of two circular iron tunnels 10 feet in diameter, driven

massive proportions. They run at 100 revolutions per minute, giving a piston speed of 450 feet per minute. They are fitted with automatic expansion gear of improved type on both the high and low pressure cylinders, and are controlled by a powerful governor, which is driven direct from the crank-shaft by cotton ropes, the automatic gear being so arranged as to cut off to three quarters of stroke. The engines will indicate up to 375 horse power each. The cylinders are steam jacketed, the high pressure is 17 inches diameter, and

96 per cent., and the measured efficiency of the engine and dynamo, *i.e.*, ratio of the electric power available outside the dynamo to the indicated horse power of the engine, is over 75 per cent.

Sir William Thomson's multicellular electrostatic voltmeters are used for measuring the electromotive force. The current from the dynamos is conveyed to a general distributing and testing switch-board, fixed in a recess of the engine house.

The site occupied is a plot of about two or three acres on the surface, or ground level, Fig. 1. The access between this depot and the subway is by a curved tunnel descending from above ground by a steep incline of 1 in 3½ feet. Up and down this the trains are brought or lowered by a rope and winding engine. This short bit of tunnel is remarkable. Formed on a horizontal radius of 250 feet and a severe vertical radius, it is marvelous that the junction of the two drivings, one from below and the other from above, should have met center for center and level for level within an inch or two. At the depot the carriage shed is large enough to contain six trains side by side. The platform at the Stockwell terminus is shown in Fig. 5.

The main cables for the road consist of a copper core of 61 | 14 B. W. G., insulated with Fowler-Waring patent insulating material, and lead-sheathed.

The working conductor is of channel steel, carried on glass insulators the joints being fished and also connected with copper strips. The steel employed is of very high conductivity, and has been rolled especially for the purpose. The working conductor is divided into sections for convenience of testing and carrying out repairs on the permanent way. The insulation obtained, it is stated, is extraordinarily high. When the full pressure of 500 volts is on the complete system of working and feeding conductors, the leakage current does not exceed one ampere, so that the total loss by leakage is less than one-horse power; this is a small fraction of 1

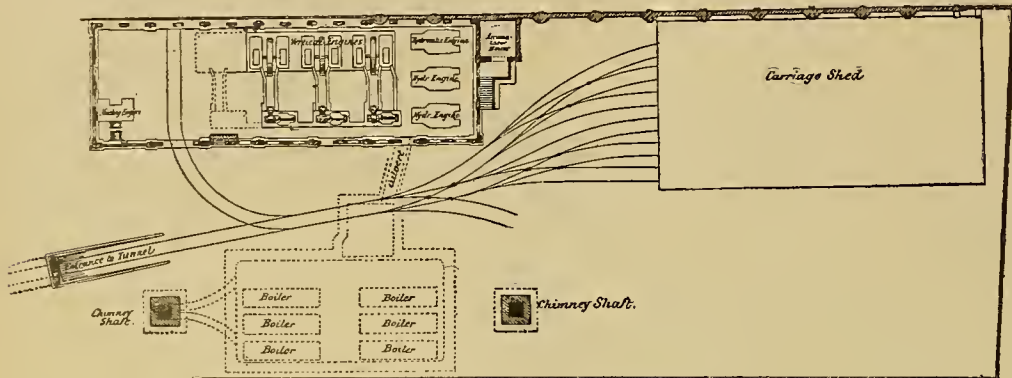

FIG. 1.—CITY AND SOUTH LONDON RAILWAY.

through the London clay and about 60 feet below the surface. The method of working resembles the sinking of a caisson. A steel shield was forced forward while material was excavated. When a sufficient advance had been made a ring of cast iron plates was built up, and a lime grout was forced into the space left by the sides of the shield between the lining plates and the soil. A speed of 16 feet per day was attained. Near the Stockwell terminus an old water course, consisting of gravel with a considerable quantity of water, was encountered. The air-lock principle for which this system is excellently adapted, was employed. The water flow was kept back for weeks upon weeks by the sheer force of volumes of compressed air. After some delay in providing the necessary machinery, which it was hoped might have been unnecessary, the tunnels were satisfactorily completed. These tunnels were made in 400 yards length, 200 yards being driven from other face, and meeting like lengths driven from faces. The extreme divergence of the junctions amounted in one instance only to seven eighths of an inch, and others not exceeding a quarter of an inch, although the datum levels had to be transferred from the bottom of the shafts, which now contain the lifts, to the centers of the lines of tunnel, as the shafts were all on one side or the other of the line of railway. The rate of excavation was often as much as 16 feet per day, the average of the working days being 13 feet 6 inches advance of heading. At the present time the rails of the road are laid, the platforms erected, and the neatly constructed underground stations, with their walls lined with white glazed tiles, are ready for passengers, and have a cleaner and brighter aspect than any of the other underground stations in London. Moreover, they will not be sullied with smoke and dirt from steam locomotives.

The scheme to work this railway by electricity, to avoid the use of steam and its noxious results, or the use of rope traction with slow speed and other disadvantages, was submitted to the City and South London Railway company, by Mather and Platt, engineers, Manchester, and the company accepted the idea. The whole electrical plant has been constructed under the special superintendence of Dr. Edward Hopkinson, who has acted throughout as consulting engineer, with G. A. Grindle as resident engineer.

The following description of a few of the details of the work, from the *London Electrical Review*, will be of interest.

the low pressure 27 inches. The valves are specially fitted with multiple ports, which reduces their movement considerably, and still gives a very prompt action. The flywheels are 14 feet diameter and 28 inches broad, and drive the dynamos direct by means of leather chain-belts 26 inches wide.

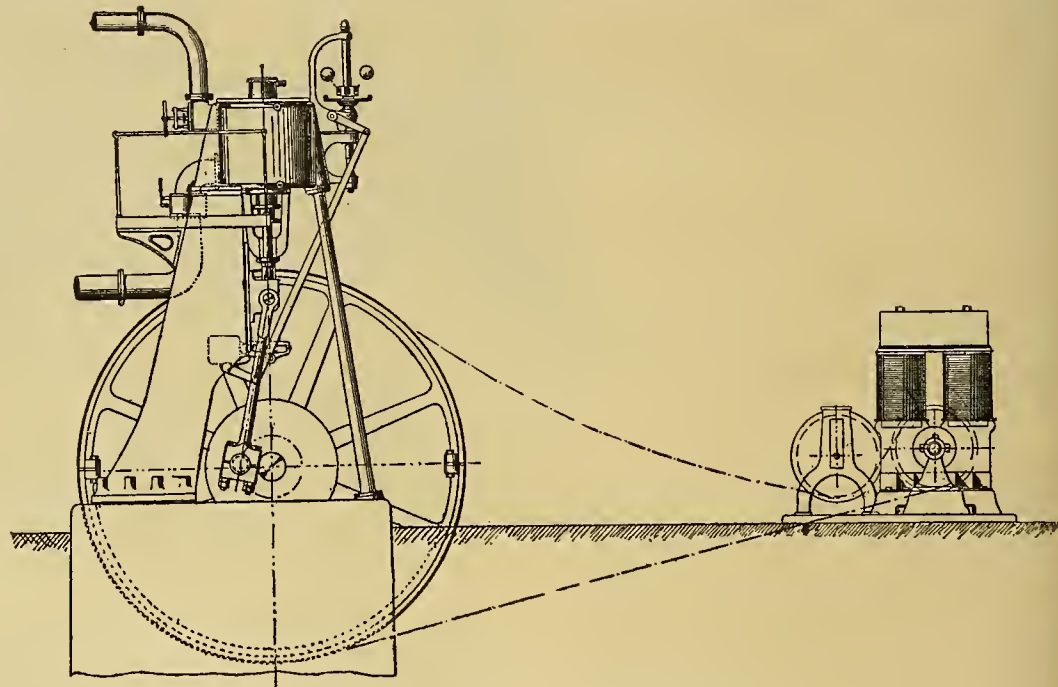

FIG. 4.—CITY AND SOUTH LONDON RAILWAY.

The engines are supplied with steam from six Lancashire boilers, 7 feet diameter by 28 feet long, which are fitted with mechanical stokers. Two large feed water heaters are also supplied, with brass tubes of ample surface, for receiving the whole of the exhaust steam from the engine without back pressure.

per cent. of the total power required for working the line to its full capacity. The current is collected from the working conductor by sliding shoes of iron or steel.

Fourteen ten ton electric locomotives, Figs. 6 and 7, have been supplied by Mather & Platt for working the line, each capable of developing 100 effective horse power, and of running up to 25 or 26 miles per hour. The armatures of the locomotives are constructed so that the shaft of the armature is the axle of the locomotive; in this way all intermediate gear and all reciprocating parts are entirely obviated. A motor is fitted on each axle, the axles not being coupled, but working quite independently. The current is conveyed from the collecting shoes through an ampere meter to a regulating switch, then to a reversing switch, thence to the magnets and back through the framework of the locomotive to the rails, so completing the electrical circuit. The locomotives are fitted with a Westinghouse automatic air brake and also a screw hand brake, and they are lighted from the working conductor. The train, when loaded, will weigh 30 tons, and it is intended that ten trains shall be worked on the line at one time. A train consists of an electric locomotive and three passenger carriages, 32 feet in length from end to end of the footboard. The long passenger carriages are pivoted on two 4-wheeled bogies, and the interior, which is divided by a door in the center, contains seats for 34 persons. The enclosed portion is 28 feet in length, the external overhang of the carriage platform being coupled up to the similar overhang of the adjoining carriage, and thus forming two open platforms between the three carriages. Upon each of these a guard travels with the train. These guards' platforms are protected at the sides by iron lattice sliding doors. The carriages are lighted by electric light, the current for the lamps being, in like manner, taken off from the conductor.

Each train carries its own reservoir of compressed air, sufficient for 40 stoppages, and as it arrives at the depot station of the line, recharges its air supply. The trains are also fitted with hand brakes, the stopping

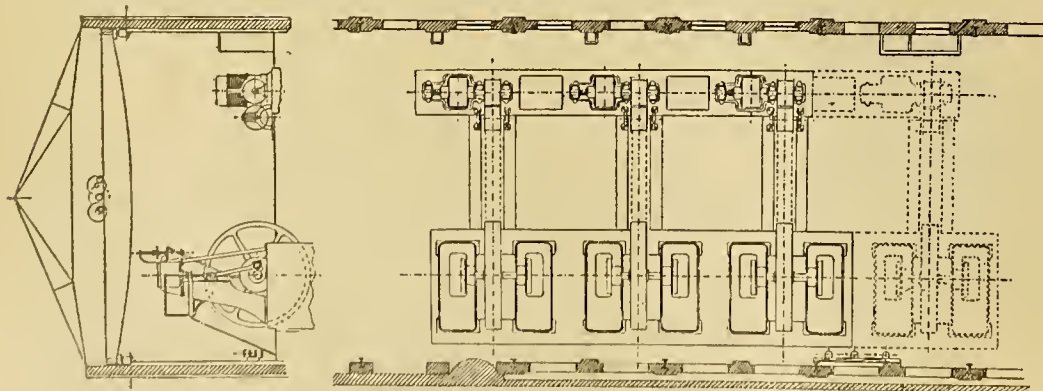

FIG. 2.—CITY AND SOUTH LONDON RAILWAY.

FIG. 3.

The whole of the machinery for generating the electrical current is situated at Stockwell, the suburban terminus of the line. At this point a complete plant has been erected for the generation of the electrical current. Figs. 1, 2 and 3 are plans and an elevation of the plant. Fig. 4 shows the general design of the engines and method of belting them to the generators. There are three large dynamos of the Edison-Hopkinson type, each worked independently by a vertical compound engine, designed and constructed by John Fowler & Co.

The engines work at a steam pressure of 140 pounds per square inch, and have been built of exceptionally

Edison Hopkinson dynamos are fitted with bar armatures. The weight of the armature alone is about 2 tons, and the weight of entire machine something over 17 tons. Each machine is capable of generating 450 volts and 450 amperes. The commutators are of hard copper insulated with mica. The magnet limbs are exceedingly massive, each limb, with its pole piece, being over 4 tons, and the yoke of the machine weighs about 3 tons.

The machine can be run as shunt, or compound only, as required. The total weight of copper wire on the magnet of each machine is nearly 1½ tons. The present machines have, it is claimed, an electrical efficiency of



power being thus completely independent of the motive power. Block signaling has been adopted. Should, by any failure of the engine at the depot, or any other cause, the train be brought to a standstill, passengers could leave the tunnel safely, as a passage two feet wide is provided clear of the rails, and at no point could the distance to be traversed exceed three-eighths of a mile.

In the generating house is the hydraulic machinery for supplying power to the lifts at the various stations. The cylinder of the ram is two feet in diameter, and the wrought iron flange-jointed pipes, which convey the water at a pressure of 1 200 pounds on the square inch are nearly a foot in external diameter. The engines which pump the water into them act automatically, being put in motion as the accumulator descends by loss of water at the lifts. At the end of this building is a locomotive repairing shop, with special appliances for lifting out or replacing the dynamos on the locomotives.

For the numbers of business men, clerks and employes coming daily into the city it will be a great boon to be conveyed at a speed of at least 12 miles an hour. The journey from Stockwell to King William street occupying 15 minutes, instead of three quarters of an hour as at present by omnibus. Ultimately the trains will follow each other at three minute intervals, but at the commencement of the traffic they will start about 7:30 a. m., and run every five minutes. The stations are lighted by gas; and for the water supply of the steam boilers, which is taken from the water company's mains, there are two large tanks, one of 12,000 and the other of 25,000 gallons, as a reserve.

**Electric Railways.\***

BY THEO. P. BAILEY.

The practical development of electric street railways, and their commercial perfection, may properly be said

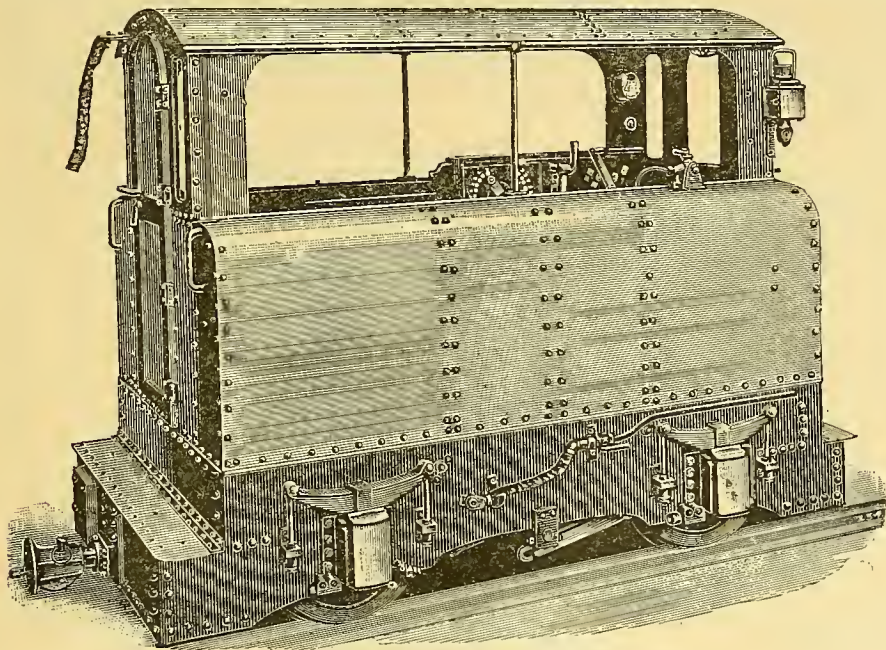

FIG. 6.—CITY AND SOUTH LONDON RAILWAY—LOCOMOTIVE.

to have been accomplished within two years, and yet there are at the present time 246 electrical street railway plants either in operation or ready to be put in operation within a short time. Two years ago, and even within the past twelve months, we were asked many questions by intending purchasers, which to-day are not even hinted at. Some of the prevailing questions of that age were:

- Can electricity be applied in our case?
- Can a street railway, equipped with electricity, be made a practical and commercial success?
- What will be the life of the apparatus?
- What will it cost to keep the apparatus in repair?
- Is not the current dangerous to human life?
- Will it not ruin the watches of passengers?

The street railway people to-day appear to have become thoroughly satisfied on these questions, and consider it an idle waste of time to discuss them further. But in lieu thereof they ask us this: "How soon can you furnish the equipment for our road, and what will it cost?" Just think of this statement for a moment: Two hundred and forty-six electrical railways in operation, embracing 2 024 miles of track, and 3,830 motor cars, requiring in the neighborhood of 6,400 motors with a probable aggregate capacity of 174,435 horse power, employing an electrical generating capacity at the station of about 94,880 horse power! Did any one of you anticipate two years ago that such a condition of facts could under any circumstances be realized within so short a time? I attribute this wonderful development and success to the following causes:

First, the full practicability of the undertaking; second, the wonderful earning capacity of the electrically equipped car as compared with the horse car; third, a determination on the part of the electrical manufacturers to meet the requirements of the railway companies; and fourth, the untiring and indefatigable efforts of the exploiter or salesman.

Among the numerous and possibly fatal objections

raised to the use of electricity, when it was proposed to apply it to street car propulsion, was that grades exceeding five per cent. could not be mounted. But experience and practice have shown that grades as high as fourteen per cent. can be ascended with reasonable safety and satisfaction. There is a grade of 13 2 10 per cent. at one point on the line of the street railway at Lynn, Mass., over which sixteen-foot cars, equipped with two 15-horse power motors, are in daily and successful operation. At Milwaukee a grade of 10 3 10 per cent., 430 feet long, is encountered and successfully operated over by twenty-foot cars, equipped with two 15-horse power motors, the total weight of car complete with passengers, being 10 1/2 tons. A similar grade is met with at Newport, R. I., and Omaha, Neb., and numerous grades almost as heavy are seen in the electric railway systems at Des Moines and Davenport, Ia., and Kansas City, Mo.

At the present time there are as nearly as can be ascertained 957 street railways in the United States and Canada. Of this number 589 are operated by horses; 49 by cable; 246 by electricity; 73 by steam.

It is estimated that the total money value of these combined properties is \$164,400,000, proportioned as follows: Horse railways, \$58,900,000; cable railways, \$49,000,000; electric railways, \$49,200,000; steam railways, \$7,300,000.

These figures are at best only approximations, as it has been found impossible to secure absolutely accurate information.

This combination of motive powers is doing service over or upon 8,818 miles of track as follows: Horses, 5,713; cable, 527; electric, 2,024; steam, 554.

I find that the cost per car-mile for the several methods referred to, including all operating expenses and fixed charges, other than interest, is as follows: Horses, 5.7 cents; cable, 2 1/2 cents; electric, 2.2 cents; steam, 5 cents.

Assuming that the railway company has secured the desired franchises and rights of way, has laid out its lines of track so as to avoid all excessive grades, and yet reach the attractive and important points of the town or city, and that it has been fortunate enough to make proper selection of its apparatus, the next important work for it to determine is the location and arrangement of its power station. The selection of a site

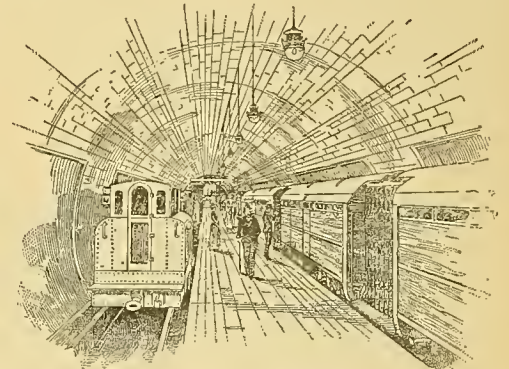

FIG. 5.—CITY AND SOUTH LONDON RAILWAY.

should be made with reference to obtaining the best facility for handling coal and securing water, and also with reference to the electrical center of the railway system, in order to realize the highest degree of economy in the operation of the plant. The arrangement of the power station is equally as important as its location, with regard to handling the work with the least cost for labor. The selection of the steam plant is a matter of great importance, and should be left with a thoroughly competent and reliable engineer to determine what particular type of engine, boiler, etc., should be used; and the matter should be left under his direction and care until the installation has been completed. It is manifest that in so doing serious blunders will be avoided. I do not think it can be justly claimed that the railway companies have been too liberal in the amount of horse power purchased for the operation of their generators. In order to secure the best results, with reference to reliability of service, the horse power of the engine should be at least 20 per cent. greater than that of the generator which it drives, in order to provide for loss in transmission and excessive loads which are thrown on the generator by reason of a large number of cars starting at the same time, or on account of a ground being accidentally thrown upon the line. The steam plant should be so arranged and connected with the generators that either engine or generator may be readily interchanged; and the arrangement of the engines and generators should be made with reference to future extensions. The switchboard, containing the indicating and regulating devices, should be located so as to be most accessible to the attendant.

Both the power and electrical plant when complete and ready for operation, should be placed in the hands of men of experience and learning in these departments, in order to insure reliability of service and the greatest economy in operation and maintenance. I would rather provide in advance for the expenditure of \$1,000 or more in this department than to run any risk of having to pay out four times that amount in repairs and losses occasioned by mistakes of incompetent men.

The location and arrangement of the car house is a question of considerable importance, and open to serious mistakes growing out of bad location or improper interior arrangement. Some advantages are secured by locating the car house immediately adjacent to the power station. In this case it may be heated with the exhaust steam from the power plant, and the services of employes utilized in both buildings, and repairs to apparatus concentrated at one point. The car house should be provided with suitable pits for the inspection of the motors and also have proper accommodations for cleaning the car bodies. If the car house is to accommodate more than twenty or twenty-five cars, it should

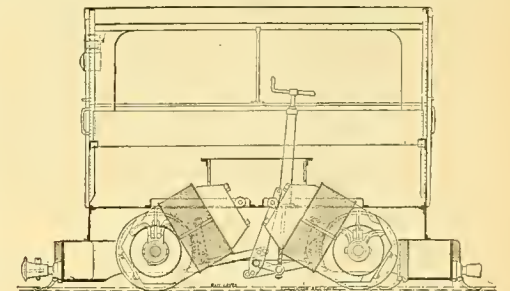

FIG. 7.—CITY AND SOUTH LONDON RAILWAY.

be provided with running and turning tables, and should also have more than one exit.

I cannot pass from the question of inspection of apparatus without emphasizing the extraordinary importance of having this work done thoroughly by competent and faithful attendants. With electrical apparatus of standard makes we can reasonably expect that a motor car sent out in the morning for the work of the day, having passed through proper inspection, will perform its duty with a degree of certainty that need leave but little, if any, cause for anxiety. This feature is perhaps the most difficult one to impress upon the management of electrical railway companies, more especially where such railways have been converted

A large majority of the street cars equipped electrically at the present time are mounted upon a single truck, to which are attached one or two motors, as required by the conditions existing in each particular case. The lightest equipment with which I have had to do has been a single 15-horse power motor upon one truck; and the heaviest equipment has been two 15-horse power motors upon one truck. The tendency, however, at the present time, seems to be in the direction of longer cars, double trucks, and heavier motors. This action is prompted very largely, no doubt, by the sad and costly experience of some companies where trailers were used in connection with the motor car; serious accidents, and in some cases death, having resulted from injuries sustained by passengers in falling between the motor and the trailer car while passing from one to the other.

The use of the longer car with double truck is recommended further as a means of comfort to the passengers, and also on account of the longer life of the car and its equipments. This style of car is, of course, unattended by the oscillating motion found in the shorter car with a single truck. Where the shorter motor car is used with a trailer experience shows that there is a great loss in wear and tear by reason of the cars jangling together when the brakes are applied. This fault is obviated in the longer car, and while its seating capacity may not be equal to that of two shorter cars, it is approximately so. It is claimed further for the longer car with double trucks that less energy is required to operate it; also that it saves the expense of one man, decreases the expense of maintenance, and increases the facility for handling passengers.

In treating of the subject of electric railways from a commercial standpoint, I have considered only that branch designated as the single wire overhead system.

For obvious reasons too much care cannot be observed in planning and locating the various factors which go to make up a complete electric railway plant.

\* Read before the Chicago Electric Club, November 17, 1890.



from animal power. If railway companies will guarantee that degree of care and watchfulness in the operation of their motors indicated above we take practically no chances by giving them the broadest guarantees as to the durability of the apparatus, and the cost of maintenance and repair.

It is apparent that in the overhead construction the highest degree of care should be exercised as to its details and arrangement, for this part of the equipment is constantly open to criticism. We cannot blind our eyes to the fact that serious, and in some instances fatal, criticism has been made to this work. We must all avail ourselves of the experience which has attended our efforts and see to it that our overhead construction is not in any case, or for any reason slighted.

I think an iron pole 28 or 30 feet long, made in three sections of extra strong pipe six inches in diameter at the base, and four inches at the top, provided with wheel base and insulated cap, presents the most slightly appearance on the street and forms the most substantial construction that can be had. Next in reliability and appearance is an octagonal pole of southern pine suitably painted; and lastly, and the pole most commonly used, the Western Union standard. These poles should be properly set with sufficient rake to allow of sustaining a strain of at least nine hundred pounds. To these poles should be attached, by means of eye bolts, a galvanized steel wire having a diameter of at least .204 of an inch and drawn taut, so that the poles will come to a perpendicular position. To these span wires there should be attached a suitable insulating device over the center of each track with proper attachments for suspending the trolley wire. This insulating device should be small in its construction, consistent with strength and high insulation, and the insulating material formed in such manner that it will in itself constitute a protection against moisture. The trolley wire should in my judgment be at least 3/8 of an inch in diameter, considering the objection that is raised to the multiplication of wires in the streets. This wire should be hard drawn copper in lengths of at least one mile each. In this case the number of splices is reduced to a minimum, and by means of a suitable splicing ear, the joints can be neatly, perfectly and securely made.

Where the streets are of a width of at least sixty feet from curb to curb, it is regarded as thoroughly safe and practicable in cases of double track roads to place the poles in the center of the street between the tracks, and whether these poles be made of iron or wood of octagonal shape, I consider that this arrangement presents the best form of overhead construction that can be secured.

When a conduit can be constructed that will permit of the safe, reliable and economical operation of street railways by means of electricity, we will all rejoice, and be glad. If its first cost can be made sufficiently reasonable to permit of its use in cities of, say 50,000 inhabitants, it will be a magnificent achievement, and one that will surely bring its just reward to the successful inventor.

This thought is not prompted by reason of any vexatious troubles or annoyances which have occurred in the operation of the overhead system, but wholly on account of the objections which have been raised to the rapid multiplication of poles and wires in the streets, occasioned by the remarkable development and progress of the electrical science.

One of the prominent electrical companies is, and has been for some time, carrying on extensive and elaborate experiments with conduits, but have not, I believe, fully satisfied themselves of the commercial success of their latest undertaking.

I find little or no objection to overhead wires in places of less than 50,000 inhabitants. For this reason, and the fact of its low first cost, the overhead system will, no doubt, continue to be used in such places for some time to come, regardless of developments in the conduit system.

One of the most important features of an electric railway system is the track or road bed. My experience has been that sufficient attention has not been given to that part of the equipment, especially until very recently. The track should be constructed of a good form of girder or "T" rail, weighing 54 or 40 pounds per yard respectively, and should be attached securely to suitable ties placed not more than 2 1/2 feet apart. It should be well ballasted, and where crossings are made over other tracks solid castings should be used in order to prevent the jolting and jarring which occurs when passing over them. The rails should be kept as clean as possible where they are used as a part of the return circuit. In order to use the rails of the track in completing the return circuit they should be firmly connected together by a copper wire in addition to the ordinary fish plates, and in certain cases, depending wholly upon the length of the line, number and extent of grades, and number of cars and amount of traffic, there should be used a supplementary copper wire, the size of which must depend upon the conditions just named. It is asserted by some electricians that the efficiency of the return circuit is increased in all cases by the use of a supplementary wire; but my experience has been upon small roads where the grades and traffic are light, that satisfactory and economical operation is secured where the supplementary wire is omitted.

Some of the essential requisites of an electric motor car are, proper controlling mechanism and reversing switch for controlling the speed and direction of the car, a lightning arrester and multiple fuse box. It should also be provided with suitable life guards, bells, and head-lights. The wheels of the car should, in my judgment, be at least 33 inches in diameter and weigh 305 pounds each. This will give increased adhesion and allow the motors to be raised sufficiently high from

the ground to prevent practically the possibility of its being injured by striking obstacles between the rails.

Increased speed with a very slight increase of power will result by the use of the 33-inch instead of the 30-inch wheel.

The possible speed of a car equipped electrically is measured only by the limit of safety. The regulation speed in the majority of places is twelve miles per hour, and the average mileage per car per day about 115. It is well known that upon well regulated steam railroads the locomotives rarely make a continuous run of over 100 miles per day; and considering the extraordinary care that is given to them, and remembering in the same connection the very slight degree of care given to the average electric street railway motor, I think the latter is entitled to a very handsome compliment for the good service it gives us; and when you know that the best average mileage that can be made by a car propelled by the Kentucky horse or Texas mule is sixty miles per day, and even in doing this it is necessary to make at least four changes per day, I think you will admit that the electric railway motor is doing most admirable service.

The smallest town in the United States which has an electric street railway in operation is Southington, Conn., with a population of 5,400. Two cars are in service over two miles of track, and the average daily receipts are \$9.00 per car. The power for the operation of this road is furnished by the local lighting company, and costs \$1.25 per car per day. The largest electric railway is at Boston, Mass. The entire system comprises 284 miles of track, sixty of which are electrically equipped, and there are 312 motor cars in operation. During the month of August they had 300 motor cars in service, making a total mileage of 384,700,000. The mileage of the tow cars was 59,948,000, making a total car mileage of 444,648,000. From August 10th to August 16th, 700,000 passengers were carried by these cars without a single delay. In the month of September 312 motor cars were in operation, making a mileage of 343,466,000, and the mileage of tow cars 56,047,000, making a total car mileage of 399,513,000.

Average number of motor cars run per day	20
Average number of trail cars run per day	0
Average number of hours per car in service per day	18
Average number of miles per car per day	108
Electric motive force	500
Average ampere readings taken hourly	122
Average electrical horse power	81.8
Average electrical horse power per car	4.9
Number of passengers carried per day	11,060
Number of passengers carried per car per day	553
Cost of operating, per car mile	\$ .0616
Receipts, per car mile	.2560
Cost of operating, per car per day	6.65
Receipts, per car per day	27.65

Most flattering testimonials have been received from railway companies who have adopted the electric system and while they express their absolute satisfaction with the new motive power they also state that the earning capacity of their road has been materially increased. In some cases the increase is given as high as 400 per cent., and in others as low as 50 per cent., but in no case that I can now remember, has the increase been given lower than the amount last stated.

Inquiry is sometimes made as to whether a motor car can be safely and reliably operated without a conductor. The present form of trolley and overhead construction readily permits of this; but I do not regard it as practicable or advisable except in the smaller places where the business of the road will not justify the expense of a conductor. I am familiar, however, with a number of roads in towns or cities having a population of less than 30,000 where the car is in the exclusive charge of the motorer, and no trouble is experienced in its operation. With a good track there is little, if any, possibility of accident when proper care is exercised in taking curves and switches. Where the business will warrant the expense, however, there should be a conductor with every car or train.

We cannot overlook the fact that there are still some complaints of excessive cost for repairs and maintenance of the electrical apparatus, but I insist that the responsibility for this condition does not rest altogether with its manufacturers. The managers of these electric roads must appreciate that they are exacting a greater mileage duty of their motors than is expected of the ordinary railroad steam engine, and under conditions manifestly more unfavorable. If they will admit this, and see to it that their tracks are put in good order and so maintained, and the same degree of care and attention given to their motors that is given to the steam engine, I am satisfied they will have little to complain of. How rarely do you find an electric motor operated on a track like that prepared for the steam engine? And how seldom do you find a man in charge of the motor car who has the intelligence, training and experience of the steam engineer?

Several railway companies which adopted the cable system before the possibilities of the electric system were fully appreciated or understood, are now seriously considering the complete displacement of that system and the substitution of electricity in its stead. I was recently informed by the president of one of the electric railway companies, whose line is a competitor to a cable road, that the latter company, feeling keenly the effect of the competition of the electric system, had about concluded to reduce the fare on their road to 4 cents per passenger. Before this action takes place, however, I have no doubt that some bright representative of the electric system will persuade our cable friend to join the procession of progress, abandon the cable, welcome and adopt electricity as the motive power, and thus

preserve the independence and stability of his street railway system.

There is no system or method of rapid street transportation that is so universally popular as the electric system; its wonderful flexibility is unparalleled in the history of street railways; capable of moving in either direction with equal facility, its value is materially enhanced from the standpoint of safety. Its first cost is about the same as for the animal system, and considerably less than the cable system. Knowing what the possibilities of the electric system are, and how cheaply it can be maintained and operated under proper conditions, I think we will see street railways thus equipped in many towns of a population not exceeding 10,000, and in some cases even less, and at a period not very remote.

I have previously alluded to the remarkable growth of the electric railway business, and given some reasons for it, but I do not feel that full justice has been done to the pioneers—I mean the manufacturers of the apparatus. When you consider what they had to do, and what they did do, in order to inspire confidence in the undertaking, I think you will all agree with me that they have merited even greater success than has attended their efforts, if that be possible. Contracts with all sorts of guarantees were made, long trial periods were given, the cost of maintenance guaranteed to be less than for the same number of cars operated by animal power, the current guaranteed not to be fatal to human life, and the system warranted to work in a thoroughly practical and successful manner, with a general and sweeping provision that in case of failure in any of the guarantees the railway company could, at their option, throw the apparatus out, and assess the electrical company any damages which they had sustained by reason of the alleged experiment. Was there ever a new industry vouched for so absolutely by its projectors? Had the electric companies been less liberal with their guarantees, and not exhibited such a marked degree of confidence themselves, we undoubtedly would have been able to day to count the number of electric railways by tens instead of by hundreds, for it is but a short time since the financial world has given its unqualified indorsement to the system. Bankers and trust companies took no part in formulating public sentiment or confidence in this matter. The undivided burden was assumed and borne by the electrical company, and not until they had fulfilled their numerous guarantees faithfully and well, and demonstrated beyond all peradventure the full and complete success of the electric street railway, was the moneyed man or corporation willing to assume any hazard or risk. How the conditions have changed in two short years! Every principal city in the United States now has its electric street railway, full confidence has been established, and unreasonable guarantees are no longer required.

In closing, permit me to offer this prediction, that within a few years surface and elevated railways operated by animal, cable or steam power, will be numbered with the events of the past, and electricity, with all its beautiful attributes, in all its grandeur and magnificence, and in the full measure of the wide range of its possibility, will claim supremacy in the broad realm of street railway transportation.

Corrugated Steel Fastener.\*

This device, which was exhibited at the Buffalo Convention, is made of sheet steel, to which is imparted, by means of special machinery, a sharp penetrating edge, adapted to be readily driven into soft or hard wood, irrespective of the direction of the grain, and when so driven, its abrupt corrugations interlock with the wood and hold it firmly together, thus preventing splitting, checking or warping.

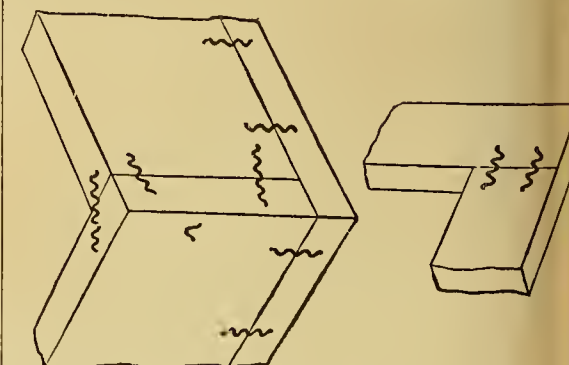

The fastening device is designed to take the place of dowels, and dispense with tenons and mortises, as it is claimed that it makes a stronger, better joint, with much less expense than by the ordinary manner.

The thin sheet of steel may appear insufficient, but when sharpened, corrugated and driven as shown, it attains great strength, which is increased still more by its interlocking with the fibre of the wood. Car builders can readily see these points.

\*Pratt & Letchworth, Buffalo, New York.



**Belleville Cable Road at Paris, France.**

The first cable road in Paris, France, is the Belleville street, which extends from the Place de la Republique to the cathedral at Belleville. The construction work has been completed for some little time, but the company which operates the road has been compelled to wait for the completion of the cable. The French papers admit that Paris has been rather behind the times as far as the adoption of the cable system is concerned; but they assert that on its equipment the very latest ideas in cable construction have been embodied. If one may judge from the accompanying cuts, no features radically departing

an extra cable to be used in case of serious damage to that running on the line. According to the calculations of the engineers of the line, one cable a year will be required.

The Belleville road is a single track cable line with double tracks only at turn-outs. As Fig. 2 shows, the rails rest upon iron yokes which are placed at a distance of about three feet apart. The cable is grasped as shown in Fig. 2, by wooden shoes. Five cable cars will run on the line, but it is probable that these will draw travellers. It is estimated that the cars will carry about 33,000 persons daily. The schedule of fares is so arranged that persons going to and

Chicago Tribune—Frank Bauerlin.

The run out of 3¼ miles was made in 17 minutes, and the return trip in 13 minutes. The exhibition was highly satisfactory. On Sunday five trips in all were made, the car running about 40 miles and carrying about 700 passengers. It also hauled a trailer which carried 140 passengers.

Mr. Hood is particularly anxious for street railway men to witness the operation of the car, and will extend every facility to those desiring to investigate the system.

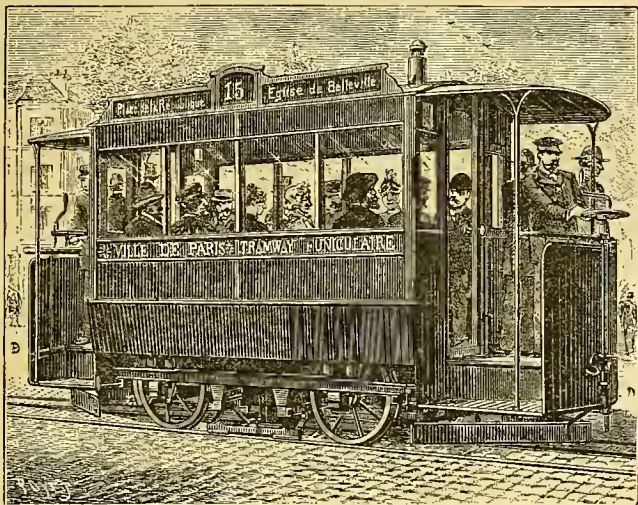

FIG. 1.

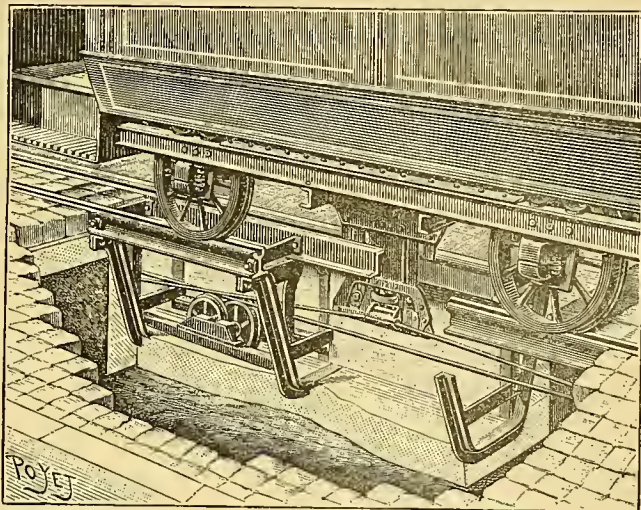

FIG. 2.

from the American practice have been adopted. The regular operation of the road will be commenced during the present month. The general appearance of the cars is shown in Fig. 1.

In Fig. 2 are represented the essential features of the system, showing the cable, the grip and the general construction. The power house is located near the terminus of the road at Belleville. Two engines of the Corliss type furnish the motive power. The arrangement of pulley wheels at the station is shown in Fig. 3. The direction of the cable is indicated by the arrows.

After leaving the main pulley in the center, the cable passes over the pulley at the right, which is so inclined that the cable then may pass to the tension pulley at the left. This last, it

from Paris at certain hours of the day are carried at half price. This is a concession to the demands of the Parisian workingmen. *La Nature*, from which the cuts are reproduced, expresses the hope that many cable lines will soon be constructed in Paris to satisfy the increasing demand for rapid transit.

**Storage Batteries in Chicago.**

An exhibition of the working of the "Edco Car," which was shown at the Buffalo Convention, was given in Chicago on Saturday, the 22nd inst. in the presence of the following named gentlemen:

F. L. Theedy, general manager; John Miller, master mechanic; J. M. Roach, superintendent;

**From the Argentine.**

BY F. W. N. LODIA

During the last half year (according to the City Statistics) there was carried by the tramways of this city, no less than 14,311,933 passengers. This fact alone shows what the dividends must be to the lucky shareholders. The expenses are less here for the companies than in New York, London or Paris, because horses do not fetch that price here that they do in the three former cities, while it only costs the company from twenty to thirty cents a day (!) to keep a horse here in "going order" and where could you keep man's "best friend" for that price?

At La Plata (capital of Buenos Aires) there has been recently opened a steam tramway,

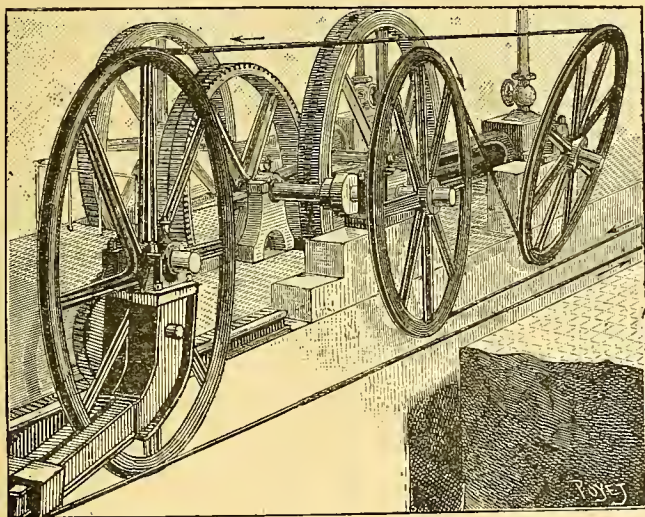

FIG. 3.

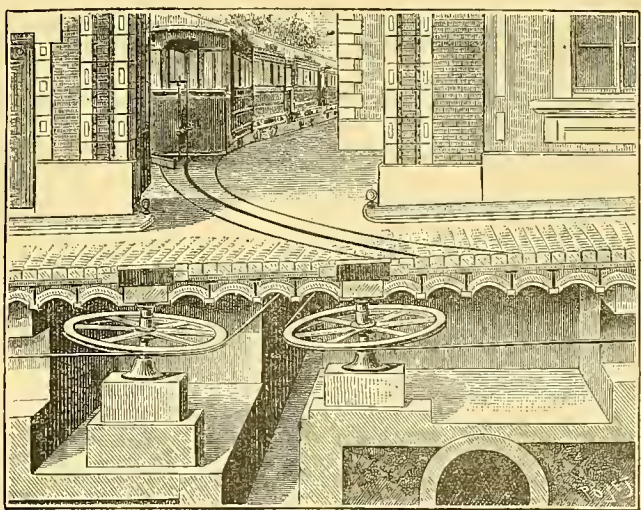

FIG. 4.

will be noticed, is attached to two arms of a lever which is about 13 feet in length. At its end is a weight of about 1300 pounds. On each arm of the lever is a toothed wheel which works in a rack. Only one of the wheels and one of the racks are shown in the cut. The tension pulley yielding to the strain and taking up the slack equalizes the stress on the pulley.

In Fig. 4 is shown the foundation under the station where the cable leaves and enters.

The cable is steel. It has a core of hemp, about which are wrapped six strands, each composed of twelve large and fourteen small wires. There is to be kept at the station at Belleville

L. L. F. Zeigler, all of the North Chicago Street Railway company; Mr. Pfoscher and Wm. Hood of the Accumulator Co.; O. H. Sheefe, C. D. Etnyre and S. B. Wadsworth, of Council Bluffs; C. B. Hanna, of Minneapolis; Wm. Mattison, and the representatives of the press, as follows:

STREET RAILWAY GAZETTE.—S. L. K. Monroe and E. V. Cavell  
Western Electrician.—John B. O'Hara.  
Electrical Review.—D. B. Dean.  
Electrical Engineer.—W. F. Collins.  
Electric Age.—F. M. Ireland  
Chicago Herald—L. E. Torrey.

which is the first of its kind in the Argentine Republic. The "enterprise" belongs to a syndicate and is represented by Senor Usugnon. Thinking it might have something to do with Thomson-Houston Electric Co., of Boston and Chicago (who have representatives in this city, also La Plata and Rosario) your correspondent took the opportunity of writing to their appointed agent in this town, asking him to kindly supply me with particulars upon the one lately opened in La Plata, but no reply has come yet, so am not in a position to give your readers the desired notices upon this newly started steam tramway.

(To be Continued..)



# The Street Railway Gazette.

S. L. K. MONROE, - - - - - MANAGER.  
E. V. CAVELL, - - - - - EDITOR.  
EDWARD J. LAWLESS, - - - - - ASSOCIATE EDITOR.  
W. L. S. BAYLEY, - - - - - MECHANICAL EXPERT.

## GENERAL OFFICES:

### CHICAGO:

8 LAKESIDE BUILDING.

AGENCIES } San Francisco, - - - 1222 Bush Street.  
} Toronto (Canada), - - - 53 Magill Street.  
Cable Address=TRAM. CHICAGO.

### Annual Subscription (Including Postage). Per Copy

United States, Canada.....	\$2.00.	25c.
Great Britain, Ireland, India, Australia 10s.	.....	1s.
Germany.....	9mk. 75 pf.	89pf.
France, Belgium, Switzerland.....	2fr. 95c.	Fr 1.10.
Spain.....	2ps. 95c.	Ps 1.10.
Austria, Holland.....	6fl. 74c.	55c.
Italy.....	12 lire.	1½ lira.
Venezuela.....	12 bolivars.	1½ bol.
Mexico.....	\$3.00.	30c.

Annual Subscriptions in Argentine Republic, 2½ peso; Brazil, milreis; Turkey, 54 piasters.

[Entered at the Chicago post-office as second-class matter.]

\* \* \*

Matter for publication should reach the Chicago Office not later than the last day of each month. All communications should be addressed, THE STREET RAILWAY GAZETTE, Chicago, Ill.

## Acknowledgment.

THE GAZETTE desires to convey to the Chicago delegation to the ninth annual convention of the Ohio State Tramway Association, at Columbus, its hearty thanks for the many expressions of appreciation of the efforts made by its publishers to make the trip to Columbus and back one to be always remembered with pleasant feelings, and to assure the gentlemen who comprised the delegation that such a result could not have been accomplished if it had not been for their unvarying good nature and hearty cooperation.

## Supply Men to the Rescue.

The fact that the several representatives of supply houses in attendance at the ninth annual convention of the Ohio State Tramway Association added to an immense extent to the interest taken in the proceedings is confirmatory evidence that the GAZETTE has never been wrong in its assertion, that the presence of these gentlemen at conventions redounds, in every way, to the benefit of the Association holding the meetings.

From time to time there has been considerable talk regarding shutting out supply men from conventions and the accompanying banquets, but, in almost every case, where the question has been put to the test of a ballot—it has been decided that the presence of these gentlemen could not be too earnestly desired. The interests of street railway officials and what are termed "supply men," are, to a great extent, identical—both are catering, either directly or indirectly, to the comfort of the public—both are mighty hunters—hunters of the mighty dollar—each one is absolutely dependent upon the other—"No cars, no rail—no road"—"No road—no cars, no rail."—Outside of conventions the question of the value of the supply men is never raised—why then should it ever be mooted?

We believe it to be no idle boast for us to affirm that the tremendous growth of the electric

industry—as applied to the construction and equipment of so many street electric railways within the four or five years last past—has been mainly due to the untiring energy of the big electrical supply houses, and the enterprise and nerve exhibited by them in taking, as pay for their work, *stock and bonds of the companies whose lines they equipped.*

This, if nothing else, should at once convince everyone that the supply man is not a necessary evil, but an absolute necessity, and we venture the hope that the small band of "kickers" against the attendance of supply men at conventions will hold a convention of their own in the historic caves of Adullam.

## The Tides as Generators of Energy.

Much has been said in favor of the plan of the French engineer who purposes to use old Ocean's ebb and flow, at and near Havre, France, for generating electrical energy, to be transmitted to Paris for general electrical purposes.

It is not doubted that the requisite power is there and that the engineer will harness it to do his bidding.

And yet the truth forces us to write again that there is nothing new under the sun except in the methods by which a well known force is to obey the behests of man.

For the last one hundred years, at least, the tidal power has been utilized all along the eastern coast of our country (especially where the rise and fall has been found to be considerable), for general manufacturing purposes. Notably grist mills, saw mills and factories. It will be noticed that the proprietors of these establishments arrange to take advantage of the enforced hours of idleness—four in number out of the twenty-four, when the tide is high or when the tide is low—for repairs, oilings and meals.

Not alone are the tides harvested, but the storm waves are employed as energies, to sound the danger whistles, which by their makers are made to give the alarms in as many octaves as there are signal stations, so that the storm-tossed mariner may, in the darkness, accurately judge of the location of his vessel and stand off or on at will.

There are, also, on the coast, many brilliant lights, whose power is the direct result of the scientific employment of the oldest, the newest, and most powerful of nature's force—electricity.

## Consolidation of Parallel Lines.

We publish in our legal department this month a very important decision bearing upon the consolidation of street railway lines. It is held in this case that in as much as each street railway is peculiarly dependent upon the traffic naturally incident to the street on which it is located, there can be no competition between parallel lines which can be of benefit to the public, and that therefore there can be no infraction of public policy in the consolidation of such lines. As a matter of both law and common sense this seems to be a sound position, but the court might well go further. Inasmuch as railway companies can give the public the best service when their affairs are most prosperous, in view of the fact that two parallel lines can be more economically managed by one company than two, it follows that under one management the public could be better served. Sometimes rare bits of common sense find their way into the pronouncements of law.

## LEGAL DECISIONS.

### COURTS OF LAST APPEAL.

CONSOLIDATION OF STREET RAILWAY LINES.—Appeal of Montgomery, Supreme Court of Pennsylvania, Oct. 6, 1890, 20 At. Rep. 399.

This is the appeal from a decision refusing to restrain the consolidation of two parallel street railway lines, it being held that the provision of the constitution of the state of Pennsylvania prohibiting the consolidation of parallel and competing railway lines applies only to steam and not to street railroads. The court says: "It is undoubtedly true, as we have several times decided, that the words 'railroad' and 'railway' are synonymous, and in all ordinary circumstances they are to be treated as without distinction of meaning. When either one or the other of these words is used in a statute, and the context requires that a particular kind of road is intended, that kind of road will be held to be the subject of the statutory provision; but if the context contains no such indication, and either of the words is used in describing the subject matter, the statute will be held applicable to every species of road which is embraced in the general sense of the word used. No necessary inference is therefore to be drawn from the mere use of either word that a limited class of roads was intended. It follows that we must search the context of the seventeenth article of the constitution in order to ascertain in what sense the word 'railroad' was used in the fourth section. It is the contention of the appellant that the prohibition of the section against the amalgamation of competing roads applies to street passenger railroad companies as well as to those of steam roads; and, if this contention is unsound, the appellant has no case. The title of the article is 'Railroads and Canals.' This is, of course, sufficiently comprehensive to embrace all classes of railroads or railways, and we accordingly find that a number of the sections are applied to steam railroad companies exclusively, and at least one section, the ninth, is applied exclusively to street passenger railway companies. The first section provides that all railroads and canals shall be public highways; that any association organized for the purpose shall have the right to construct a railroad between any points within the state, and to connect at the state line with railroads of other states; and that every railroad company shall have the right to intersect, connect with, or cross any other railroad, and shall receive and transport, each, the other's passengers, tonnage and cars, without delay. It must be conceded, at once, that this section cannot possibly apply to street passenger railway companies, as all its provisions are utterly hostile to such a thought. Section third provided that all individuals, associations and corporations shall have equal right to have persons and property transported over railroads and canals, and no unreasonable discrimination shall be made in charges for, or in facilities for, transportation of freight or passengers within this state, or crossing from, or going to, any other state. It is equally certain that this section, also, cannot embrace passenger railway companies, since such companies are, as a rule, though not always, without authority to carry freight, and do not extend to state lines. The fifth section is, also, inapplicable to street railroad companies, because it imposes disabilities upon carrying companies against engaging in mining or manufacturing articles for transportation over their roads; and, as street passenger companies do not transport articles of manufacture over their roads as a regular business, they are not included within the manifest meaning of the section. The same remarks apply to the sixth section, which imposes the same disabilities upon officers as are imposed by the fifth section upon companies themselves. The seventh section plainly relates to the transportation of merchandise or freights, and hence is equally inapplicable to street passenger companies. The eighth section prohibits any railroad, railway, or other transportation company, from granting free passes to any persons but officers and employes. This section relates to the carriage of passengers only, and it plainly includes street passenger companies, as well as all others, because it expressly mentions 'railroad' and 'railway' companies. But because



it uses both terms, 'railroad' and 'railway,' a most convincing argument arises that the convention considered it necessary to use both in order to embrace both, and hence it must be considered they did not intend to include both in the other sections where only one is used. The force of this argument is greatly strengthened when we consider the ninth section, which provides that 'no street passenger railway shall be constructed within the limits of any city, borough, or township, without the consent of its local authorities.' It is perfectly clear that the convention did not regard the word 'railroad' as synonymous with 'railway,' or 'street passenger railway,' when this section of the article was framed. We think, also, that it is quite clear that the sense of 'competing,' which is the essential sense of the prohibition, is not applicable to the travel upon the streets of cities and towns over passenger railways. The competition by traffic between distant points by rival roads and canals tends to promote cheap transportation, and thereby tends to the public good; but, if this is suppressed by the absorption of one of the competing lines by the other, the wholesale competition ceases, and higher rates soon result. This was the evil which was sought to be prevented by the fourth section of the seventeenth article. It will be seen at once that it is inapplicable to the travel upon streets of cities and towns on passenger railways. The travel over parallel streets is not necessarily a competing travel. Each street has travel of its own, which is conducted upon its own railway. That travel may be almost entirely conducted without competition with the travel upon another, though parallel, street; nor do railways upon parallel streets have the same termini. Many of them, though running upon parallel streets for a considerable distance, diverge altogether from such a course at their extremities. Two roads would be competing if laid upon the same street, and running in the same direction, but that is not this case, and probably is not the case any where in the state. Moreover, no freight is carried upon passenger railways, and it is the carriage of freight that was probably of principal importance in the design of the fourth article. All the analogies which would liken the traffic upon the street railways with that upon the railroads and canals of the state are wanting, and hence we are without authority to impose upon the language of the fourth article a meaning which does not reside in its words, and which does not result by any rational implication. The language used in the fourth section in designating the objects of its provisions, is precisely the same as is used in all the other sections for the same purpose; and when passenger railways are intended to be indicated, a different phraseology is employed. We find nothing in the fourth section indicating that the word 'railroad' was there used in any other sense than that in which it was manifestly used in the other sections; and we are therefore not at liberty to give it any other meaning than is apparent in those sections. We think the court below was right in dismissing the plaintiff's bill. The decree of the court below is affirmed, and the bill of the plaintiff is dismissed at the cost of the appellant.

#### INJURY TO PASSENGER BY CAR DOOR.

*Baker v. Manhattan Ry. Co.*; Court of Appeals of New York, February 25, 1890. 23 N. E. Rep. 885.

The plaintiff in this case was employed as a music teacher, and while going to her school was injured on a train of defendant's road. She was injured by having a finger of her hand caught in the door of a car. Her testimony was to the effect that the conductor signaled for the train to start at the same time he opened the door for her, and that the motion of the car threw her forward, and to save herself from falling she caught hold of the door jam when the door swung shut and injured her. From a judgment for plaintiff the defendant appeals. The court say: "Assuming that the facts are as testified to by the plaintiff, was the defendant guilty of negligence which contributed to or caused the injury? It is conceded that it was the duty of the guard to be upon the platform of the car when it stops at a station, to open the door, and also the gate upon

the platform, so as to afford ingress and egress to and from the car. On this occasion the guard was absent from his post of duty, but it is urged that his absence was not the proximate cause of this injury; but had he been at his post of duty, and opened the door, and fastened it back by the catch provided for that purpose, and opened the gate to the platform of the car, the plaintiff could have alighted without injury. This, however, was not all, for at the instant that he did open the gate he signaled the train to start, before giving her time to alight, and while she was still standing in the doorway, and, by thus starting the train, caused the door to swing to upon her hand. The starting of the train at that instant was the proximate cause of the injury, and, under the circumstances of the case, the verdict of the jury to the effect that the defendant was chargeable with negligence is justified by the plaintiff's evidence. The question as to the plaintiff's contributory negligence we regard as more serious, but we are inclined to the opinion that it became a question for the determination of the jury. If, in opening the door, she had shoved it back over the catch, the door would not have swung to upon her hand; but if, as she testified, the car had stopped, and was standing still at the time she opened the door, it doubtless would not have injured her had she been given an opportunity to alight from the platform before the train was again put in motion, causing the door to close. She had arrived at the station at which she was to alight. She was not compelled to remain inside of the car, and be carried beyond her destination. She but did what nearly every other person would do under like circumstances—finding that the guard was not at his post, opened the door so that she could attract his attention in time to have the gate of the platform open before the train again started." Judgment affirmed.

#### RULES OF EVIDENCE IN ACTION FOR PERSONAL INJURIES.

*Birmingham Union Railway Co. v. Hale*, Supreme Court of Alabama, June 27, 1890. 8 South. Rep. 142.

Plaintiff, who is appellee in this court, was injured while alighting from a car operated by defendant and appellant. She recovered judgment, from which defendant appealed, and the court say: "In order to recover, it is incumbent on the plaintiff to show an accident from which the injury resulted, or circumstances of such character as impute negligence. Railway companies are bound to exercise a high degree of care in providing tracks and plants, locomotives and cars, competent and skillful employes, and all other agencies and appliances required in the safe transportation of passengers and freight. When it is shown that an accident happens which would not ordinarily have happened if due care and foresight had been exercised—such as from the derailment of the train, or defect of the track or machinery, or from a collision, or from the breakage or defective condition of any of the appliances employed in the business, or the method of their use.—negligence may be presumed or inferred; proof of an accident of such nature, or under such circumstances, establishes a *prima facie* case of negligence. *Railroad Co. v. Napheys*, 90 Pa. St. 135; 2 Wood, Ry. Law, 1096, note: 1 Whart, Ev. Sec. 359. The rule is clearly and comprehensively stated in *Transportation Co. v. Downer*, 11 Wall, 129, by Field, J: 'A presumption of negligence from the simply occurrence of an accident seldom arises, except when the accident proceeds from an act of such a character that, when due care is taken in its performance, no injury ordinarily ensues from it in similar cases, or where it is caused by the mismanagement or misconstruction of a thing over which the defendant has immediate control, and for the management and construction of which he is responsible.' The injury occurred on a street-car drawn by horses. When plaintiff proved that on the stoppage of the car, she at once walked out on the platform to get off, and while in the act of alighting, the driver suddenly started the car with a jerk, which caused her to fall, whereby she was injured, she established a *prima facie* case of negligence in the management of the car; the burden of proof,

which primarily rested on her, was uplifted, and the burden of disproof thrown on defendant. She was not required to make, in the first instance, other and further proof that the car did not stop long enough to enable her to get off with safety. On the case made by the evidence, negligence *vel non* became a question of inquiry by the jury on the entire testimony. *Railway Co. v. Hughes*, 87 Ala. 610, 6 South. Rep. 413. When the evidence is in equipoise, the verdict must be against the party on whom the burden of proof primarily rests; but in a civil case a verdict may be based on a preponderance of the evidence, if such preponderance is sufficient to satisfy the minds of the jury. *Vandercenter v. Ford*, 60 Ala. 610. It can seldom be said that the issue is not in uncertainty to some degree, whenever there is a conflict of evidence. The latter clause of the charge requested by defendant to the effect that, if all the testimony in the case left the jury in uncertainty as to whether the plaintiff was injured by the carelessness of defendant's driver, they must find for the defendant, lays down the rule too exactly; the jury would probably have understood from the instruction that they must be clearly convinced. The fourth and fifth charges asked by defendant, as framed, were calculated to mislead the jury as to the measure of proof. *Wilkinson v. Searcy*, 76 Ala. 176; *Lehman v. Kelly*, 68 Ala. 192." Judgment affirmed.

#### NEGLIGENCE OF DRIVER IN STARTING CAR.—

*Augusta & S. Ry. Co. v. Randall*; Supreme Court of Georgia, April 23, 1890. 11 S. E. Rep. 706.

The plaintiff and appellee in this case was injured by being violently thrown from the rear platform of a car operated by a driver of appellant, while she was alighting, after having duly signalled the car to stop, her fall being occasioned by the sudden starting of the car after it had stopped. After verdict for plaintiff, defendant moved for a new trial upon the ground of errors in the conduct of the trial. In brief these grounds were, aside from points on the exclusion of testimony, that counsel for plaintiff erred when, without evidence to sustain the charge, he said to the jury that, but for the fact that the superintendent of defendant had called upon one of their important witnesses, who failed to appear and testify, she would have been present. This, say the court, was an error for which a new trial should have been granted. Concerning the measure of damages the court says:—"The ninth ground of the motion complains that the judge charged that in a case of this kind the damage must be assessed according to the enlightened consciences of impartial jurors. This charge is correct where the plaintiff seeks only to recover for injuries to the person, and for pain and suffering. If the plaintiff seeks to recover special damages, such as expenses of nursing, physician's bill, medicine, etc., it is error to apply this rule to that character of damages. While the declaration in this case alleges special damages, it seems from the record that special damages were not insisted upon, but that the plaintiff sought only to recover for injuries to the person, and for pain and suffering. In this view of it, there was no error in giving the charge. The tenth ground complains the court charged that any pain and suffering or sorrow resulting from the miscarriage, the law says is an element of damage. We would suggest that the word "sorrow" be omitted from the charge of the court on the next trial. It is most too remote to be considered an element of damage, unless it is that sorrow which accompanies the actual injury, and is suffered at the time of the miscarriage. The loss of a child by a miscarriage would effect woman so differently that it would be hard for men, sitting as jurors, to estimate it as an element of damage; and we therefore think it would be better to omit, in the future, any instruction to the jury upon the question of sorrow as an element of damage. Pain and suffering give a wide latitude to juries, and there are very few complaints made of the smallness of the amounts found by juries upon these two elements of damage. Upon the question of sorrow being an element of damage, see 5 Amer. & Eng. Enc. Law, 42; *Bovee v. Danville*, 53 Vt. 190.



(Continued from page 207.)

A. W. Brickwood, Secretary and General Manager of the Russell Street Carriage Company, then addresses the Association, as follows:

As your Chairman has indicated, the street railway people of Cleveland or some one else have captured our car at that point, so that I am not able to extend the invitation that I had intended to extend to this Convention. Several gentlemen have asked me since I came here, what I am doing in a street railway convention. We insist that we have a street car, a trackless street car, which belongs to the street railways and not to the omnibuses or anything of that kind. It is for street car men, and not omnibus men; not competitors, but for extension and use in connection with their street railway lines. We have, to borrow an expression from the electrical men, started on something of an experiment about a year ago. In that time we have equipped five different lines that are in successful operation. We have orders for over three hundred carriages to put on just as quickly as we can have them built. We have negotiations pending for as many more. As to the item of repairs referred to by Mr. Curtis, we have two lines of carriages running in Chicago for the last six months and we have not spent \$100 in repairs during that time. We have had built a street car so far as the body is concerned, which combines the elements of strength, beauty and durability. I have been asked about the strength of these carriages and the load that they will carry. They will carry forty or fifty persons without any trouble. I want to say that beginning at the bottom the wheels are tired with the best tire steel. The wheels themselves are made of the best material; the axles and springs are made from the best oil tempered Swede steel, allowing the body of the carriage to hang low so that passengers get on and off without difficulty on either side of the street. So far as the durability of the cars are concerned, there is nothing to break or give away. I do not believe that a load could be piled on it that would break one. The bodies are built after the style of the most improved street car. The specifications were drawn principally—if my friends will excuse me for using the term employed by a rival house—after the Stephenson specifications for building street car bodies. The sills are of oak, and everything about the carriages is of the best workmanship obtainable.

We now have these carriages in running order and we have patronage, as everybody who comes to Chicago knows, and a great deal more than we deserve from the number of carriages we have. They have been tried and they have proved themselves satisfactory.

We do not propose in this work to take the place of the electric, the cable, or any other system of rapid transit, but merely for short distances where transfer over bridges are necessary or in extension or on good streets requiring a street car and where the public require it, street car men can have advantage of it.

There is no one here perhaps who regrets the fact that the carriage referred to by the President did not arrive except myself. I understand that the steam railroad car upon which it came broke down at Cleveland, and after repeated telegrams, we have found that it could not get here until to-morrow, which will be too late for this Convention to inspect it.

Dr. Everett: What is your motive power?

Mr. Brickwood: Horses.

Mr. Clegg: What is the width of your tire.

Mr. Brickwood: We have found that the most satisfactory width is 3 inches; we have built them from 2 to 3 inches, and we have found from practical observation that the 3 inch tire is the preferable width on block pavements.

Dr. Everett: What is the weight of a carriage?

Mr. Brickwood: The weight of the whole carriage is 3,500 pounds.

Mr. Clegg: I do not see why it should reach that weight; I judged from the papers which I inspected of the cars that the weight would be much less than that.

Mr. Brickwood: They are thirteen feet long in the clear; that is the ordinary size. We make a thirteen foot carriage and a ten foot carriage. The thirteen foot carriage will seat twenty people inside and three with the driver. We also have the plans and are preparing to make a double-decker, so that we may seat people both inside and outside. The weight comes in this way: the wheels themselves weigh about six hundred pounds, the tire three hundred pounds, axles and springs five hundred pounds; and in that way the thirty-five hundred pounds is reached. I have circulars and some photographs, rear views, which give a very fair illustration of a carriage in actual operation. We have them in Chicago and would be pleased to exhibit them to anybody desiring to inspect them, and would be glad, any time, by correspondence or otherwise, to give any of you any information which you might desire.

President Stewart: We have with us a gentleman representing the Ray system; I refer to C. A. Benton of Detroit, Michigan, who will now take pleasure in addressing you.

Mr. C. C. Benton of Detroit, Michigan, as representing the Ray system, then said:

Gentlemen of the Convention: I represent the only single motor that I believe is in successful operation. The peculiar feature of our motor over that of other systems is,

that it is geared to both axles, a construction which permits the use of large wearing parts, slow speed of armature shafts, and therefore reduce friction and long life; it secures perfect insulation between the motor and the truck, eliminating all electrical strain, and making burn-outs from this cause impossible.

By the way, reference has been made to the economy of electrical street railroading, and as to the extent of repairs required. A statement has been made in your presence by Mr. Curtis, which was intended to impress you with the belief that his system reduced the expense of repairs to the minimum. To borrow a slang expression, "I will go him one better." Mr. Curtis says that six cars running for six months at Muskegan, Michigan, required repairs to the extent of \$100. We have twenty-one cars running at Saginaw, Michigan, which have been run for eleven months, and the repairs on the entire equipment have not reached the sum of \$50. and the man who went there to do the winding in case of a break, had nothing to do, and they finally bought him a uniform, and have been using him as an extra conductor on the line. This is absolutely true, and if you don't believe it you can go there and see it.

Some people think we are a little bit new in this business, but we are not. Several years ago, in fact six years ago, Mr. Rae first built an electric motor, and during the time which has elapsed between that time and this, he has been busily engaged in perfecting it. We have during the last two months closed certainly some important, even if they were in the minds of some, small, contracts. I think in the aggregate about—Mr. Curtis, how many cars were in your Rochester contract.

Mr. Curtis: One thousand.

Mr. Benton: Well, ours is not over a quarter of that. [Laughter.] However, we think we can run four times as well and four times as long as the other system, so we will even it up. [Renewed laughter.]

The Detroit Electrical works are in this position; they are sound financially, their guarantees are good; they are prepared to send a truck motor to any responsible street car line having any system and put a car upon it and leave it for them to use.

Now gentlemen, if you care to I can show you a model that I have in my room at the Neil House or, which is better still, we will have one running here to-morrow on the Greenwood and Green Lawn road. It would have been here today but for the same kind of a mishap as that which occurred to Mr. Brickwood with his carriage; the steam railroad company failed to keep its promise in getting it delivered here by the time agreed upon.

Mr. Clegg: What is the weight of your motor as compared with others?

Mr. Benton: It varies very little from the Sprague or the Short. I think it is a little lighter than the Thomson-Houston.

Mr. Clegg: It struck me that it was much lighter.

Mr. Benton: There is but very little difference. The weight, of course, would vary some from this reason, that we weigh them on the trucks and sometimes we have heavy wheels on the truck and sometimes not so heavy, and for this reason the weight varies a little.

President Stewart: Street cars are quite an old method of travel through the country and those who are not acquainted with the gentleman I am about to introduce, may expect to see quite an infirm and decrepid old man, but he is young and active and vigilant, and his cars are in service now as they have been for almost ages. He will tell you all about it, whether the sills are made out of oak or something else. Mr. Brownell of St. Louis.

Mr. F. B. Brownell of the Brownell Car Company, St. Louis, Missouri, then spoke as follows:

Mr. President and Gentlemen:—I did not come here to make a speech, but at the same time as we have plenty of time I do not know that you can use it to better advantage than to hear me [laughter]. I haven't any prepared speech so I do not know when to stop; and like some other things, when they get wound up, they go off and no one knows when they are going to stop [renewed laughter]. If I can say anything that would be of value, I would be very glad to do it. In regard to the car question it is hardly necessary for me to say anything, because if anybody wants good cars, they know where to get them [laughter]. But the leading subject now among street railroad people, I think, is the subject of electricity as a motive power; but it has always appeared to me that the proper amount of thought has not been given to the mechanical construction and operation of the car. Electricity itself is a matter that I know but very little about, in fact almost nothing, but the transmitting of the electric current to the car axles through mechanical appliances is in my judgment far from being perfect. We have a very large electric road in St. Louis now, that has been in operation only a very short time. In conversation with the superintendent a few days ago, he told me that the defects in the electric trucks were very many and that it seemed to him, and to me also, that the people jumped at the construction of the electric truck without giving the matter proper consideration.

In most of the electric trucks that I know of, the motors are located very close to the ground. The movement is very rapid, and the tendency to draw in foreign substances from the street is very great, and I do not believe that we are going to get an economical car until some change is made in the location of your motor. The thought has occurred to me that the present electric car in general use is the ordinary street car, both made more elaborate and finer and larger and better finished inside, but the motors are located on the trucks underneath this car. Now if there is anything the matter with your car to prevent its running, it will be most likely in the trucks. The result is that you have to run this expensive car into your carshed, and throw up the trap doors, and the mechanics get in there with their soiled clothes and greasy hands, and throw tools and traps up on to the cushions in their effort to repair the truck, and the car is very apt to be injured and costs not a little money to put it back. It would seem to me that the better mode would be the use of cars in trains, a motor car with a passenger coach as elaborate as you see fit to use and the more elaborate the better it would be for the car builder [laughter], the motor car to be made small and strong and plain, so that the liability to injury by the handling of tools, and parts of the mechanism of the car would not be much, and then to have that motor car used entirely for that purpose.

I have thought also that the motors instead of being horizontal and close to the ground, should be located vertically and so arranged that every part could be easily gotten out for repairs or removals or renewals, or whatever may be necessary to do with them and the whole system of construction changed to something that is practical and desirable, which the present mode I do not think is.

Then again there is another subject, which I think should be considered, in connection with the operation of these electric and cable roads, and that is the fearful liability to accident. You can scarcely pick up a daily paper, but what you will find an account of some one killed on an electric road in some part of the country. I find that nearly all the electric cars, and nearly all of the cable cars, excepting of course those built by ourselves [laughter], have got a fender or so-called life-preserver, constructed somewhat after the principle of a locomotive pilot. Apparently the parties who first built an electric car, saw the necessity of something and without stopping to think they concluded that the locomotive pilot was just what they needed. Now, the locomotive pilot is not designed to preserve life, of anything that may be on the track. The engineer of a locomotive, if he sees a man or an animal on the track, will try to stop his locomotive; if he sees that he cannot do it, then he will open the throttle and give the engine all the steam she will take and he will knock that object sky high and get it out of the road and thus prevent the derailment of his locomotive and the possible wrecking of his train and great loss of life. Nearly all the switch engines around the yard, where the movement is slow and the liabilities to obstructions is great, are provided with a sort of platform on which a man could jump and be carried along with the locomotive until it can be stopped, thus preserving life as well as preventing the derailment of the engine. This is a subject, I think, it is well for the railroad people to consider; the subject of fenders. There are cases on record where lives have been saved by this style of a fender, and there are many cases where lives have been lost on account of having other styles of fenders.

These two subjects I think are worthy of some thought, and I think if the railroad companies and the motor people will work in harmony on that line, and especially so far as the location of the motors are concerned, they will find that many of the troubles of the street car companies and the electric companies will be removed, and that a large portion of the money that is now used to pay the cost of repairs, can be utilized as dividends, which I am sure will suit you all very much better.

President Stewart: I hope that the afternoon will be long enough to give every gentleman present an opportunity to say something; but not to depart from the first principles for which we are assembled here. We had better give the street railroad men now an opportunity to be heard. I hope that Mr. Clegg will succeed in convincing the supply people that this fraternity is glad to have them meet with us. I will introduce to you now Mr. Clegg, President of the Oakwood Street Railroad company of Dayton, Ohio. [Applause.]

Mr. Clegg: Mr. President, I knew that we would not have time enough to go around [laughter]. Mr. Brownell has consumed it all in his remarks [great laughter].

Mr. Stewart: Yes, Brownell talked too long.

Mr. Clegg: He has talked too long entirely; it don't give me any show at all [continued laughter]. I want to say this, however, that while I started out with a feeling that this meeting would be a sort of disappointment to-day, I am very agreeably surprised, for I find that we are having a very good and very profitable time, and I will therefore give away to them very cheerfully [applause].

President Stewart: I hope you will all be present at the banquet to-night for Mr. Clegg has his speech preserved for that occasion. Mr. Clegg, you know, is a banquetter [great laughter].

Mr. Johnson representing the Northern Car company, of Minneapolis, is present, and if he



desires to say anything we would be glad to hear him.

Mr. Johnson: The Northern Car company is, comparatively, a new company, and comparatively unknown to the general street railroad men of the country. The company is only about four months old. They have at Minneapolis, I presume, the largest street car factory in the United States, if not in the world. Pullman has about 32,000 feet of working surface. The Northern Car company has about 75,000 feet of working floor surface. The Northern Car company has sufficient capital to run its business; it has new machinery and all of the improved appliances necessary to make the finest and best street cars. They have a system of electric lights by which they can work at night when it is necessary; and in fact every contrivance in the way of machinery, tools, buildings, dry-houses, &c., by which they can make practically perfect cars.

I have been selling cars for over two years and have been more or less connected with street railway interests for ten or fifteen years, and since I have been selling street cars I think I have never found street cars so perfect and giving such universal satisfaction as the street cars turned out by this Northern Car company. They have employed the best superintendents they could get in the United States, or that money will hire for the different departments. They have a gentleman from the Gilbert Car Co., who has had a long and successful experience in building street cars as mechanical superintendent; we have from Pullman the gentleman who has done all the fine line work and painting as superintendent of that department, and we have one of the most highly educated and ingenious and thoroughly posted draughtsman that I know of in the business. Some of our recent contracts are for companies in Lincoln, Nebraska, Keokuk, Terre Haute, and many other points which it will not be necessary for me to mention. The parties that have received these cars say that they are perfectly satisfied and delighted with them and that the prices are satisfactory.

That is about all I want to say, gentlemen, that if you want any street cars I am here to cultivate your acquaintance, and if you want any supplies write me and if it is necessary I will come and see you and will do the very best I can to capture your order. That is what I am here for. I'm after business.

President Stewart: While the street car people of Ohio were looking around to find a substitute for the mule and the horse, a gentleman who is a pioneer in the adoption of the overhead system, and who is now with us, saw fit to investigate that system and largely adopt it upon his lines in Cleveland. I have now the pleasure of introducing Dr. A. Everett of the East Cleveland Street Railway company [applause].

Dr. Everett: Mr. President and gentlemen of the convention, I do not believe in much talk. All I have to say to you is to come and see me. We will show you the Edison system in practical operation, the Sprague system, the Short system, the Westinghouse system, the Rae system, and very soon, within two weeks, we will show you another system from Baltimore. Now I know when to stop [great applause].

Dr. Stewart: Say, Dr., you told me you could not be present at the banquet so I have arranged for you to make your banquet speech this afternoon.

Dr. Everett: I do not propose to be at the banquet; I have no faith in banquets.

President Stewart: Mr. Ferdening, President of the Dayton Street Railroad company, is present and we would like to hear from him.

Mr. C. J. Ferdening then addressed the addressed the Convention as follows:

Mr. President, I do not really know anything that I can say which will be of any special interest to this convention. We are operating a street car line in Dayton, which we think is doing very well. We still stick to the mule and the horse. We have had under consideration, and have investigated somewhat, the different modes of motive power, and had thought very seriously at one time of adopting electricity as a motive power. Yet we were not fully convinced that electricity had yet arrived at that stage when we felt justified in adopting it, and preferred to let others do a little more experimenting. I have been told by gentlemen, who had a great deal of experience in electricity as a motive power, that they are very well satisfied with it, and I have no doubt, but that it is the coming motor for street car service.

President Stewart: I see next to Mr. Ferdening Mr. Rodgers, of Dayton. Perhaps he has something of interest to communicate.

Mr. Rodgers of Dayton: I do not believe Mr. President, I have anything that will be of interest.

President Stewart then called on W. J. Cook, Vice President of the McGuire Manufacturing Company, who said to the Convention:

Mr. President, I have been very much interested in what I have heard this afternoon. I am here to learn. I commenced building trucks several years ago when cables first came in. When electricity was first introduced, we had a truck which we thought was peculiarly adapted for electricity. I found out from the electric people that they had designed that the standard should be thirty horse power.

I figured from thirty horse power up to a truck, following the suggestions of the electric people largely. When I had completed my truck, my electrical friends said I was wild, simply crazy; that I had 1500 pounds more than I should have. I insisted that my figures were right. The result was I did not sell any trucks for electric motors for six months; they thought I had too much strain. In the last year I could not make trucks enough; I am making them heavier than ever and do not think that I am heavy enough. They have been figuring the standard on the other side from the basis of a two horse team and came down, while I started from 30 horse power and went up. We are not quite reconciled yet.

I am glad to hear what my friend, Mr. Brownell, has to say in regard to it. It coincides with my opinion exactly. I believe that the present mode of connecting the motor to the truck is not right. You are now getting the motor down in the mud and the dust and the dirt, and this of course creates friction in the gearing and that cuts and consequently requires repair. I do not know how the remedy is to be accomplished, but I have an idea that we will have to get up on top with our motive power. We are at the mercy of the electrical and street railway people. We want to build whatever they want. We have gotten out what we believe is pretty near the requirements of today, but we are ready to adopt any new device or to make any modification that the demands of the street railway people may require.

We have very recently, at very great expense, gotten up a frame made of pressed steel, the entire frame consisting of only four pieces. Noise has been a disagreeable feature to some extent in the electric motor; some motors are very noisy and some trucks are very noisy. We have gone to work and made a truck of very few pieces, less than half the number I believe used in any other truck constructed to-day. We had it on exhibition at Buffalo; a pair of trucks under a double truck car. We believe that that solved the question to a great extent of the expense as to wear and tear of truck and motor. Until very recently we have not had the matter taken up. We have now under contract 200 pairs of trucks for these three different lines in Pittsburgh, double-trucks; also for Sioux City; Salt Lake City; Los Angeles; Oakland, Cal., and several other places, where they have recently adopted the double truck car, 24 to 30 feet in length. We are of the opinion that that is the coming car for street car service. One long car instead of a trailer. It makes less expense on the car, the friction will be practically nothing and it makes a saving of flange wear on the tire.

Mr. Clegg: What will be the wheel base?

Mr. Cooke: 4 feet six inches on the long car, just enough to let the motor in; the electrical people wanted us to make it longer, but we are trying to get the wheel base as near the gauge of the car as possible, and we have adopted a standard of 4 feet 6, and arrange it so that we can get all of the present motors in that wheel base.

Mr. Rice of Pittsburgh, who has used these short wheel based trucks for a good many years under his cable cars, is of the opinion that it is the most economical style of truck to use, both as to rail wear and wheel wear and motor wear. On our double truck we extend the spring base 3 feet wider, thus doing away practically with oscillation of the car, which is also very hard on the rail wheel and motor.

I do not know that there is anything further I can say. If there are any questions, I would be glad to answer them.

Secretary Hanna: Mr. Cooke can you tell the gentlemen present anything about the new electric heater we were talking of this morning?

Mr. Cooke: Yes, just a little. The gentleman representing the heater expected to be here. He is an old school friend of mine, and that accounts for the interest I take in it. It was invented in Minneapolis. I have one in my house, in the laundry. I take off the burner in the house and connect the wire and my laundress irons all day by means of this heater. The iron only gets so hot, it can't get any hotter, and it holds that heat a long while.

He has arranged a heater for a street car. I am sorry he is not here to explain it himself. It is merely a ribbon that runs along under the edge of the seat, I think about 6 or 8 inches wide and possibly a half or three quarters of an inch thick, and with the current from the trolley he heats the car perfectly to any degree of heat that is necessary. There is a button attachment at the motor man's command, so that he can give the car quarter-heat, half-heat, three-quarter heat, or full heat, just as the demands of the weather require.

I merely make this statement in behalf of my friend, who has just recently taken hold of it, and who expected to be here to-day and give you an exhibition of it.

Mr. Ferdening of Dayton: I notice that there is considerable paving going on here in Columbus, and as street railroad men are all more or less interested in the requirements that are made upon them in regard to paving, I would like to

ascertain such information as we may be able to get from some of the gentlemen here present who have had experience on this subject, in regard to the cost of paving with brick or stone block which I find are being used here.

Mr. Stewart: If there is a brick paver or stone paver present, we would like very much to hear from him. I don't suppose there is. Then the next thing in order will be a speech from the man who is next to a paver, and I don't know of anybody who comes nearer to that than the editor of a paper. I will therefore introduce to you Mr. C. B. Fairchild, of New York. If he can pave some of these supply men with brick or stone or something else, we will now give him the opportunity to do so.

Mr. C. B. Fairchild then addressed the Convention as follows:

Mr. President and gentlemen: I am very glad to have the opportunity of looking in your faces and of making myself known to you at this time. The hour is too late for me to enter into much of a discussion. I would like, however, in the first place to disabuse your mind of one thing. The street railway men seem to think that the technical press are very much on a par with the reporters of the daily papers and sometimes you have been afraid to let us into your meetings and afraid to talk before us as you would among yourselves. Now we wish very much that you would regard the technical press, at least the paper that I represent, not as a newspaper watching you, to pick flaws in your work and criticise you unfavorably, but as one working in the interests of the street railway companies. We would like to have it understood that we are, to all intents and purposes, a street railway company, interested in the same line of work you are interested in, and that your interests are our interests; that we come to your meetings, not as news reporters, but to learn and to publish that which will be a benefit to you and others. You need not be afraid of our publishing anything that is said in confidence among yourselves.

Now just one word in regard to conventions, and particularly in regard to the Ohio convention. Those of you who have read our paper recently have probably noticed that it urges that more attention be given to these conventions. It seems to us that you do not fully appreciate what a power you might be in this State if all the street railway people felt obligated to be present at these meetings, or at least contribute papers and take hold in earnest and place this association on a solid foundation.

We hear a great deal of complaint, Mr. President, about unfair legislation, both from state and municipal authorities. I believe that if there is any more unjust or unfavorable legislation, by which the street railway men suffer, that they will have themselves to blame for it. I believe that with proper organization among the street railway men of the State they could influence legislation, or at least stop unfavorable legislation against street railway companies. It seems to me that the most important object to be attained by this convention, is to secure some remedy in this direction; take up this subject as was suggested in the papers read at the National convention last year and this year by Mr. Scribner, and pursue it in the line which he has indicated; present the matter to your legislature and keep it before them until you have secured your rights; remember the old adage "They have rights who dare maintain them." if you dare maintain your rights before the Legislature, undoubtedly you can get them.

You are a power and by united effort you can get justice at the hands of your law makers, and make them to understand that you are determined to make your business more pleasant, more prosperous and more satisfactory to yourselves and to the community. There is a great deal which might be said upon this subject. I simply speak by way of suggestion. I do not think any one should go away from here feeling that this convention has been a failure by any means, but let each member see to it that the interest which has been manifested this afternoon be continued and increased among all the street railway men of your state and that at next year's convention you will have a large meeting, and one that will exercise a salutary influence over law makers, I hope your meeting will continue to be profitable and pleasant.

President Stewart then asked if Mr. Beggs or Mr. Lewis, representing the Edison General Electric company were present and desired to be heard.

Mr. William Hand responded to the call of the chair and stated that to his regret neither Mr. Beggs nor Mr. Lewis were present, but that as he was working in the interest of the Edison General Electric company, as an electrical expert, he would like to state that he, for the Edison company, had just completed the installation of the Glenwood & Green Lawn Street Railway, of Columbus, Ohio, extending about four miles west from High Street, with five cars with the Edison system. The road has been in operation over two months and the repairs on the cars during that time have not amounted to one dollar; there has not been an armature taken out of any of the cars.

Mr. Hand continuing, said: As the gentlemen here present representing other systems had spoken of the practical operation of their



respective systems, I did not want to let the opportunity pass by without endeavoring to impress upon the members present the fact that we also have a system, which we think is both efficient and economical. I will take great pleasure in having any and all persons present, ride over and inspect the equipment of the road I have just alluded to.

Mr. Johnson of the Northern Car company, at this point referred to a brick which was being manufactured at Galesburg, Illinois, and which was claimed to be the best paving material yet discovered.

President Stewart: I will say to Mr. Hand that quite a number of the delegates had the pleasure of riding over his road and that if the revenues are to-day about twice what they were yesterday, just give the street railway papers credit for it, because they put the money in the slot [laughter].

I wish to say that at the next meeting of our Association, on the second Wednesday in November, at Akron, Ohio, I have no doubt but that every street railroad man in the State of Ohio will be present. Just at this time there is so much going on in every city and village almost, toward improving the systems and changing the systems that they have had in use from horse to electric or cable, that it seems to be necessary for the street railway people to attend to their business at home instead of coming to this convention, although we were in receipt of a communication from almost every road in the State of Ohio that some of their representatives would be here. Litigation of an important character in Toledo has called a number there; trouble in Cleveland is keeping a number there, and so on all through the state. There is no doubt whatever but what the Akron meeting will be a very interesting one for the reason that there will be papers prepared upon all of the subjects that will be of interest to the fraternity in the state as well as to the fraternity at large, and I hope that all who can find it agreeable will be at Akron, and I feel safe in saying that every road in the State of Ohio will be represented at Akron by one or more delegates.

Mr. Clegg: I was disappointed in the kind of paving that this newspaper man talked about, paving the way to legislation and all that sort of thing [laughter]. Mr. Ferdening, I think, was sincere in asking about street railway paving, and I do not know anything more interesting than that. I do not believe there is anybody here from Columbus at this meeting who can tell us what they are doing in Columbus in the way of paving. To us in Dayton it is a very interesting question. I was going to say that as we have heard from all of the supply men, I now move we adjourn to meet at Akron on the second Wednesday in November, 1891.

President Stewart then, after putting the motion to the convention, declared the Association adjourned to meet at Akron, Ohio, on the second Wednesday of November, 1891.

### The Banquet.

At 8:30 p. m. the delegates and their friends, 26 in number, entered the spacious banquetting hall of the Columbus Club, and sat down to the following:

#### M E N U .

HUITRES.

Shrewsbury's.

*Sauterne.*

POTAGE.

Consomme.

HORS D'ŒUVRES.

Olives—radis—Praline au sel.

ENTREE.

Ris de veau, saute.

*Chambertin.*

Sorbet au rhum.

ŒUFER.

Caille a la Columbus.

Salade de celeri.

*Moet & Chandon.*

Fromage—Cafe—Cigars.

The table was handsomely decorated with red and white China asters, with brake fern and smilax, while a beautiful nickel model of the Milliken pole stood in the center.

After the "roquefort" had been disposed of and coffee was served President John N. Stewart, toastmaster of the evening, addressed the banquetters as follows: *Gentlemen:* At all the annual meetings of this Asso-

ciation it has been the custom for it to pay its respects to the city in which it holds its meeting; and, following out that custom, I have the pleasure of introducing to the "minority"—[laughter]—the members of the street railway fraternity who are present—I think they are three in number—as a representative of the city of Columbus, the Secretary of the Board of Trade, Mr. Charles G. Lord, who will respond to the toast "Columbus." [Applause.]

Before Mr. Lord begins, in order that none of the other gentlemen may think that they are being crowded out, I will state that we will receive no excuses whatever, and when any of the gentlemen are called upon to respond it signifies that they must respond, and if they do not, we propose to have them retransfer all of the street railway stock that has been delivered to them. [Great laughter.]

Mr. Lord: Mr. Toastmaster and gentlemen, Mr. Stewart invited me here this evening to meet some of his friends, but never mentioned the fact that I was to say anything. Your toastmaster spoke of me as being the Secretary of the Board of Trade, and as such I must take refuge behind one of the strict rules of the Board of Trade, which provides that the Secretary shall at all times be "seen and not heard." [Renewed laughter.] That is one of the cardinal rules upon which the Board of Trade is founded, and as there are so many members of the Board of Trade present to-night, notably those who have just come in, I would certainly not take the liberty of breaking so important a rule in their presence. [Continued laughter and applause.]

If I am to respond to the toast "Columbus" I can not sit down without saying just a word about our city. The city of Columbus feels honored in having you with it at this time as its guests. The Ohio State "Tramway Association"—I believe it is called and not "street railway"—is the guest, I believe, to-night more particularly of our local street railway people. We feel, of course, that a great deal of interest is centered in our street railway system at this time. Columbus has been progressing in its street railway facilities, and it has yet perhaps some progress to make. We know that meetings of this kind will add zest to the proposed advancement in street car facilities.

We have here a growing city, a city that a few years ago, a time well within the memory of Mr. Huntington, and especially of Mr. Deshler, who is, we may say, the Nestor of the people present to-night as representing Columbus, was composed of but a handful of people; we now have a thriving city of 100,000 people, with the expectation that in the year 1900 we will have 200,000 people. The street railway facilities are expected to keep pace with this growth and therefore we can all say that we wish you success in all your movements.

I can only add that, as representing the business interests of Columbus, as indicated by the toastmaster, I may say that the city of Columbus is glad to have you here, and extends to you its hearty good will.

In closing I will say, in the language of the immortal Bill Nye:

"When you go forth, go, gentle brothers, go;

Go out to make your fame;

Tell everywhere that you have went

They will be glad that you have came."

[Great laughter and applause.]

Mr. Stewart: It is now proper, I think, to call upon some of the gentlemen who have not participated in the elegant repast with which we had the pleasure of regaling ourselves. Consequently there are no obstructions in the way, and they ought to be able to dish us up a pretty good speech. I will therefore now introduce to your favorable consideration my friend, my little friend, Mr. Huntington, of Columbus.

T. W. Huntington, of Columbus, then said:

Gentlemen: If I had known that I was to be the second speaker here to-night I probably would not have come up here at all. I am indeed glad to meet you all, and, as I am neither a street railroad nor a tramway man, I may indulge in a little reminiscence of another kind of transportation. Columbus when I first knew it was an exceedingly muddy hole. Away back in the time of the Henry Clay campaign my friend, Mr. Deshler, who is well known to be eager in the management of his small finances, being an ardent Whig, made a wager with a friend of his of \$5.00 that Henry Clay would be elected. Much to his chagrin Mr. Deshler lost the wager. The loss of that \$5.00 rankled in his bosom for many weary years. At last, on a June evening, he met that same friend in company with a few others, and this friend offered to bet him \$5.00 that a certain person could run around the State House square while Mr. Deshler ate a certain number of crackers. Mr. Deshler thought it a golden opportunity to recover his money and at the same time to witness this new method of transportation. The person to do the running started, and Mr. Deshler at the same time endeavored to perform his part of the contract. The man ran like a scared hare, and when he got nearly around the square Mr. Deshler was still busy on his crackers, and when he came up the starting place there was Mr. Deshler with half a cracker in his hand his mouth so full of the crumbs that he could neither swallow them nor get rid of them, but his friends heard him say: "By —, I am gone!" He had lost another \$5.00—[great laughter]—but he had seen another kind of transportation than that used by the railway companies. [Continued laughter and applause.]

Mr. Stewart: Gentlemen, I think it is very proper, as we are now getting well into the secrets of the railway business in Columbus, that we hear from Mr. Deshler. Mr. Deshler, if you have no objections, we will now give you an opportunity to tell your side of the story.

Mr. Wm. G. Deshler then said:

Gentlemen: I came here just for the purpose of

making a speech and nothing else. [Laughter.] I met a friend of mine on the street a while ago and he said that Mr. Huntington and I were expected at this banquet to-night, and were expected to make speeches. I went out to Judge Thurman's to have a little quiet talk with him, and, if possible, gather inspiration for the speech I expected to make when I came back.

The trouble, Mr. President, in the race referred to by Mr. Huntington was, that I miscalculated the gauge; I thought it was a narrow gauge, instead of a broad gauge; I miscalculated those hoofs of his [laughter]. I had walked around the square a good many times, and I knew it took just 600 steps, but I forgot that, every time he took a step, he added—by reason of those hoofs—three feet to the length of each step, and hence he got around before I got through with the crackers [renewed laughter]. Now that is the other side of the story.

I am very glad to be here and very glad to meet you all. Most of you are strangers to me, but I am glad to have you with us. Everything the "Lord" says, you know, is good and to follow him is an honor [laughter]. Mr. Hayden, I believe, is your president or retiring president. I can simply say that you have no better man in the United States for your organization than Wm. B. Hayden, for I have known him since he was born almost [applause]. He is a modest man, but he knows a great deal; he knows a great deal more than he can tell. His father was a man who had no tongue at all, but he had lots of intelligence and shrewdness. There may be plenty of men in your association who are as good as Mr. Hayden, but you have none better [applause]. You have, I see, in your Association, also other elements of strength. You have an element of beauty in my friend Sheldon here—just look at him [laughter]; I don't think with the exception of your president, and that gentleman sitting over there, who is a stranger to me—he is from Chicago I believe (Mr. Abbott) [continued laughter], there are no more beautiful men in the street railway business than my friend Sheldon. If any member has any doubt upon this subject, Mr. Sheldon will now stand up for inspection [more laughter and applause].

Mr. Stewart: It might be well at this time to give the supply man an opportunity to be heard, especially as the street railway men are largely in the minority (this is a stock-holders meeting, gentlemen) [merriment]. I have the pleasure of introducing to you now a gentleman who will probably be a factor in the street railway systems of Columbus at some future day. I believe you are expecting to adopt the electric system or the cable system, the motive power of which will be steam, in the main supplied by the coal merchants. Mr. Morton respond to the sentiment "Coal."

Mr. J. S. Morton, of Columbus, said; I am somewhat at a loss to know just how to respond to this toast. The trouble with the coal man is, lack of cars to supply customers with fuel. I do not know that that is the trouble with street railway companies, for generally there are plenty of cars. I have seen them so crowded, but there is always "room for one more." That is the only reason I could give for my being present here to-night, that it was found that there was room for just one more and hence I was drafted into the service.

The speaker then referred to the street car as a means for killing horses and breaking up carriages, and then referred to the habit of some people in buying a farm at a few dollars an acre out beyond the suburbs of a city, and then berating the street railway company for not extending their lines out to their suburban addition in order that they might unload their property to would-be purchasers desiring street car facilities.

Mr. Morton then referred to the oscillation of the Columbus street cars as producing an effect somewhat similar to a banquet given in honor of the Ohio Tramway Association.

Mr. Stewart: As Mr. Brownell seems to take issue with Mr. Morton in one of his statements, we will now give him an opportunity to speak his speech.

Mr. Brownell, of St. Louis, said: *Mr. Toast-master and Gentlemen:*—It is a fact that street railroad companies are short on cars, very much to my regret. If they only knew how anxious we were to supply the deficiency, I am certain they would take in the situation and give us a chance. I came here to-night to eat, and not to talk. I am a great deal like the chap who went to see his best girl. He sat down a little ways from her, and kept working his chair up toward her, and finally he got it right close up to her, and he says "Now look here, Sarah, you know I can't talk; I can't say anything, but I will take you behind the door and can hug you as well as any man you ever saw." Now if any of you know of any street railway company needing cars, I am ready to supply them as well as any one in the business.

Mr. Stewart: Perhaps at this time it would be just as well to give the electrical men a little opportunity, they will take it anyhow [laughter], and we might as well give it to them now. I will introduce you to Mr. Charles A. Benton, of the Rae System, of Detroit.

Mr. Benton: I hold in my hand a little card which says "Columbus Club, Nov. 19; 7:30 P. M.; James Goodell Steward." Naturally a man would suppose that was an invitation to come and dine here. I came and dined and have dined well, and have enjoyed every moment of the time since my arrival. I fear, however, since I am called upon so suddenly to make you a speech, that some good friends have set up a job on me. Mr. Benton then proceeded to bear out his reputation as a *vaconteur*, and as such proved quite a success.

Mr. Stewart: Perhaps we ought to hear from another electrical man. I refer to Mr. Alex. Lewis, of the Edison General company.

Mr. Lewis: Gentlemen, I appreciate the job that Mr.



Benton put up on me. It was an accident, my trying to knock him out when he was called upon to address you. I assure you it was from mere force of habit. The only way, however, in which I can beat Mr. Benton to-night the most successfully, is in *time*. I will therefore thank you for your courtesy and will ask you to call on some one else.

Mr. Stewart then called on Mr. Andrews of the Brill Car Co. of Philadelphia.

Mr. Andrews: Mr. President, as the Brill Cars speak for themselves, I hope you will excuse me from making any special remarks about them.

Mr. Stewart: Does that account for the squeaking in the street car we rode on to day? [Laughter].

We have had a very nicely "cooked" banquet this evening, and I will now introduce you, not to the "cook" but to his namesake, Mr. Cooke, of Chicago.

Mr. Cooke, of the McGuire Manufacturing Co., then referred to the progress and advancement made in applying electricity, as a motive power, to street cars. He then referred to the little that was known on the subject of electricity a few years ago, and gave it as his opinion that there was much yet to be learned on this subject. He however expressed the belief that electricity was destined to supplant the mule and the horse as a means of propelling street cars. The speaker then related an amusing incident which occurred in a Labor Day procession, in one of the large cities, where a mule and a horse had been installed as passengers upon an electric car and the laboring men very promptly responded to the suggestion by repeating what an old darkey said when he first saw an electrically propelled car running through the streets of Montgomery, Ala.

"White man freed the nigger first

Den he freed de mule."

[Laughter and applause.]

Mr. Stewart then called upon Mr. John N. Reynolds, editor of the National Car and Locomotive Builder, "Supplement," who responded as follows:

Mr. President and gentlemen, your toast master has introduced me as representing manufacturing interests. I am sorry to say that I am not a manufacturer. I wish I were; probably I would be in a better position than I am now as simply a newspaper man. If you will allow me to go into a little matter of history connected with street railway interests, it may prove of some interest to those present. Of course I know it is wrong to talk about myself, or what I have done and shows rather bad taste, but I am simply doing this to illustrate to you the immense strides that the street railway business have made during the past three years. Some 19 or 24 years ago I conceived the idea of publishing a Directory of all the street railway companies in the United States and Canada. At that time I was engaged in the compilation of railway statistics and of course had to visit most of the towns and cities in the country, and thus had an opportunity of gathering information about street railway people that few others probably had. I put it into the form of a supplement to the *Car Builder*.

In order to defray some of the expense incident to its publication I solicited advertisements from the leading manufacturers of railway materials. A great many of the manufacturing concerns insisted that I was foolish in attempting to get up such a publication because the street railway interests were so small that I would only lose my money and my time for my trouble. I published the list, however, and, by so doing, opened the eyes of the public to the immense interests of the street railway systems. Then it was that a few of our leading street railway men got together and formed the American Street Railway Association which, as you all know, has proved a very great success. After that, I was solicited by a number of street railway men to publish a paper in the interests of the street railway business, but I did not think that there was sufficient money in it to warrant me in neglecting my other interests; so I refused. But I have been very sorry that I did not do it, judging from the success that the other papers have made in that line. Shortly after that the *STREET RAILWAY GAZETTE* and the *Journal* were published, and I think gentlemen, you will agree with me that the present boom in the street railway business is owing in a large measure to efforts made by the publishers of those two papers. [Applause] Since then there has been quite a number of electrical papers started and they also have added a great deal to the improved methods of transportation [applause].

Toastmaster Stewart: I am reminded at this time of a little story I heard the last time I was in New York. An Irishman who had just landed at Castle Garden and was proceeding up town found a lady who was regretting the loss of a pet parrot. This lady, who was very anxious to find somebody to recover the parrot, contracted with the Irishman to have him restore to her the bird. So he clambered up into a neighboring tree where the bird had taken refuge, and when he got up pretty near to where the parrot was the bird said: "Paddy, what do you want?" Paddy looked up and said: "Begorra, you will excuse me, sir; I thought you were a bird." So he goes back to the lady and says: "Lady, you asked me to find a bird, but the bird I found is a man, and you will have to excuse me from interfering in domestic affairs." [Laughter.]

Now I will introduce to you for your consideration, and allow him to defend himself, Col. Parrott, of Columbus.

Col. Parrott: Gentlemen, there are some persons who presume that the street-car men have a disposition to impose upon the public, but I am very much inclined to think that they are disposed to impose upon individuals to-night—[renewed laughter]—for I came in here at the invitation of my good friend opposite, with the understanding that I was to be only a listener. It is a pleasure to me to meet all the street-car men, the men who have done so much for the comfort and prosperity of the community, which comfort is realized per-

haps not any more at any time than when some other people propose to take charge of your lines, as they did once or twice in this city recently. They had something of a monkey and parrot time between the street car men and others. I came here to-night more particularly to meet a special friend of mine, who, I understood, would be present this evening from Dayton. He is somewhat like Mr. Deshler has characterized the Haydens. He has the faculty for making money, but is not a good talker, and therefore, I presume, has absented himself from this banquet. Now a "Parrott" ought to be able to talk! But I, unfortunately, do not belong to that class of birds. I was a different breed—[laughter]—and I can only say that I have not been participating in your councils. I do not know the subjects that you have had under discussion, or what are the matters in controversy between you, and as I do not desire to antagonize the interests of anybody present, or say anything which would not be pleasant to you, I therefore feel disposed to take the position of a gentleman I once heard of who was called upon to take part in a discussion, a very animated one, between a couple of gentlemen as to the relative merits of the society which dwelt in heaven and the society which dwelt in hades. He respectfully declined on the ground that he had friends in both places. [Laughter and applause.]

Mr. Stewart: The street railway papers are well represented here to night, and in order that you may have the pleasure of seeing the men who write you up, or at least one of them, I will now introduce to you Mr. Fairchild, of New York.

Mr. Fairchild: I am very glad to make the acquaintance of the gentlemen present. As this is the first time I have been called upon to represent our paper or speak for the paper at a banquet, I came here entirely unprepared for such a task. When your toastmaster asked me this afternoon if I could say something I could not decline, and in order that I might not fail you entirely I went to my room and have written a few notes in pencil. If you will pardon me I will read them, and you will have to accept them as my speech to night. I hope at another time not to be forced to read what I would like to say.

I esteem it a privilege and a pleasure to speak on this occasion, and in behalf of the representatives of the various journals present, I desire to thank the association for the cordial welcome we have received. Our position, or business gives us "power to do," and while we do not claim to be as expert in the way of street railway building and management as are the members of this association, yet from the opportunities we have of studying the work that is being done, in various localities, we are able to advise and suggest, basing our opinions on the best practice of the day. We try to collect and disseminate the knowledge that is of most worth to street railway men, but this is only a part of our mission; it is ours to help introduce, through our advertising columns, the seller and buyer to each other. It is not our province—for this is assumed by the daily press, to criticise the management of any particular line. Our interests are identical with those of every street railway company, and we desire to be taken into your confidence, and not regarded with suspicion as the daily papers are in some localities. While we believe the technical press has been a power in the development of the street railway business, it does not seem to us that you derive as great benefits from it as you might. You are not as responsive a class of readers as we would like. By the word responsive, I do not mean flattering statements, merely that you like such and such an article—editors are human, and such things help to lighten our toil—but a criticism pro and con; and the giving of such information as you may have gained that you think may aid others, and asking for what you desire to know, in other words making the papers more of a medium of communication between yourselves. But enough in this line.

We desire to congratulate you on the advance made in methods of mechanical traction, lifting the business to a higher level, and giving the managers an opportunity to study and broader development than was possible when animal power only was employed.

It has been said that "the railway is the great civilizer," and your president in his address this morning said your business seems to be peculiarly near the people, for you transport them daily from home to home, and from the workshop to these homes. As such, the business should bring to the management the highest satisfaction, and since it is not always so there must be something wrong. The wrong may all be on one side, or both may be equally to blame. Whatever the difficulty, a remedy should be devised. "They have rights who dare maintain them," and it means to us that if the street railway companies of the great state of Ohio go on year after year suffering from unjust state and municipal legislation without any organized effort to correct or prevent it, then you have yourselves to blame. The public must be educated as to the proper treatment due to corporations. You must take them more closely into your confidence and tell them everything except your business secrets. The companies of a city should also be a unit and work in harmony. Speaking now from a business and not a moral standpoint, it seems to us that every manager should bend all his energies to improving his particular line, and give the best possible service. Every man has a certain amount of vital energy and if he spends a part of this in studying how he may defeat the movements of his rivals, or in seeking how he may get an advantage over them, he has just so much less to be utilized in the development of his own business. But I am touching on delicate ground, and will only remark further that the rapid growth of the street railway business during the last few years is only a foretaste of what is yet to come. And it is our opinion, although we are not

prophets, nor sons of prophets, that its development in the near future is going to be more rapid and extensive than any other line of business in this country.

Gentlemen, I thank you for your attention.

Mr. Stewart: It is not all of us who have the pleasure of representing the horizontal and the perpendicular at the same time. We have with us a representative of both an able gentleman who can talk from the base of a perpendicular and horizontal at the same time. We will now be addressed by Mr. Morris, of Millikin Bros.

Mr. Morris: Mr. President and gentlemen: It is an unfortunate thing for you, I think, that you don't know me better. If you did, you would never call upon me to make a speech. I think your calling on me must have been due to my friend Mr. Cavell. He has broken faith with me and I must warn you to beware of him, for he is liable to do it again.

You have a very beautiful city; it needs just one thing more to make it still more beautiful, and that is an extension of your electric street railway [applause]. You have some of the finest streets for electric railways that can be found in the country [renewed applause]. You will find them immediately an advantage to your city, and I am in hopes that the extension will be put under way at once, and that I will be called upon to again visit your pretty city with a view to introducing our perpendicular, as it stands before you (referring to a model in the center of the banquet table, trimmed with ivy) in the shape of a pole.

I dislike to talk shop at a banquet, but I have nothing else to talk about at the present time. I will say that there are lots of poles, some wood, which are of no use; others of iron or steel which are very good in their way; but if you want the best that can be got, as I am sure Columbus will, you will have to come to the Millikin pole, and that you will find a thing of beauty and a joy forever [applause].

Mr. Deshler then referred to Columbus as it was 40 years ago, following up the development of the city and the street car facilities, referred to his connection on behalf of the strikers in the recent street car strike on the Columbus Consolidated, and concluded his remarks by expressing the hope that the Columbus Consolidated Street Railway company would at no distant day, adopt electricity as a motive power on its various lines.

Col. Parrott: I would like to ask Mr. Morris if his system is in use on Illinois street in Indianapolis?

Mr. Morris: No, sir; it is not the pole in use at Indianapolis. This pole is adopted in Buffalo, Jersey City, Newark, Pittsburg, Birmingham, and several other points. This pole was the result of a suggestion of mine in March last. We at once went to work manufacturing the poles at an outside shop. The business has grown so much that in the past four months, we have booked orders for 7,028, to be very accurate. We have been compelled to erect a shop of our own and are now prepared to furnish you with poles just as fast as you can order them.

I will say that we also have an attachment to this pole by which it can serve the double purpose of carrying an arc light as well as the wires for street cars.

Mr. Stewart: Perhaps it might be well for me, as President of the Association, to say, in reply to the remarks of Mr. Deshler, that we are not fortunate enough to own all the stock of the Consolidated Street Railroads of Columbus. But if Mr. Deshler will turn over some of his stock to members present, it might be divided pro rata among us and then we might favor him with an electric system on poles instead of horses.

There are a number of men here who are yet horsemen, some are cable car men, and some are electric car men, both storage and overhead and otherwise. Among all the various systems that are being experimented with and adopted by the street railway men throughout the country, including the systems I have just alluded to, as yet they appear to be in an experimental state; and I apprehend that the people of Columbus, when they have a system other than that which they have at the present time, and which in itself has been a great developer in the progress of the city, will feel that the horse car men, who have operated under the adverse circumstances that all street railroad companies have operated under, for years, have done all they could in the interests of their patrons, and that Columbus has received at the hands of the Street Railway company at least all that it might naturally expect, and all it was promised to receive, when they started a street car system in the streets of Columbus, as well as they have elsewhere [applause] and at the proper time, no street car man, nor any man who has stock in street car roads can be said to be at all derelict in the duty he owes to the people who drop the nickels in the slot, but that the service will be all they can expect and all that they pay for. The principle of street railroads is to afford the best possible service, under all circumstances, whether it be by cable, by electricity, by mules, or by horses. I am generous enough to say to the people of Columbus, that I have yet to find among the fraternity, a street car man who has not been anxious, and who has not been willing at any time to adopt anything that would seem to be for the interests of the people who patronize the road [applause].

There are a number of gentlemen present who have asked me to call upon them to respond to the toast of "The Ladies." I do not know any more fitting subject for the ladies than my friend Mr. Hanna, of Cleveland, Secretary of the Association, who will now respond to the toast, "The Ladies." [Applause and a voice: "What's the matter with Hanna?"]

Mr. J. B. Hanna: Mr. President and gentlemen: While I was walking along your streets this afternoon, in company with Brother Stewart, he said that if I would allow him to tell the "parrot" story he would guarantee that I would not be called upon to speak to-



night. At the commencement of this banquet he sends forth the ultimatum very boldly that any member who is called upon and does not respond shall immediately assign their stock. I have not very much stock, but I do not want to assign what little I have just yet.

It seems to me that Brother Stewart is getting into the position alluded to by Col. Parrott, and is making war on individuals.

While I am on the floor I would like to thank our friends from Columbus for this very fine banquet which we have enjoyed this evening at their hands, and thank the supply men for standing so nobly by us to-day, and to say to them that they will always be welcome to the meetings of the Ohio State Tramway Association. [Applause.]

Toastmaster Stewart then called upon Mr. Collins to respond to the sentiment:

"Punch, brothers, punch with care,  
Punch the ticket of that 'air passengair."

Mr. Collins announced his inability to respond to the toast referred to by Mr. Stewart, as he had only been in the "punch" business about two days and concluded by relating an anecdote which came within his experience some years ago as a railway man.

Mr. Stewart then called upon Mr. N. B. Abbott, of Columbus, and introduced him as one of the pioneers in the adoption of electricity in Columbus.

Mr. Abbott said that he had only been interested in street railways a short time; that he had become interested in the West Broad Street Electric Line for the purpose, if possible, of making it an electric road. He then spoke of the benefits of the system over the old-style horse car, and related some laughable incidents of inexperienced passengers endeavoring to get on and off the electric cars.

Mr. Abbott said that when he first came to Columbus, a number of years ago, he rode up from the depot in a rickety old car, and it became necessary for him to raise his umbrella to protect himself from the rain which came through the dilapidated roof of the car.

He then spoke of the advance in real estate on the West Side, which had been principally occasioned by the laying of a stone block pavement and the extension of the electric railway system. Real estate had more than doubled on the West Side in the last six months, which to his mind was attributable to the introduction of electricity as a motive power on the West Broad Street Railway.

In closing he paid a high compliment to the shrewdness and ingenuity of the supply men, who were constantly at the heels of the street railway officials, soliciting contracts for their respective supply houses.

Mr. Desler then inquired whether a system could not be used which would not have the objectionable feature of noise which was noticed in the system used on the Glenwood & Greenlawn road.

Toastmaster Stewart then introduced Mr. E. T. Mitchell, of Columbus.

Mr. Mitchell: Gentlemen, there has been a good deal said about street railways to-day. All I can tell you now is that if you come here six months hence you will not be compelled to ride upon cars drawn by mules and broken-down horses; and I can also assure you that there will be no rattling in the cars. [Applause.]

Mr. Benton: I wish to say that I think Mr. Lewis, in the multiplicity of his employments, and in his effort to fill back orders, has neglected to put rubbers in the windows of those cars on the West Broad Street Line. [Laughter.]

Toastmaster Stewart: Chicago people are great in responding to the toast of "The Ladies." We have with us a gentleman who represents a street railway paper published in Chicago, called the STREET RAILWAY GAZETTE. I refer to Mr. E. V. Cavell, its editor, who will now favor us with a few remarks.

Mr. Cavell then addressed the banqueters as follows:

Mr. Toastmaster and gentlemen: I left my voice in Chicago when I took charge of the delegation which we brought down here with us in our private car. [Laughter.]

In responding to the toast of "The Ladies," it appears to me that it would be almost superfluous to add anything to the graceful compliment already paid them by your gallant secretary, Mr. J. B. Hanna.

In my official capacity as editor of the STREET RAILWAY GAZETTE, I am not supposed to know anything about the ladies, for they can hardly be said to come within the scope of the duties of the editor of a street railway paper, except, possibly, it be Mrs. Howe, who, I believe, was once President of the Dover Street Railway company of New Hampshire. She is the only lady we know anything about officially.

Ladies and poetry, both being sweet and beautiful, should, as indeed they do, go hand in hand together, so if it will not be trespassing too much upon your good nature, I would much prefer to respond to the sentiment indicated, in the language of our toastmaster. I do not wish to violate any confidence, but I will say that Mr. Stewart handed the following verses to me this afternoon, with the request for me to read them instead of him, on account of his innate modesty, a virtue peculiar, as we all know, to street railway men. I have had but little time to commit them to memory, but I believe they run about like this:

"The comely shank uv evenin' has dwindled into mornin'  
An' the timid light a-peepin' thru the winders gives us warnin';  
We've eaten an' we've tippled 'till the roosters air a-crowin'  
And, unless I much mistaken, it's 'bout time that we wuz goin';  
But, in order to avert the good wife's customary trimmin'  
Suppose we drink, afore we go, a bumper to the winmin'!

They more than half-suspected that we couldn't do without 'em,  
An' 'twill tickle 'em all-firedly to know we talked about 'em;  
So I, for one, acknowledge, that, with prospects kinder breezy,  
I favor what'll let me down with home folks sorter easy!  
How can we drown our sorrows when our heads keep on a-swimmin'?

It ain't no use—it must be done—let's talk about the winmin'!

No one of us but likes to spark, an' court 'em, and carress 'em,

Not one but will respond "amen" when I suggest "God bless 'em!"

Why, when the rib from Adam's side was plucked for woman's makin',  
I calkerlate the maker took about all with the takin',  
At anyrate, since Adam's time, creation's been a-hym'in'  
The virtues uv the fairer an' the better sex, the winmin'.

An' we—well, if there is a love we hold afore all others,  
It is the tender, sacred love uv sweethearts, wives an' mothers;

No matter where our lot be cast, or though all else abhor us,

How glad they air to fight an' die, yes, die if need be, for us.

Here, Mister Stewart, give an order to have glasses filled to brimmin'—

And we'll drink deep to those we love—which is to say, the winmin'.

(To Mr. Stewart.)

Well, Mr. President, oft I've heard you say how much you owe 'er—

I mean the gentle, loyal wife you left in Ashtabula;  
She's by your side, in thought, to-night, while you, to friends do honor,

And they, with single voice, exclaim, "God's blessings be upon her;"

Upon the canvas of your life, her's is the fairest lim'in,  
So rise, and drink to her you love your choice of all the winmin'.

Wait—let us all, by that dear love which all our lives rejoices,—

By those dear eyes that speak to us with love's seraphic voices,—

By those dear arms that will enfold us when we sleep forever,—

By those dear lips that kiss the lips that may give answer never—

By mem'ries lurkin' in our hearts an' all our eyes be-dimmin',

We'll drink a health to those we love an' who love us, The winmin'!

[Great applause.]

Toastmaster Stewart: I am very glad that Brother Cavell committed that so nicely; that is as good as I could have done myself [laughter].

There is one gentleman present to whom I think we ought to pay our respects to-night, for we are under obligations to him for having had our banquet here and had such an enjoyable occasion. When the four delegates to the Ohio Tramway Association convened and the question arose whether this banquet should be held by the three who were from Cleveland or by the fourth who was from Columbus, the fourth gentleman, who is present with us, voted to hold it at Columbus, and consequently we are under obligations to him for the hospitality which has been extended to us to-night. I now have the pleasure of introducing to you "General" Sheldon of Columbus [renewed laughter]. I hope "The General" will forgive me for calling him "General." I think it ought to be Judge, because he is a judge of a good location to hold a banquet. Either as "General" or as "Judge," he will have this opportunity to address us.

Mr. R. E. Sheldon of Columbus: Mr. Toastmaster, and gentlemen: I never responded to a toast in my life; I never made a speech and never expect to make one. I always felt that if I could I would give a good deal. About two or three weeks ago I made up my mind that I would get my courage up to the sticking point, and if I was ever called upon to respond I would make an effort to do so, but about that time I read in the New York Tribune where Chauncey M. Depew, the prince of after dinner speakers, had made a speech at a banquet in New York, which would defeat him for the Presidency. He had said too many pleasant things about Cleveland. So lest I might make the same mistake, I will have to ask you to excuse me [great laughter and applause].

Mr. Stewart: I did not know that "The General" was a rival in my gentle ambition to be president of this Association, but I infer that much from his closing remarks [merriment]. I can assure him, however, that it was no want of speech that defeated him, because I have every reason to believe that he labored faithfully with the delegates [continued laughter and applause].

I have on my right a gentleman who stood nobly at the cannon's mouth on a certain memorable occasion, which transpired recently in Columbus, but he comes forth to us to-night unscathed—Mr. E. K. Stewart, of the Columbus Consolidated [applause].

Mr. E. K. Stewart of Columbus: Mr. President and Gentlemen:—I have but very few words to say. They may be of some interest to my friends here in Columbus who will duly appreciate the fact when they know that the directors of the Columbus Consolidated have been discussing the past few months among themselves, the question of transfers, transferring passengers from one line to another of our street railway systems; and I pro-

pose now as the first transfer which the road will make, to transfer this speech to the second Wednesday of November, 1891, at Akron [cheers and laughter].

Toastmaster Jno. N. Stewart, in closing the banquet, said: I hope every gentleman who is here, will be present at Akron next year; we will endeavor there to edify you with a number of papers that will be prepared which I am sure will be of general interest to all.

I will also say, before closing the entertainment this evening, that we feel, as street railway men, under very many obligations to the supply men for the simple reason that they keep us posted in all the matters pertaining to the operations of our roads in every particular. Some of the supply men have felt that it was perhaps uppermost in the minds of the railway men that the supply men were tagging a little too close upon their heels, and the meetings ought to be confined entirely to street railway men, and that the supply men ought to be excommunicated. I do not think that is the sentiment of a single street railway man [applause]. A man who buys his goods depends upon a knowledge of the market, and in order that he may familiarise himself with the condition of the market, he must go to the price current, and that price current is no better represented at any of our meetings than by the supply men [more applause]; and, at least so far as I am concerned, I hope that at every one of our meetings, every institution in the country, that furnishes anything that facilitates the matter of the operation of a street railway, will be present by a representative, in order to allow the railway people to keep pace with the latest improvements offered.

I will also say that we—who are in the minority—when I say "we" I mean the three of us who are in the street railway business [laughter].

A voice: Four.

Mr. Stewart: Yes, four; I was not going to count Sheldon, because he electioneered against me. [More laughter.] "We" feel that we are highly complimented by having the street railway press with us. They have been very courteous to the street railway fraternity by being present, and I hope that at every meeting we will meet them. They have done excellent service for the street railway interests; they do excellent service for the supply men at \$40 a page. [Great laughter.]

(Referring to a side remark of Mr. Cavell's.) If there is any cut in rates don't mention it here. [Continued laughter.]

We expect after all these annual meetings, whether of the national association, the state association, or any association, that every member who is on his feet and says anything, will be roasted in the next issue of the GAZETTE, Journal, or the Builders Supplement, or the other various papers published in the interest, or the electrical, or street railway people; they never miss an opportunity to roast, so far as they are able—of course they are not very able, [laughter] because they have to prepare their papers and read them as you saw this evening, [continued laughter]; one had to read his speech and the other had to borrow a poem from me to recite [long continued laughter]. However, we feel very grateful toward them all; we have tried to make them understand the error of their ways, because we usually endeavor to be a pretty jolly, generous set of fellows, and endeavor to have our passengers appreciate all we are trying to do for them. We do not send these press men and supply men any complimentary [laughter]; we are not permitted to do so by the inter-state commerce act, [continued laughter]; but I will say for the benefit of all concerned that it is not our fault.

I hope nobody has been missed, but that all have been given an opportunity to say their little speech this evening, and again thanking you for your kind indulgence, and hoping that we will all meet at Akron next year, without any diminution in number, I will bid you "good night." [Applause.]

### The Gazette's Special.

On Tuesday evening, the 18th inst., the following named gentlemen assembled at the Dearborn street station in Chicago, and boarded the GAZETTE's private car on the Chicago & Erie R'y en route to Columbus, O., to attend the ninth annual meeting of the Ohio State Tramway Association. D. F. Morris, western manager, Milklin Bros., N. Y.; A. H. Englund, secretary Electric Merchandise Co., Chicago; Payson K. Andrews, selling agent, J. G. Brill Co., Philadelphia; C. K. Harding, president Harding Electric R'y Co., Atlantic, Ia.; R. M. Johnson, selling agent Northern Car Co., Minneapolis; W. J. Cook, vice-president McGuire Mfg. Co., Chicago; D. B. Dean, western manager "Electrical Review," New York; John N. Reynolds, proprietor Car Builder Supplement, New York; John B. O'Hara, assistant editor "Western Electrician," Chicago; W. F. Collins, western manager "Electrical Engineer," New York; S. L. K. Monroe, manager "STREET RAILWAY GAZETTE," Chicago; E. V. Cavell, editor "STREET RAILWAY GAZETTE," Chicago. Messrs A. M. Warrell and Blakeslee, of the "Erie" were at the depot to see that everything was all right, and soon after 7:30 the train pulled out.

Before very long Mr. Dean started in to amuse the company, which he did most successfully—all the way down—he was quickly followed by Mr. John Reynolds, Mr. O'Hara, Mr. Cook and



Mr. Andrews, while Messrs Englund, "Papa" Johnson, Harding and Morris, to say nothing of Messrs. Collins and Monroe, vied with each other as *raconteurs*. Late in the evening Professor George Ayers, of Alabama—engaged for "this occasion only"—regaled the delegation with a very pathetic ditty touching innocent babyhood, which drew tears from the eyes of all present.

Refreshments were served en route and the party reached Columbus promptly on time in the morning. It had been arranged for a Carrette to have met the delegates upon arrival at the depot, but as explained by Mr. Brickwood, who was there, the vehicle had been caught in a wreck while *en route* to Columbus. The party boarded a car and were soon busily engaged in breakfasting at the Neil.

On the return trip Messrs. John Reynolds and R. M. Johnson found themselves unable to be with the party; S. J. Collins, of the Meaker Mfg. Co. had to take the place of both of them. By long odds the most interesting event on the "home stretch" was a speech delivered by Mr. C. K. Harding, which, for brilliance in rhetoric and eloquence in delivery, would be hard to beat.

Coffee was served in the sections at 7 in the morning, and a number of resolutions were passed of the appreciation the delegates all had of the unfailing courtesy of the railroad officials and especially that of Mr. A. M. Warrell, of the Erie road, to whose untiring efforts much of the enjoyment of the trip was largely due.

Mr. Brickwood, with one of his Carrettes, met the party upon arrival at Chicago and very courteously carried each member to his destination.

#### Convention Notes.

D. B. Dean, of the *Electrical Review*, is a host in himself in story-telling, and makes himself liked by all with whom he comes in contact.

John B. O'Hara, associate editor of the *Western Electrician*, was the wit of the GAZETTE's special, and the Chicago delegation would have missed fully one-half of its fun had he not been one of the party.

Payson K. Andrews, of the J. G. Brill Co., proved himself to be an acrobat of no mean order—en route home from Columbus—on the GAZETTE's special.

Mr. A. H. Englund, Secretary of the Electric Merchandise Co., distinguished himself by his modesty, but his many genial qualities endeared him to all who met him.

Of Mr. John N. Reynolds—whom everybody knows—be it simply said that he kept up his end, as usual, and it was with universal regret that the delegation learned of his inability to be one of the party on the home-run.

As a master of rhetorical pyrotechnics and eloquent phraseology, it can be fairly said that Bro. C. K. Harding, of Atlantic, Ia., has no peer. His wonderful speech on the return trip from Columbus was a perfect masterpiece of a perfect orator and it is a matter of extreme regret that the GAZETTE's official stenographer was not on the car to report it verbatim for the edification of those who were unable to be of the party.

Mr. W. Foreman Collins, Chicago manager of the "Electrical Engineer" of New York, was "with us," and his unfailing courtesy and demeanor made him, at once, a universal favorite. Mr. Collins is a credit to any enterprise with which he may be connected.

The Millikin pole certainly suffered nothing at the hands of its western manager, Mr. D. Forsythe Morris, who very cleverly arranged matters for his pole to constitute a part of the decoration of the banquet board at the Columbus Club.

Vice-President W. J. Cooke, of the McGuire Mfg. Co., of Chicago, was "on deck—first—last and all the time," and the delegation was unanimous in the opinion that

"Cooke is a jolly good fellow  
And so say all of us."

Mr. F. L. Kenfield of Chicago, was there as representative of the *Street Railway Journal*, and also advertised the new paper the "Street

*Railway Review*," with which, we understand, he has become identified.

Mr. C. B. Fairchild, ably looked after the interests of the *Street Railway Journal*.

The Meaker Mfg. Co. of Chicago, was represented by Mr. S. J. Collins.

President Stewart made a splendid toastmaster and evoked roars of laughter by his brilliant repartee.

The GAZETTE extends to Col. A. D. Rogers, and Mr. Stewart, Sec. Col Consolidated Street Ry Co., and to General Sheldon, its hearty thanks for many courtesies rendered.

The inability of Mr. C. B. Hanna, of Minneapolis, to be present at the convention was very much regretted; he was detained in Pittsburg, and telegraphed his regrets.

#### Missed at the Convention.

Charles Hathaway of Cleveland, Gen Geo. B. Kerper of Cincinnati, Stanley Robinson of Cleveland, Col. Dan Coolidge of Johnstown, Pa., Henry A. Everett of Cleveland, Frank de H. Robison of Cleveland, Albert G. Clark of Dayton, John Kilgour of Cincinnati, H. M. Littell of Cincinnati, C. J. Langdon of Cleveland, et al.

#### "Another Richmond in the Field."

"Hang out our banners on the outward walls—  
The cry is 'Still they come.'"

—*Macbeth: Act 5, Scene 5.*

Presided over by the very efficient Secretary of the Chicago City Railway Company; with Mr. F. S. Kenfield, whose brilliant record in the West as representative of a prominent Eastern journal is well known, as its Business Manager; and with Mr. F. X. Cicott, late of the Mint at San Francisco' as its Editor, the *Street Railway Review*, one more candidate for public favor and patronage, will be launched "early in 1891," and take its chances for success or failure, as have other similar enterprises before it.

We look for the advent of this our proposed contemporary, and in extending it a hearty welcome to the field it proposes to occupy we do so with a conviction that its success is already assured.

METALLIC ties for street and steam roads are now being furnished in Germany, for one and three tenths cents per lb. Fittings for same, three and one-fifth cents per lb.

THE Riverside Park Railway of Sioux City, which is now being built, has adopted the Westinghouse Electric System, and the Line will be open for traffic on or about April 1, 1891. It also owns the Sioux City and Highland Park Railway, a broad gauge suburban steam railroad, which will also be equipped with the same Electric System and both operated together. The experiment of electricity as a motive power on this Line will be watched with a great deal of interest, as the Line is of regular standard railroad, constructed with regulation railroad ties, and 50 pound steel "T" rail, and it gives a chance to demonstrate the utility of electricity *versus* steam on short railroad lines.

The combined electric railway system, will be about nine miles in length, and will afford two avenues of travel to Riverside Park—Sioux City's Summer resort. The Westinghouse Company will furnish extra powerful motors, geared for a speed of twenty-five miles per hour, and capable of handling an enormous travel during the Summer months.

#### "UNITED ELECTRIC RAILWAY,"

NASHVILLE, TENN, Nov. 20, 1890.

ELECTRIC MERCHANDISE Co, 11 Adams St., CHICAGO.

Gentlemen:—We have used your rawhide Pinions and are very well satisfied with them. While the life of a Rawhide Pinion is not quite so long as a good Bronze Pinion, the saving on the Iron Gear makes them very economical. You will remember we purchased some of your pinions about 5 months ago some of which are still in service. We have to-day sent you an order for 50 additional Rawhide Pinions.

Yours truly,

(Signed) E. G. CONNETTE, Supt.

#### Souvenirs of the Buffalo Convention.

The Adams & Westlake Co. distributed a little pamphlet on "How to Heat and Ventilate Street Cars in Cold Weather," and was particularly descriptive of the calorific ventilating system of heating.

The Aluminum Brass & Bronze Co., of Bridgeport, circulated a number of aluminum dollars, and with which an immense amount of fun was had.

The Buffalo Belting Works made itself remembered by the issuance of a very neat card.

The Buffalo Street Railway Co. issued a particularly neat little book, which contained an engraving of the Iroquois hotel, a view of the Buffalo library, Niagara Falls, etc., together with the program of what was to be done at the Convention and the names of the officers for the current year. On the inside back cover was a little pocket which contained a small book of twenty tickets, good on any of the street railway lines in the city during the Convention.

Chadbourne, Hazleton & Co. issued a very clever little arrangement in imitation of its noiseless gearing, on which the center lifted up and the advertisement appeared beneath it. A silk cord ran through the smaller gear, to enable the delegates to hang the souvenir upon their coat buttons.

The Edison Co. issued quite a number of souvenirs, one a cylinder for the graphophone, which was sent to every member in the association, with the notice that if they would call at Edison headquarters the language on the cylinder would be interpreted to them.

It also issued a neat little folder regarding the Edison system; it was bound in a fancy cover, and gotten up in first class style, as, indeed, is all literature issued from that enterprising company.

The Michigan Stove Co. issued with its compliments a frog match-safe. It was very handsomely gotten up, and appears almost lifelike on one's desk.

The New York Car Wheel Works issued a circular regarding its machined car wheels.

The New York Indurated Fire Pipe Co., of New York City, through its Mr. Collingwood, distributed a number of circulars descriptive of its famous pipe.

The Short Electric Railway Co., of Ohio, issued a very handsome pamphlet descriptive of its system and apparatus.

The Standard Paint Co., which controls the P. & B. products, distributed a very neat pocket pin-cushion made from some of its waterproof building paper, with the signals of the Signal Service on one side and its own advertisement on the other.

THE STREET RAILWAY GAZETTE issued an album, entitled "Some Familiar Faces," printed on plate paper, with rough cover, upon which the title was printed in blue and silver. The volume was bound in silk cord, and contained pictures of a great many prominent members of the A. S. R. A.

The *Street Railway Journal*, of New York, with its usual enterprise, issued a daily bulletin during the Convention. The bulletin contained a synopsis of the proceedings, together with a great deal of valuable information, all of which was well appreciated by its recipients. The publication was handsomely gotten up, and its typographical appearance all that could be desired.

The Railway Department of the Thomson-Houston Co. issued a handsomely engraved invitation to the delegates to visit its reception rooms, and gave a very handsome reception on the night of the 14th inst., and its rooms were visited by about all the delegates who had arrived at the time.

The Wainwright Manufacturing Co., of Boston, distributed among the delegates a number of celluloid tablets, containing a calendar for '91, etc.

The Wheelless Electric Railway Co. distributed a very handsome catalogue of twenty-eight pages descriptive of its conduit and overhead system; the catalogue is very handsomely gotten up, and contained about a dozen well-executed illustrations.



## STREET RAILWAY NEWS.

See also "New Enterprises," "Extensions," "Elections," etc.

## ALABAMA.

**Anniston**—We understand that an electric railroad will be built here in the near future.

**Birmingham**—The Birmingham Railway and Electric Co. has executed a mortgage in favor of the Central Trust Co., of New York, for \$1,500,000

## ARKANSAS.

**Helena**—We understand that the Citizens' Street Railway, of this city, has passed into the hands of a new company, Mr. B. B. Waddell, the president, having disposed of his entire interest.

## CALIFORNIA.

**Oakland**—Col. J. W. Hartzell, acting for eastern capitalists, has applied for a street railway franchise in this city, in Alameda and in San Francisco.

**Sacramento**—The Central St. Ry. Co. is now controlled by Mr. J. H. Henry of San Jose.

## COLORADO.

**Elyria**—We understand that a project is on foot for the building of a long distance electric railway, including a viaduct across the Platte River, of over 2,000 feet in length.

**Pueblo**—The Pueblo City Ry. Co. is anxious to get its twenty-five miles of railroad in operation by the 1st of January, and work along the line is being actively pushed forward to completion.

**Telluride**—It is expected that the street railway will be in operation here before Christmas.

## DELAWARE.

**Wilmington**—Mr. Chas. D. Armour recently resigned his position as cashier of the Wilmington City Ry. Co. here, and the employees presented him with a handsome *secrétaire* and chair as a token of their kindly feelings towards him.

## ILLINOIS.

**Duquoin**—The Duquoin St. Ry. Co. has been granted a franchise for the operation of its lines for twenty years.

**Freeport**—We understand that a Bloomington syndicate has secured control of the street railways here.

**Moline**—The Moline Electric Ry. has more than doubled its traffic since electricity was adopted as a motive power.

**Quincy**—The Quincy Horse Ry. and Carrying Co. has executed a mortgage in favor of Edward J. Parker and Jas. F. Carrott for the purpose of providing for several extensions of its lines. The mortgage consists of 280 bonds of \$500 each.

## INDIANA.

**Seymore**—The application of Benjamin F. Price, of this city, for a franchise for the construction of a street railway here has been refused.

**Terre Haute**—The Terre Haute St. Ry. Co. has mortgaged its property for \$125,000 in favor of the Illinois Trust and Savings Bank, of Chicago, for the purpose of raising sufficient money to carry out the equipping of the line with electricity.

## IOWA.

**Ames**—The Ames Street Car and Electric Motor Co., recently incorporated, has gained the right of way over certain streets and will proceed at once with the construction of its line.

**Keokuk**—A satisfactory change from horse traction to the electric motor has been made.

## KANSAS.

**Wichita**—The car barn of the Electric Railway Co. here was recently destroyed by fire as well as two motor cars and two trailers. The total loss is something in the neighborhood of \$10,000, on which there was an insurance of \$200.

## KENTUCKY.

**Commonwealth**—The Rosedale Electric Railway has filed its bond of \$50,000, as the pledge of the faithful fulfillment of its contract with the city.

## MASSACHUSETTS.

**Fall River**—At the recent railway meeting of the Globe Street Railway Co., a quarterly dividend of 1½ per cent. was declared, thus making 6 per cent. for the year. The net earnings of the company was shown to be \$20,550; the amount paid in dividends \$18,000; carried to

surplus \$2,500; total surplus \$26,000; passengers carried 3,143,212; miles run 499,219.

**Salem**—The Naumkeag St. Ry. Co. has executed a mortgage on its property in favor of the Manhattan Loan & Trust Co. of New York, in the sum of \$1,000,000, to secure the issue of that equivalent in bonds.

The Essex Electric Street Railway Co. has voted to bond the road to the extent of \$100,000.

**Springfield**—The annual report of the Springfield St. Ry. Co. for the year ending Sept. 30th, shows that during this year no less than 3,694,574 passengers were carried, an increase of 412,595 over the number carried the preceding year; the number of miles traversed was 680,991 miles, being an increase of 63,000 miles from the former report.

At a meeting of the stock-holders of the road, it was decided to increase the capital stock 100 per cent, the amount of stock now amounts to \$400,000, and the increase is asked for in order that electricity may be adopted as a motive power.

## MICHIGAN.

**Bay City**—The property of the Bay City St. Ry. Co. has been purchased by local capitalists, and the over-head electric system will be adopted. A list of the officers of the new company, which will now be known as the Union St. Ry. Co., will be found under the head of elections in this issue.

The Bay City St. Ry. Co. has secured an extension of its franchise for another thirty years.

**Grand Rapids**—The Valley City St. Ry. & Cable Co., of this city, has authorized the issuance of bonds to the value of \$2,500,000, same to be used in the equipment and extension of the service of the property owned by the company.

## MINNESOTA.

**Duluth**—The Duluth St. Ry. Co. has executed a trust deed in favor of the Minneapolis Trust Company, and bonds to the value of \$2,000,000 face value may be issued.

## MISSOURI.

**St. Joseph**—At a recent meeting of the stock-holders of the Union St. Ry. Co., it was decided to increase the capital stock from \$250,000 to \$600,000, and the bonded indebtedness, which was equal to the capital stock, was also increased to \$6,000. It was also decided to incorporate the Union & Wyatt Park line under one manager; viz., that of Mr. W. T. Van Brunt.

**St. Louis**—The following returns from the street railways of this city for the third quarter of the year have been made by the different companies:

St. Louis and Suburban:

Trips, 25,687, passengers, 1,011,314.

Mound City:

Trips, 45,092, passengers, 656,683.

Jefferson Ave.:

Trips, 19,042, passengers, 465,667.

Union Depot:

Trips, 117,330, passengers, 1,997,747.

4th Street and Arsenal:

Trips, 33,672, passengers, 301,093.

People's:

Trips, 51,520, passengers, 1,330,172.

Lindel:

Trips, 103,334, passengers, 1,268,992.

## NEW YORK.

**Amsterdam**—The report of the Amsterdam St. Ry. Co., for the quarter ending Sept. 30th, shows the gross earnings to be \$13,044.29 with operating expense of \$16,074.25; with loss from operating \$3,029.

**Brooklyn**—Permission has been accorded the Long Island City & Newton R. R. Co. to change its motive power from horse to electricity.

The Williamsburg and Flatbush Ry. Co., the the Crosstown, the Green Point and Lorrimer St. Ry., and the Calvary Cemetery Ry. have now all passed into the control of the Brooklyn City Ry. Co., and will in future be operated as part of that extensive system.

**Hornellsville**—Some time ago a franchise was granted to a number of gentlemen for the construction of a street railway here, but the enterprise was never carried out; the company is ready however to build an electric road now, but the old franchise interferes with their plans.

**New York City**—The Third Ave. Railway company has increased its capital stock from \$2,000,000 to \$12,000,000, for the purpose of cabling its system.

The reports of three of the Street Railway companies here for the quarter ending Sept. 30th have been filed with the State Railway commissioners of Albany; they are as follows:

**Forty Second Street and Grand Street Ferry**.—Gross earnings, \$107,109.25; operating expenses, \$56,488.30; other income, \$576.72; fixed charges, \$12,047.57; net income, \$39,200.10. Like quarter 1889; Gross earnings, \$101,236.45; net income, \$32,260.63.

**Harlem Bridge, Morrisania and Fordham**.—Gross earnings, \$55,786.20; operating expenses, \$43,552.25; other income, \$322.50; fixed charges, \$2,780.33; net income, \$9,826.12; Like quarter 1889; Gross earnings, \$51,184.99; net income, \$8,785.34.

**Forty-Second Street, Manhattanville and St. Nicholas Avenue**.—Gross earnings, \$135,594.75; operating expenses, \$92,096.44; other income, \$575.65; fixed charges, \$20,868.57; net income, \$14,205.39. Like quarter 1889; Gross earnings, \$117,746.26; loss from operation, \$4,256.82.

**Sandy Hill**—The report of the Green Falls, Sandy Hill and Fort Edwards Street railway for the quarter ending September 30th, shows the gross earnings to be \$4,941.06, with operating expenses of \$3,405.76, increase from other sources \$139.08; fixed charges \$544.86, leaving a net increase of \$1,129.52; a decrease of something in the neighborhood of \$700 below that of the corresponding quarter in 1889.

**Schenectady**—The street railway property here has now passed into the hands of the Edison General Electric company; of course the road will be electrically equipped.

**Utica**—The capital stock of the People's Railway company has been increased from \$300,000 to \$1,000,000.

## OHIO.

**Zanesville**—The control of the street railway system here has now passed into the hands of an Akron syndicate composed of Col. A. L. Conker, F. A. Wilcox, F. A. Seiberling, A. H. Noah, F. M. Atterholt, and W. D. Chapman, for \$75,000. The line is about five miles long, but it is the intention of the company to extend it considerably to the extent of between three and four miles of new track, and to adopt the Edison system of electric traction. About nine electric cars are to be placed in operation, and the re-equipment of the line is to cost from \$100,000 to \$125,000.

(A list of the officers will be found under the head of "Elections" in this issue.)

## OREGON.

**Corvallis**—Over two miles of street railway has been built in this city during the past year.

**Jacksonville**—Some of the citizens here have donated terminal facilities to the subscription of \$25,000, with which to build and equip a motor line from between this point and Medford. Citizens of the latter city are also interested.

## PENNSYLVANIA.

**Pittsburgh**—At the recent annual meeting of the Lombard and South Street Passenger Railway Co., it was shown that passengers to the number of 7,375,044 were carried during the year; an increase of 413,610 over the preceding year; two dividends of \$2.00 per share were declared during the year, aggregating something in the neighborhood of \$90,000.

## RHODE ISLAND.

**Providence**—We are informed that the controlling interest in the Providence cable road has been transferred to the Union Railroad Co. of this city.

## TENNESSEE.

**Nashville**—The Electric Railway and Power Co. has filed a mortgage for \$125,000 in favor of the Continental Trust Co., of New York, at 6 per cent. interest.

The employees of the Electric line here have organized a mutual aid association.

**Memphis**—The Citizens' St. R. R. Co. has executed a mortgage in favor of the Union Trust Co. of St. Louis to secure the issuance of \$2,500,000 bonds; 2,500 bonds of the face value of \$1,000 each, bearing interest of 5 per cent., payable semi-annually and maturing September 1st,



1910, numbers 100 to 900 of the bonds aggregating the sum of \$900,000, are held by the Union Trust Co., but only for the purpose of taking up and cancelling the same number of bonds for a like sum issued by the Citizens' St. R. R. Co. before its consolidation with the Memphis Railway company.

## TEXAS.

**Dallas**—The Rapid Transit Railway of this city has increased its capital stock to \$300,000.

**Fort Worth**—The car house of the Electric Railway was burned to the ground on the 4th inst., with a loss of something in the neighborhood of \$4,000 partially covered by insurance.

**Houston**—The Houston City St. Ry. Co. has increased its capital stock from \$200,000 to \$400,000.

**San Antonio**—The capital stock of the West End Street Railway company has been increased to \$100,000.

**Waco**—The Waco Dummy Street Railway Co. will adopt electricity as motive power within the city limits.

## UTAH.

**Ogden**—We understand the Ogden street railway system has been sold to the Jarvis Conklin Trust Co., of Kansas City.

## WASHINGTON.

**Seattle**—The Seattle City Railway Co. succeeded in placing \$1,000,000 of its bonds with the Central Railroad Co. of New York.

## WISCONSIN.

**Madison**—A syndicate has bought up the property of the Madison City St. Ry. Co., who will equip the line with electricity.

**West Superior**—The Douglas Street Railway Co. has increased its capital stock from \$50,000 to \$100,000.

## NEW ENTERPRISES.

## ALABAMA.

**Opelika**—The Opelika and Auburn St. Ry. and dummy line company has been granted a franchise for the construction of a Street Railway system here.

## CALIFORNIA.

**Los Angeles**—Gen. H. M. Sherman and Col. O. B. Hall, both of San Francisco, are interested in a project for the construction of an electric belt railway to pass around the city.

**Oakland**—H. W. Meek has received a franchise for an electric road from this point to Haywards.

The Oakland Consolidated St. Ry. company, capitalized at \$1,000,000, has been incorporated.

**Redwood City**—A franchise for a street railway from San Francisco to Vaden Station to Behring Joost has been granted by the Board of Supervisors of San Mateo county, to W. P. Thomas and others.

**Modesks**—A franchise for a street railway has been granted to A. C. Swain, of Merced; electricity will be used.

## COLORADO.

**Denver**—Third Ave. Ry. and Electric company capitalized at \$50,000, has been incorporated for the purpose of building an electric line four miles in length, to connect with the Welton cable line; the incorporators are Geo. E. Topping, John Cook Jr., Frederick W. Standart, E. T. Loy and Frank E. Cook.

## DISTRICT OF COLUMBIA.

**Washington**—A new street railway company has been formed here and incorporated; the capital stock of the company will be \$100,000, and terms for the incorporation called for an existence of fifty years. The object of the company is to construct an electric railway on Riverside Ave. or Sprague Street. The incorporators are W. A. Lynch, W. M. Byers, Harl J. Cook, and H. E. Houghton.

## FLORIDA.

**Jacksonville**—The Electric Belt Line Ry. company, capitalized at \$75,000 has been incorporated for the purpose of building a line about six miles in length.

(A list of the directors will be found under the head of "Elections" in this issue.)

## GEORGIA.

**Albany**—This city is to have a new street railway.

**Atlanta**—A new electric street railway project

is on foot, and while the name of the company promoting the enterprise has not yet reached us, reference to our department of "Elections" in the present issue will show who the officers are.

**Dalton**—A dummy line is to be constructed from this point to Gordon Springs, a distance of about 12 miles.

**Macon**—The Home Electric Railway company has been incorporated by J. F. Heard, jr., David J. Baer, W. E. Jenkins, W. A. Doody, W. A. Lofton, A. C. Knapp, Peter Harris and Michael Doody. Capital stock \$100,000.

A company, backed with \$100,000 capital, has applied for a charter for a new electric street railway here.

## ILLINOIS.

**Alton**—The Alton Consolidated St. Ry. Co. has been granted a franchise to build and operate a system of electric street railways in this city.

**Aurora**—News reaches us from this point that the Hon. Thos. E. Hill is trying to organize a company for the purpose of connecting Prospect Park with Wheaton via street car line.

**Champaign**—We understand that an electric railway, to be operated on the Storage Battery system, will soon be built between this point and Urbana.

**Chicago**—Messrs. Alex. Clark, B. F. Hill, jr., H. P. Daly, and Jos. H. Fitch, of Evanston, have incorporated the People's North Shore St. Ry. Co. with a capital stock of \$200,000.

The Chicago Electric Transit Co., capitalized at \$12,000,000, has been incorporated in the names of Messrs. J. M. Hannahs, W. H. Powel and G. W. Standford.

**Collinsville**—Some parties here are it is said negotiating for the construction of an electric railway from this point to St. Louis.

**Irving Park**—The Chicago and Jefferson Transit Co., capitalized at \$500,000, has been incorporated for the purpose of building an electric line to connect with the city lines, extending from Clybourn Ave. Junction and Elston Ave. to Crawford Ave., tapping Irving Park at Crawford and Elston Ave.

**Kankakee**—An electric street railway will be built here in the near future.

**Waukegan**—The Waukegan City Ry. Co., capitalized at \$100,000, has been incorporated by H. J. Page, F. D. Raymond, and W. A. Starrin.

## INDIANA.

**Howell**—The question of a street railway line to Evansville is now being agitated.

**New Albany**—We understand that a street railway will shortly be constructed from this point to Silver Grove.

**Peru**—A street railway will be built here in the near future.

## IOWA.

**Ames**—A company has been formed by parties living here and in Boone, capitalized at \$20,000, to build and operate some horse railway in this vicinity.

**Knoxville**—The Knoxville Street Railway company, capitalized at \$100,000, has been incorporated.

**Sioux City**—Last month the Riverside Park Railway company of this city was incorporated with a capital stock of \$500,000 for the purpose of constructing a short line to Riverside, the motive power of which is to be electricity under the Westinghouse patents. The following named gentlemen are the incorporators: C. R. Hornick, John Hornick, Jas. F. Peavey, J. E. Booge, C. M. Swan, W. W. Byan and J. M. Lye.

## KANSAS.

**Leavenworth**—The Leavenworth Electric Street Railway company, capitalized at \$500,000, has been incorporated.

[A list of the directors will be found under the head of Elections in this issue].

## LOUISIANA.

**New Orleans**—The Ammonia Motor & Railway company, limited, capitalized at \$200,000, has been incorporated for the purpose of manufacturing and selling motors, cars and appliances in connection with patents to work and develop the same.

## MARYLAND.

**Baltimore**—The West End Park Loan and Trust company has been incorporated, capitalized at \$500,000, to build street railways, etc.

**Cumberland**—An electric street railway is to be built at this point.

## MASSACHUSETTS.

**Brockton**—The Forest Avenue Street Railway company has been incorporated with a capital stock of \$25,000.

[A list of the directors of the company will be found under the head of Elections in this issue].

**Lawrence**—The petition of the Merrimac Valley Horse R. R. Co. of this city has been granted a franchise for the operation of an electric railway from here to Andover.

**Marlborough**—The Marlborough Street Railway company has received the right to build a street railway at Westfield. The capital stock of the company is \$25,000, and the list of directors will be found under the head of Elections in this issue.

**Whitman**—The Whitman Street Railway company has been chartered to operate a line about five miles in length. The capital stock is \$40,000, and a list of the directors will be found under the head of Elections in this issue.

**Worcester**—A company, capitalized at \$250,000, has been incorporated for the purpose of constructing and operating an electric railway between this point and Spencer.

A list of the directors will be found under the head of Elections in this issue.

## MICHIGAN.

**Ann Arbor**—The Ann Arbor, Ypsilanti and Detroit Street Railway has been incorporated, capitalized at \$50,000.

**Corunna**—A franchise having been granted by the council here, and also by that of Owosso for the construction of a street car line between the two points; the line will probably be built and in operation in the immediate future.

**Eau Claire**—The Eau Claire Street Railway Light and Power company, capitalized at \$100,000, has been incorporated.

**Flint**—Haines Bros. of New York have been granted a franchise for the construction of a street railway here.

**Grand Rapids**—The Valley City Improvement company has been incorporated by Charles Fox, Percy F. Cork, Joseph C. McKee, W. H. Raignal and I. A. R. Van Dutwan. Object: Street Railway building; capital stock, \$500,000.

## MISSISSIPPI.

**Fargo**—It is highly probable that an electric railway will be built here in a very short time.

## MISSOURI.

**Hannibal**—We understand that two more electric roads are to be built here at once.

**Trenton**—A franchise has been granted to W. E. Bailey to operate an electric street railway line here.

## MONTANA.

**Helena**—Messrs. Newton W. McConnell, Robt. N. Thornburg, Edgar C. Rogers, George P. Hopkins and John B. Clayburg have incorporated the Union Electric Railway Co. with a capital stock of \$500,000.

## NEBRASKA.

**Beatrice**—The old electric railway project has been revived and it is very likely that an electric railway will be built here in the immediate future.

## NEW JERSEY.

**Mount Holly**—Local capitalists, it is reported have decided to build a street railroad.

**Olive**—It is tolerably certain that a street railway will be built here in the immediate future.

**Trenton**—The Hamilton Township Street Railway Co., capitalized at \$20,000, has been incorporated by Louis Parrine, Jr., H. W. Perrine, S. G. Wilson, J. H. Blackwell, L. T. Henndum, Ben F. Hill and W. S. Gulsck. The road is to be about two miles in length.

## NEW YORK.

**Brooklyn**—The Brooklyn City Railroad has decided to build an electric road on 2d Avenue.

**Glen Falls**—The franchise for an electric railway has been accepted by the Street Railway company.

**Watertown**—A company has been formed here for the purpose of constructing and operating an electric street railway line through the city. The road will be four miles in length to start on. Mr. C. W. Hatch of Boston, Mass., and a number of local capitalists are interested.

## NORTH CAROLINA.

**Durham**—An electric street car line will be in operation here by the 1st of January.



## OREGON.

**Astoria.**—C. E. Belling and others have been granted a franchise for the construction of an electric railway here, to run east and west on the principal streets, and out over the hill to the bay. The road when completed will be about four miles in length.

**Dayton.**—A motor line will probably be built between this point and Millville; R. T. Shurtleff is interested.

**Eugene.**—A franchise for the construction of a street railway with the privilege of using almost any desirable motive power has been granted to Messrs. Samuel Wodell & Co.

**Glencoe.**—Messrs. J. D. Hart, A. B. Monroe, and A. W. Lambert are interested in a scheme for the construction of an electric road from this point to Fairview.

**Portland.**—News reaches us from this point that Mr. Jas. M. Thompson, President of the Pacific Cable & Construction Co., has arranged to build an electric line for the Willamette Heights Railway company.

**Salem.**—We understand that a horse car line of the Salem St. Ry. Co. has been bought up by Chicago men who will convert the motive power to electricity in the immediate future.

## PENNSYLVANIA.

**Beaver Falls.**—The Central Electric St. Ry. Co. of Beaver Falls, capitalized at \$60,000, has been incorporated, and a list of the directors will be found under the head of "Elections" in this issue.

**Braddock.**—The Braddock Electric St. Ry. Co. has been incorporated and has received a franchise for a street railway.

**Irwin.**—We understand that an electric railway is to be built from this point to N. Irvin.

**Lebanon.**—A franchise has been granted to the Lebanon and Annville Ry. Co. to construct a street railway through a number of the principal streets of the town. The company is capitalized at \$100,000, all of which has been subscribed.

**Mahanoy City.**—It is highly probable that a street railway will be built at this point in the near future.

**Pittsburgh.**—The Verner St. Ry. Co. has been incorporated with a capital stock of \$6,000.

A list of the directors will be found under the head of Elections in this issue.

**Reading.**—We understand that a charter has been granted for the construction of five miles of electric road in favor of the Reading, Shillington and Molinsville Electric Ry. Co.

## SOUTH CAROLINA.

**Charleston.**—The Sumter City Ry. and Freight Co. of Sumpter has been incorporated with a capital stock of \$10,000, for the purpose of building a street railway for the transportation of freight and passengers.

## TEXAS.

**Aransas.**—The Aransas Pass Street Railway has been incorporated by D. W. Picton, William H. Pope, W. P. Pollard, H. W. Davis and Z. C. Brown, capitalized at \$25,000.

**Austin.**—The Henrietta Street Railway Co. has been incorporated.

**Henrietta.**—A franchise has been granted to a company to build a street railway here, and work will be commenced within 90 days.

A list of the officers will be found under the head of Elections in the present issue.

**San Antonio.**—This city is soon to be connected with Lake View by means of a line of electric street railway.

**Taylor.**—The Taylor Street Railway Co. has been incorporated with a capital of \$20,000 by J. A. Gano, A. L. Penn and A. T. Doke.

**Whitesborough.**—A company has been organized here for the purpose of building a street railway.

## UTAH.

**American Fork.**—We understand that a street car line will be built between this point and Lehigh in the near future.

**Ogden.**—A. S. Garretson, of Sioux City, Ia., and others have been granted a franchise for a system of electric street railways.

## VIRGINIA.

**North Danville.**—Arrangements have been made for the construction of a street car line here.

**Manchester.**—We understand that a street

railway is to be built from this point to Petersburg.

**Wytheville.**—We understand that a syndicate of northern capitalists have applied for a charter for an electric street railway here.

## WASHINGTON.

**Seattle.**—The Seattle Street Railway company has been incorporated with a capital of \$600,000.

We understand that a project is on foot for the construction of an electric railway from this point to Tacoma, a distance of forty-two miles.

The Rainier Avenue Railway company has been incorporated by S. L. Bowman and J. K. Admiston, of Seattle, and G. F. Admiston, of Spokane Falls.

**Tacoma.**—The Peninsula Electric Railway company, capitalized at \$500,000, has been incorporated by F. C. Todd of Minnesota, T. A. Abbott and A. S. Santrick of this city.

## WISCONSIN.

**Fon du Lac.**—We understand that an electric road is to be constructed, encircling the lakes known as Monona and Mendota.

**Madison.**—Messrs. E. A. Henrickson, Russell P. Dow, J. A. A. Monroe, of St. Paul; J. W. Murphy, of Portland, Me.; D. W. Strange, of Tenbroke, Me., and John Lemont and Rufus B. Smith, of this city, have purchased the property of the Madison Street Railway company, and will convert the motive power to electricity within the next sixty days. The motive power, we understand, will be supplied from the electric light station.

**Racine.**—A project is on foot for the construction of a line of electric railway between this point and Kenosha.

## EXTENSIONS.

**Baltimore, Md.**—The North Avenue Electric Railway Co. has decided to extend its line at once.

**Brockton, Mass.**—The East Side company has decided to extend its line out through Whitman, a distance of three and one-half miles, and the contract for the extension has been placed.

**Brooklyn, N. Y.**—We understand that the Brooklyn Railway company will extend its tracks on Flatbush Avenue out through Flatlands.

**Charleston, S. C.**—The Enterprise Railway company will make a number of extensions of its lines in the near future.

**Denver, Col.**—It is rumored that the University Line will be extended to Oakesdale.

The South Broadway Electric Street Railway will be extended for a distance of about a mile.

The East Colfax Electric company has let the contract for the extension of its road to Porta, Raymond & Co.

**Eau Claire, Wis.**—The Eau Claire Electric Street Railway company will probably extend its line out to Chippawa Falls, a distance of about twelve miles.

**Gainesville, Tex.**—The Gainesville Street Railway lines are to be extended for a distance of about four miles.

**Knoxville, Tenn.**—The Knoxville Street Railway company will extend its road for three or four miles at once.

**Lynn, Mass.**—The Belt Line Railway company will extend its tracks in the near future.

**McKeesport, Pa.**—The McKeesport Passenger Railway company will at once extend its line.

**Madison, Wis.**—The Madison City Street Railway will extend its road around Lake Mendota, directly electricity has been adopted.

**Norfolk, Va.**—It is rumored that the Norfolk Street Railway company will extend its lines in the near future.

**Oakland, Cal.**—The Oakland & Berkeley Rapid Transit company has decided to extend its road out to Lorin.

**Palatka, Fla.**—The street car line here is to be extended.

**Philadelphia, Pa.**—The Peoples Passenger Railway company is extending its tracks in Germantown.

The Union Passenger Railway company has received permission to extend its tracks in various directions.

**Reading, Pa.**—The East Reading Railway is

to be extended to Stony Creek, a distance of about four miles.

**Rochester, N. Y.**—The South Avenue line of the Rochester Street Railway company will be extended.

**Rockford, Ill.**—The City Railway company will extend its tracks in the immediate future.

**Rome, Ga.**—The Rome Street Railway company will probably be extended at once.

**Salem, Mass.**—The street railway here is to be extended considerably in the near future.

**San Francisco, Cal.**—The Market Street Cable Road will extend its line in the near future.

The McAllister Street will be extended for about ten blocks.

**Sioux City, Ia.**—The Sioux City Railway company has extended its line out to the Nebraska end of the Pontoon Bridge.

**Springfield, O.**—The City Street Railway company, it is reported, contemplates the extension of its tracks.

**Topeka, Kans.**—The Electric line here will probably be extended out to Highland Park over the tracks of the East Side Street Railway in the near future.

**Troy, N. Y.**—The Troy and Albia Horse Railroad it is reported will extend its lines in the near future.

**Weatherford, Tex.**—The Street Railway here is being extended.

**West Chester, Pa.**—It is stated that the West Chester Street Railway company contemplates extending its line.

## ELECTIONS.

**Ann Arbor, Mich.**—The following named gentlemen have been elected as officers and directors of the Ann Arbor & Ypsilanti Street Railway company for the ensuing year:

President—J. E. Beal.

Vice-Prest—H. P. Glover.

Sec'y—J. T. Jacobs.

Treasurer—D. L. Quirk.

Directors—Junius E. Beal, J. T. Jacobs and Charles E. Hiscock of Ann Arbor; Henry P. Glover, Daniel L. Quirk and Prof. Watling of Ypsilanti; and Albert P. Haines of New York.

**Alton, Ill.**—The stockholders of the Alton Electric Street Railway company have elected the following named gentlemen to serve on the Board of Directors for the ensuing year: C. H. Holmes, W. W. Rogers and Joseph Morrison.

**Atlanta, Ga.**—The officers of the recently incorporated Electric Street Railway company of this city are as follows:

President—B. F. Abbott.

Vice-Prest.—J. A. Mountain.

Sec'y and Treas.—H. L. Woodward.

**Bay City, Mich.**—The following officers have been elected for the ensuing year, of the West Bay City Electric Street Railway company:

President—S. O. Fisher.

Vice-Prest.—T. F. Shepard.

Sec'y—W. E. Magill.

Treasurer—H. H. Worrington.

**Beaver Falls, Pa.**—The directors of the Central Electric Street Railway company of this city, recently incorporated, are J. C. Whitlack, A. J. Jelly, Ammond R. Leyda, John A. Elliott, of Beaver Falls, and Stephen P. Stone, of Bridgeport.

**Boston, Mass.**—At the recent annual meeting of the Massachusetts Street Railway Ass'n, the following named gentlemen were duly elected as officers for the ensuing year.

President—Charles B. Pratt.

Vice-Prests.—Henry M. Whitney, Amos F. Breed, Frank S. Stevens.

Sec'y and Treas.—James H. Eaton.

Executive Committee—Percy Parker, H. A. Willis, A. E. Smith, Joseph Tucker, W. W. Cross, S. C. Hart, F. H. Knowles, John Q. Adams, E. P. Shaw.

**Bridgeport, Conn.**—The Board of Directors of the Bridgeport Horse Railroad company now consists of the following named gentlemen: Frederick Hurd, P. T. Barnum, B. F. Lasher, C. A. Hotchkiss, Frank M. Bennham, Sherman H. Hubbard.

**Charleston, S. C.**—At the recent annual meeting of the directors of the City Railway com-



pany, the following named gentlemen were duly elected:

President—John S. Riggs.  
Sec'y and Treas.—Frank F. Whilden.  
Ass't Sec'y—Evan Edwards.

The stockholders elected the following named directors: John S. Riggs, Geo. W. Williams, Rudolph Siegling, J. L. Tobias, H. H. DeLeon, Geo. L. Puist, Andrew Simonds, John F. Ficken.

**Cincinnati, O.**—The following named gentlemen have been elected as officers and directors of the Mt. Auburn Cable Railway company for the ensuing year:

President—Henry Martin.  
Vice-Prest.—R. Wurlitzer.  
Sec'y—W. S. Irwin.

Directors—David Sinton, Henry Martin, Alfred Hill, R. Wurlitzer, Marcus Warth, R. W. Haley, W. S. Irwin, James A. Gray, A. Erkenbrecher.

**Denver, Colo.**—At the annual meeting of the Colfax Avenue Electric Railway company the following Board of Directors was duly elected for the ensuing year: A. W. Chamberlin, Milo A. Smith, C. E. Dickinson, S. M. Perry and George A. Bushnell.

**Fall River, Mass.**—At the annual meeting of the Globe Street Railway company, held on the 21st ult., the following named gentlemen were elected as directors: Frank S. Stevens, John S. Brayton, Andrew J. Borden, George H. Howes, J. A. Beauvais, Simeon B. Chase, M. G. B. Swift.

**Fort Worth, Texas**—The following named gentlemen have been elected as officers and directors of the North Side Railway company for the ensuing year:

President—J. P. Smith.  
Vice-Prest.—A. T. Byers.  
Sec'y and Treas.—Geo. B. Hendricks.

Directors—J. P. Smith, A. T. Byers, Mrs. Sarah Huffman, Wallace Hendricks and Geo. B. Hendricks.

**Framingham, Mass.**—The following named officers have been elected by the Board of Directors for the ensuing year:

President—Charles H. Emerson.  
Secretary—Franklin E. Gregory.  
Treasurer—J. R. Entwistle.

**Elgin, Ill.**—The following named gentlemen have been elected as officers and directors of the Elgin City Railway company:

President—Wm. Grote.  
Vice-Prest.—J. W. Lame.  
Secretary—A. B. Church.  
Treasurer—E. D. Waldron.

Directors—Wm. Grote, J. B. Lane, E. D. Waldron, D. B. Sherwood, John I. Beggs, R. P. Jackman and A. B. Church.

**Grand Rapids, Mich.**—Mr. H. E. Browne has been elected president of the new Grand Rapids Street Railway company.

**Haverhill, Mass.**—The following named directors and auditors were elected at the annual meeting of the Haverhill & Groveland Street Railway company:

Directors—Ira O. Sawyer, James D. White, John B. Nichols, P. C. Swett, John A. Colby, Ira A. Abbott, Wm H. Smiley.

Auditors—E. G. Frothingham, G. L. Sleeper, Edgar O. Bullock.

**Henrietta, Texas**—The following named gentlemen have been elected as officers and directors of the Henrietta Street Railway company for the ensuing year:

President—W. J. Swain.  
Vice-Prest.—W. H. Chilson.  
Secretary—F. L. Miller.  
Treasurer—C. L. Stone.

Directors—W. J. Swain, W. H. Chilson, F. L. Miller, J. E. Bomar, Dr. J. M. Butterworth and C. L. Stone.

**Jacksonville, Fla.**—The following named gentlemen have been elected to serve on the Board of Directors of the Electric Belt Line Railway company: Heth Canfield, C. D. Blauvelt, Geo. Old.

**Jamestown, N. Y.**—At the annual meeting of the Jamestown Street Railway company the following named gentlemen were duly elected as directors for the ensuing year: Robert N. Marvin, Frank E. Gifford, Orsino E. Jones, A. N. Broadhead, L. B. Warner, W. S. Cameron, S. B. Broadhead.

**Junction City, Kas.**—The following named gen-

tlemen have been elected as officers and directors of the Junction City & Fort Riley Rapid Transit Street Railway company for the ensuing year:

President—John K. Wright.  
Vice Prest.—Capt. J. R. McClure.  
Secretary—Capt. C. L. Linton.

Directors—Capt. B. Reckurd, John K. Wright, John Davidson, C. L. Linton, Mrs. J. F. Streeter and Geo. W. Knight.

**Leavenworth, Kan.**—The following named gentlemen have been elected as officers of the Leavenworth Electric Street Railway company:

President—S. F. Neely, Leavenworth.  
First Vice-Prest.—B. F. Sunny, Chicago.  
Second Vice-Prest.—H. L. Newman, St. Louis.  
Sec'y and Treas.—D. J. Haft, Kansas City.  
Chief Engineer—Wm. B. Knight, Kansas City.

**Mahanoy City, Pa.**—The stockholders of the Mahanoy City Electric Railway have elected the following Board of Directors: Charles D. Kaier, A. W. Brown, D. J. Cleary, William E. Jones, Robert Littlehales, George W. Seligman, M. J. Litsch, Guy C. Irish, W. F. Richardson, N. Huber, and M. McMullan.

**Manchester, N. H.**—The following named gentlemen have been elected as officers and directors of the Manchester Street Railway company for the ensuing year:

Prest. and Auditor—Chas. Williams.  
Treasurer—Chas. H. Bartlett.  
Clerk—Edwin F. Jones.

Directors—Chas. Williams, O. B. Olzendam, Jas. F. Briggs, Chas. H. Bartlett, Joseph L. Stevens.

**Marlborough, Mass.**—The following named gentlemen have been elected as directors of the Marlborough Street Railway company for the ensuing year: W. F. Eno, O. B. Parks, H. G. Taylor, R. B. Crane, J. H. Shepard, F. F. Van Deuzen and C. F. Yeomans.

**New York City, N. Y.**—The directors of the Broadway Railway company are as follows: Daniel S. Lamont, Thomas F. Ryan, Henry Thompson and Charles F. Frothingham, of New York City; Charles E. Warren and Daniel B. Hasbrouck, of Brooklyn; and William J. Ramsey, of Newark, N. J.

The stockholders of the proposed Fifth Avenue Railroad have elected the following named gentlemen to serve on the Board of Directors: Thomas B. Musgrave, Lewis May, William H. Lee, Edward V. Loew, Isaac B. Newcombe, A. S. Hatch and Eugene S. Goadby.

**New Bedford, Mass.**—The following named gentlemen have been elected as officers and directors of the Onset Street Railway company for the ensuing year:

President—E. G. Brown.  
Sec'y and Treas.—W. W. Currier.  
Directors—E. G. Brown, W. W. Currier, Alfred Nash, Simeon Butterfield, W. D. Crockett, Cyrus Peabody, E. Y. Johnson and Charles H. Young.

**New Brunswick, N. J.**—The following named gentlemen have been elected as officers and directors of the New Brunswick City Railway company for the ensuing year:

President—H. Conger.  
Sec'y and Treas.—W. W. Price.  
Superintendent—W. F. Price.

Directors—H. Congar, A. Lemassena, Jr., W. B. Price, C. B. Matthews, C. E. Lemassena, W. F. Price and E. Q. Keasbey.

**Philadelphia, Pa.**—The following named gentlemen have been elected as officers and directors of the Equitable Engineering & Construction company of this city:

President—J. A. McKee.  
Sec'y and Treas.—H. J. M. Cardeza.  
Manager and Chief Engineer—W. A. Stadelman.

Directors—J. A. McKee, J. L. Stadelman, L. Gilliams, F. D. LaLanne, W. A. Stadelman.

**Pittsburgh, Pa.**—The following named gentlemen constitute the Board of Directors of the Verner Street Railway company of this city:

A. M. Neeper, A. C. McCollum, W. J. Mustin of Pittsburgh; J. W. Dalzell, G. W. Henderson and James N. Hill of Allegheny City.

**Rome, N. Y.**—The following named gentlemen have been duly elected as officers and directors of the Rome City Street Railway company for the ensuing year:

President—A. Rasines.

Vice-Prest.—Chas. W. Dayton.

Sec'y and Treas.—Wm. Moores.

Directors—Antonio Rasines, Chas. W. Dayton, Wm. Moores, John McWilliam, John S. McWilliam, Joseph F. Stier, Arthur L. Meyer.

**Suffolk, Va.**—The Suffolk Street Railway company has elected the following officers and directors:

President—John B. Brimmer.  
Vice-Prest.—A. L. Eley.  
Secretary—Lee Britt.

Treasurer—Wm. F. Jones, Jr.

Directors—The officers and Frank D. Gill, of Portsmouth; Joseph P. Webb, C. H. Causey, Claude Wright, George W. Murray.

**Utica, N. Y.**—The following is the list of new officers of the Peoples' Railway company here:

President—A. N. Palmer.

Treasurer—F. W. Barker.

Superintendent—Henry H. Durr.

Directors—A. M. Palmer, F. W. Barker, vice P. V. Rogers and H. J. Durr resigned.

**Walla Walla, Wash.**—The Street Railway company here has recently elected the following named gentlemen as officers and trustees:

President—W. C. Winans.

Vice-Prest.—M. C. Moore.

Secretary—H. A. Reynolds.

Treasurer—H. E. Johnson.

Superintendent—J. M. Hill.

Trustees—W. P. Winans, M. C. Moore, W. M. Kirkman, Max Baumeister, G. M. Hill.

**Whitman, Mass.**—The Whitman Street Railway company, recently chartered, has elected the following named gentlemen to serve on the Board of Directors for the ensuing year: George O. Jenkins, Frank C. Hayward, George E. Hershey, Albert Davis, Joseph O. Burdett, Thomas H. Ellis and Charles D. Nash.

**Worcester, Mass.**—The Board of Directors of the electric railway, recently incorporated, to connect this city and Spencer by way of Leicester, are D. M. Rogers, E. L. Watson, W. F. Whitemore, Chas. N. Prouty, W. B. Ferguson, T. H. Robinson and Ex-Mayor Winslow, of Worcester.

**Zanesville, O.**—The following named gentlemen have been elected as officers of the Zanesville Street Railway company, recently purchased by the Akron Syndicate:

President—Col. A. L. Conker.

Vice-Prest.—F. M. Atterholt.

Secretary—F. A. Wilcox.

Treasurer—F. A. Seiberling.

#### Business Notes.

The Messrs. J. S. & W. S. Silver, for many years connected with Richard Vose and his car spring business, having interested themselves in other lines of railway business, no longer represent the Vose interests in any particular.

RICHARD VOSE CAR SPRING CO.

After a number of years of practical experience in all kinds of Electric Street Railway, and Motor work, we respectfully call your attention to the fact that we are prepared to construct and equip Street Railways complete, under any Electric System, using either Overhead Wires, Conduit or Storage Batteries, giving the benefit of our long experience in this kind of work.

We are also prepared to act as Consulting Engineers, to supervise the Construction of Roads, test the efficiency of Plants, etc., etc.

Parties contemplating the Electrical Equipment of Street Railways will do well to correspond with us.

THOMPSON, REED & Co.,  
32 Liberty Street,  
New York.

The RICHARD VOSE CAR SPRING CO. will hereafter conduct the business relative to my "Graduated" Springs for Horse, Cable, Electric Motor and Steam Railroad Cars, which has for so many years been conducted under my name.

My authorized representatives connected with said company are John C. N. Guibert (Secretary), New York; Gustavus Suckow, New York; A. W. Slee, 500 American Central Building, St. Louis, Mo.; Wm. P. Williams, 717 Phenix Building, Chicago, Ills.

A continuance of your patronage is earnestly solicited.

Respectfully,  
RICHARD VOSE.

Address RICHARD VOSE CAR SPRING CO.,  
Room 57, 115 Broadway, New York.



Electric Railways in North America.

IN OPERATION OR UNDER CONTRACT NOVEMBER 1, 1890.

Table with columns: OPERATING CO., LOCATION, SYSTEM, CARS, MILES. Lists various electric railway systems across North America, including companies like Adams Electric Ry., Akron Electric Ry., and systems in cities like Chicago, St. Louis, and New York.



# The Street Railway Gazette.

(Copyrighted, 1890.)

Vol. V.

CHICAGO.

DECEMBER, 1890.

CHICAGO.

No. 12

## Combination Track and Wheel Brake.\*

The subject of illustration is a representation of a new combination track and wheel brake mechanism, and consists of a horizontal shaft, pivotally connected to a truck frame, in a position favorable to applying a brake-shoe to the track and wheel in the manner further on explained. The engraving herewith presented shows the mechanism applied to an electric car truck.

It may be slightly varied in construction to fit horse, freight or passenger cars as desired. At the center of the horizontal shaft a radial arm is attached, and is pivotally connected with the draw-bar through intermediate mechanism of a horse car, or freight car, or to any suitable brake power mechanism operated by compressed air, steam or electricity. On each end of said horizontal shaft is attached a cam, which is placed directly over a vertical sliding block which is kept in close contact therewith on its lower surface by means of spiral springs, which automatically remove the brake shoes from the track and wheel, when the brake power is removed, and the car is again forced forward. On the outer or inner side elevation of the vertical sliding block is pivotally attached one end of a link with turn-buckle thereon, and which link is connected at its opposite end to the wheel brake shoe, and it must be seen that as the cam shaft is rocked by means of the reversal of the draw-bar, by which the vehicle is drawn; a hand-crank through intermediate mechanism with the radial arm on the horizontal shaft; or link connection with an air-brake power, operated by the engineer. The sliding block is forced downward carrying with it the brake-shoe to the track rail, and simultaneously therewith operates the toggle joint mechanism, whereby the other brake-shoe is forced against the periphery of the wheel.

Duplicate horizontal shafts may be placed in position on truck-frames of freight or passenger cars, by which means four, eight or more track brakes may be applied to the rail simultaneously, and all operated by link connections with supplementary radial arms on the central horizontal shaft, operated by a hand-crank or other operating mechanism. The frictional surface presented to the track and wheel by such a brake power mechanism must affect the arrest of the

motion of the car or a train of cars very suddenly when an emergency demands, or it may be applied less forcibly at the will of the brakeman or engineer.

## Low Speed Multipolar Dynamos and Motors for Continuous Currents.

BY FRANK A. PERRET.

The many practical advantages of a lower rate of speed in dynamo electric machinery have long been recognized, yet until recently few attempts have been made to secure it. The widespread use of the electric motor has however rendered low speed a feature of great importance, in that it so greatly simplifies the application of the machine to all classes of work, in most cases obvi-

ating the generation of an electro motive force, the value of which is proportionate to the number of magnetic lines of force cut by it in a given time. Now the number of lines cut per second is dependent upon two factors (1), the total number of lines of force in the magnetic circuit, and (2), the number of times they are cut per second. As our aim is to generate a given E. M. F. at a lower speed than is usual, it is evident that the quantities in either or both of the above factors must be increased. In the case of the first we are limited by the saturation point of iron which prevents our indefinitely increasing the strength of the magnetic circuit without adding abnormally to the weight and size of the machine, and even were it possible to do this, an increased exciting current would be required, which would detract directly from the total efficiency. We turn then to the second factor and, paradoxical as it appears at first, it is here we find the solution of the problem.

How are we to cause an armature conductor to cut a given number of lines of force a greater number of times per second without increasing the speed? In the ordinary two-pole machine the armature conductor crosses the magnetic circuit and cuts all the lines of force twice during a complete revolution, viz, where they enter the armature core at one pole and where they leave it at the other. Now if we so dispose the magnetic circuit as to

cause the lines of force to enter the armature core at one point, to leave it another, to enter it again at a third point and to leave it at a fourth, it is obvious that the conductor will cut all the lines at four points in each revolution, and that it will therefore generate the same E. M. F. at one-half the original speed. If we increase the number of poles to six, we shall obtain the same effect at one third the speed, etc., etc. This then is the principle of construction by which we secure low speed.

It should be noted that we do not increase the number of lines of force in the magnetic circuit we do not add to the turns of wire in series on the armature, we do not increase the amount of either copper or iron in the entire machine but we simply cause the armature conductor to cross the magnetic circuit as often in one revolution as it ordinarily does in two or three revolutions, as the case may be. The writer wishes to em-

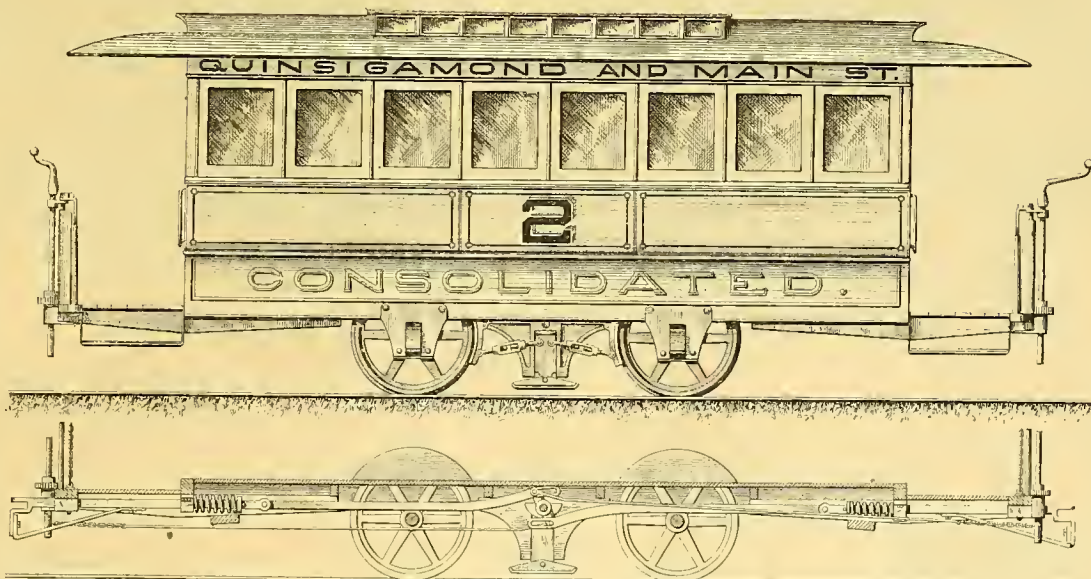

COMBINATION TRACK AND WHEEL BRAKE.

ting the necessity of countershafting or similar speed-reducing mechanism.

The writer is aware of a prevailing opinion that serious difficulties are encountered in the attempt to manufacture this class of machine on a commercial basis, but believing the difficulties to be surmountable, he devoted several years to a careful study of the subject, with the result that he designed a type of machine in which he believes the desired end is attained without the introduction of any element of danger or the sacrifice of a single feature essential to a thoroughly practical machine.

In the light of this experience it is proposed to consider briefly the principles which govern the action of multipolar machines, and to demonstrate that the obstacles which have heretofore stood in the way of low speed, may be and have been overcome.

The prime function of an armature conductor

\* R. O. Wood, Worcester, Mass.



phasize these points as there seems to be some misunderstanding in regard to them. We do not wind an armature to run slowly, but we design the machine for low speed. The resistance of our armature is no higher than that of a high speed machine of the same power, its current capacity is not reduced, in fact, as we shall see later, it is increased. The efficiency is

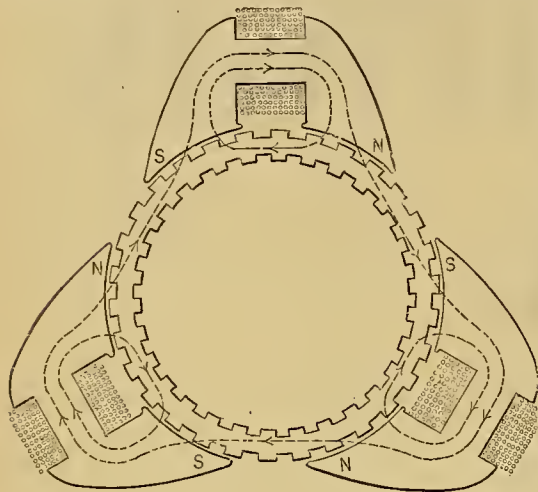

FIG. 2.—LOW SPEED MULTIPOLAR DYNAMOS AND MOTORS.

no lower, the regulation no less perfect and the weight and bulk no greater. We see then that in theory the multipolar machine is perfect, consequently if any difficulties have been encountered in its practical operation they must be due to some faults of construction, to a consideration of which the attention of the reader is now invited.

If we take as an example a motor having a six-pole field, and imagine the same in action we

the machine designed by the writer. In this construction there are but three magnets, each being isolated magnetically from the others, excepting through the medium of the armature core, and completely isolated from the framework of the machine. They are formed of plates of soft sheet iron, which are punched to the required shape and strung together on non magnetic bolts by which they are secured to their supports. A single magnetizing coil forms two salient poles, and as each magnet is built of a large number of plates a uniform magnetic conductivity is secured. By this method of construction all danger of any inequality in the strength of the poles is avoided, and a magnetic circuit without joints and of the lowest possible resistance is secured. It is understood, of course, that in all cases the number of ampere turns on each magnet must be equal.

In proportion as we decree the "feet per minute" we increase the "pounds raised" or in other words, the mechanical effort or torque is greater in a low speed than in a high speed machine, extra pains should therefore be taken to secure a substantial mechanical mounting for the armature upon the shaft, and also for the wires upon the core. The armature is therefore built up on eight insulated steel bolts, the ends of which are secured to non-magnetic spiders which in turn are keyed to the shaft. The wires are wound in longitudinal channels on the periphery of the armature core which holds the coils rigidly in place and entirely prevents that minute shifting of the wires which certainly is the cause of so many "break downs" and "burn outs" in armatures. The driving force in a motor and the resisting force in a dynamo is exerted by the armature conductors, and we should always provide a positive mechanical connection between them and the core, friction does not suffice.

The importance of this point is fully under-

total current, and the resistance is greatly reduced by reason of the increased contact surface.

In a two-pole machine the armature current is divided equally between two circuits, while that of a six-pole machine splits into six. This the writer considers in most cases an advantage, as the current carrying capacity is increased by reason of the greater surface exposed to radiation, and the machine will consequently bear a greater overload without injury, while the wire is not so large as to be unmanageable. In many machines of the two-pole type, a stranded armature conductor must be used, because a single wire would be too stiff and would heat too much; in a multipolar machine these troubles are avoided.

A great deal has been said and written in respect to the difference of potential that should be allowed to exist between adjacent commutator segments, some writers having advanced erroneous opinions on this point to the disparagement of multipolar machines.

One tells us that 10 volts should be the limit because "10 volts will just form an arc," while another puts the limit at 19 volts, and gives the same reason. Now an arc has to be started or "drawn," and the only time this can happen is when the brush connects two adjacent bars as they pass under it. But this only takes place at the so-called neutral points, where the difference of potential between adjacent bars is almost nothing. Theoretically this difference of potential is simply the product of half the total current and the resistance of the coil connected to the two bars. We see therefore that we should not take for a basis of calculation the difference of potential between adjacent bars, for the reason that the E. M. F. of each coil, is continually varying from zero to maximum, and down to zero again. A very clear description of this action will be found in the fourth chapter of S. I. Thompson's "Dynamo Electric Machinery," to

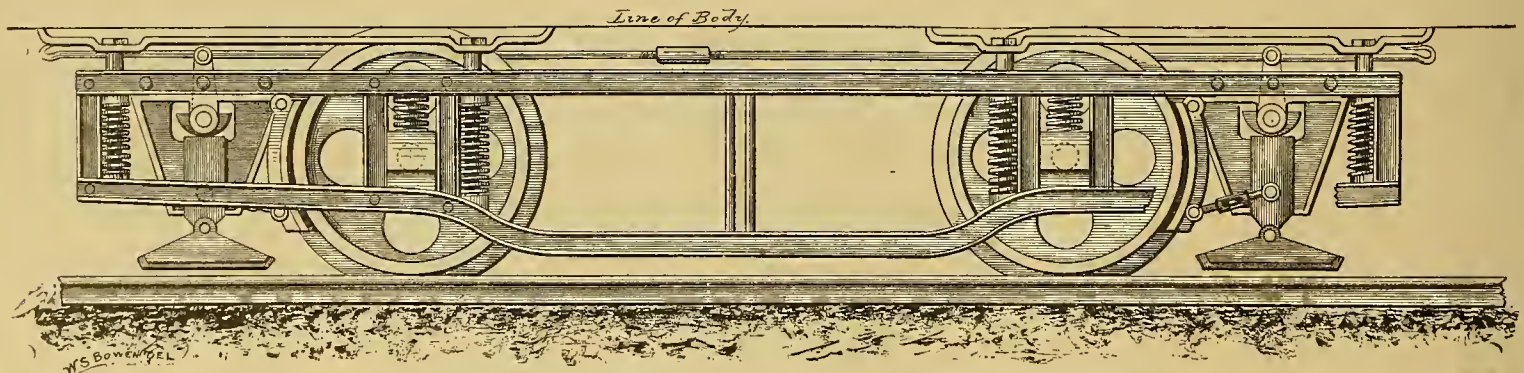

FIG. 2.—COMBINATION TRACK AND WHEEL BRAKE.

see that the distribution of potential is such as to form the equivalent of three ordinary armature windings on the one ring and connected to the commutator, which has three times as many segments as that of a two-pole machine. Each of these windings, i. e; the wire lying under one pair of poles, has exactly the same number of turns as an armature of a two-pole machine, but of a smaller wire and carries but one-third of the total current, the three acting together in multiple. This being the case, any relative difference in the strength of the field magnet poles will cause an unequal distribution of potential and current in the armature. This is, in my opinion, the most important point to be considered in the designing of such machines as any inequality is sure to cause trouble.

In a bi-polar machine there is but one path for the lines of force, which circumstance insures equal poles, but in the multipolar type, as ordinarily constructed, a variation in the magnetic conductivity of any part of the circuit will cause an inequality.

Fig. 1 represents a form commonly given to multipolar fields. It will be seen that an internal blow-hole or hard spot or other imperfection in the casting at A would choke some of the lines proceeding from B and they would therefore flow through C and cause a difference in the strength of the poles. Cast iron should therefore be excluded from the magnetic circuit, there should be no joints, and the number of magnetizing coils should be as small as possible.

Fig. 2 is a diagram of the magnetic circuit of

stood by Kapp who writes: "In many machines the friction produced by the binding-hoops is alone relied on to carry the wires through the field; but experience has shown this to be insufficient. Even if the wires are not bodily torn off the armature by the magnetic resistance of the field, they shift and work on the surface of the core; and it is only a question of time when the insulation will be destroyed and the machine break down."

We have a choice of two methods of coupling the armature circuits together in multiple, one of which is by the use of six brushes distributed around the commutator 60 degrees apart, three negative and three positive, and the other consists of a system of cross connections in the armature or commutator, which connect these coils, which are simultaneously undergoing the same induction, these in a six-pole machine are situated 120 degrees apart. By this means a single pair of brushes suffices, and these bear on the commutator at points, diametrically opposite, exactly as in a two-pole machine. This method is preferred when copper brushes are used, and I have in use a simple system of cross connections at the back of the commutator, in which all danger of short circuiting is avoided; but the carbon brush is so peculiarly adapted to the method first described, that it forms one of the simplest and most reliable means of commutation that can be devised. The high resistance of the carbon brush, as ordinarily constructed, has prevented its universal adoption, but the construction of this machine permits the use of three pairs of brushes, each pair carrying but one-third of the

gether with the methods used in determining and I commend a perusal of this to the writer referred to.

In a machine wound for 220 volts and having 22 coils, acting in series, we do not find a uniform

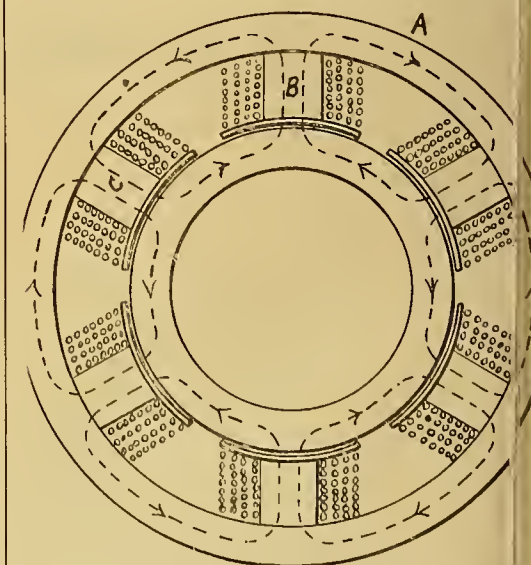

FIG. 2.—LOW SPEED MULTIPOLAR DYNAMOS AND MOTORS.

difference of potential of 10 volts between adjacent commutator bars, but those coils which are passing the poles are generating 15 or 20 volts, while those in the neutral zone are generating practically nothing. In some of the most widely



used closed coil machines in this country, the average difference of potential between adjacent segments is far greater than the limits given by the above mentioned writers. In one of these it is 27 volts, in another 50 volts, and in others it is still higher; but these machines give no trouble whatever. Let me not be understood to favor the use of a small number of commutators sections; I simply wish to show that no one is limited to 10 or to 19 volts, average potential difference between adjacent bars. In the machines of my own design, which I have partially described, the number of sections in the commutator is 96, of which 16 act in series. At an E. M. F. of 220 volts, they average therefore  $13\frac{3}{4}$  volts each, and at 500 volts total F. M. F., they will average  $31\frac{1}{4}$  volts.

As bearing upon some of the statements which I have made, I present the following details of my 10 and 20 H. P. machines, which fairly represent them all.

- 10 H. P., 225 volt Motor.  
Speed, 600 revolutions per minute,  
Weight, 900 pounds.  
Resistance of armature, .19 Ohms.  
Resistance of shunt, 175 Ohms.
- 20 H. P., 110 volt Dynamo (compound).  
Speed, 600 revolutions per minute.  
Weight, 1300 pounds.  
Resistance of armature, .029 Ohms.  
Resistance of shunt, 26 Ohms.  
Resistance of series coil, .007 Ohms.

It will be seen that a low speed multipolar machine is not necessarily a heavy one, but that on the contrary it may be made very light. The writer has recently built several 25 H. P. series wound motors, which weighed 1300 pounds each, and ran at a speed of 500 revolutions per minute. If one of these were so wound as to run at 1000 revolutions per minute, it would develop 50 H. P., and weigh only 26 pounds per H. P. For traction purposes, these motors are designed to run as slow as 450 revolutions per minute, and weigh about 70 pounds per H. P.

In regard to their practical operation, I will simply say, that the first machines which were constructed a year ago, have been in constant and satisfactory use ever since, and they have proved themselves to be in every respect, the equals of the high speed machines.

**London's Subterranean Electric Railway.**

Apropos of London's new subterranean electric railway under the river Thames, a description of the *technique* of which appeared in the November issue of the GAZETTE, and ad-

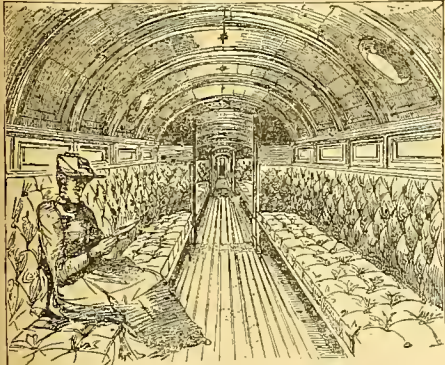

INTERIOR OF COACHES, CITY AND SOUTH LONDON RAILWAY, LONDON, ENGLAND.

ditional cuts of which, reproduced from a contemporary, we publish herein, Col. J. C. Robinson, formerly of London but now of San Francisco says in the "Chronicle."

Inasmuch as this railway or subway has now been successfully completed and seems destined to revolutionize existing methods of metropolitan railway construction and operation, a brief out-

line of the ingenious undertaking may not be inopportune. In devising this new means of transport, the ends to be kept in view were that the line should follow the thoroughfares, and

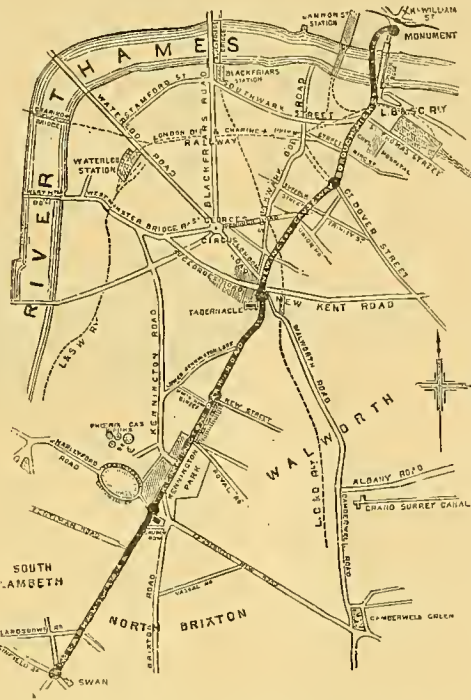

MAP OF ROUTE OF CITY AND SOUTH LONDON RAILWAY, LONDON, ENGLAND.

that it should be carried right into the center of the business activity of the city. The method of haulage and management should approximate to that of an ordinary railway, while the original cost would be less.

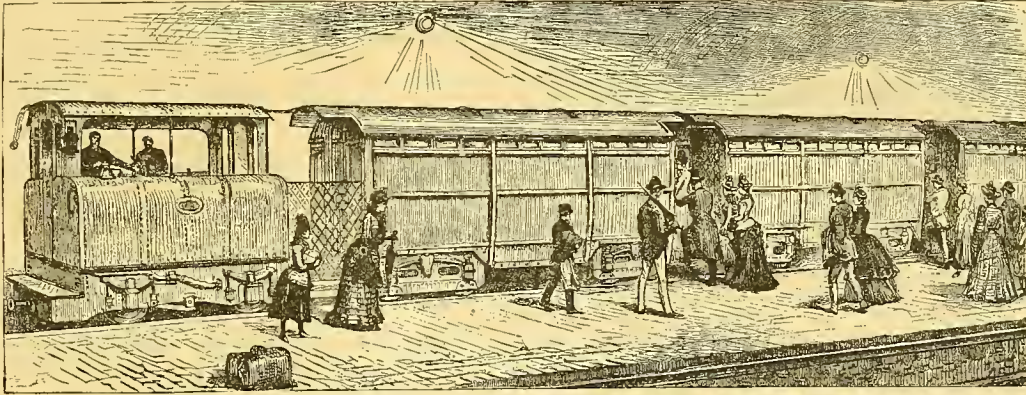

APPEARANCE OF CARS, CITY AND SOUTH LONDON RAILWAY, LONDON, ENGLAND.

The route extends from the city to the Swan at Stockwell, passing in its course, London bridge, the Borough High street, Newington causeway, Kennington Park road and Clapham road. The distance for which Parliamentary powers were obtained is three and one-sixth miles and is laid with due consideration for existing structures.

The economy of construction obtained by keeping the subway low, entailed the disadvantage of having the stations at a considerable depth below the streets. The experience of the Mersey tunnel (opened subsequently) show that passengers may be lifted by hydraulic hoists from deep stations without any difficulty and that the public learns to use them as a matter of course.

It was therefore proposed to place two elevators at each terminal point and intermediate stations, sixty feet below the street level, each capable of carrying fifty people, and that each should make its journey in about fifteen seconds. This arrangement allows egress to be obtained more quickly than from stations where the progress of the crowd is regulated by the speed at which the tickets can be collected. At Liverpool the hoists at the James street station have a lift of 76.6 feet, and at the Hamilton-street station of 87.7 feet, and each carry 100 passengers, so that the elevators on the subway will not attain the limits of experience. The pressure is obtained from pipes laid within the subway from a pumping station near the Elephant and Castle.

Each tunnel has an internal diameter of ten feet, and is formed of metallic rings in segments, bolted together by internal flanges. Each ring is 1 foot 7 inches long, and is composed of six equal segments and a short key segment with parallel ends. The flanges are  $3\frac{1}{2}$  inches deep by  $1\frac{1}{4}$  inches thick, and are bolted together by  $\frac{3}{4}$  inch bolts. The circumferential joints are made by tarred rope and cement, and the longitudinal joints by pine strips. The method of erection is almost as simple as the tunnel itself.

Supposing a short length of tunnel to be already in place in the clay, there is a steel shield consisting of a cylinder six feet long and of sufficient diameter to slide easily over the portion of the subway already bolted together. The forward end of this cylinder has a cutting edge, while about midway of its length there is a bulkhead having a door in it. Through this aperture the workmen remove a part of the clay in front, cutting out a small chamber considerably less in diameter than the shield. When this has been done the shield is forced forward by six hydraulic rams, fed by two hand pumps. The hydraulic cylinders are bolted to the shield, while the ram heads abut against the last ring of the completed tunnel. The cutting edge clears out an exact circle in the clay, forcing the material into the space prepared for its reception, from which it is dug out and removed. As the shield moves forward it leaves at its rear an annular space of about an inch between the iron and the surrounding clay, and this is immediately filled with grouting to prevent any subsidence either of the tunnel or of the ground.

The grouting, which is made of blue lias lime and water, is mixed in a wrought-iron vessel provided with paddles which can be worked from the outside. The vessel is closed and compressed air at a pressure of thirty to forty pounds per square inch is admitted to it while the paddles are kept revolving. By means of a hose pipe terminating with a nozzle, the grouting is forced through holes provided in the iron lining into the space between it and the clay until the entire cavity is filled with a shell of cement, which forms an impermeable coat round the subway and protecting it from oxidation. After the shield has been moved forward a ring of segments is bolted in, the rate of progress being

about ten feet in twenty-four hours.

One tunnel being completed from the north to the south side of the Thames the construction of the second was continued in the same manner.

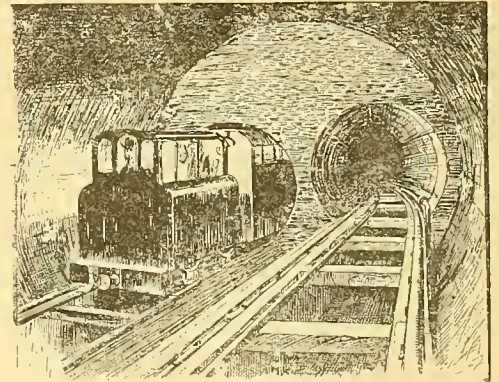

TUNNEL VIEW, CITY AND SOUTH LONDON RAILWAY, LONDON, ENGLAND.

The company has from the first disclaimed the use of steam locomotives and subsequently cable haulage in favor of electric propulsion, which is the motive power now in use and which is peculiarly well suited to a subway of this character, as it is practically independent of gradients and claims to maintain a uniform speed at all parts of the line. The trains run up one



tunnel and down the other from a central motive power station, as in cable practice.

The trains will travel in the first instance at the rate of twenty-five miles an hour and the average speed of the trains will be twenty miles per hour, including stoppages at four intermediate stations. The vehicles will resemble tramway cars, but will have more head room, while their width, which will exceed by eighteen inches that of the second-class carriages on the Metropolitan Railway, will render them very comfortable and convenient.

A train of loaded cars will weigh about twenty tons gross against 165 on the Metropolitan Railway, and of this seven tons, or 35 per cent, will be passengers, against 15 per cent. on the railway. Each carriage will have separate inlet and outlet doors, thus the train will get away very rapidly, as the motive power will not have to start from a state of rest, but will be capable of exerting a greater tractive power, in proportion to the weight of the train, than ordinary locomotives. At the terminal stations both lines converge on to a single track, and are ready to start out again without the delay which would be entailed if a locomotive had to be moved out of a siding and coupled to the train and without causing a temporary block to the service.

As there are to be no locomotives used the greatest cause of foul air will be absent, while the constant direction of the traffic in each tunnel will convert the trains into a series of pistons which will maintain an active circulation of air.

The cost of this new subway from London bridge to Stockwell is estimated at \$2,750,000,

alive to the great danger lurking in the network of wires covering so many busy streets, and no effort is spared to repair the defects as fast as they appear. With all this precaution, however, the wires are daily growing older and weaker from the incessant pounding and wear of the trolleys and the time must arrive when they will snap at points quite unsuspected, and their deadly ends may embrace many persons walking or riding beneath them. The storms and sleet of winter are also more than likely to bring these death-dealing wires down upon the heads of the

attached above the trolley wire in such a way that the strain of the branch wires attached thereto to hold it in the position shown in fig. 3 is not great enough to overcome the spring S' and allow the points to close. Should the trolley wire break, it is obvious that the weight of the falling wire would instantly close the circuit in the device, diverting the current to earth. It is practicable to use circuit closing device C, instead of D, to perform the same function, provided the same spiral spring has its tension properly adjusted and the trolley wire is free to move

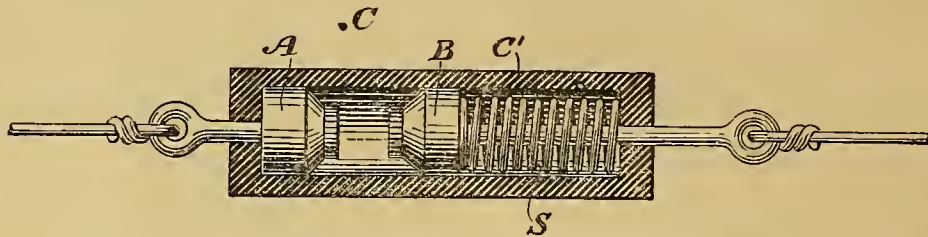

FIG. 1.—SAFETY DEVICE FOR OVERHEAD ELECTRIC CONDUCTORS.

people in the streets when the snow and rains have produced the very best conditions for fatal shocks. Electricians know that when once the danger is removed the electric pressures can be increased and with twice the voltage of current four times the work can be done. Or, the amount of copper can be reduced seventy-five per cent., thus making it possible to run the cars four times farther from the power station, or of reducing the amount of copper in the wires to one-fourth. It will be found on actual trial that the device does not wait until the wires have fallen to the

slightly in the direction of its length. As the springs are not likely to be called on for action very frequently, they can readily be rendered proof against oxidation from the weather and the determination of the proper size of the electrodes of the devices, their best construction to meet the various conditions under which they may be used, together with other details involved in their practical application will meet with a ready solution at the hands of an expert of ordinary intelligence.

In fig. 1, A and B represents the contact points of the electrodes, and in fig. 2 the corresponding points are represented by A' and B'. The cases of the device, C' and C<sup>2</sup>, and made of some insulating substance, preferably hard rubber. G, in fig. 3, represents the generator of electricity.

“Electric Railways.”

In the November issue of the GAZETTE we published in full a paper on “Electric Railways,” written by Mr. Theo. P. Bailey, and read by him before the Chicago Electric club: the paper was discussed as follows:

Mr. Kempt: Mr. Pfatischer of the Accumulator Company, New York is with us to-night, and we would be glad to hear from him.

Mr. Pfatischer: I was pleased to hear Mr. Bailey's paper, but in one particular I was disappointed. He mentioned the conduit system, but left the storage battery out of the question altogether. Now, as I am a storage battery man, I of course would like to have heard something said about it. I am perfectly satisfied that the working of street cars operated by storage batteries will assume very large dimensions in the near future. The batteries have been very much improved in the last few years, and the cost of maintenance is quite reasonable. Companies are willing to give the same guaranty that the overhead companies have done, and I think

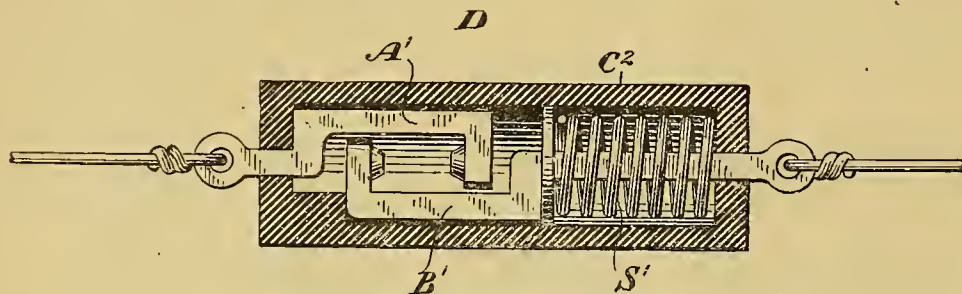

FIG. 2.—SAFETY DEVICE FOR VERHEAD ELECTRIC CONDUCTORS.

including land, buildings, stations, and rolling stock. To pay 5 per cent. on the capital there will be required, after recouping expenses, the sum of \$135,000 per annum to be raised by fares of 4 cents for any distance. A part of the route traversed by the subway is already covered with a system of tram lines, and from their published accounts we find that the average annual earnings per mile are about \$70,000. Consequently if the subway is no more successful than its competitors overhead it will take \$232,500 per annum. One need not be very sanguine, however, to believe that the underground traffic will greatly exceed that of the tramways.

ground before diverting the current of electricity, but long before the wires have reached a position of danger. Even a fall of an inch or two below their normal plane of suspension, they have been entirely deprived of their charge of the deadly fluid, and consequently are nothing more than simple uncharged wires when they arrive within reach of persons or animals, and may be handled with perfect safety by a little child.

Figures 1 and 2 shows two safety devices, C and D, applied respectively to a power wire, G W, and a trolley wire, T W, as shown in fig. 3. The grounded guard wire is not shown. Between the two insulated sections of the trolley wire and the power wire two feeder wires are

Safety Device for Overhead Electric Conductors.\*

The danger of dangling electric conductors, charged with high pressure currents, has been demonstrated so often and so seriously, that any practical invention relieving overhead conductors of their deadly menace to life should be heartily welcomed by both the proprietors of the wires and by the public. The accompanying illustrations show an ingenious safety device, designed to automatically divert the heavy currents to the earth at the points of support, should a trolley wire or a conductor of electricity for light or power be accidentally displaced, or broken. In conjunction with the device is a plan for permanently grounding the guard wire, so that any foreign wire falling across it may be reduced to zero and its dangling end be perfectly harmless, whether it was previously carrying a dangerous current or was accidentally crossed with a trolley wire. It is true that the extreme watchfulness of the companies operating the trolley street car systems may render breakages less frequent. The companies are thoroughly

seen, each including a suitable fuse, F to be blown out in case either section of T W becomes grounded

The automatic circuit closing device C (fig. 1) is attached to G W on both sides of each support (fig. 3) and the tension of spring S is overcome by the tension of the branch wires attached to G W and the support to hold the device in position, so that no current can escape from G W to earth via the device. Should G W drop slightly from its normal position the spring S will act, instantly closing the circuit via the dotted line down the pole and divert all of the current from the main conductor beyond. The automatic current opening device, D (fig. 2), is

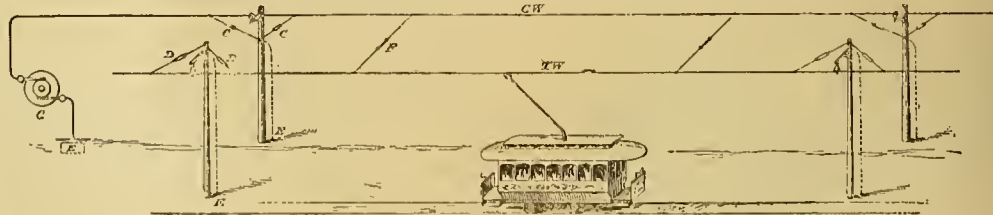

FIG. 3.—SAFETY DEVICE FOR OVERHEAD ELECTRIC CONDUCTORS.

the near future will see the equipment of many storage battery roads. Of course there are a good many of our friends in the electrical business who are rather skeptical about the storage battery, because it was not a great success some years ago, but time has changed things. As Mr. Bailey stated, the overhead system has been introduced inside of two years, and such a development is quite possible with the storage battery.

Mr. Degenhardt: Mr. Bailey touched a very tender spot when he spoke of the conduit system, as I have been working on the conduit scheme for the last two or three months in connection with some other gentlemen. I should

\* F. W. Jones, New York.



like to ask Mr. Bailey if he would tell us to what he believes failure is to be attributed and also, if he has no objections, to say what experiment are now being made in that direction.

Mr. Bailey: I desire to say that the reason my paper did not touch upon the subject of storage batteries is that I had had nothing whatever to do with them officially, and knew nothing about them in a practical way. I have read considerable about the progress storage battery companies are making, and I think they are entitled to a great deal of credit for their energy and persistence.

In reply to my friend Mr. Degenhardt, I will say, the failures that have attended the efforts of the experiments with the conduit system resulted principally from the lack of ability to secure proper insulation. The experiments that are now making in quite an extensive way, and referred to in my paper, are at Lynn, Mass., and are instituted by the Thomson-Houston Electric company. They are laying, I think, in the neighborhood of a mile of conduit for the purpose of making an exhaustive test embodying all their latest improvements. While they have hoped for success they are not making mention of the matter in a public way.

Prof. Barrett: I would like to ask Mr. Pfatischer if he has any figures showing the comparative expense for maintaining the accumulator and the overhead trolley system.

Mr. Pfatischer: I did not bring any figures with me, but the company is willing to guarantee the batteries I understand, for 20 per cent. of the first cost. In other words, the maintenance per car mile for the accumulators alone would be  $1\frac{1}{2}$  to 2 cents. I am satisfied that in the case of a good many roads, where there are not excessive grades, the storage battery system can be operated just as cheaply as the overhead system. The reason in the first place is that the motors work at a much lower potential, and both poles are insulated; and any electrician knows that a motor working at a low potential and having both poles insulated will not burn out as quickly as one which has one pole grounded. Of course it is only a question of comparative cost of maintenance. The coal consumption is not greater with the storage battery system, for different reasons. One of them is that the engine always works up to its full power, and consequently at its highest efficiency. Seeing is believing and I think we will see in the near future that the storage battery road can be operated just as cheaply as the overhead, where, as I say, grades are not excessive.

Mr. Bailey: I would like to ask Mr. Pfatischer this question. While it may be somewhat leading, he is at liberty to refuse to answer if he desires. There are roads scattered through the country here and there with one, two or three storage battery cars; but, there are no roads that I know of that are equipped exclusively with storage battery cars, and there are a number of places where the conditions are very favorable to that sort of a system. I would like to ask the gentleman what explanation the storage battery company or companies have for their failure to secure a more rapid introduction of that system; whether it is for the reason that the system is incomplete as yet, or whether it is the result of other conditions.

Mr. Pfatischer: The reason that there are at the present day not many roads in operation is in my opinion mainly due to the fact that the company which, I think, has the best battery, has not been exploiting in the field. You gentlemen all know that there has been a great amount of litigation in the storage battery field, whereas in the overhead system anybody can build a motor, and two strong companies took hold of it. You know well that as long as there is patent litigation companies do not care to invest a great deal of money. I think that is the principal reason, and there are a few others.

Mr. Degenhardt: I would like to inquire what standard of insulation is demanded, or what standard of insulation is obtained when the weather is absolutely dry, and everything is in perfect condition. To what degree can you stand a leak, as for instance, on a rainy, muggy day, when perforce there must be some leak over metallic surfaces?

Mr. Bailey: That is purely an engineering

question, and one that I would prefer to have answered by some of our scientific friends. Professor Badt can give you an answer to that question.

Prof. Badt: I do not know that that can be answered very easily; quite a number of things are to be considered. The construction of the electric railways as practiced by the different companies is not identical by any means. In an electric railway, for instance, without the proper return wires, as Mr. Bailey spoke of, but with a good metallic return by means of the rails, it might happen that less energy would be developed to give a certain number of horse power for the operation of the cars in rainy weather than in dry weather, for the simple reason, that in rainy weather the moisture of the earth adds to the conductivity of the rail. Thus what you might possibly lose by leakage in the overhead line, you might gain by the additional earth return in wet weather. In the practical operation of certain electric railways, when a break has occurred somewhere in the connection, and there was not time to repair it at once, it has been sometimes found that the cars would go over that break very sluggishly indeed. After they passed it on the last part of the road, they would hardly move at all. When it commenced to rain, the earth made a good return and the cars move over it as if there was no break at all. I think leakage in railway construction, if the work is done as it ought to be, does not occur to any great extent. If iron poles are used, insulators are always employed on the poles, and insulators are located between the ends of the span wire and the pole. The trolleys are insulated, and every trolley is insulated by span wires again; and as Mr. Bailey explained, the trolley wire insulator is so constructed that the inside is always dry, as in our glass insulator. I do not think the loss of energy by leakage, even in rainy weather, in a well-constructed railway line, amounts to anything to speak of. Feeder wires are used by some companies, I think by Mr. Bailey's company, and a good many cars run over the tracks, requiring the same good insulation as any current of 500 volts would require. They are put up in the usual way.

Mr. Degenhardt: The fact still remains that there is leakage. I asked a question to find out to what extent this seepage could be permitted to continue without material interference with the system. I asked the question, basing it on assumption that everything is in first-class order. I have inferred from conversation with gentlemen operating the lines that there is a material seepage at times in wet weather. Is there a point with a thoroughly insulated overhead line, where rain will interfere with the operation of the motors?

Prof. Barrett: As with the electric light system, overhead, there is leakage always.

Prof. Badt: Figure it out by electric laws.

Mr. Degenhardt: That is all right, but does not explain the matter. Mr. Bailey said the trouble with underground conduits was due to their inability to cope with the moisture. There certainly is absolute inability to keep off moisture on overhead lines entirely, and I was simply asking with a view of finding out how much of a figure the moisture cut.

Mr. Dow: I can answer that question to a certain extent, but I will have to go back to the days before electric railways to answer it, and then refer to the first electric railway. Going back before electric railways there was an incandescent lighting system upon which 500 volts were used and the leakage was quite serious. I had a sad time with the circuit. The leakage was grievous to my soul. We were never able to get a decent insulation test. Our rule for that circuit is the rule, I believe, that is applied to-day by electric railway companies. We would not pay any earthly attention to the leakage until the dynamo held up the engine, and then we stopped.

Now I will go back to the first street railway that I know anything about and that was the Baltimore and Hampden road on which a Daft motor of 250 volts was used. I was acquainted with some of the stockholders of that road. I was then in the telegraph service, but I fooled around the road a good deal, as it was of great

interest to me. That road worked out the question of rail bonds. They used only fish plates at first. The circuit became very bad—it was especially bad, because it used a third rail, an ordinary iron rail, as an outward conductor. They used two regular rails as a return. The outward rail was, from the beginning, if I remember right, fitted with bonds as is the usual practice now. The return rails were not at first fitted, but were afterward, in the summer time. They were bordered with small pieces of cable. The motor men on the road alleged, the engineer alleged, and everyone I got hold of alleged, although they never could show it by proper tests, that the road pulled a great deal easier in wet weather. I fully believe that it did. There must have been a heavy leakage, because the insulation from the central rail to the earth was a sheet of rubber packing. Notwithstanding that, I have seen those cars hurry along through a hollow, pulling a heavy load—every passenger that could hold on to them—with the track six inches deep in water, and with the bottom of the feed rail wet. As I said, there were two regular rails, and they were actually under the water, and the bottom of the feed rail was fairly in the water, and under those conditions that road still pulled and pulled well. The motor men said it was always run better in a heavy rain than in dry weather. They always ran until the generators held up the engines.

Mr. Degenhardt: I wanted to find out whether they did know anything about the amount of seepage that took place. It is apparent that they do not seem to know whether there is a leak going on or not until the engine is stopped. That is just what I wanted to get at. As Mr. Dow explains it, it is possible to run through water. Prof. Badt admitted practically that with a broken bonded rail they were able to run. He did not explain, as Mr. Dow has, that there was seepage, and that this thing was known and that they did not pay any attention to it. The thing I wanted to find out was as to how much seepage they can stand.

Mr. Dow: I have not been working on street railway work, but I have had a great deal of experience with overhead electrical wires, and for the last year and a half I have been handling high tension alternating currents. I have found that under certain conditions high insulation is a positive nuisance. In certain states of the atmosphere I cannot hold a screw driver to the line without the line spitting at me. I can get a static discharge from every corner and angle, just such a discharge as I get from a belt. When that condition obtains, I switch in my ground detector and leave it in until the air gets damp again. I positively start a leak on that line.

Prof. Badt: I would like to say something concerning the remarks made by Mr. Dow. A 500 volt series incandescent system cannot very well be compared with a 500 volt railway system for sufficient reasons. I had the pleasure, if I may call it so, of putting up these 500 volt systems myself, and I believe I was the pioneer in putting them up, with the alternating system, and I know just exactly what they are. There we have a multiplicity of small wires running into houses and everywhere cleated. The two wires were covered with the famous underwriters' insulation. In going into houses holes were bored downward from the outside so that the water could flow easily through the beautiful construction. Miles and miles of small wires were exposed in that manner. In street railway work we generally have one wire well insulated not by one insulator, but by a series of insulators against leakage, all in plain view. If anything happens to that insulation we can see it in a minute and find the place to be repaired. And as to static effects, I am confident enough to say I do not believe we will experience any real difficulty in the system spoken of, simply for the reason that we discharge through our motors to the ground.

Mr. Degenhardt seemed to think because I could not tell exactly what insulation we wanted, in an overhead railway system, we did not care at all how much of the expensive current escaped to earth. But I wish to state that overhead systems of electric railways are put up so well that we do not trouble ourselves to find out how well because we know it is well enough.



Because we know that so little current escapes, we do not care how much. There is a trolley wire insulated, and the trolley wire insulator suspended by an insulated wire again to cast iron poles.

Mr. Dow: The whole thing soaking wet, professor?

Prof. Badt: Supposing it is, it is only a small leakage; 500 volts is not a very high current. Supposing it is very wet weather and the insulation on such a line goes down to 500 ohms; it certainly will not go below that; as the current is equal to the electromotive force divided by resistance, there is one ampere lost in a 500 volt system. Take a big railway system using 500-horse power, the loss is nothing to be talked about as a factor.

Mr. Degenhardt: I am glad to hear the professor stir this thing up. He has certainly reached the halcyon days we are all looking for; he has a perfected state of insulation, and I am glad we have met him to-night in this controversy. He is the first gentleman I have ever met who has had the temerity to stand up and openly say that he has reached the perfection of the art.

Mr. Grier: I have observed several railways, and in regard to this question of insulation, which Mr. Degenhardt has brought up, I remember a system in Allegheny where the resistance probably got down very low. That is an underground system, and we would have water running in the conduit and the place spitting fire in the winter time. Prof. Badt spoke about the small leakage; if we have a 500-horse power engine we would have about one-fifth of one per cent. or one horse power, and really the leak doesn't have any effect until we get pretty near a dead short circuit. Then we must stop; that is all.

I think Mr. Degenhardt's idea is to ascertain what insulation resistance they would like to have between the return wire of an underground conduit, and the wire that comes to the motor; or what loss of insulation resistance would be safe in the case of an underground system if all the connections to the motors were open. I should say if we have a 500 volt system, even if we get as low down as 500 ohms, safety to life and machinery would be perfectly assured.

The Chairman: Will Mr. Day, of England, say something on this question?

Mr. Day: From what I have learned since I have been in the city, and from what I learn from reports in Europe, there is no doubt in my mind that we are upon the eve of a great modification in the storage battery, by which the dead weight carried will be very much reduced. I do not look upon the present system of the electric railway as permanent by any means. It is quite certain that a system must be developed by which we can serve the traffic of our streets, and travel all over the world. I do not think any city I have ever been in shows such congestion of the streets at certain hours of the day, as this city, and there is no doubt in my mind that all railways must be removed from the streets, for many reasons. It is my conviction that so long as pedestrian traffic is maintained, so long as the ordinary traffic by horses is maintained, there can be no very great speed made by any railway system in the streets on the surface.

I am convinced, as I said before, that however excellent any of the great systems may be they are not of a permanent type. They must give place to something better. The spur gearing which is used must be discarded. The speed of the armature must be reduced, and the system must be made as noiseless as possible, and other alterations have to be introduced.

Prof. Badt: I would like to say something in addition in reply to Mr. Degenhardt. We will assume a railway system a mile in length. I can imagine a case where 100 electric horse power will be transmitted over the wire. What have we in such a system? A single wire one mile long transmitting 100 electrical horse power. Take an incandescent system or an arc light system and transmit 100 electrical horse power and you haven't one wire a mile long, but you have wires about twenty-five miles long over which this power is transmitted. What does that mean? It means twenty-five times or fifty times, whatever the ratio may be, as many points

where poor insulation will permit an escape. That is the reason why insulation that may be absolutely worthless for incandescent work will stand excellently for a feeder, for a trolley wire for instance, and the insulation on the trolley line, the insulation of the poles and so on, will be sufficient. It is the old question which came up, about, I think two or three years ago, when a committee was appointed by the club to prepare rules for proper insulation. Well, we came to the conclusion that it all depended, first, upon the voltage; secondly, upon the number of miles of wire. If we assume 100,000 ohms as a perfect insulation for 100 incandescent lamps, we should be satisfied with one-tenth that, or 10,000 ohms, for 1,000 incandescent lamps, and with 100 ohms insulation resistance for 10,000 incandescent lamps. So in electric railways it still depends upon the length of the line. As I said before, there are only a few points of support. There is insulation simply at these points; where these are very few in number there is very little leakage, in spite of the fact that the voltage is twice what it usually is in a city system of incandescent lighting.

Mr. Brown: One point occurred to me while listening to Mr. Bailey's very interesting and able paper, was that he did not give to the work done by electric lighting interests sufficient importance in preparing the field for electric street railways. We can imagine what would have been the result if electric railways had been suggested about ten or twelve years ago, before the electric lighting industry became general, and people became educated up to the standard that they have now reached on that subject, both as to apparatus and as to circuits.

There is a point upon which I want some information, and that is, the subject of double trolley systems, which Mr. Bailey, I believe, did not mention in his paper. I have heard that double trolley systems have been in use. I have seen affidavits by gentlemen now in the club that the double trolley systems were perfectly practicable, and I presume I could find a copy of such affidavits.

Prof. Badt: I don't know about that.

Mr. Brown: One great advantage about the double trolley system that was brought to my attention, is the avoidance of interference with the telephone lines. Now, the telephone was here before the electric street railway, and I believe that an unprejudiced man would say that our talking rights are just as valuable as our riding rights, and the telephone is entitled to consideration. Now, it is said, of course, that it is a good deal easier to put metallic circuits on telephone lines than on street railway lines. I believe that it is not certain that even putting metallic circuits on telephone lines will obviate the trouble which comes from the street railway lines, but the one way to absolutely avoid interference between the telephone current and the street railway current is to have a double trolley system, a metallic system, for your street railway lines.

Mr. Nichols: There is one point that has not been touched upon that I think should not be lost sight of, and that is the efficiency of the motor for street railway work, or in any railway work, so far as that is concerned. It is a question that has been discussed in the newspapers for some months, and there seems to be a very great difference of opinion on the subject. I think that in touching upon that part of the subject, the question of the ground return, or metallic return, could be brought in. For instance, you take it in a case of return through the track, and you notice, as we all know undoubtedly, that there is a great deal of sparking. Where that sparking occurs excessively, I have noticed it particularly on the Milwaukee line, there is undoubtedly a great production of heat from which we lose efficient work. Would not that loss which would occur in the rail occur in the double wire system? I presume that nearly every member of the club read the paper written by an electrical engineer who made a test, I think of the Daft system on the New York Elevated Railway, in which he seems to have come to the conclusion, as a result of his test, that the motor efficiency was very low. It was lower, in fact, than the efficiency of the steam locomotive. There may have been some contradictions of

this conclusion written in later papers, but I have never seen them. I think it would be very well to touch upon that subject.

Mr. Deland: There is one point that I think should be touched upon, and that is, the great faith that the early pioneers or projectors of electric railways must have had in that industry. I think there are two members of this club to whom a great deal of credit is due in this respect. They carried this matter along for, I think, two or three years, and they put in one, or possibly two or three roads. Then all at once a great company took it out of their hands. I think the gentleman who looks down upon us from that picture [W. A. Stiles] is entitled to as much credit as anybody for helping the electric railway along. I think the cities in which they have been adopted are indebted to his faith in the final outcome from the fact that he furnished the cash that was necessary for carrying out early experiments, and from which it seemed likely at the time he would get so little return.

I think the gentleman who favored us this evening with such an interesting paper is entitled to a great deal more credit than appeared on the surface.

Mr. Bliss: I am interested in one road which has a ten and one half per cent. grade, and have been interested in its operation for some time. While in the incandescent business I remember that the first plants that were sold in this city were sold at about \$40 a lamp; and the problem which is before my mind particularly in connection with electric railways, is how are we to get railroads so perfected and cheapened that the future cost will bear the same relation to the present cost as the cost of the incandescent lamps in the first place bears to the price at which they are sold now?

I am very glad to express my convictions to the club that wonderful progress has been made in this electric street railway matter; and our experience with this little road which we are operating is very encouraging for the future of this line of business. I think it has an immense future. I believe that the electric development in connection with transportation has hardly been begun, and that those who shall live a few years longer are going to see the system superseding other systems to a very considerable extent. There is operating at Topeka on one of the roads a storage battery system against which I have been very much prejudiced, but I have occasion to watch it occasionally from time to time, and I have been surprised at the efficiency with which that apparatus was doing its work, running right straight along from day to day. So its field is widening out under various conditions, and it is going to make business for us all, and I think it is going to be a very great benefit in every way.

Mr. Day: What is the average efficiency of any one system of motors used on street railways? I made a careful study of the electric railway which has been started in Indianapolis, the first railway that has got a line of poles insulated, and a double line extending across. I noticed on the starting of those cars up a hill there was a tremendous amount of sparking for which I was unprepared from all I had heard about them. I wish to find out from these gentlemen if that is their experience. What is their estimate as to the loss of sparking during the early period of commencing from a stop to getting into a fast motion.

Mr. Bailey: In reply to our friend Mr. Pearson in regard to the fatality of a current of 500 volts used in electric railways, I will give the result of an investigation that was made by a committee of the Senate and House of Representatives of Washington, and I think that perhaps will satisfy him that the current is absolutely safe. One of the companies had begun an installation of an overhead system here, and they were enjoined by property holders and citizens who alleged danger to the lives of the people. The matter was referred to a committee of the House and Senate, and a very careful and rigid examination was made. I believe something like two hundred witnesses were examined and I think about fifty affidavits were presented; and the testimony was overwhelming that the current was absolutely safe so far as fatality was concerned. The injunction



was then dissolved and the work was allowed to proceed.

In reference to the remark of Mr. Brown in regard to the double trolley system, I feel at liberty to rehearse the experience of one of the companies at Cincinnati. They took a contract to put up a double wire system, and they worked on it something like five or six months before they had it in any where near satisfactory working order. The system was very complex from the fact that it was a double track road with numerous curves and some crossings, and they seemed to be unable to put up enough supports to hold the wire in place and to provide for the heavy frogs and switches that have to be used. I think, however, that by wiping out some of the complexities and reducing it practically to a straight double track without any curves or switches, they were able to make it work with fair satisfaction.

In regard to the question of using a double wire system with reference to obviating the objections and troubles which the telephone companies complain of, I think that matter has been fully determined by the courts, to whom the telephone companies appeal for relief. I have no doubt the railway companies would be very glad to use the double trolley system if they could, and the telephone companies have tried very hard to compel them to do it. They appeared to be able, however, to demonstrate to the satisfaction of the courts that they could not build a practical and commercial railway system with double wires. Telephone companies seem now to appreciate these conditions and in some cases have adopted the McCluer system and in others are arranging, I believe, for the use of the metallic system. In regard to the distance which electric railways are operated in one direction from the central station, I beg to say that we have some roads ten miles. We have a number of roads with arms or branches six or seven miles long. As for the possible growth of the system to take the place of steam road operations I do not feel quite sanguine enough on the subject just now to predict that that will be done very soon. I do not see any very serious electrical obstacles in the way; it seems to me to be within the range of possibilities, and I think ultimately it will be done.

Regarding the sparking at the wheels, I have seen the installation at Indianapolis to which our friend alluded, and I have noticed that in certain conditions of track there is considerable sparking. I have seen the road in operation at other times when the track was clean, and there was absolutely no sparking at the wheels whatever.

### West End Street Railway Company, Boston.

PRESIDENT WHITNEY'S ADDRESS.

The annual meeting of the Stockholders of the West End Street Railway Company was held on Thursday, November 13th, when President Whitney addressed it as follows:

*Gentlemen:* The report of the company has been distributed, I presume, to all the stockholders. The work of the company during the last year has been, of course, largely in connection with its electric service. That involves almost an entire revolution in the whole system. It involves, in the first place, a much heavier and more expensive track, which is to the advantage of both the road and the community. It implies, ultimately, a different and a larger car, which the company has been experimenting with somewhat during the year, which, I presume, many of the stockholders have seen, and which the company has now decided largely to adopt. I refer to the car seating from 34 to 36 people, instead of the old fashioned car that seated only 22. The company has ordered 150 of those cars, which were to be delivered a part in October, a part in November and so on up to February. They are beginning to arrive now, and we have the promise of 50 of them in the month of November, so that, within the next three or four months, we hope to have on the streets, in place of our small cars, cars of much larger capacity, which will seat from 50 to 60 per cent. more people, which will be much more convenient, we think, to the community, and which will, of course, be an advantage to the corporation.

Our experiences with electricity during the last year has more than justified the expectations of the company and the directors, as reported to the stockholders a year ago. We find that, wherever electricity is put, in the number of passengers to be carried increases very largely, showing, to our mind, the great satisfaction that the electric service

is giving. I know of no better illustration of that than the experience of the road since Oct. 1 of this year, since the close of our last fiscal year.

And in this connection I also desire to call attention to the embarrassments with which the company is continually meeting in endeavoring to comply with the proper demands of the community, because the truth is that business of the road grows so astonishingly fast that it is almost impossible to keep pace with it, notwithstanding even the liberal provisions that we make. The running of such a number of extra cars involves a certain addition to our car houses; it involves the addition of a certain number of horses or a certain amount of additional power, equipment and all the et ceteras that go to make up transportation as heretofore existing. Our general manager was desirous of knowing what amount of accommodation he ought to provide for the business of this year, judging by that of last year. I presume almost every man would say that if you took the percentage of increase of 1888-1889 and applied it to 1889-1890, it would be a fair basis of increase, and if you put on an additional number of cars proportionate thereto, the people would be satisfied.

Well, now, what was the result? I hold in my hand a statement of the growth of the business for the 41 days from Oct. 1, the end of our fiscal year, up to the 10th day of November. I had it brought down to the latest practicable date, largely for the purpose of showing this comparison. Now, of course Mr. Monks, our general manager, is all the time studying this question of how to provide for this increased travel, and of how much there is likely to be of it. I took the month of October as a fair average month. The travel in June, July and August is very largely affected by the weather. It is sometimes abnormally large in comparison with the travel in the winter months; therefore those summer months are not safe months to use as a basis of comparison. But the month of October, when people have generally returned to the city from their summer vacations, or the month of November, have heretofore been considered to be fair average months, or a fair average season; and it has been thought that if you take the 41 days from Oct. 1 on, in undertaking to estimate what your travel would be, it would be a fair basis for computation. But during Grand Army week, for instance of course the road carried a great many more people than it ordinarily would have, and of course a comparison of that week with any other would be an unfair comparison. But in the month of October and so far in November, I am not aware of any special inducement to travel, so that it seems to me that this period of 41 days from Oct. 1 is a reasonably fair basis for the comparison of one year with another. During those 41 days of the year 1888-1889 travel increased 4 per cent., or stating it exactly, 4.28 per cent.

On the first division, on which the electric lines were started about the 1st of December last year, the travel was increased less than 1 per cent. between 1888 and 1889. I do not know of a single reason why the travel should not have increased more in that month in that year. But the large increase in travel last year was undoubtedly due in large measure to the summer business and also the electric lines. Mr. Monk felt that this fall he must provide more cars and he did so. What was our experience this year? Why, in the same 41 days, from Oct. 1 to Nov. 10, our travel increased over the whole road, 13.38 per cent. Now, of course, that seems to us entirely abnormal. It is entirely unprecedented in our whole experience, and I simply speak of this matter at this time to show what embarrassment the company has in meeting these claims upon it. The increased number of miles, the increased number of trips which were run in October of this year exceeded by 10 per cent. those of last year. It would seem as though that would be sufficient to accommodate the increased traffic.

I was curious to see where the increased travel this year came from. Now, a little more than one-half of the first division is equipped for electricity. If I remember rightly, the earnings there for the month of October were about \$70,000 by electric lines, and about \$50,000 by horse lines. Well, now, taking the lines which are now operated by the electric system but were last year operated by horses, the increase in the travel this year has been 44.18 per cent. Just within this time that I have mentioned it has increased this much, and I know of no reason why the increase should not continue. So that while we have provided what seemed to us ample facilities for those people, although we have given them more cars, more frequent trips, yet the travel has come in so rapidly that the travel over those routes that are now run by electricity and were last year run by horses, has increased over 44 per cent. the increase of travel on that whole division, by both the horse and electric lines, has been 27.37 per cent.

The same is true of Cambridge. In Cambridge we hold that the electric system has not had quite a fair chance because we are limited as to speed on Main street, and there have been certain prejudices against the line that I think time will overcome—at any rate, I hope it will. But, notwithstanding that, the increase of travel over last year has been 16 per cent. Our Brookline and Allston lines have shown a most remarkable growth. For, although the Brookline lines were started in January, 1889, nearly two years ago, and were running last year almost exactly as they are now, excepting that we are running a few more cars, the travel this year for these 41 days, in comparison with the travel of last year, has increased 73 per cent. I speak of these matters so that the stockholders may know how large and important are the questions in connection with this travel with which we have to deal.

The directors, realizing these things to some extent—I may say for myself that I am perfectly amazed at the growth of the travel, I was entirely unprepared for any such result—realizing that the increase of travel must be large, determined to build a power station which would be ample for the service. We have spent a great deal of money on this power house, but it is all very well spent; and if there is any one thing that I congratulate myself and the board about, it is that we were induced, at the

time we started upon the building of these power plants, to build them large. The great, essential thing that we want in this business is power. There seems to be absolutely no limit to the business that is to be done, provided only we have the power to move the cars. We started out to put in a large amount of power, and I believe the road has never made an expenditure so wise as the expenditure that is now being made for the power plant. We shall have installed at our central power station within a few months 10,000-horse power in boilers and engines, and we have built a chimney and provided a boiler house sufficient for double that amount of power. We shall need every bit of it, and undoubtedly need it just as soon as we can get it done. The only embarrassment which we shall have this winter in doing our business will be this want of power. We are now having power from the Cambridge Electric Light company and the Edison Electric Light company, and we would be very glad to get double the amount of power that they can give us. We have put in temporary plants, and all that sort of thing. We have gone on and invested money this year, a permanent investment, but in my judgment a very wise investment, because at this time next year, instead of being embarrassed by want of power, we shall have power enough. With the exception of a few minor details which have been corrected, the only difficulty the company has ever experienced in moving its cars has been from the want of power. I am happy to say that the company is building its power house upon a scale which will meet that difficulty and overcome it. Everything connected with the system, so far as I have any knowledge of it, more than fulfils the expectations which I have expressed and which I felt from the very beginning, at the time that we decided to put in this electric system, and I think that the electric system itself will become more and more satisfactory to the community. There are improvements in prospect, almost here, which will reduce the noise of the motors. The noise seems to be the greatest objection. But the improvements which are now being perfected, some of which I hope will materialize within a short time, will so change the gearings and other details connected with the motors as to very greatly reduce the noise.

In this connection it is proper that I should call your attention to the great growth of this business, and the great number of people that desire to travel if only they can have the opportunity. Now, given the electric system to points in Charlestown, Somerville, Malden, Melrose, and to Upham's Corner, Field's Corner, Dorchester, South Boston and everywhere else, I do not know why the experience which I have detailed should not be repeated throughout the whole system. I do not know why, if we can have quicker and better transit, the same experience in regard to increased travel should not be felt throughout the whole system that we have experienced in the portion of the line already equipped with the electric system.

But what are we going to do? The question which this board and these stockholders must consider is, what shall be done with this great increase in travel? I have no question at all that within three years from this time we shall be called upon to carry from 30 to 50 per cent. more of people than we do now. If our travel is growing over our electric systems at the rate of 10, 20, 30, 40 and 50 per cent., it seems to me absolutely certain that within three years we shall be called upon to carry from 30 to 50 per cent. more of people on the surface. What shall we do with them? That is the question. Where shall we bring them to, and where shall we leave them? Is there any more room on Washington street or Tremont street to put cars? Fifty per cent. more of people means from 175,000 to 200,000 people more a day. Anybody looking back at the past history of the travel in and out of Boston over these lines; looking at it since October 1, on these statistics which I have presented—and they are facts—everybody who will concede that the experience of the past is a fair basis for an estimate for the future, must agree that there will be carried into this city from 175,000 to 200,000 people a day more than we are now carrying. Well what are you going to do with them? It is physically impossible for any more cars to be put upon these streets between the northern depots and Boylston street; between Scollay square and Boylston street, it is physically impossible to put any more cars. And the result will be that, if some other means is not provided by which these people can be carried to and fro, stations must be established at each end of the city and people must be brought to those points and left there. We must establish depots similar to the steam car depots. This is not because we would not do otherwise, for we would be willing and glad to carry these people further, but because it is physically impossible to do it. You cannot put two cars in the space where one only can go; and that is all there is to the problem. The company must face another year the problem of carrying 30 per cent. more people over its electric lines than it did last year. Although we have more than one-fifth of our lines ready for the overhead wires and all that sort of thing, yet for the want of power, we are running only about one-fifth of our system by electricity. Now we must face this problem of what shall be done with these cars when they get down town. And the people, also, must face this question. It cannot be left for the railroad to solve. It can be solved only in one of two ways. Those two ways are these: Either the people must be content to stop in places remote from the centre of the city or else some other way must be provided to take them through.

Well, now, realizing all these facts, desiring to carry this community as far and as well as we can, desiring to give the communities we reach the best service for the least sum, we went to the Legislature last year and asked for a charter for an elevated railroad. A charter was granted, and a route has been proposed. I have given this subject a great deal of study. Every man upon the board of directors has done likewise. I do not know of any route but one upon which that road can be built. But I believe that if the city of Boston will co-operate with the road and will accept the proposition which we have made in regard to it, the road can be put upon that line and made a very



profitable investment for the stockholders. I do not know of any other route upon which the road can be built. I say that this question is one of extreme embarrassment. I look upon the solution of this problem, not as a great privilege, except in so far as it is a privilege to do my duty toward this great community and toward our stockholders. I do not regard it as a great privilege to build this elevated road, because I recognize that it is a great burden for me and for every one connected with the enterprise. But I know that it is the only possible solution of this transportation problem for the city of Boston, and I know that every man who will examine it candidly, free his mind from can't and look at the whole question, will say amen to the proposition of the West End road, because there is no other way by which this community can be so well served as by the plan which we propose. And while I am aware that it will cost a large sum of money to build this road, I know that the economies that will be introduced into the electric system and the large increase of travel that will come with these increased facilities will fully justify the stockholders in undertaking it.

I have dwelt upon these things, gentlemen, much longer than I had intended; but I hope it has not been uninteresting to the stockholders. I hope that the stockholders cordially agree with the board of directors in the view they take of this whole question. At any time the board and the officers of the company will be very glad to see any of the stockholders, and to answer any questions with reference to the condition of the road and what it is doing. [Great applause.]

**Union Street Railway—New Bedford, Massachusetts.**

The following report of the Union Street Railway company for the year ending September 30, 1890, shows a complete statement of the financial condition of that company, and is especially interesting at the present time on account of the fact that a possibility exists of the property passing into the hands of a new syndicate before long.

**CAPITAL STOCK AND DEBT.**

*Capital Stock.*

Capital stock authorized by ter.....	\$260,000 00
Capital stock authorized by vote of company.....	260,000 00
Capital stock [par value of shares \$100.].....	\$260,000 00
Number of stockholders.....	161

**DEBIT.**

Funded debt.....	\$93,000 00
Bonds due July 2, 1898, on interest at 5 per cent, unfunded debt:	
Notes payable.....	\$11,000 00
Accounts payable.....	2,945 44
Dividends unpaid.....	3,897 00
Interest accrued, not due....	1,162 50
	19,004 94

Total gross debt.....	\$112,004 94
Amount of cash assets:	
Cash.....	\$1,642 52
Supplies.....	4,524 46
Debit balances.....	246 93
	6,413 91
Net debt.....	\$105,591 03

**PERMANENT INVESTMENTS.**

*Railway,*

Track, including timber, rails, etc., laying, grading and paving.....	\$201,658 44
Interest during construction, commissions, discounts, etc.....	3,295 86
Engineering, agencies, salaries, and other expenses during construction.....	2,614 90
Electric construction.....	15,163 59
Total cost of construction.....	\$222,732 79

*Equipment.*

Horses.....	\$26,200 00
Cars, including \$5,713.01 for electric cars.....	54,551 91
Other articles of equipment, including \$222.22 for electric equipment.....	8,026 31
Total cost of equipment.....	\$88,788 22

*Land and Buildings.*

Land owned by company needed in operating road.....	47,485 82
Buildings owned by company, needed in operating road.....	24,457 80
Total cost of land and buildings.....	\$71,943 62

*Aggregate.*

Total amount of permanent investments..	\$383,454 63
Cash assets.....	6,413 91
Total property and cash assets of company	\$389,868 54

**PROPERTY ACCOUNTS, CHARGES AND CREDITS DURING THE YEAR.**

Electric construction.....	\$15,163 59
Seven new horses.....	925 00
Eight new cars, including five electric at \$5,713.01.....	8,551 91

Other equipments, including \$222.22 for electric equipment.....	376 42	\$25,043 92
Total addition to property...		
Five cars sold.....	2,000 00	
One tip cart sold.....	15 00	
Reduction in valuation of horses.....	5,232 00	
Total amount of sales and depreciation of equipment....		7,247 00

Net addition to the property for the year.....	\$17,796 92
--	-------------

**REVENUE FOR THE YEAR.**

Received from passengers... \$143,000 44	
Received from sales of manure.....	1,634 84
Total earnings.....	\$144,635 28
Income from other sources..	
Advertising.....	56 25
Rents.....	490 85
Sale of old barrels.....	25 40
Sale of old rails.....	515 68
	1,088 18

Total income from all sources.....	\$145,723 46
------------------------------------	--------------

**EXPENSES OF OPERATING FOR THE YEAR.**

Repairs of road bed and track.....	\$2,348 97
Repairs of cars and other vehicles, harness and horse-shoeing.....	10,732 51
Repairs of buildings.....	2,719 47
Renewal of horses (necessary to keep up the number in last report).....	4,256 19
Wages and salaries of president, treasurer, superintendent and their clerks.....	4,297 00
Wages and salaries of other persons employed in operating the road.....	52,806 06
Provender.....	4,503 54
Taxes, state and local.....	21,770 03
Insurance.....	1,330 36
Damages for injuries to persons and property (including unsettled claims of previous years amounting to \$5,528.49).....	6,101 56
Office and all other expenses not included above.....	5,854 80
Total expenses of operating..	\$116,702 49

**NET INCOMES, DIVIDENDS, ETC.**

Total net income above operating expenses.....	\$29,020 97
Interest accrued during year.. \$ 5,134 55	
Dividend declared (6 per cent. on \$259,800).....	15,588 42
Balance for the year or surplus.....	\$ 8,298 42
Surplus at commencement of year.....	30,746 46
Deduct:	
Acushnet Street Railway, bills paid.....	\$ 300 00
Reduction in valuation of horses.....	5,232 00
Dividend paid Oct. 1, 1889, on \$259,700 (from earnings of previous year.).....	15,582 00
Loss through insolvent debtor.....	26 38
Loss by safe robbery Oct. 11, 1888.....	43 90
	21,184 28
Add discount on old account in settlement.....	3 00
Surplus at commencement of year as charged by aforesaid entries.....	9,565 18
Total surplus Sept. 30, 1890 ..	\$17,863 60

**MILES RUN, ETC.**

Total number of miles run during the year.....	538,829
Total number of passengers carried, (including 184,890 free transfers).....	5,235 116
Total number of round trips during the year.....	119 302
Number of persons regularly employed by the company.....	109

**BALANCE SHEET.**

*Assets.*

Construction.....	\$222,732 79
Equipment.....	88,778 22
Land and buildings.....	71,943 62
Cash and cash assets.....	6,113 91
Total assets.....	\$389,868 54

*Liabilities.*

Capital stock.....	\$260,000 00
Funded debt.....	93,000 00
Unfunded debt.....	19,004 94
Surplus.....	17,863 60
Total liabilities.....	\$389,868 54

**PROFIT AND LOSS ACCOUNT.**

*Debit.*

To expenses.....	\$116,702 49
Interest.....	5,134 55
Dividends.....	15,588 00

From earnings previous year.....	15,582 00
Acushnet Street Railway bills paid.....	3 00
Loss through insolvent debtor.....	26 38
Loss by safe robbery, Oct. 11, '88.....	41 90
Reduction in valuation of horses.....	5,232 00
Balance carried forward Sept. 30, 1890 ..	17,863 60
Total.....	\$176,472 92

*Credit.*

By balance Sept. 30, 1889.....	\$ 30,746 46
Total income.....	145,723 46
Discount in settlement of old account....	3 00
Total.....	\$176,472 92

The company has 35 box cars, 37 open cars, 262 horses, 55 pairs of harnesses, three single express harnesses, seven single tow harnesses, one double team harness, three sleighs, two snow ploughs, six snow sleds, two express wagons, one heavy wagon, one buggy, one sand car and has five box cars fitted with electric motors.

The total length of track, measured as single track and expressed in miles and decimals, is 16.127; of this 15.44 is paved. Five varieties of rails are used; iron tram rails weighing 35 and 45 pounds to the yard; steel tram rails weighing 35 and 50 pounds, and a 38½ pound Johnson.

At the time this report is dated Sept. 30, three and a half miles of the old track were being equipped with an overhead single trolley electric wire, and the Thomson-Houston system was to be used.

A recapitulation of the foregoing, with a comparative statement as against the report of the previous year will prove interesting; it is as follows:

	1889.	1890.
Per mile of road run:		
Capital stock paid in.....	\$17,808 22	\$17,914 97
Net debt.....	5,130 91	7,275 62
Cost of construction.....	14,217 07	15,349 12
Per mile of road operated:		
Cost of equipment.....	5,900 33	6,117 15
Repairs of roadbed and track.....	317 62	161 85
Repairs of equipment.....	445 40	739 51
Renewal of horses.....	239 50	203 27
Gross earnings:		
Per mile road operated....	9,063 05	10,040 89
Per round trip.....	1 17	1 22
Per mile run.....	.2668	.2704
Per passenger carried.....	.0460	.0450
Expenses:		
Per mile road operated ...	7,155 62	8,041 24
Per round trip.....	93	98
Per mile run.....	.2106	.2165
Per passenger carried.....	.0363	.0361
Net income:		
Per mile operated.....	1 907 43	1,999 65
Per round trip.....	.24	.24
Per mile run.....	.0562	.0539
Per passenger carried.....	.0097	.0089
Average number of passengers per round trip.....	26	27
Percentage of expenses to earnings.....	79 p. c.	80 p. c.

**Jamestown (N. Y.) Street Railway Company.**

The report of the Jamestown Street Railway for the quarter ending September 30, 1890, as filed with the Railroad Commissions, reads as follows:

	1889.	1890.
Gross earnings from operation ..	\$5,830 61	\$7,235 66
Operating expenses.....	2,831 55	3,088 31
Net earnings from operation..	\$2,999 06	\$4,147 35
Other income.....	36 75	25 51
Gross income from all sources....	3,035 81	4,172 86
Fixed charges.....	602 05	757 02
Net income from all sources..	\$2,433 76	\$3,415 84

The general balance sheet for the quarter shows: Cash on hand, \$2,040.20; profit and loss (surplus) for the aforesaid quarter of 1890, \$3507.62.

A new emergency brake an invention of Assistant Superintendent Jenkins of the Albany City Railway company, was recently tested on one of the company's lines, and subjected to a somewhat difficult test. On the State street hill was a very heavy grade and sections of track were greased for a number of blocks, and the electric car was started over the track at a rapid headway. Upon the application of the ordinary brakes, it was noticed that the only effect it had was to check to a certain extent the revolution of the wheels, while the car continued sliding down the rail at a considerable rate of speed. Upon the application of the new brake, which was fitted to the car, the car was stopped within less than 25 feet from the time the application was made. The test was highly satisfactory, and we predict great things in the future for the device.



### The Modern Cable Railways.

will, while in a general way following established methods, be almost entirely changed in their mechanical economics. One notable exception will be the wire rope itself. A cable so perfect in its construction, as are the products of our great wire rope mills, is as near perfection as it is possible for mechanical skill to attain at the present day.

#### THE POWER HOUSE

of the modern cable railway will consist of a steel shell entirely separated from the foundations, arches and braces of the plant itself, because no building can be economically constructed to withstand the tremor incident to the movement of such ponderous machinery, and at the same time permit other occupancy.

#### THE PLANT.

The ability of the plant to develop power and transmit the same at the behest of the engineer, may not be criticised, but the modern plant will be built with wrought, instead of cast steel and iron, to a very great degree. This is notably true of the journals, and the builder will find that a wrought steel journal will have the most essential elements of strength where most is required. The assurance of the manufacturer that his goods can be implicitly relied on to give the most perfect satisfaction, is not always true; that is to say, personal interest is often found to warp the best judgments; and while his warrant would cover the cost for the replacement, it would be impossible to provide for the expenses incident to a break down.

#### DISTRIBUTION OF METAL.

There is probably not to be found so prolific a source of waste of metal as is shown in the shapes of to-day. Science has laid down such rules as, if followed, will render wastes impossible. Most of these errors of which we justly complain, are the results of pioneering, a thing of the past. Its practices are not to be tolerated. The more science, the more strength, endurance and economy. The modern cable railway builder will not enter with fear and trepidation upon the task of furnishing for his patrons, this most gigantic urban and suburban motor, when he can secure scientific and practical assistance in construction of his enterprise.

#### WHEEL PITS.

Leaving the cable, the plant and the power house, our attention is next called to the pits in which are located the ponderous sheaves which distribute and transmit the cable power. Here the modern road will demand that all shafting shall be wrought after the most approved methods used in gunnery. Our criticism will be confined to the method of restoring the traffic roadway, which is the roof of the wheel pit. The 30 in. risers must go and with them the brick arches, and in their place will be built a modern construction, having been already framed in the shops, consisting of 12 in. and 15 in. I beams, with steel plate arches, upon which a light concrete bed will support the regular granite-quartzite paving blocks firmly held in place by that most tenacious of all cements—the "selenite."

The standard street steel railway rail, weighing not less than 60 pounds per yd. (and the more the better) cannot and need not be improved on. We would gladly say as much for the shapes of curves but, by errors in alignment and the low radial figures, both the rolling stock and the passengers are subjected to unnecessary conditions. The alignment of a curve for the modern cable railway may be adjusted upon the easement system, in which case the train passes through the curve with the least amount of friction. The radius of a curve will not be subject to those conditions, which square-cornered side walks entail. These corners will, by municipal laws, be turned on a radius equal to the width of the widest intersecting walk, and the radius of the railway curve correspondingly raised.

#### RAIL JOINTS.

The modern cable railway will never have other than "suspended joints." On the contrary, the old road has sustained joints, the effect of which is, that conditions are produced utterly at variance with the laws of mechanics, which demand in rails, uniform influences, producing uniform results. The modern road will have nothing in the shape

of the so-called "fish plate," which is nothing more or less than a set of patches put on with bolts and nuts with the idle belief and hope born of expectancy but unsustainable by fact, that they, thus bolted and barred, will not submit to "loss motion," a mechanical hyperbole. In the place of these make shifts, the cable railway joints will be sustained and made continuous by wraps, having in their cross section, metal, the same in quality and quantity as is found in the rails themselves.

#### THE CHANNELS

of the modern cable railway will be built with vitrified circular slabs, dovetailed, four in number which, when set with a liquid cement, will form a harmonious unit, indestructible by any of nature's forces, and so economical as to produce in its entirety, the conduit, at a cost not exceeding 15 per cent of the wasteful Portland cement concrete so universally used under the old regime. Language can hardly convey the un-wisdom which places Portland cement in such exposed conditions, notably because it is a limestone and it drinks water like a fish.

(To be continued.)

### From the Argentine.

(Continued)

BUENOS AIRES.—Few things mark the prosperity of a nation more clearly than the constant addition to the number of miles of railway laid down throughout the country, and few things show more unmistakably the growing wealth and activity of a town than the increase in the building movement supplemented by the continual opening up of new branches of tram lines. It must be remembered at the same time that this city, or perhaps better said, the whole Republic, is passing through a very nasty financial crisis and here in the capital we hear of disturbances (political) from some of the provinces, but for all that various lines of tramways have been opened to the public service by the "Buenos Aires Grand National Tramways Company." They will very shortly be having 110 cars in movement.

Trams under the name of a company styled "La Metropolitana" (The Metropolitan) are now running.

The cars are very fine, but smaller than those used in England.

The sale of the well-known Lacroze Tramway to the Anglo-Argentine (an English company) for £500,000 has been hailed with delight by the public. The "Anglo-Argentine" has built up a reputation for good management and faultless service, also for its well-kept horses, which certainly deserves notice, for on all other lines (some 6 or 7) the horses are poorly fed and the management is bad throughout, though not from a financial point of view.

I believe now every tramway company in Buenos Aires is worked by English capital and that they have entirely the whole net of tramways (with the exception of a few private lines in the camp towns) and railways of the whole Republic in their power.

The average price given by tramway companies here for their horses is \$20, (national currency) but never exceeds that amount which is only worth \$10 of yours, or about 30 shillings in English coin.

The claims for damages against the "City of Buenos Aires" tramway company during the last few months, amounted to \$70,000, by persons injured jumping in and out. The company has been extremely lucky in getting through this litigation unscathed.

The news comes from Montevideo that a scheme for the unification of the tramways is said to be arranged with the municipality of that city and from where is reported a great strike amongst the "cocheros"—hackney coachman—owing to the city authorities trying to lower the fares, but according to later reports it is now at an end.

FRANCISCO H. N. LODIA.

We understand that the Connecticut Motor Co, sold to the Wyatt Park Electric Railway Co., of St. Joseph, Mo., for use on its railway circuit, one of the motors it had on exhibition at the convention.

### The McKinley Bill.

The following carefully compiled data shows, to a great extent, how the street railway industry is, or will be affected by the passing of the new customs law.

#### SCHEDULE A.

Treats of chemicals, oils, paints and acids. In this department the effort of the congress to reduce that which we cannot produce is self evident so much so as to drugs that the veterinary surgeon will pay from 15 per cent. to 50 per cent. less for his medicines.

The tariff places lubricants and paint vehicles at a slight advance, that is to say, while linseed oil was subject to a tax of 25 cents, it is now 32 cents, and yet the changes will still continue to be rung on—"Supply and demand!"

In paints and varnishes "steady" is the word. In Lead products, of which the purchases are immense, are "unchanged"; while potashes are steady, sodas are 30 per cent. lower.

#### SCHEDULE B.

Earths, earthen-ware, glass-ware, brick and tile. These goods range from nothing to 25 per cent. advance, and the great standard cements are one-eighth higher. Carbonates are slightly lower, and that very important industry, glass, has not been radically changed. Marble, granite and free stone unmanufactured are held steady, while an advance of 100 per cent. upon finished goods produces other "tariff effects."

#### SCHEDULE C.

Iron, steel and other metals. Other things being equal, it is safe to say that this schedule stands among those of the first importance with regard to street railway interests. We find that everything from iron ore to bars blooms and billets, is steady; but structural shapes are lower, and in track goods 30 per cent. decrease has been assured, subject of course, to the conditions of "supply and demand." Castings as such are virtually the same, and wire has a sharp depression, unless the shapes be fanciful. Repair shops will have to pay more for anvils, but other tools are cheaper. Everything in fish plates, nails, spikes and tacks is slightly lower.

Modern types of street car fastenings are steady or lower. Car wheels will continue to run on the same gauge as formerly, but the finer metals, like aluminum, German silver, bronze and brass, are higher or steady.

Electrical men will learn with pleasure that the cost of goods, manufactured in whole or in part, of their favorite metal, copper, is decidedly lower. The finer metals, not mentioning nickel, gold and silver leaf, are in the first sharply advanced, and in the second are left steady. As of silver, so of lead, zinc and spelter, their values are left unchanged.

#### SCHEDULE D.

Wood and its products rule steady, except in the case of cedar posts, ties and telegraph posts, which were free, but now pay 25 per cent.; building materials in this line are considerably lower.

#### SCHEDULE E.

Along the Canadian border horses and mules pay a tax of \$30, while, if extra value, they are 50 per cent. higher. The item of "feed" in unison with the strangely novel idea that the agriculturist shall be encouraged, is, in some instances, such as hay, 100 per cent. higher. These effects are necessarily local. It will now cost no more to salt your tracks to-day than it did yesterday; but if tin roofs are put on cars or buildings, under certain circumstances, somewhat remote, a higher price will be paid for the tin.

#### SCHEDULE J.

Says, that flax, hemp and jute manufactures are to be steady or lower.

#### SCHEDULE K.

Relates to wool and its products, and in carpets and upholstering there is quite an advance.

#### SCHEDULE M.

Pulp, paper and their products have been permitted to remain as before.

#### SCHEDULE N.

Relates to sundries, and we find that it will cost more to day to brush and dust the horse and cars than it did before the McKinley bill went into effect. Leather and its products rule precisely the same.



# The Street Railway Gazette.

S. L. K. MONROE, - - - - - MANAGER.  
 E. V. CAVELL, - - - - - EDITOR.  
 EDWARD J. LAWLESS, - - - - - ASSOCIATE EDITOR.  
 W. L. S. BAYLEY, - - - - - MECHANICAL EXPERT.

## GENERAL OFFICES:

### CHICAGO:

8 LAKESIDE BUILDING.

AGENCIES } San Francisco, - - - 1222 Bush Street.  
 } Toronto (Canada), - - - 53 Magill Street.  
 Cable Address=TRAM, CHICAGO.

Annual Subscription (Including Postage).	Per Copy
United States, Canada .....	\$2.00. .... 25c.
Great Britain, Ireland, India, Australia .....	10s. .... 1s.
Germany .....	9mk. 75 pf. .... 89pf.
France, Belgium, Switzerland.....	2fr. 95c. .... Fr 1.10.
Spain.....	21ps. 95c. .... Ps 1.10.
Austria, Holland.....	6fl. 74c. .... 55c.
Italy.....	12 lire. .... 1½ Hra.
Venezuela.....	12 bollvar. .... 1½ bol.
Mexico.....	\$3.00. .... 30c.

Annual Subscriptions in Argentine Republic, 2½ peso; Brazil, milreis; Turkey, 54 piasters.

[Entered at the Chicago post-office as second-class matter.]

\*\*

Matter for publication should reach the Chicago Office not later than the last day of each month. All communications should be addressed, THE STREET RAILWAY GAZETTE, Chicago, Ill.

*"A Merry Christmas and a Prosperous New Year to all."*

## TO OUR FRIENDS.

With this issue the GAZETTE completes its fifth year of existence, and it is with a feeling of justifiable pride that its publishers, in looking back in retrospect over its career, realize that in the race for recognition it has earned and received its full percentage.

To our many friends, subscribers and advertisers, to whose unvarying faith and confidence in our publication we are indebted for its prosperous condition, we extend our deepest gratitude, and sincerely trust that they may still continue to honor us with their most valuable cooperation.

For the ensuing year we beg to assure them that "no stone will be left unturned," to enhance the value of the GAZETTE, both in the dissemination of knowledge useful to our readers, and in increased circulation for the benefit of our many advertisers.

In conclusion, we venture the hope that the past year has been prolific of increased earnings to our constituency, and that the one upon which we are soon to enter may prove of unusual prosperity to all.

### William B. Knight—Deceased.

It becomes our sad duty to record the passing away of one of the brightest engineers in the country—Mr. William Baker Knight, of Kansas City—who died from injuries received in the fatal collision at Jacksonville, Ill., on the 4th inst.

Mr. Knight was one of those men who, by sheer hard work, push and energy, had won an enviable reputation among the engineering fraternity, and his untimely death, while yet in the prime of his manhood—he was only 42 years of age—is an event of unusual sadness.

While it fully recognizes the fact that regrets and condolences can not bring back the lost one, yet the GAZETTE extends to the bereaved wife and children the assurance of its sincere sympathy in their sorrow in the loss of a kind and tender husband and a loving father.

### Effect of the McKinley Bill upon the Street Railway Industry.

"We will reduce where we cannot produce."—Congress.

That the effect of the new customs law, commonly known as the McKinley Bill, will be considerable, so far as the street railway industry is concerned, is obvious, and in order to give our readers a clear and succinct idea as to what that effect will be, we publish in another column of this issue, a synopsis of the same, schedule by schedule, especially so far as articles in use by street railway companies are concerned.

The GAZETTE, recognizing as it does, no party whatever in the body politic, is confident that whatever it may say with regard to any constitutional enactments, will be accepted as the opinion at which it has arrived, after a most careful and diligent research into the matter, and cannot be justly charged with knowingly mis-stating, for partisan purposes, theories or conditions. It would be well if as much could be said of the political press, but this may not be, at least not for the present, and perhaps not in our day. In this novel presentation of so important a matter as governmental financial enactments, we wish to assure our readers that nothing could be more fallacious than the assumption that the effects of a high or low tariff enactment are immediate or positive, for far away up in the towers of the great marts of commerce the huge bell is continually calling with its iron tongue, "Supply and demand! Supply and demand," thus indicating in no uncertain tones that this great regulator still controls the commerce of the world, whether tariffs go up or tariffs go down. As equilibrium is the mechanical balance wheel by which the great indicator moves, so does the equilibrium of trade stand forth and in no uncertain terms demands prosperity. Gluts there may be, abnormal developments there have been in certain branches of trade, but as long as seed time and harvest succeed each other, the unfavorable conditions of to day will be followed by the sunshine of prosperity to-morrow.

It will be interesting to note the intimate relations which always exist between the street railway world and its patrons. As the vehicle for all local business of our cities, this great urban and suburban power is as sensitive as thought itself. With a positive and intimate knowledge of the impulses which moved congress to pass the new law, we have for it no condemnations for possible and probable errors, but accept the enactment as the law of the land till by constitutional methods it is changed.

The free list is, in and of itself, a simple recognition of the fundamental principle that should underlie all governmental enactments, to-wit: That which we cannot produce, we will reduce. This list has been so extended as to produce radical reductions in goods having a nominal value, of \$250,000,000. It were a consummation, devoutly to be wished, that tariff legislation, relating as it does, to our financial life, could be freed from political bias. We frankly admit that several schedules will need unusually wise examinations and, let us hope, that at the first opportunity, such errors as are found may be eradicated.

## Associations.

OFFICERS, DATES OF MEETINGS, ETC.

### AMERICAN ST. RY. ASSOCIATION.

President, Henry M. Watson ..... Buffalo, N. Y.  
 First Vice-president, W. A. Smith ..... Omaha, Neb.  
 Second Vice-president, Chas. Odell ..... Newburyport, Mass.  
 Third Vice-president, A. D. Rogers ..... Columbus, O.  
 Secretary and Treasurer, Wm. J. Richardson ..... Brooklyn

#### EXECUTIVE COMMITTEE.

The President, Vice-Presidents, and  
 Thomas Lowry ..... Minneapolis, Minn.  
 D. F. Henry ..... Pittsburgh, Pa.  
 A. E. Thornton ..... Atlanta, Ga.  
 H. M. Littell ..... Cincinnati, O.  
 Thos. C. Keefer ..... Ottawa, Can.

The annual convention of the Association will be held at Pittsburgh Pa., commencing on the third Wednesday in October, 1891.

### N. Y. ST. RY. ASSOCIATION.

President, Dan. F. Lewis ..... Brooklyn, N. Y.  
 Vice Presidents, John N. Beckley ..... Rochester N. Y.  
 John S. Foster ..... New York  
 Secretary and Treasurer, William J. Richardson, Brooklyn

#### EXECUTIVE COMMITTEE.

John N. Partridge ..... Brooklyn  
 Chas. Cleminshaw ..... Troy, N. Y.  
 C. Densmore Wyman ..... New York

The annual meeting of the Association will be held at the Hotel Metropole, New York City, on September 15, 1891.

### MASS. ST. RY. ASSOCIATION.

President, Chas. B. Pratt ..... Salem  
 Vice-Presidents, H. M. Whitney ..... Boston  
 Amos F. Breed ..... Lynn  
 Frank S. Stevens ..... Swansey  
 Secretary and Treasurer, J. H. Eaton ..... Lawrence  
 Regular meeting day, first Wednesday in each month.

### THE ST. RY. ASSOCIATION OF THE STATE OF NEW JERSEY.

President, John H. Bonn ..... Hoboken  
 Vice-President, S. S. Battin ..... Newark  
 Secretary and Treasurer, Charles Y. Bamford ..... Trenton

#### EXECUTIVE COMMITTEE.

John H. Bonn ..... Hoboken  
 S. S. Battin ..... Newark  
 C. Y. Bamford ..... Trenton  
 C. B. Thurston ..... Jersey City  
 John Hood ..... Camden  
 A. Q. Keasbey ..... Elizabeth

### OHIO STATE TRAMWAY ASSOCIATION.

President, John N. Stewart ..... Ashtabula  
 Vice-President, John Harriss ..... Cincinnati  
 Secretary-Treasurer, J. B. Hanna ..... Cleveland

#### EXECUTIVE COMMITTEE.

W. B. Stewart ..... Columbus  
 The annual convention will be held at Akron, O., the second Wednesday in November, 1891.

### NATIONAL ELECTRIC LIGHT ASSOCIATION.

President, M. J. Perry ..... Providence, R. I.  
 1st V. President, E. W. Maher ..... Albany, N. Y.  
 2nd V. President, C. L. Edgar ..... Boston, Mass.  
 Sec. and Treas., Allan R. Foote ..... New York

#### EXECUTIVE COMMITTEE.

C. R. Huntley, Chairman ..... Buffalo, N. Y.  
 E. R. Weeks ..... Kansas City, Mo.  
 James English ..... New Haven, Conn.  
 J. J. Burleigh ..... New York  
 M. D. Law ..... Philadelphia, Pa.  
 M. J. Francisco ..... Rutland, Vt.  
 A. F. Mason ..... Boston, Mass.  
 John A. Seely ..... New York  
 H. K. Thurber ..... New York  
 Next convention will meet at Providence R. I. February, 1891.

### AMERICAN INSTITUTE OF ELECTRICAL ENGINEERS.

President, W. A. Anthony ..... Manchester, Conn.  
 Vice Presidents—Francis B. Crocker, Frank J. Sprague, Edward Weston, Newark, N. J.; Prof. Edward L. Nichols.  
 Treasurer, George M. Phelps ..... 150 Broadway, New York  
 Secretary, Ralph W. Pope ..... 5 Beekman St., New York  
 Managers—P. B. Delaney, South Orange, N. J.; Horatio A. Foote, New York; J. C. Chamberlin, New York; Charles C. Cuttriss, New York; Geo. B. Prescott, Jr., New York; Thos. D. Lockwood, Boston; Wm. Maver, Jr., New York; Dr. F. Benedict Herzog, New York; Prof. Wm. E. Geyer, Hoboken, N. J.; H. C. Townsend, New York.  
 General Office, 1230 W. 31st St., New York.  
 Board of Examiners—W. B. Vensize (chairman) F. W. Jones, C. O. Mailloux, E. H. Birdsall and Edward P. Thompson.



## LEGAL DECISIONS.

## COURTS LAST APPEAL.

**PRESUMPTION OF NEGLIGENCE—SAFE APPLIANCES.**—*Carter v. Kansas City Cable Railway Co.* Circuit Court of the United States, Western District of Missouri, Western Division, March, 1890.

Phillips, J., orally charging the jury, says:—This is an action for personal injuries alleged to have been sustained by plaintiff while a passenger on defendant's cable car at Kansas City. The plaintiff took passage on the car at the Union Depot station to come up into the city. From that point to the summit of the hill there is a steep incline of several hundred feet in length. Just as the car reached the summit of the incline it suddenly stopped, and then began to run backward, to the foot of the incline, with great velocity, where it collided with another of defendant's cars. The plaintiff received by this collision injuries to one of his ankles and hands. The defendant contends that the accident was from inevitable casualty, without any inculpatory act on its part; that the retrograde movement of the car was occasioned by sudden breaking of one of the shafts of the grip; and that, owing to the slippery condition of the rails from frost and snow, the downward movement of the car could not be stayed by the brakes. There are certain general principles of law applicable to this case to be kept in mind by you for your guidance. The defendant, in contemplation of law, is a common carrier of passengers for hire. As such, it undertook, in consideration of the fare paid by plaintiff, to safely carry him over its road to his point of destination. It did not undertake, however, to insure the life and limbs of such passenger. But as the public has an interest in the lives and limbs and health of its citizens no less than the individual himself, the law exacts of a carrier of passengers a high degree of caution and vigilance to prevent accidents and consequent injury. So, when the passenger is injured in the progress of the trip, the law presumes that the carrier has been guilty of negligence. In other words, when the plaintiff proves, as has been done in this case, that he took passage on defendant's train of cars, paid his fare, and received an injury, he has made out a prima facie case, and the burden of proof then shifts to the defendant to explain the circumstances of the injury. If it appears from its evidence that the injury was not attributable to the neglect of any duty which the law imposes upon it, then the prima facie case of the plaintiff is counterbalanced, and the jury, without any more, deliberation should find for the defendant. The law requires that such carrier of passengers should exercise the highest degree of care. Care, diligence and negligence are more or less relative terms. They can not always be defined arbitrarily, applicable indifferently to every state of facts. They can not always be determined abstractly. Care and negligence must necessarily be judged by the nature of the work to be done, the instruments to be used, the hazard and danger to life and limb from the character of the service to be performed by the carrier. "Ordinary care" means simply that caution and vigilance which a reasonable and prudent person should exercise under like circumstances. So the term "utmost care," which it is said the carrier of passengers must exercise to prevent injury to his passenger, must often be considered relatively, in the sense above indicated. If you find from the evidence that defendant, in the construction and equipment of its track and cars for operation, had exercised the highest degree of care and circumspection known to it; that it had employed, as its evidence tends to show, the best material which it could ascertain by inquiry and experiment to be needful for such use; that it had employed the best brakes, grips, and appliances for running, stopping, and operating such cars at such a point, and had exercised great care and caution in inspecting and testing such appliances in a mechanical and skillful manner, then there would remain another question in the case, and that is, did the defendant also exercise due care in the selection of competent servants to run the car, and put them in charge thereof on this occasion? If it did that, there remains but one other fact

for you to find in this connection, and that is, did the servants on this occasion exercise care and put forth their best efforts to prevent this accident? If you should find these facts for the defendant, the plaintiff has no case, and your verdict should be for the defendant. Gentlemen of the jury, there has been some evidence, to the effect that, a few months after this accident, some one of the skilled mechanics or engineers connected with this road devised a patent or plan by which it is supposed such an accident as the one in question could not occur, or could be prevented. In respect of this, I charge you that such subsequent discovery would not necessarily make the defendant liable in this action. It devolves upon the plaintiff to go further with his proof, and show that such new device was known to the defendant prior to this action, or that its discovery could have been made by the exercise of diligence on its part, as heretofore defined. If you are able from this evidence to find that the injury is attributable to the negligence of the defendant, the verdict should be for the plaintiff. Should you find for the plaintiff, in assessing his damages you may take into consideration his physical pain and mental anguish, if any, resulting from such pain and injury; his loss of time, medicines, and medical bills for attendance of physician. This is not a case for punitive damages, that is, exemplary damages, but you will allow only compensatory damages, such as, under all the facts and circumstances in evidence, seem to you to be reasonable and just, not exceeding the sum of \$10,000 sued for.

**IMPUTING NEGLIGENCE OF PARENTS TO INJURED CHILD.**—*Chicago City Railway Co. v. Wilcox.* Supreme Court of Illinois, May 14, 1890, 24, N. E. Rep. 419.

The plaintiff in this case at the time he was injured was a child six years of age, and was run over by one of the grip cars of defendant. The court instructed the jury that if they found that the parents of the child were working people, the father being necessarily absent in his employment, and the mother engaged in tending a store which was run by them, the law would not require them to keep constant watch over their children, and that the want of such care could not be imputed to them as negligent conduct; and that negligence could not be imputed to the child, on account of its age. There was judgment for plaintiff, and defendant appeals. The court say:—"The first part of this instruction assumes that, in an action by a child so young negligence cannot be imputed to it; to recover for a personal injury received through the negligence of another, want of proper care by its parent, guardian, or other custodian, in suffering it to go out unattended, cannot be charged to the child as contributory negligence, so as to defeat the action. The instruction also lays it down as a rule of law that a child of six years of age cannot in such case be chargeable with personal negligence. Thus two legal questions are presented for decision, upon either of which there is to be found a conflict of authorities. On the first, two well-defined lines of decisions appear, each in direct conflict with the other. We are clearly of opinion that the weight of authority and better reasoning is in support of the doctrine that in a case like this the child is not chargeable with a negligent omission of duty by its parent. There was therefore no reversible error in giving the first part of the third instruction. Bish Non-Cont. Law, sections 581-583; Whart. Neg sections 310, 314; 1 Shear. & R. Neg. sec. 78. The question as to whether, as a matter of law, personal negligence can be attributable to a child six years of age, as before stated, is also one upon which the authorities are not harmonious. Certainly no great degree of care for its personal safety is to be expected of a child six or even eight years of age; but we think it safe in each case to submit the question as to whether negligence shall be imputed to a child to the jury, as one of fact, to be determined from the particular circumstances in evidence. The third instruction took from the jury all question of the plaintiff's negligence—in fact, told them that, as a matter of law, he could not be guilty of any negligence—and for that reason was erroneous. For the error indicated the judgment of the Circuit and Appellate Courts is reversed."

**LIABILITY FOR REPAIR OF STREETS.**—*State Ex rel. City of New Orleans v. New Orleans City & L. Ry. Co.*, Supreme Court of Louisiana, April 7, 1890, 7 South. Rep. 606.

This was an application for *mandamus* to compel the defendant company to keep in repair streets upon which its tracks did not run, but which bordered and adjoined neutral ground upon which the tracks were laid. It was admitted that, by its contract with the city, the company was obliged to keep in repair, from curb to curb, such streets as were used by its tracks, and the city, in this action, sought to bring within the operation of the term "from curb to curb," streets on which its tracks did not pass, but which bordered on the sides of neutral ground which adjoined them, such as Canal, Rampart, and Esplanade streets. A *mandamus* was issued, including a command that these streets be repaired. From that decree the defendant appeals. The court says: "A careful reading of the stipulation, coupled with the consideration of the interpretation placed upon it by the parties, forces the irresistible conclusion that the space which, in their intent, the company was to keep in good order and condition, is the route through and on which its tracks would pass, extending from curb to curb, or external boundary. No other reasonable signification can be placed on the agreement. It is therefore apparent that the company is not bound, under its tenor, to perform any work beyond the curbs or lines within which are comprised the neutral or middle grounds, or strips of land, between the side streets, on which its tracks have been laid. The proof shows in what respects the company has been derelict, as to the ordinary streets, and, to some extent, as to intersections, bridges, and neutral grounds which constitute the route through and on which its tracks pass. The judgment of the lower court is correct, unless in that portion which makes the *mandamus* peremptory as to the streets and thoroughfares which extend on the sides and beyond the curbs of the strips of ground in question. It is therefore ordered and decreed that the judgment appealed from be amended by striking therefrom that portion which imposes on the defendant company the obligation of keeping in good order and condition the streets and road-ways on the sides of the middle or neutral grounds on Canal, Rampart and Esplanade streets in this city, and by rejecting the demand in that respect, and that, thus amended, said judgment be affirmed, at appellee's cost."

**LIABILITY FOR INJURY OF PASSENGER NEGLIGENTLY RIDING ON PLATFORM.**—*Baltimore & Y. Turnpike Road v. Cason*, Court of Appeals of Maryland, June 19, 1890, 20 At. Rep. 113.

This was an action sustained for personal damages by appellee, who was riding at the time of the accident on the front platform of the car, and fell off while reaching in his pocket for money with which to pay his fare. There was no evidence of negligent construction or management by appellant, and there was ample room inside the car for appellee. Notices were posted warning passengers against riding on platforms. From a judgment for plaintiff the company appeals. The court says: "There can be no doubt that the conduct of the appellee directly contributed to the production of the injury which he sustained. It was held by this court in *Railway Co. v. Wilkinson*, 30 Md. 232, that a regulation forbidding passengers to get on and off any car by the front platform was reasonable, and that to knowingly violate it was conclusive evidence of negligence on the part of a passenger. There is an obligation imposed on the passenger to observe the reasonable regulations of the company in entering, occupying, and leaving cars; and, if a party be injured in consequence of a known violation of such regulations, unless compelled thereto by some existing necessity beyond his control, the company is not responsible. *Railroad Co. v. Zebe*, 33 Pa. St. 318. And when the plaintiff's own evidence shows that he took a place not assigned for passengers, but which they are expressly prohibited from occupying, and put himself in an exposed and per-



ilous position, he must necessarily fail, unless he can also make it appear, upon some ground of necessity or propriety, that his being in that position was consistent with the exercise of proper caution and care on his part. *Hickey v. Railroad Co.*, 14 Allen, 432. If he knew the regulations forbidding him to stand or sit on the front platform, he had no right to disregard it, even though the conductor or driver allowed him to do so, there being ample room for him to stand inside the car. When sufficient and suitable provision is made within the cars for all the passengers, the managers of the train are not under obligation to restrict them to their proper places, nor to prevent them from acts of imprudence, if they are old enough and intelligent enough to take care of themselves. 'If they voluntarily take exposed positions, with no occasion therefor, nor inducement thereto, caused by the managers of the road, except a bare license by non-interference, or express permission by the conductor, they take the special risks of that position upon themselves.' *Sweeny v. Railroad Co.*, 10 Allen, 368. The regulation was conspicuously posted in every car, and the appellee, who used the cars frequently, was able to read. He had the means at hand to fully inform himself, and the exercise of the slightest care would have advised him of the contents of these notices. The word 'Warning,' printed in large, full-faced type, at the top of the card, ought to have attracted his attention. In questions of negligence, a person is held to know that which he ought to know for his own safety, and which, by the exercise of reasonable care, he could have known. *Railroad Co. v. Kane*, 69 Md. 23, 13 At. Rep. 387. The conductor and driver had no authority to relax it. The accident was the direct result of the appellee's infraction of it. Had he been inside the car, where he ought to have been, the injury would not have been sustained. His own voluntary choice placed him in an exposed position, and that position rendered the injury possible. *Dietrich v. Railway Co.*, 58 Md. 359. Under these circumstances, his conduct amounted in law to contributory negligence, and he will not be allowed to visit upon the company, even assuming it to have been negligent, the consequences of his want of prudence and care. Judgment reversed."

#### CRIMINAL LIABILITY OF OFFICERS FOR NEGLIGENCE OF TRACTS.

*Town of Oxanna v. Allen*, Supreme Court of Alabama, June 19, 1890. 8 South. Rep. 79.

The town of Oxanna passed an ordinance making it unlawful for any street railway company to permit its road-bed or track to remain so high above the surface of the streets as to interfere with public travel, and declaring that the officers of the company should be subject to a fine if the ordinance should not be complied with. The superintendent was arrested for violation of the ordinance and was dismissed, the town appealed, and the court say: "We are content to rest this case on a single proposition. The ordinance in question was, in our judgment, void for unreasonableness so far as it was applicable to the appellee. True, it has reference to a subject-matter within the corporate jurisdiction, and the rule is that in such cases a municipal ordinance will be presumed to be reasonable, *prima facie*, unless the contrary appears on the face of the law itself, or is established by proper evidence. *Van Hook v. City of Selma*, 70 Ala. 361. But where an ordinance enacted in pursuance of an implied power is plainly and clearly unreasonable, the courts will not fail to so adjudge it, and, of consequence, to pronounce it void. *Horr v. B. Mun. Ord.*, Secs 127-132; 1 Dill Mun. Corp (3d Ed.) Sec. 319. The ordinance under consideration is oppressive in character so far as concerns the appellee, Allen, and therefore unjust beyond the bounds of reason. 'The courts' says Judge Dillon, 'will declare void ordinances that are oppressive in their character.' 1 Dill Mun. Corp. Sec. 321. It undertakes to make the superintendent of a street railway company responsible quasi criminally for the failure of the corporation to expend money in putting the railway track in suitable repair. He has no authority to remove the track. He was under no duty to pay his own money to have it repaired. He may have had no money to pay. His duties

as superintendent were limited to the authority conferred by the corporation for which he acted. If the directors or other governing body failed to appropriate money for repairs, he manifestly had no power to make them. He should not, therefore, be held responsible for any dereliction or negligence on their part. It would be unreasonable and oppressive to so hold him, under the facts of this case. The judgment of the city court is free from error, and is affirmed."

#### DUTY OF DRIVER TO ALIGHTING PASSENGERS.

*Birmingham Union Railway Co. v. Smith*, Supreme Court of Alabama, June 19, 1890. 8 South. Rep. 86.

The plaintiff and appellee was injured by being thrown from one of defendant's cars which was suddenly started up as she was alighting. The question was as to the degree of care required of the driver. Defendant appeals from a judgment for plaintiff. The court say: "The rules which apply to ordinary steam railroads with reference to the discharge of passengers do not obtain with respect to a horse railway. They have no stations; no regular stopping places, no schedules. The driver cannot know beforehand where any passenger intends to alight, or how many passengers desire to get off at any place where he is signaled to stop. When he is signaled to stop, he must then inform himself by looking and seeing as to how many of his passengers desire and intend to alight. Without this he can have no conception of the length of time the car should remain stationary. Having rendered his car immovable by applying the brakes, he has nothing else to do than to see who intends getting off, and to know that they are safely off before the car is again started. It is entirely practicable for him to do this. The only exits are under his immediate observation, and there is no other duty incumbent on him at the time to divert his attention from them and the alighting passengers. Our opinion is that it is the duty of a driver of a horse-car, when signaled to stop, at least to ascertain who and how many of his passengers intend to alight at that place, to wait a sufficient length of time to enable them to alight in safety by reasonable diligence, and in any event, to see and know that no passenger is in the act of alighting, or is otherwise in a position which would be rendered perilous by the motion of the car, when he again puts the car in motion. If he fail in any of these respects, and injury results from such failure, his employer is liable. *Thomp. Carr* 443; *Poulin v. Railway Co.*, 61 N. Y. 621; *Nichols v. Railway Co.*, 38 N. Y. 131; *Railway Co. v. Munford*, 3 Amer. & Eng Ry. Cas. 312-315. See, also, *Railroad Co. v. Calderwood*, 7 South. Rep. 360. Charges 4 and 5 were therefore properly refused, and the judgment is affirmed."

*Ashton v. Detroit City Railway company*; Supreme Court of Michigan, December 28, 1889. 44 N. W. Rep., 141.

Mrs. Ashton, the plaintiff in this case, took a Russell street car on the line of defendant to go to her home, which was a short distance beyond the end of the line on Ferry avenue. The barns on Ferry avenue were some distance from the end of the line, and when the car approached the barn, instead of carrying plaintiff on to the terminus of the line, the driver turned and drove the car into the barn a number of car lengths, and when she left the car in the barn, who laid hold of her and made indecent proposals to her until she broke away from him and ran to her home, thereby escaping from his further violence and insults. The plaintiff further claims that on a subsequent occasion she was again a passenger on this same line of cars. This time, as before, she intended to ride to the end of the line, and again the car turned into the barn, as it had on the previous occasion. She remembered her experience at that time, and rang the bell to stop the car. Finding that it did not stop, she waited a second, and then went out on the rear platform and got off while the car was in motion, being thrown by so doing, and injuring her knee. She recovered judgment for \$500, from which defendant appealed. The court say: "The circuit judge was right in receiving the testimony brought out by the question: 'Will you state to

the jury what happened when you alighted from the car in the barn?' referring to the occasion prior to that on which she was injured. This was offered as a reason for justifying her leaving the car while in motion; to show that the place to which she was being taken by the company was one not only improper for ladies, but to the plaintiff it had proved to be dangerous. The fact that the driver did not respond to the ring of the bell was to the lady a suspicious circumstance, and to what extent she had cause to fear and did fear danger approaching as she neared the barn, were proper subjects for the consideration of the jury, and were properly left to them. I think whether or not the treatment the plaintiff received in the defendant's barn when she was taken there was sufficient to justify her belief that she was avoiding an actual impending danger, into which she was being taken, by leaving the car, was a question for the jury and not for the court. It was of no consequence what the car-driver or his company knew or believed in regard to the insult offered to the plaintiff in defendant's barn. The real question was, assuming the testimony of the plaintiff to be true, what reasonable ground had she to expect she would receive insult or injury, and is she to be deemed negligent in doing the only thing which was left for her to do, by the action of defendant, in avoiding such insult and injury?" Judgment affirmed.

LIABILITY FOR STOPPING CARS AT DANGEROUS PLACE.—*Richmond City Ry. Co. v. Scott*. Supreme Court of Appeals of Virginia, May 1, 1890. 11 S. E. Rep. 404.

This was an action to recover for damages sustained by passenger, who was injured while alighting from a street car by falling into a ditch excavated at the side of the track by the city authorities. The contention turned upon the point whether or not the company was bound to deliver its passengers at a point of safety, or whether, upon alighting from the car, the passenger took the responsibility for his own safety upon himself. From a judgment for plaintiff defendant appealed. The court say:—"Passenger carriers bind themselves," says the learned author—"to carry safely those whom they take into their coaches, as far as human care and foresight will go; that is, to the utmost care and diligence of very cautious persons." *Thomp. Car.* p. 443, sec. 3. *Farish v. Reigle*, 11 Grat. 697; *Railroad Co. v. Cooper's Adm'r*, 9 S. E. Rep. 321. And in *Railroad Co. v. Prinnell*, 3 S. E. Rep. 95, this court said:—"The implied contract to carry safely includes the duty of giving the passengers reasonable opportunity to alight in safety from the train, and a violation of this part of the company's duty is culpable negligence, for which an action will lie." In *Whart. Neg.* sec 649, it is laid down that "when a danger approaches, it is the duty of the officers of the road to notify the passengers, so that they can take steps to avoid it; and failure to give such notice is negligence. So, also, if there is a dangerous place at the landing, it is the duty of the conductor to warn those about stepping out." And he adds: "He must give notice to all, if any danger in alighting is probable." In *Cartwright v. Railway Co.*, 52 Mich. 606, 18 N. W. Rep. 380, *Cooley, C. J.*, says:—"If a car in which there were passengers was not standing where it would be safe for them to alight without assistance, it was the duty of the company to provide assistance, or give warning, or to move the car to a more suitable place." See, also, *Railroad Co. v. Whitfield*, 44 Miss. 466; *Railroad Co. v. Buck*, 96 Ind. 346; *McGee v. Railroad Co.*, 92 Mo. 208; 4 S. W. Rep. 739; *Maverick v. Railway Co.*, 36 N. Y. 378. These authorities show the extent to which the liability of carriers of passengers goes in cases like the present, and by this liability street or horse railways, as well as other classes of carriers of passengers are bound. *Railroad Co. v. Twiname*, 111 Ind. 590, 13 N. E. Rep. 55; *Smith v. Railway Co.*, 32 Minn., 18 N. W. Rep. 827; *Railway Co. v. Higgs*, 38 Kan. 375, 16 Pac. Rep. 667; *Railway Co. v. Findley*, 76 Ga. 311; *Barrett v. Railroad Co.*, 45 N. Y. 628; *Hill v. Railroad Co.*, 10 N. Y. 239, 16 N. E. Rep. 61. We can perceive no ground upon which to question the correctness of the verdict or judgment. It was plainly within the power, as it was within the duty, of the



defendant to have pursued one of these courses as either of which would have prevented the accident. It might have stopped at some safe spot short or beyond the excavation, or have directed Mr. Scott to alight on the eastern side of the car, or, if it chose to permit him to debark from the western side of the platform of its car, it should have warned him of the excavation and have assisted him over it. It chose to do neither, and must pay the penalty. The judgment of the circuit court is right, and must be affirmed.

USE OF STREETS FOR "DUMMY RAILROAD." *East End St. Ry. Co. v. Doyle*. Supreme Court of Tennessee, May 3, 1890, 13 S. W. Rep. 936.

The court say:—This case presents the question preserved in the Smith case, 87 Tenn. 626, 11 S. W. Rep. 709, namely, whether a railway whose cars are propelled by a dummy steam-engine, and used for passengers only, is a burden or servitude on a public street or highway in addition to that contemplated in the original dedication of the land to public use. In the present case, the plaintiff's line is in the center of the highway, and to that line he owns the ultimate fee; that is, he has such ownership of the soil that he may resume absolute possession and dominion of it to the center of the highway whenever the original use for which the highway was set apart shall be finally abandoned. The appropriation vested the public with only such part of his fee-simple estate as was necessary to the full enjoyment of the use then in contemplation. Consequently, anything which diverts the highway from that use, or applies it to another or different use, is the imposition of an additional burden on the reserved estate of the owner, and constitutes a taking of his property, for which he may demand and receive just compensation. It is well settled that an ordinary steam or commercial railway is, and that an ordinary street railway operated with horses is not, an additional servitude on the ultimate fee in the public street or highway; the former being a new and different use, while the latter is but an improved and consistent mode of enjoying the original or ordinary use. *Railroad Co. v. Bingham*, 87 Tenn. 522, 11 S. W. Rep. 705; *Smith v. Railroad Co.*, 87 Tenn. 626, 11 S. W. Rep. 709, and authorities cited. The distinction between the use by the commercial railway and that by the horse railway is so wide and plain that it needs no further comment or illustration. Confessedly, the railway involved in this case is on the line between the two; the equivalent of neither, but partaking largely of the nature of both. Like those upon the commercial railway, its cars are propelled by a steam engine, with its unavoidable smoke, noise and vibration, though in a less degree; and, like the horse-car line, it transports passengers only, stopping at intervals upon the highway to take them on and let them off, while a commercial railway carries both passengers and other freight, receiving and discharging them at regular depots further apart. The size, weight, and speed of appellant's train, consisting usually of a small "boxed" engine and two coaches, are much less than those of the commercial railway trains; but, at the same time, its trains are much longer, heavier, and more rapid in transit than the ordinary horse car. Alike, the commercial railway and that operated by appellant are obvious hindrances to other modes of travel and traffic rightfully upon the public highway. Alike, they endanger the lives and property of individuals for whom, in the aggregate, the original dedication or condemnation was made. There is a difference, it is true, but the difference is in the degree, and not in the kind, of interruption and peril. From the very nature of the case, it is perfectly manifest to our minds that the presence of the appellant's track and trains is entirely inconsistent with, and a perpetual embarrassment to, the ordinary use of the public highway. It is utterly impossible to operate such a railway with such trains without greatly obstructing and rendering more dangerous other business and travel usually seen, and always allowable, on a public highway. To the extent of this obstruction, and this increase of danger by its appropriation of the highway for its own purposes, there is necessarily a diversion from and inconsistency with the original use; and to that extent the construction and operation of appellant's road is the imposition of

an additional servitude upon the ultimate fee of the owners of the soil in the public highway. This does not mean that the trains of appellant are to be banished as unauthorized by law, but simply that their presence and operation in the public highway is an additional burden on the ultimate fee, for which the owner is entitled to compensation."

CHANGE OF HORSE TO CABLE RAILWAY IN NEW YORK.—*In re, Third Ave. Railway Co.*; Court of Appeals of New York, June 17, 1890 24 N. E. Rep. 951.

The Third Avenue Railway company was organized under the laws of New York, prior to January 1, 1875. In February 1887, it resolved to change its motive power from horse to cable. The Constitution of New York, which became of force January 1, 1875, after the organization of the road, provides that no law shall authorize the construction of a street railway without the consent of the local authorities as well as the property owners. The commissioner of public works refused his consent to the change, and the Court of Appeals refused to compel him to do so, upon the ground that he was not obliged to issue the permit unless he desired to. Thereupon the company secured the passage of a law in 1889, giving any horse railroad company the right to change its motive power to anything but steam, upon consent of the property owners, and approval by the state railway commissioners, without the consent of the local authorities. Under this act the commissioner still refused to allow the company to open the streets, on the ground that the law was in conflict with the constitutional provision above referred to. The court, on appeal from the supreme court sustaining the commissioner, say:—"The act of 1889 did not authorize the construction of this railroad. It was already constructed, and had been in operation for many years. It was a street surface railroad before and was to remain so. It took no right to operate its road under the act of 1889; and, resting upon that act alone, it could not operate its road. That simply confers the right to adopt a new motive power, and so far it is a regulating act. It confers no substantial franchise to conduct or operate a road. It specifies how the chartered obligations of the company may be performed, and its chartered rights exercised. The powers and franchises of street railways existing prior to 1875 may be regulated without violating the constitutional provision referred to, and this may be done by enlarging as well as restricting them. The manner in which an existing franchise to operate a railroad may be exercised is matter of regulation, and is generally within the absolute control of the legislature. It is the same railroad; and, when operated by means of a cable, it will not materially increase its interference with the street for all street purposes. It is true that the act of 1889 confers a new or additional franchise upon an existing railroad company, and authorizes it to impose upon the streets a greater or different burden; but there is nothing in the constitution which prohibits this. The legislature could, without violating the constitution, authorize an independent company or private individuals to place in any street of the city a cable for the traction of cars or other vehicles lawfully owned and maintained by others. By so doing, it would not in any proper sense authorize the construction or operation of any railway. If it could authorize any independent company or private individuals to do this, it could authorize the railroad company itself to do it. These views find some sanction in the cases of *In re New York Gilbert El. R. Co.*, 1d., 361, and they are not in conflict with anything decided in *Astor v. Railway Co.*, 113 N. Y. 93, 20 N. E. Rep. 594. We are therefore of opinion that the orders of the general and special terms should be reversed, and the application for the mandamus granted, with costs in all the courts."

CARE OF BRIDGES AND CROSSINGS. FAILURE TO CALL AS WITNESS, EMPLOYEES PRESENT AT ACCIDENT.—*Peetz v. St. Charles St. Ry. Co.*; Supreme Court of Louisiana, May 5, 1890. 7 South Rep. 688.

This was an appeal from a judgment rendered

against the company defendant, for damages sustained by the plaintiff in stumbling over a plank nailed on a bridge where she was alighting from defendant's car. Because defendant failed to call as witnesses any of its employees, the court below was requested to charge the jury that such failure raised a presumption of negligence on the part of the company. This was refused. The court say:—"The President of the company, who is also the superintendent, testified that he made efforts to ascertain who had nailed that plank, and could not find out who had put it there. We will first pass upon the refusal to charge as requested. In support of this proposition, the following from Thompson on Negligence (Vol. 1, p. 514) is referred to: "An absence, from the trial, of the employees of defendant who were on the cars and present at the time of the accident, and were witnesses of the injury, raises a strong presumption of negligence against the company." The case at bar is not similar. It is not shown that the employees knew who nailed this plank; that they had anything to do with it. Inquiry was made by the principal officer of the company with reference to the plank. He did not ascertain, he testifies that the employees knew anything about it. While all those intrusted with the keeping of bridges in good repair, should be active and exceptionally careful in the performance of that work, on the other hand those who cross these bridges are not entirely relieved from the necessity of exercising some little care and of giving some attention to their steps. The plank was not of extraordinary thickness, and was securely nailed on the bridge. It is not shown by whom it was put on, or that the defendant company that had notice of the condition of this bridge, or any complaint was made prior to the accident, or that the crossing was at all hazardous. To hold for plaintiff, would be, in effect, to decide that whenever an accident occurs on uneven sidewalks, on in crossing bridges not level, without regard to the lack of care, damages can be recovered. It would be to decree, in effect at least, that all bridges and sidewalks should be level, and that nothing about them should be in the least rugged or uneven. Judgment reversed with costs."

It is claimed for the Indurated Fire Pipe, which has attracted so much attention at the recent Buffalo Convention, that it is an absolute non-conductor of electricity, and that it will not expand or contract under variation of temperature. For the underground feeder system it would appear to us that this pipe is admirably adapted, as it is practically imperishable underground; is light, strong and durable, and impervious to the deteriorating influences of either gas or water. Its tensile strength is reputed to be over 1,000 pounds to the inch, while it will stand a pressure of 200 pounds to the inch.

PITTSBURGH, PA., Aug 28, 1890.

STANDARD PAINT CO., Ralph L. Shainwald, President, No. 69 Maiden Lane, New York, N. Y.

Dear Sir:—In reply to your inquiry, we take pleasure in advising you that we are thoroughly satisfied with your P. & B. paint and electrical compound; we have used many hundred barrels of it during the past two years, and believe it to be unequalled—certainly unexcelled—in penetrating and preserving qualities. We have used large quantities of it for coating lead covered cables, to protect the lead from chemical actions, and have found it to be thoroughly efficient, either as a simple coating on the lead, or for saturating a fibrous jacket put over the lead. We have no hesitation in recommending it in the highest terms for the purposes for which you sell it, and remain,

Very truly yours,

STANDARD UNDERGROUND CABLE CO.

Per J. W. MARSH,  
Sec. and Asst. Gen. Man.

St. Louis, Mo., has perhaps more electric railway lines in operation than any other one city in the United States. There are four separate and distinct lines in that city equipped with the Thomson-Houston railway system, in addition to which there is one line across the suspension bridge at that place which is equipped with the same system, and a smaller line immediately across the river from St. Louis connecting with the bridge line, which is also equipped with Thomson-Houston apparatus. The total number of cars equipped with the Thomson-Houston system in St. Louis is 139, the number of motors 278, the total horse power of which is 4,170.



## STREET RAILWAY NEWS.

## ALABAMA.

**Florence**—A new syndicate has purchased the property of the Street Railway Co. here, including the dummy line, and it is expected that it will put it in good running order at once.

## ARKANSAS.

**Pine Bluff**—The Citizens and what is known as the Jones line, have been consolidated, the Citizens line, having passed into the hands of Mr. Wiley Jones and his syndicate. We understand the consideration was \$120,000. There are now about 14 miles of road embraced in the new company's system.

## COLORADO.

**Colorado Spring**—Electric cars are now running between this point and Manitou.

## CALIFORNIA.

**Trensel**—The poles for the electric road here, are now being placed in position.

## DELAWARE.

**Dover**—An electric railway here is now a sure thing.

## GEORGIA.

**Atlanta**—The Atlanta, West End & Westview St. Ry. Co. has asked permission to construct an electric line.

The Electric Light Committee of this city has granted the right of way to the Atlanta, West End & McPherson's Barrack St. Ry. Co. It has also granted permission to build a double track on Marietta St., and to use electricity on that and other lines, to the Atlanta St. Ry. Co.

## KANSAS.

**Kansas City**—A mortgage for \$150,000 has been filed by the West Side Ry. Co., in favor of Farmer's Loan & Trust Loan Co. of New York, for the purpose of constructing the proposed electric line on the North Side, and a deed of trust covering the entire property of the company has been filed with the register of deeds. The bonds run 15 years with 6 per cent. interest payable semi-annually.

## RHODE ISLAND.

**Providence**—The Union Railway here, earned \$380,000 gross and \$175,000 net in the year ending Sept. 30, 1890, a gain of \$10,000 net. Dividends of 8 per cent., \$120,000 were paid, leaving a surplus of \$55,000 for the year and \$481,000 total surplus. A consolidation with the Pawtucket Street Railway company is mooted. The former company is said to own 60 per cent of the stock of the latter.

## ILLINOIS.

**Aurora**—We understand that a project is on foot, for the construction and operation of about 5 miles of street railway, to be operated by storage battery, here. Another company is now constructing something in the neighborhood of 12 miles of road, to be operated by the overhead system.

## IOWA.

**Burlington**—Eastern capitalists are interested in the construction of an electric road here, and a \$10,000 bond has been filed by them, guaranteeing the road to be in operation by July 1, 1891.

**Dubuque**—A trust deed for \$100,000 has been filed by the Key City Elec. St. Ry. Co. here, in favor of Wm. G. Stewart, for the purpose of paying off the old mortgages and building further extensions.

## KENTUCKY.

**Covington**—The South Covington St. Ry. Co., has made an arrangement with the Suspension Bridge Co., whereby the latter receives the sum of \$32,850 for tolls per year from the Railway Co., and assumes the responsibility for all damage resulting to vehicles or passengers from the construction of the electric wires, etc., across the bridge.

## MASSACHUSETTS.

**Boston**—Mary Hall has been awarded a judgment of \$9,100 against the West End Ry. Co., claimed to have been sustained by her while a passenger on one of the company's cars.

The Quincy and Boston St. Ry. Co. of Quincy, has voted to increase the capital stock from \$50,000 to \$100,000. It is intended to improve the roadbed of the electric road in order to stand the wear of heavier traffic.

**Lowell**—The Lowell Horse R. R. Co., and the Lowell and Dracut St. R. R. Co., has been accorded permission to adopt electricity as a motive power.

## MICHIGAN.

**Jackson**—The electric street car project here, has now taken definite shape, and a new company will probably be composed of the following named gentlemen, who will at once award contracts for the construction and equipment of the road: Hiram H. Henry H., and Dwight S. Smith of Jackson, and John D. Corliss of Detroit, which latter named gentleman is, we understand, connected with the Thomson-Houston Co.

## MINNESOTA.

**Minneapolis**—The Medicine Lake Elec. Ry. is to be built in the spring, and will probably run out 6th Ave. from Penn Ave.

## MISSOURI.

**Kansas City**—The Vine St. Motor Ry. Co. has filed a trust deed to its property, in the consideration of \$100,000.

The America National Bank has instituted suit against the Peoples Cable Railway Co. on a promissory note for \$5,000; the note is long past due; and secured all stock of the company. The company is now in the hands of Receiver H. P. Churchill.

## MONTANA.

**Anaconda**—The Electric Railway and Power Co. of this city, has nearly completed its plant. The plant will be operated by water power, 900 h. p. being generated for the purpose of transmission.

## NEBRASKA.

**Beatrice**—Construction of the line of the Beatrice Rapid Transit & Motor Co. has been commenced, and the company promises to have it in operation by Jan. 1.

The Glenover St. Ry. Co., mention of which has been made in a previous issue of the GAZETTE, is also building with a view of adopting electricity as a motive power.

**Lincoln**—The North Lincoln St. Ry. Co. has filed amended articles of incorporation, changing its name to the Lincoln City Electric Ry. Co.; the capital stock of which shall be \$250,000 of \$100. each, and the object of the company is to construct and operate a system of street railways in the city of Lincoln, and to own and operate an electric plant for the purpose of furnishing light and mechanical power.

A list of the Board of Directors will be found under the head of "Elections" in this issue.

## NEW JERSEY.

**Mt. Holly**—We understand that the contract for the construction of a street railway here, has been awarded to W. P. Craig of New York, and work has been commenced.

**Trenton**—The Trenton Horse R. R. Co. is using boys as conductors, and from all accounts, the boys are giving satisfaction, are liked by the passengers and to the operating company.

## NEW YORK.

**Albany**—The Albany Railway Co has received 7 new cars from the works of the Gilbert Car Mfg. Co. of Troy.

**Auburn**—The Auburn St. Ry. company has been accorded permission to change its motors power from horse to the overhead single trolley electric system.

**Brooklyn**—The Brooklyn City Ry. company has received permission from the State Board of Ry. Commissioners, to change its motive power from horse and steam to electricity under the single trolley system.

**New York**—At the annual meeting of the directors of the Third Avenue R. R. company, the president stated that the cable road would probably be in operation by Oct. 1st, 1891. The business of the road shows an increase in 1889 of \$181,981 over 1888, and an increase this year of \$97,014 over last year, a total for the two years equivalent to 5,579,920 passengers. The receipts for the year amount to \$1,638,342, showing that 38,668,849 passengers have been carried. (A list of the officers and directors will be found under the head of "Election" in the present issue.)

The capital stock of the Houston West St. & Pavonia Ferry R. R. company has been increased from \$250,000 to \$1,050,000. The company also operates the Chambers St. and Grand St. Ferry R. R., and the purpose of increase of stock is to facilitate the consolidation of the two companies.

**Rochester**—The Rochester Ry. company has bonded its property in the sum of \$3,000,000, 40-year consolidated mortgage 5 per cent. gold bonds, which are in the hands of John Payton & Co., of New York. They are dated April 1, 1890, and will mature on April, 1930; interest is payable on Oct. 1, of each year at the offices of the Soldiers Loan & Trust company, Philadelphia, which is also a trustee under the mortgage. Out of these bonds \$1,000,000 will be held in the treasury for the purpose of retiring at maturity \$875,000 worth of bonds, which existed at the time the road was purchased.

**Utica**—A special meeting of the stockholders of the Belt Line road will be held here on the 17th inst. to pass upon a proposition to mortgage the road for \$200,000, in order to defray expenses of extensions in betterments.

## NEBRASKA.

**Omaha**—Susan A. Sutton, 63 years old, has brought suit against the railway company for \$10,000 damages as recompense for the injuries she received in being thrown from a Capital Heights' car on Aug. 14th, whereby her left thigh was broken, and she rendered a cripple for life.

## NORTH CAROLINA.

**Raleigh**—Dr. S. W. Jacobs, of Sioux City, Ia., has purchased the property of the Street Ry. company here, and will at once commence the construction of an electric system; contracts for which plant together with 6 miles of rail have already been made. We understand that some New York parties are also interested in the deal.

## OHIO.

**Cleveland**—The Broadway & Newburg St. R. R. company has increased its capital stock from \$500,000 to \$1,000,000.

The Broadway & Newburg St. R. R. company will lay some new tracks of 82 lb. girder rail.

**Cincinnati**—The Cincinnati St. Ry. company has increased its capital stock from \$5,500,000 to \$6,000,000.

## PENNSYLVANIA.

**Beaver Falls**—The Central Electric Ry. company has a charter to operate an electric line through Beaver Falls, New Brighton, Bridgeport and Beaver.

**Connellsville**—A company is being organized for the purpose of building an electric line between this point and Leisening.

**Uniontown**—The contract for an electric street railway here has been placed with the Pittsburg Construction company.

**West Chester**—An order for three new cars for this road has been placed with the J. G. Brill company, of Philadelphia, for January delivery.

## VIRGINIA.

**Richmond**—The Richmond Ry. and Electric company, which recently absorbed two street car and three electric light and power companies, has filed a mortgage of \$2,000,000 to secure the Atlantic Trust company of New York City.

## WISCONSIN.

**Appleton**—The Appleton St. Ry. company has decided to suspend all operations of its line until spring, it being claimed that it cannot operate it with profit to itself or convenience to the public.

**Janesville**—Geo. R. Clark has been awarded a judgment of \$300 against the Janesville St. Ry. company for injuries received while traveling over that company's road.

## WASHINGTON.

**Ballard**—An electric railway will be in operation here in the immediate future.



## NEW ENTERPRISES.

## BRITISH COLUMBIA.

**VanCouver**—The Vancouver St. Ry. Co., capitalized at \$30,000, has been incorporated.

## COLORADO.

**Denver**—It is highly probable that an electric line will be built from this point to Golden in the near future. The Denver, Lakewood & Golden Ry. Co., capitalized at \$250,000, was formed during the past summer for that purpose, but it was found upon investigation that more money would be needed.

A list of the officers and directors will be found under the head of "Elections" in this issue.

## GEORGIA.

**Athens**—A charter has been granted to the Athens Belt Line R. R. Co. to operate a line one mile in length. The company is capitalized at \$15,000, and the following named gentlemen are interested: Rufus K. Beaver, Jephtha H. Rucker and Henry H. Linton.

## ILLINOIS.

**Aurora**—A syndicate for the construction of another electric railway has been formed, and the following named gentlemen are interested: Senator H. H. Evans, and Messrs. F. L. Pond, Fay Winslow, T. N. Holden, Will George, W. B. Miller and John Plain.

**Chicago**—The Day Elevated Ry. Plant Co. has been incorporated with a capital stock of \$5,000,000, for the purpose of buying up the patents of St. John Day an English engineer, which which patents call for an entirely new system of elevated roads and appliances therefor. The following named gentlemen are the incorporators of the company: Geo. H. Simmons, St. John F. Day, Wm. T. Block.

The Chicago, Blue Island & Harvey St. R. R. Co. of this city has been incorporated with a capital stock of \$250,000. Messrs. E. H. Rexford, A. Reimer and O. McCalmont are interested.

The Love Electric Traction Co. of this city has been incorporated with a capital stock of \$10,000,000 to build electric railways and appliances. Incorporators are Homer N. Hibbard, Alfred G. Wheeler and John C. Love.

The Morgan Park Elec. Co. of this city has been incorporated for the purpose of furnishing electric light, power and heat; the capital stock \$25,000, and the incorporators are: Geo. A. Meech, J. H. Westover and F. S. Wheaton.

## INDIANA.

**Brazil**—A strong effort is being made to promote a street railway here and it only needs a little incentive from outside parties to bring the matter to a climax.

**Laporte**—Messrs. Snow and Avery of Detroit have been granted a franchise for an electric railway here.

**Paru**—An electric street Ry. will be built here the immediate future.

## IOWA.

**Clinton**—The Baldwin Electric Light Co. has been granted an exclusive franchise for five years to build an electric street railway here, paralleling the old horse car lines.

## KENTUCKY.

**Paducah**—A new company is trying to obtain possession of a franchise here for another line of electric railway.

## MICHIGAN.

**Ionia**—Enterprising capitalists could readily obtain a street railway franchise at this point.

## NEW JERSEY.

**Englewood**—It is very likely that an electric railway through this village will be built in the immediate future.

## NEW MEXICO.

**Albuquerque**—An electric railway to the Mesa is now a sure thing.

## NEW YORK.

**Saratoga**—The Union Electric Ry. Co. of this city, capitalized at \$300,000, has been incorporated for the purpose of building an electric railway five and one-half miles long.

A list of the directors will be found under the head of "Elections" in this issue.

The Saratoga Rapid Transit Co. has been incorporated for the purpose of building a road 2½ miles long. The capital stock of the company is \$30,000, and a list of the directors will be found under the head of "Elections" in this issue.

## OHIO.

**Cleveland**—The Woodland Electric Co. capitalized at \$30,000, has been incorporated by Alfred Arthur, Kate S. Arthur, Howard F. Loomis, Ada A. Burnham and Isaac A. Richman, for electric light and power purposes.

## ONTARIO, CANADA.

**Toronto**—The Weston High Park & Toronto St. Ry. Co (limited), capitalized at \$100,000, has been incorporated.

**Preston**—The Gault & Preston St. Ry. Co. (limited), capitalized at \$50,000, has been incorporated.

## PENNSYLVANIA.

**Reading**—The Reading & South Western Elec. R. R. Co., capitalized at \$130,000, has been incorporated, with Henry N. Adams of this city as President.

**Uniontown**—An electric railway is to be built here in the immediate future.

## TEXAS.

**Gainesville**—The Board of Trade has raised \$60,000 in stock and secured two charters for a new railroad here.

## VIRGINIA.

**Danville**—Arrangements have been completed for the construction of a street car line in North Danville, and a company has been incorporated for that purpose.

## WISCONSIN.

**Racine**—The Peoples St. Car Co., capitalized at \$150,000, has been incorporated by F. G. Bull, W. P. Dutton and B. B. Blake.

The Belt City line has an exclusive franchise for 25 years, but the incorporators of the new company claim that the old one has forfeited the franchise.

## ELECTIONS.

**Biddeford, Me.**—The following named gentlemen have been elected as officers and directors of the Biddeford and Saco Horse R. R. Co., for the ensuing year:

Pres.—Esreff H. Banks.

Treas.—C. H. Prescott.

Directors.—Charles B. Pratt and Harry S. Seeley, of Worcester; Esreff H. Banks, Joseph Gooch, John F. Nourse and G. H. Prescott of Biddeford; Stephen S. Mitchell, Franklin Nourse and George F. Calef of Saco.

**Boston, Mass.**—The following named Board of Directors of the West End St. Ry. Co., has been elected: Henry M. Whitney, Elisha S. Converse, Isaac T. Burr, Charles O. Foster, Eustace C. Fitz, Samuel Little, E. D. Jordan, Henry D. Hyde, Asa P. Potter, Joseph S. Fay, Jr., Dexter N. Richards, Edmund Reardon, G. T. W. Braman, Nelson Bartlett, Jonas H. French.

**Brooklyn, N. Y.**—The West Brooklyn & Bath Beach Elec. Ry. Co., has elected the following officers for the ensuing year:

Pres.—Andrew D. Baird of Brooklyn.

Vice Pres.—Captain Richard Hawley of West Brooklyn.

Sec.—William P. Rae of Brooklyn.

Treas.—Allen N. Spence of West Brooklyn.

**Decatur, Ill.**—Mr. John W. Alexander has been appointed manager of the Decatur Electric St. Ry. Co. vice Mr. Guy Parke, resigned.

**Denver, Col.**—The following named gentlemen are the officers of the Denver, Lakewood & Golden R. R. Co., of this city:

Pres.—Wm. B. Willard.

Vice Pres., and General Manager—J. W. Starkweather.

Treas.—J. P. Haynes.

Sec. and Attorney.—H. J. Hersey.

Directors, officers and Robt. Ryan.

**Grand Rapids, Mich.**—At the recent annual meeting of the Crystal Springs Street R. R. Co., the old Board of Directors was re-elected, with the exception of Col. H. B. Jackson, who resigned and whose place was filled by Mr. Thomas Friar, the old officers were likewise re-elected.

**Haverhill, Mass.**—Mr. Ira O. Sawyer has been re-elected President, and Mr. John A. Colby Clerk and Treasurer of the Haverhill & Groveland St. Ry. Co.

**Jamestown, N. Y.**—The officers and directors of the Citizens St. R. R. Co., of this city are as follows:

Pres.—Philip A. Templeton.

Vice-Pres.—John Cowles.

Treas.—F. A. Bentley.

Sec.—F. P. Cordullos.

Financial Agent and General Manager.—I. W. Newcomer.

Attorneys.—Bootey, Fowler & Weeks.

Directors.—P. A. Templeton, F. A. Bentley, Edward R. Booty, John Cowles, J. B. Flisher, William Hjorth, I. W. Newcomer.

**Kansas City, Mo.**—Mr. W. B. Kelley, formerly Superintendent of the Rosedale Division of the Metropolitan St. R. R. Co., has been appointed Superintendent of the Fifth Street Cable line vice John Patterson, deceased.

**Lincoln, Neb.**—The Lincoln City Electric Ry. Co., has elected the following Board of Directors to serve until the annual meeting next year: George E. Bigelow, L. C. Humphrey, D. L. Prace, J. G. Southwick and G. A. Bush. The stockholders are: H. C. Palmer, Grant A. Bush, David L. Brace, L. C. Humphrey, George E. Bigelow and J. G. Southwick.

**Lowell, Mass.**—The Lowell and Pricott St. Ry. Co., has elected the following Board of Directors: August Fels, Percy Parker, S. B. Puffer, John Lennon, Frank W. Howe, Miles F. Brennan, P. F. Sullivan.

**Mahanoy City**—The following named gentlemen have been elected as officers of the Mahanoy City Electric Railway:

Pres.—C. D. Kaier.

Vice-Pres.—M. M. MacMillan.

Sec'y.—M. Litsch.

Treas.—A. W. Brown.

**Milwaukee, Wis.**—The following named gentlemen have been elected as officers and directors of the Milwaukee City Railroad company:

Pres.—Howard C. Payne.

Manager.—Geo. W. Honnel.

Sec'y and Treas.—Edward Hedges Connell.

Asst. Sec'y and Treas.—Geo. O. Wheatcroft, of Milwaukee.

Directors.—Henry C. Payne, Milwaukee; David S. Wegg, Chicago; Wm. Nelson, Cromwell, N. Y.; Chas. A. Spofford, Chas. W. Wetmore, W. J. Curtis, G. Ulbricht, New York.

**New York, N. Y.**—At a meeting of the stockholders of the Third Ave. R. R. Co., the following named gentlemen were duly elected as directors:

Henry Hart, William Remsen, Lewis Lyon, R. G. Remsen, William M. Pritchard, Silvanus S. Ricker, Robert W. Taylor, John E. Parsons, Edward Lauterbach, Solomon Mehrback, Albert D. Rosenbaum, Albert J. Elias and Alexander Nones.

The following named gentlemen have been elected as officers and directors of the Suburban Rapid Transit Co., for the ensuing year:

Pres.—J. Hood Wright.

Sec. and Treas.—L. W. Pomeroy.

Supt.—E. B. Whitmore.

Directors.—J. Hood Wright, J. Pierpont Morgan, Samuel Spencer, George Bliss, Charles Lanier, John H. Hall, Jay Gould, Cyrus W. Field and Russell Sage.

**Pottsville, Pa.**—The following named gentlemen have been elected as directors of the electric railway here, to serve until the regular election in January: C. D. Kaier, A. W. Brown, D. J. Cleary, W. E. Jones, Maurice Litch, W. F. Richardson, N. Huber, M. MacMillan, R. Littlehales, G. W. Seligman and G. C. Irish.

**Saratoga, N. Y.**—The following named gentlemen constitute the Board of Directors of the Saratoga Rapid Transit Ry. recently incorporated,



and references to which is made under the head of "New Enterprises" in this issue: G. W. Morton, George I. Humphrey, L. H. Cramer, Saratoga; Myer Nussbaum, Henry Russell, Charles E. Arnold and Edward J. Slattery, Albany.

The following named gentlemen have been elected as officers and Board of Directors of the Union Electric Ry. Co., of this city, recently incorporated, particulars of which are given under the head of "New Enterprises" in this issue:

Pres.—Ex-Senator Henry Russell of Albany;  
Vice-Pres.—Charles E. Arnold, of the Commercial Union Telegraph company of Albany.  
Sec.—George I. Humphrey.  
Treas.—E. J. Slattery, of Albany.  
Chief Engineer.—L. H. Cramer.  
Counsel.—John L. Henning.

Executive Committee.—President, Vice-president and Messrs. L. H. Cramer, G. I. Humphrey and E. J. Slattery.

Directors.—Henry Russell, Charles E. Arnold, Edward J. Slattery, Clifford D. Gregory, Henry L. Smith, Myer Nussbaum, A. J. Voyer, Albany; W. J. Arkell, Canajoharie; L. H. Cramer, Geo. I. Humphrey, William Hay Brocker, J. Willard Lester, C. S. Grant, Saratoga.

**Schenectady, N. Y.**—The new officers of the Schenectady St. Ry. Co., recently purchased by the Edison General Co., are as follows:

Pres.—John Kreusi.  
Sec'y and Treas.—W. E. Gilmore.  
Superintendent—William Turner.

**Scranton.**—The following named gentlemen have been elected as directors of the Peoples Street Railway company for the ensuing year: Lathrop R. Bacon, R. T. McCabe, C. Weidenfeld, Thomas H. Thomas, W. W. Sherman, of New York; P. S. Page, W. W. Winton, J. Alton Davis and W. H. Jessup, Jr., of Scranton.

**Whitman Mass.**—The following named gentlemen have been elected as officers and directors of the Whitman Electric Ry. Co., for the ensuing year:

Pres.—G. O. Jenkins.  
Treas.—F. C. Hayward.  
Clerk—C. D. Nash

Executive Board.—G. E. Hersey, H. H. Jenkins, G. O. Jenkins, F. C. Hayward, C. D. Nash.

## EXTENSIONS.

**Brockton, Mass.**—The East Side Elec. St. Ry. company of this city has applied for a franchise to extend its line to North Easton.

**Duluth Minn.**—The St. Ry. company here will extend its lines to Lester Park next year.

**Jersey City, N. J.**—The Jersey City and Bergen Electric company is extending its electric lines.

**Ocala, Fla.**—The Ocala St. & Suburban Ry. has filed amended charter by which it is authorized to extend its lines to and through other suburbs of this city.

**Reading, Pa.**—The East Reading Elec. Ry. company will build an extension of its line two miles in length to Stony Mill Woods.

**Spokane Falls, Wash.**—The Lidgerwood Electric line is to be extended into Lidgerwood Park.

**Washington Heights, Ill.**—The Calumet Electric Ry. company has been granted a franchise to build through this village, and we understand that the lines are to be extended to Western avenue, on 95th street, with a branch through Fernwood and Morgan Park.

## FOREIGN TRAMWAY NEWS

### AUSTRIA.

**Brux.**—A tramway line is projected to Oberleutensdorf.

**Carlsbad.**—An electric railway line is under consideration.

A franchise has been applied for to build a local electric street railway.

**Linz.**—The local tramway has been completed and opened to business.

**Salzburg.**—The Salz Kammergut Localbahn Actien Gesellschaft has been organized with a capital of 1,600,000 florins to build and operate tramway lines.

**Vienna.**—The Wiener Tramway Gesellschaft has declared an annual dividend of 4 per cent.

The Wiener Tramway Gesellschaft has applied for permission to build 25 kilometres more of track and operate two new electric underground lines. Estimated cost, 4,000,000 gulden.

Three new local tramway projects are being considered by the authorities.

The Wiener Tramway Gesellschaft is considering the question of a more rapid transit.

**Weinberge.**—A local company has been formed to build a street car line to Prague.

### BELGIUM,

**Brussels.**—A syndicate has been organized with a capital of 4,000,000 francs to construct a local tramway line in Damascus, Turkey.

The Compagnie centrale des chemins de fer et tramways en Espagne has been organized to operate enterprises in Spain; capital 200,000 francs.

A syndicate of local capitalists has been organized to build a tramway line in Adrianople.

The project of a local tramway seven kilometres long, to be built by the city of Brussels and adjacent towns is meeting with considerable encouragement.

**Antwerp.**—The Antwerpener Tramway Gesellschaft has found such a formidable rival in a local omnibus company that its business has been seriously affected.

### FRANCE.

**Lyons.**—The Compagnie Lyonnaise des tramways et chemins de fer reports its electric line a complete success.

### GERMANY.

**Aachen.**—The Aachen-Burtscheider Pferdebahn it is reported will reduce its capital stock from 1,600,000 to 800,000 marks.

**Aussig.**—Application for permission to build a local tramway has been made to the authorities.

**Barmen.**—The Barmer Trambahn has declared a dividend of 4.50 marks for 1890.

The Barmer Trambahnen reported its earnings for 1890 at 747,724 francs.

**Berlin.**—The Neue Berliner Pferdebahn Gesellschaft shows an income for September of 141,679.95 marks.

The Berliner Pferde Eisenbahn Gesellschaft reports its earnings for September as being 67,856.48 marks.

The Grosse Berliner Pferde Eisenbahn Actien Gesellschaft places its September earnings at 1,179,573.62 marks.

The Neuen Berliner Pferdebahn Gesellschaft will have their Weisensee line completed by next July.

The Grossen Berliner Pferdebahn contemplates opening up several new lines in the near future.

**Bonn.**—The projected tramway line to Poppelsdorf is beginning to assume a tangible shape.

A franchise has been granted for a tramway line to connect this city with Godesberg, Mehlem and Rolandseck.

**Braunschweig.**—The earnings of the Braunschweiger Strassenbahn for August are placed at 25,145 marks.

**Breslau.**—The income of the Breslauer Strassen Eisenbahn for September is placed at 85,046 marks.

**Bretzenheim.**—Work on the Bretzenheimer Dampf Strassen Bahn is being vigorously pushed forward.

**Brunn.**—The Brunner Local Eisenbahn has declared an annual dividend of 4 per cent.

**Budweis.**—The Budweiser tramway company has applied for six months extension on their concession to build a local line.

**Bulach.**—A company has been formed to build an electric tramway to connect with Beiernheim.

**Carlsruhe.**—A project is on foot to build an electric tramway to connect this city with Muhlberg, Neureuth and Eggenstein.

**Cassel.**—The Casseler Strassenbahn has declared an annual dividend of 13/4 per cent. 1890.

The passenger traffic of the Casseler Strassenbahn Gesellschaft yielded 21,256 marks for September.

**Chemnitz.**—The Allgemeine Elektrizitats-Gesellschaft of Berlin has acquired a controlling interest in the tramway here, operated by the Deutscher Local und Strassenbahn Gesellschaft.

**Cologne.**—The passenger traffic of the Colnische Strassenbahn Gesellschaft yielded 67,856.48 for September.

**Dresden.**—Several new street car enterprises are under consideration here.

**Durlach.**—The Vereinigte Karlsruher-Muhlburger und Durlacher Pferde und Dampfbahn Gesellschaft earned 20,113 marks during September.

**Elberfeld.**—The estimated cost of the Elberfeld-Barmen electric street railway line is placed at 6,000,000 marks.

**Essen.**—A street car line is projected to connect this city with Altendarrf, Altenessen, Borbeck and Ruttenscheidt.

Work on the local street railway line is progressing rapidly.

**Fichtelberg.**—Work on the Neusorg-Fichtelberg Trambahn is being pushed forward to completion.

**Forchheim.**—Work is progressing rapidly on the Forchheim Ebermannstadt Tramway Line. It will in all probability be completed by June next.

**Frankfurt.**—The earnings for September are represented by 136,324 39 marks.

**Friedrichshagen.**—The projected street car has taken definite shape. The contract for its construction has been let and work will be pushed forward to completion.

**Furth.**—Work on the Zirndorf-Furth tramway is being rapidly pushed forward.

**Garlitz.**—Rapid progress is being made in the construction of the Garlitzer Pferde-eisenbahn.

**Gotteszell.**—A Munich company with a capital of 1,500,000 has been organized to build a tramway line from this place to Viechtach.

### SWITZERLAND.

**Berne.**—A project is on foot to build an electric street railway to Sissach and Gelterkinden. The Tramway Bern has been completed and will soon be opened for business.

**Birsigthal.**—The Birsigthal Bahn places its September income at 15,032 francs.

**Graubunden.**—A local tramway is projected by Basle and Zurich capitalists.

**Luzerne.**—A project is on foot to build a local street car line. It has met with great favor.

**St. Gall.**—A new tramway line is projected to Bruggen and Weid.

**Zurich.**—The trial trip of the electric street railway line proved a success.

The Zurich Strassenbahn reports 35,410 francs as its earnings for September.

### TURKEY.

**Adrianople.**—A Belgian syndicate will build a local tramway 98 kilometres long.

**D. mascus.**—A street railway line will be built by a syndicate of Belgian capitalists.

## TOO LATE TO CLASSIFY.

**Atlanta, Ga.**—Mr. W. A. Hemphill has resigned the presidency of the Atlantic Street Ry. company, having disposed of his stock to Mr. J. W. Culpepper. Mr. A. E. Thornton has been elected to succeed him.

**Carthage, Mo.**—The Carthage and Twin Cities electric railway and power company has been incorporated with a capital stock of \$150,000, half paid up. The object is to build and operate a street Ry. in this city and extend to Webb City, a distance of nine miles. They will acquire possession of the Carthage street railway and build six miles in the city. The incorporators are Major H. H. Harding, Major W. B. Meyers, C. O. Harrington, C. D. Sleeper, Charles N. Reynolds, Al Cahn and Joseph Herrin.



**Eau Claire, Wis.**—The power house of the Street Railway Light and Power company here, burned out on the 2nd inst. with a loss of about \$25,000, mostly covered with insurance however.

**Griffin, Georgia.**—The Griffin Street Ry. company is now organized under charter, with J. G. Rhea, cashier of the City National bank, of Griffin, as president. The company will build two miles of road at once; and is in the market for rails, cars, etc.

**Indianapolis, Ind.**—The Crown Point & Indiana Stockyards street railway company has been incorporated with a capital stock of \$25,000, and the directors are J. W. Youche, William Krimbill, Mathias Boney, Frank Seeberger, and John E. Luther; the road is to connect the town of Crown Point with the new stockyards plant about to be erected near there, and also with Cedar Lake; the motive power used will probably be electricity.

**Newark, N. J.**—The Newark & Passaic Ry. company has increased its capital stock from \$40,000 to \$200,000.

**Oberlin, Ohio.**—The Oberlin street railroad company has been incorporated with a capital stock of \$20,000.

**Syracuse, N. Y.**—The People's Railroad company has decided to issue bonds to the amount of \$750,000, in order to completely finish and operate its various branches. The corporate property and franchises will be mortgaged in order to secure the payments of the bonds and interest. The bonds will be of \$1,000 each, payable in 30 years and bearing 5 per cent. interest, payable annually.

**Whitinsville, Mass.**—The Whitinsville street railway company has been incorporated for the purpose of constructing a street railway between the village of Whitinsville, in the town of Northbridge, and Whitinsville station on the Providence & Worcester railroad, one and a half miles. The capital stock is \$20,000. Chester W. Lasell, Robert K. Brown, William L. Taft, G. M. Whitin, Cyrus A. Taft, William E. Johnson, Josiah M. Lasell, directors.

#### Married.

LEONARD—TROMANHAUSER.

At 5 o'clock in the afternoon of Thursday, the 4th inst., Mr. John M. Leonard, managing editor of the *Minneapolis Tribune*, and Miss Olive M. Tromanhauser, late of St. Mary's, Ont., were very quietly married by Rev. J. J. Faude, pastor of Gethsemane church, at the residence of the bride, 2313 Fifth Avenue, South Minneapolis. Mr. John Fritsche acted as best man, and Miss Hattie Tromanhauser, (sister of the bride,) as bridesmaid.

We extend our most hearty congratulations to our brother in the editorial chair, and venture to express the belief that the bright influence which he has now caused to be exerted over his life will be the means of making his arduous official duties mere matter of delight and pleasure throughout the future. Mrs. Leonard is a woman of rare literary ability, and will undoubtedly prove herself what woman was originally intended to be—a fitting help-mate for her husband. Our ever good wish is theirs.

BOWIE—BENNETT.

On Wednesday, Nov. 19th, at high noon, at the residence of the bride in Weston, W. Va., Mr. W. Duekell Bowie of Baltimore, a heavy stockholder in many of the street railways in that city, and Miss Mary L. Bennett, daughter of the late Hon. John Bennett, of West Va., were married by Dr. T. H. Lacy. Mr. Odin Bowie Jr. acted as best man, and the Hon. W. G. Bennett's little daughter Bertha as maid of honor. The newly married couple left for New York on Gov. Bowie's private car, and sailed to Europe to spend the honeymoon, taking with them the best wishes of the GAZETTE.

MC KINLOCK—RAPPLEYE.

On Dec. 2, Mr. Geo. A. McKinlock, Treasurer of the Central Electric Company of Chicago, and Miss Marion Rappleye were married at the residence of the bride, 3636 Prairie Avenue, Chicago.

One of the wedding presents consisted of a magnificent set of silverware of 89 pieces, the gift of the Okonite Company.

The newly married couple sailed for Europe on the Etruria, where they will spend the next twelve months.

Mr. McKinlock is very widely known in the electrical field, and the GAZETTE extends to him and his bride its hearty congratulations, and good wishes.

#### Obituary.

WILLIAM B. KNIGHT.

Mr. W. B. Knight, whose sad death from injuries received in the Wabash-Alton railway collision, on Thursday, Dec. 4th, occurred at 6.40 p. m., on Dec. 6th, had a remarkably active and useful career.

He was born in New York city, June 15, 1848, and his youth was spent in that city, where he received his early education. He learned civil engineering at the Rensselaer polytechnic institute, Troy, N. Y., and his first active work in the profession was in connection with the Hudson Highland suspension bridge. In 1868 he was engaged in the survey division of Westchester county, N. Y., and in 1869 was employed on the preliminary survey of the Poughkeepsie & Eastern railroad, and as chief engineer in charge of the highway surveys on Staten Island. The next engineering work of importance with which he was connected, was the building of the New Haven, Middleton & Willimantic railroad, in Connecticut, where he was engaged as assistant engineer. For the next three years his time was devoted almost entirely to railroad engineering, he being engaged during that time on the Brunswick & Albany railroad in Georgia, the South Florida railroad, the New York, West Shore & Chicago railroad and the New York Central & Hudson River railroad. In September, 1874, he accepted a position with the board of public works of Washington, D. C., where for a year he was engaged in constructing the main sewer system of that city and the laying out of new streets.

In October, 1875, he was with the Lake Erie, Evansville & Southwestern railroad as chief engineer. In 1876 he was employed in the department of public parks, New York city, on sewer work, and in 1877 was appointed city surveyor of New York. From February, 1878, to August, 1879, Mr. Knight was in the service of the Panhandle Railroad company as assistant to the general superintendent in the operation and management of the road.

In the fall of 1879 he went to Kansas City, and associating with him Mr. Daniel Bontecou, established the civil engineering firm of Knight & Bontecou, which soon came to be regarded as one of the leading engineering firms in the West. While a member of this firm Mr. Knight laid out the Union Transit company's line (now part of the Belt line) and was engaged on the improvement of terminal facilities for the Kansas City, Fort Scott & Memphis Railroad company. During 1880 and 1881 Mr. Knight was engaged in much important engineering work, chief among which was the construction of the Arkansas City canal at Arkansas City, Kan. In April, 1882, he was appointed city engineer of Kansas City by Mayor Bullene, and was reappointed in 1883 and 1884, serving three years in all. From 1884 to the present time Mr. Knight was chiefly engaged in cable line building in Kansas City, having been for several years the chief engineer of the Metropolitan system. Mr. Knight designed and constructed the Twelfth street, Fifth street and Eighteenth street lines of the Metropolitan company, as well as the Main street loop, which is regarded as a remarkable piece of engineering. In 1887 he was appointed chief engineer of the Kansas City Belt railway, and built the double tracks of that line. His latest engineering work was in connection with the Kansas City Circular railway, of which he was the designer and chief engineer.

Mr. Knight had a national reputation as one of the leading engineers of the country. In 1874 he was elected a junior of the American Society of Civil Engineers, and was made a full member in 1879. He was elected a member of the Civil Engineers' Club, of St. Louis, in 1886, and at the organization of the Kansas City Engineers' Club in 1887, he was elected as its first president and was re-elected in 1888.

Mr. Knight, at the time of his decease, was also general manager of the Patton Motor Manufacturing Co., of Chicago, and was very highly esteemed by all who were fortunate enough to know him.

Mr. M. M. Wood, formerly District Electrical Engineer, of the General Edison Electric company, in Portland, Ore., is now attached to the engineering corps of the Electric Supply company of Chicago. Mr. Wood has had an extensive experience in both electric lighting and railroading matters, and will certainly find a constant and growing field for action with the pushing concern with which he is now associated.

Mr. Allan V. Garratt, who has been making a trip West, through the Rocky Mountains, paid us a visit lately, en route East.

We understand that a large order—aggregating something like 100 cars—has been secured for the electric heater illustrated in the November issue of the GAZETTE.

#### Supplementary and Emergency Brake.

Mr. C. Challenger, traffic manager of the Bristol Tramways and Carriage company, limited of Bristol, England, has designed and patented a supplementary and emergency brake. The principal points of merit for which are:

1. An automatic brake-catch.
2. A duplication of the ordinary horse-car brake.

3. A combined spindle-socket and catch-bolt plate, giving a definite and uniform position to the ratchet wheel catch, and extra strength and security to the whole.

4. The bolt on which the ratchet-wheel catch works is extended upwards and secured by a thread and nut to the top rail of the dash-guard, including the top spindle-socket. This effectually puts an end to loose catch-bolts, so annoying and dangerous to drivers.

5. The brake may be used in preference to the ordinary one on arriving at the terminus, as by its use, the catch applying automatically there is no possibility of the brake flying off suddenly, and injuring passengers who may be passing on or off the car at the moment.

6. Very little, and in most cases, no alteration of the existing brake mechanism is required for the purpose of affixing this brake.

The brake has been subjected to some very severe tests abroad, and according to all accounts is likely to come into general use.

#### Business Notes.

Under date of Nov. 10th, Chadbourne, Hazelton & Co., of Philadelphia, Pa., send us the following:

When we took the agency for the United States for the Wenstrom Consolidated Dynamo & Motor Co., last June, it was the intention of that company to equip its old factory at Locust Point, Baltimore, with new machinery. It determined however, later, to build a new factory, purchased 100 acres of ground for that purpose, and commenced operations. The opening of the new factory has been somewhat delayed, owing to the extremely rainy season, and there is such a demand for Wenstrom apparatus that it is entirely unable to fill its orders with its old facilities.

At a recent meeting of the directors, the situation was discussed, and in order to hasten matters, the Wenstrom Co., has rented a larger factory in Baltimore, already equipped with boilers, engines and shaftings. It is 60 feet front, 260 feet deep and three stories high, and will be in working order by the last of this month. The company expects to be able to turn out enough machines here, by working day and night, to fill its most pressing orders, and in the mean time will push to completion its large new factory at Calverton, which will be ready for operation by the early spring to meet the spring trade and the demand for street railway apparatus, to which this new factory will be almost entirely devoted; this will give the Wenstrom Co. as good facilities as any company in the country, and by the first of the year it will be able to fill all orders on time.

Mr. W. A. Stadelman, who has for some time been connected with the firm of Chadbourne, Hazelton & company, of Philadelphia, has recently severed his active interest in that concern, and has reorganized the Equitable Electric Railway Construction company, of which he was chief engineer, and will devote his entire energies to the new concern.

The new company will be known as the Equitable Engineering and Construction company, and a new charter will be applied for which will give the company the right to not only equip, Electric railways, but to buy and sell or lease or operate them.

The old company will go out of business by liquidation, and the new company will take its place.

Handsome new offices in the Drexel building have been taken, and the new company has already several important contracts; one for an electric railway in the South, and one near Philadelphia for a complete central station, alternating current lighting plant, including engines, boilers, buildings, etc.

The capital of the new company is \$50,000, and a list of its officers will be found under the head of "Elections" in this issue.



## Patents.

The following is a complete list of such patents as relate to street railway interests, issued between Aug. 12 and Nov. 11, 1890. Especially prepared for the STREET RAILWAY GAZETTE by Messrs Higdon & Higdon, Solicitors of Patents and Trade-Marks, room 36, LeDroit building, opposite U. S. Patent Office, Washington, D. C. A printed copy of any patent here named will be furnished by them for 25 cents (stamps).

*Issue of August 12, 1890.*

- 434,172. Tram-car, Cyrus W. Baldwin, Yonkers, N. Y.  
 434,181. Device for Adjustment and Testing of Electric Cars, Theodore M. Foote, Boston, Mass.  
 433,982. Car Starter, Charles W. Hall, Lyons, Iowa.  
 434,109. Coin Freed or Actuated Machine, Anthony Harris, Middlesborough, County of York, England.  
 433,941. Aerial Railway Transit, Wallace L. Hight, Boston, Mass.  
 434,390. Electric Railway, Rudolph M. Hunter, Philadelphia, Pa.  
 434,147. Electric Railway, Electric Car Co. of America, Philadelphia, Pa.  
 434,030. Electric Railway, Thomson-Houston Electric Company, Boston, Mass.  
 434,148. Electrically Propelled Vehicle, Thomson-Houston Electric Company, of Connecticut.  
 434,275. Electric Railway Thomson-Houston Electric Company, of Connecticut.  
 434,389. Electric Railway, Thomson-Houston Electric Company, of Connecticut.  
 434,391. Electric Railway, Thomson-Houston Electric Company, of Connecticut.  
 434,063. Brake Mechanism for Electric Street Cars, Joshua Illingworth and A. M. Baker, Cleveland, Ohio.  
 434,087. Electric Rail Connector, Charles A. Lieb, New York, N. Y.  
 434,206. Armature for Dynamos, Westinghouse Electric Company, Pittsburg, Pa.  
 434,034. Support for Car Motors, Sidney H. Short, Cleveland, Ohio.  
 434,096. Rotating Part of Dynamos and Motors, Sperry Electric Company, of Illinois.  
 434,213. Metallic Railway Tie, Hiram Taylor, Northampton, and D. E. Sherman, Springfield, Mass.  
 434,036. Trolley for Electric Railways, Joseph H. Wehrle, Newark, N. J.  
 434,140. Gripper for Traction Rope Railways, George Whittaker, assignor of one-half to O. L. Gardner, Brooklyn, N. Y.  
 434,011. Vertically Adjustable Dynamo Support, Thomas Wrigley, Oak Park, assignor of one-half to F. B. Badt, Chicago, Ill.

*Issue of August 19, 1890.*

- 434,420. Street Railway Track, Charles A. Beach, Albany, N. Y.  
 434,554. Sinuous Pleasure Railway, Hermann Bormann, Philadelphia, Pa.  
 434,579. Apparatus for Transferring Electric Car Batteries, Frederick G. Corning, New York, N. Y.  
 434,580. Apparatus for Transferring Electric Car Batteries, Frederick G. Corning, New York, N. Y.  
 434,581. Apparatus for Transferring Electric Car Batteries, Frederick G. Corning, New York, N. Y.  
 434,582. Mechanism for Transferring Electric Car Batteries, Frederick G. Corning, New York, N. Y.  
 434,863. Apparatus for Transferring Electric Car Batteries, Frederick G. Corning, New York, N. Y.  
 434,589. Propelling Mechanism for Electric Vehicles, Thomas A. Edison, Llewellyn Park, N. J.  
 434,827. Electric Railway, Adelos Gorton, Camden, N. J.  
 434,871. Electric Railway, Electric Car Company of America, Philadelphia, Pa.  
 434,573. Cable Gripper and means for carrying the same over crossing cables, James B. Morris, assignor of one-half to W. H. Williams, Chester, Pa.

- 434,527. Car Omnibus, Russell Street Carette Company, Chicago, Ill.  
 434,726. Car Omnibus, Russell Street Carette Company, Chicago, Ill.  
 434,682. Trolley for Electrically Propelled Cars, William L. Stevens and E. J. Wescott, Boston, Mass.  
 434,684. Electric Railway System, Charles J. VanDepoele, Lynn, Mass.  
 434,685. Alternate Current Electric Railway Train System, Charles J. VanDepoele, Lynn, Mass.

- 434,686. Electric Railway Train System, Charles J. VanDepoele, Lynn, Mass.  
 434,687. Electric Railway System, Charles J. VanDepoele, Lynn, Mass.  
 434,816. Multiple Circuit Electric Motor, Charles J. VanDepoele, Lynn, Mass.  
 434,692. Street Railway Switch, B. F. Barnard, Wakefield, Mass.

*Issue of August 26, 1890.*

- 435,166. Trolley or Contact Support for Electric Cars, Leonard Atwood, Philadelphia, Pa.  
 435,011. Trolley for Electromotor Cars, D. J. Whelan, W. J. Roche, and T. J. Quinn, Troy, N. Y.  
 435,015. Dynamo Electric Machine, William F. Collins, New York, N. Y.  
 435,296. Contact Brush for Dynamos, Eugene Franklin, Greenville, S. C.  
 435,097. Electric Signal for Cable Railways, Solomon J. Jacobs, New York, N. Y.  
 435,020. Compressed Air Street Car Motor, Frank M. Merrill, Oakland, Cal.  
 434,993. Motor for Street Cars, Patton Motor Company, Pueblo, Colo.  
 344,949. Gearing for Electrically Propelled Vehicles, Nathan S. Possons, Cleveland, Ohio.  
 435,263. Electric Railway Conduit with Tubular Conductor, Charles J. VanDepoele, Lynn, Mass.

*Issue of Sept. 2, 1890.*

- 435,640. Means for Supporting Storage Batteries on Railway Cars, Harry H. Blades, Detroit, Mich.  
 435,641. Electric Railway Car, Harry H. Blades, Detroit, Mich.  
 435,639. Electric Motor, Detroit Motor Company, Detroit, Mich.  
 435,642. Electric Railway Car, Dewey Corporation, Syracuse, N. Y.  
 435,559. Upward Pressure Contact for Electric Railways, Burnham & Duggan Railway Appliance Company, Quincy, Mass.  
 435,690. Making Armatures for Dynamo Electric Machines, Thomas A. Edison, Llewellyn Park, N. J.  
 435,687. Means for Charging and Using Secondary Batteries, Edison Electric Light Company, New York, N. Y.  
 435,486. Conduit for Electric Railways, William R. Elliott, Kansas City, Mo.  
 435,744. Electric Motor, C. W. Kennedy, Philadelphia, Pa.  
 435,879. Electric Railway, Rudolph M. Hunter, Philadelphia, Pa.  
 435,662. Electric Railway, Thomson-Houston Electric Company of Connecticut.  
 435,427. Station Indicator, Clifford S. Kelsey, New York, N. Y.  
 435,503. Commutator, Charles A. Leib, New York, N. Y.  
 435,504. Commutator, and Making the same, New York, N. Y.  
 435,447. Electric Conductor for Street Railways, Luther M. Perkins, St. Louis, Mo.  
 435,471. Electric Railway Closed Circuit System, Whelless Electric Railway Company, Alexandria, Va.

*Issue of Sept. 9, 1890.*

- 436,125. Electric Lighting and Heating Apparatus for Electric Railways, Dewey Corporation, Syracuse, N. Y.  
 436,127. Electric Motor, Thomas A. Edison, Llewellyn, N. J.  
 436,102. Cable Railway, Rapid Transit Railway Company, New York, N. Y.  
 436,103. Grip Mechanism for Cable Railways, Rapid Transit Cable Company, New York, N. Y.

- 436,104. Cable Railway, Rapid Transit Cable Company, New York, N. Y.  
 436,105. Grip Mechanism for Cable Railways, Rapid Transit Cable Company, New York, N. Y.  
 436,106. Cable Railway, Rapid Transit Cable Company, New York, N. Y.  
 435,982. Regulator for Dynamo Electric Machines, William Stanley Jr., Great Barrington, Mass.  
 435,983. Electrical Traction Apparatus, William Stephens, Santa Rosa, Cal.

*Issue of Sept. 16, 1890.*

- 436,571. Trolley for Electric Railways, David A. Ainslie, Richmond, Va.  
 436,408. Dynamo Electric Machine, Stephen D. Field, Yonkers, N. Y.  
 436,365. Operating Mechanism for Cable Driving Machinery, Gabriel Leverich, South Orange, N. J.  
 436,423. Power Plant for Cable Railways, Gabriel Leverich, South Orange, N. J.  
 436,425. Electric Railway, Hosea W. Libbey, Boston, Mass.  
 436,440. Electric Motor Car, William Robinson, Boston, Mass.  
 436,430. Electric Motor Car, Robinson Radial Car Truck Company, Portland, Me.  
 436,742. Electric Motor Car, Robinson Radial Car Truck Company, Portland Me.  
 436,743. Electric Motor Car, Robinsan Radia Car Truck Company, Portland, Me.

*Issue of Sept. 23, 1890.*

- 437,110. Cable Grip, Elias R. Guerra, Hacienda de San Matias, Jalisco, Mexico.  
 436,955. Traction Cable Grip, James Hird, Goff, Pa.  
 436,874. Electric Contact Device, John J. Hoppes, Springfield, Ohio.  
 437,158. Electric Railway, Electric Car Company of America, Philadelphia, Pa.  
 436,946. Pneumatic Railway, John B. Kelly, Pleasant Home, Oregon.  
 436,923. Electric Railway, Hosea W. Libbey, Boston, Mass.  
 436,805. Fare Register, John H. Rose, Lima, Ohio.

*Issue of Sept. 30, 1890.*

- 437,330. Electric Cable, Electric Cable Construction and Maintenance Company, of Pennsylvania.  
 437,358. Electric Railway System. Charles K. Harding, Atlantic, Ia.  
 437,210. Electric Street Car. J. L. Swearer, Pittsburg, and D. J. Richardson, Allegheny, Pa.  
 437,613. Switch for moving contacts of Electric Railways. John W. Murray, Saginaw, Mich.  
 437,230. Elevated Railway. Henry L. Norcross, Boston, Mass.  
 437,661. Motor Truck for electrically-propelled vehicles. Detroit Electrical Works, Detroit, Mich.  
 437,622. Passenger Fare Collector. J. J. McLoughlin and B. W. Taylor, New Orleans, La.  
 437,623. Passenger Fare Collector. B. W. Taylor and J. J. McLoughlin, New Orleans, La.  
 437,259. Electric Motor Gearing. Joseph J. Sprague, Carthage, Mo.  
 437,534. Upward-Pressure Contact Device for Electric Railways. Charles J. Van Depoele, Lynn, Mass.  
 437,535. Motor Truck for Electric Railway Cars. Charles J. Van Depoele, Lynn, Mass.  
 437,269. Street Car Sleigh. Palmer Wardman and W. Hollister, Sault Ste. Marie, Mich.

*Issue of Oct. 7, 1890.*

- 437,961. Trolley. Thomson-Houston Electric Company of Connecticut.  
 437,832. Electric Motor. Julius Emmer Jr., Washington, D. C.  
 437,993. Gripping Device for Cars for Inclined Railways. Jacob M. Isenberg, Mines, Pa.



- 37,698. Car-Starter. James Sheffield Leach and W. V. Hirst, Rotherham, Eng.
- 37,835. Electric Motor. George Little, Passaic, N.J.
- 37,704. Regulator for Electric Generators and Motors. Robert Lundell, New York, N.Y.
- 37,711. Cable Railway. Cable Motor Traction Company, Newark, N.J.
- 37,720. Conduit Electric Railway. Ernest M. Reed, Witchita, Kans.

*Issue of Oct. 14, 1890.*

- 38,219. Trolley Pole. John M. Anderson, Boston, Mass.
- 38,404. Contact for Overhead Electric Railways. Albert H. Chadbourne, Philadelphia, Pa.
- 38,302. Commutator for Dynamo-Electric Machines. Thomas A. Edison, Menlo Park, N.J.
- 38,359. Trolley Wheel for Electrically-Propelled Vehicles. Louis Pfingst, Boston, Mass.
- 38,192. Electric-Motor. Shawhan Motor Company of Michigan.
- 38,259. Cable Railway. John C. Shelley, Stockton, Cal.
- 38,197. Gearing for Motor Cars. Electric Rapid Transit Company, of New Hampshire.
- 38,293. Electric Railway System. Frank J. Sprague, New York, N.Y.
- 38,564. Electric Railway. F. F. Corless, Boston, Mass.
- 38,204. Electric Motor. Thomson Houston Electric Company, of Connecticut.
- 38,211. Support or hanger for trolley wires. Herbert C. Wirt, Boston, Mass.

*Issue of Oct. 21, 1890.*

- 38,832. Pocket for Fare Conveyors. Arthur A. Anderson, Indianapolis, Ind.
- 38,908. Apparatus for Operating Fare Registers. Reuben O. Belles, Allegheny, Pa.
- 38,602. Alternating Current Generator and Motor. Charles S. Bradley, Yonkers, N.Y.
- 38,603. Electric Motor. Charles S. Bradley, Yonkers, N.Y.
- 38,761. Railway Cable Grip. John W. Gentry, Oakland, Cal.
- 38,070. Electric Railway. Electric Car Company of America, Philadelphia, Pa.
- 38,847. Electric Railway. Thomson-Houston Electric Company of Connecticut.
- 38,069. Electric Railway. Thomson-Houston Electric Company of Boston, Mass.
- 38,009. Station Indicator. Henry E. Jinks, Fenton, Ill.
- 38,928. Pneumatic Railway System. George W. King, Washington, D.C.
- 38,015. Electric Station Indicator. George H. Kirwan, Wilkesbarre, Pa.
- 38,694. Car brake and Starter. Charles J. Luce, Niantic, Conn.
- 38,894. Trolley Switch for Electric Railways. Henry W. Marcy, Utica, N.Y.
- 38,949. Apparatus for transporting loads by means of traveling ropes or cables. John P. Roe, Upper Tooting, Eng.
- 38,650. Switch for Cable Railways. Geo. A. Stafford and A. S. Robinson, Raton, N.M.
- 38,868. Rail Sweeping Attachment for Street Cars. Brooklyn Railway Supply Company, N.Y.
- 37,719. Motor Car. Edmond Verstraete, St. Louis, Mo.

*Issue of Oct. 28, 1890.*

- 38,092. Guide for Trolley Arms. Arthur F. Bardwell, Boston, Mass.
- 38,102. Electric Motor. Charles S. Bradley, Yonkers, N.Y.
- 38,342. Cable Railway. William J. Berwer, New York, N.Y.
- 38,237. Apparatus for Transferring Electric Car Batteries. Frederick G. Corning, New York, N.Y.
- 38,345. Electric Locomotive. Francis W. Dean, Cambridge, Mass.
- 38,597. Conduit for Electric Railways. Thomson-Houston Electric Company of Connecticut.

- 439,354. Mechanism for Operating Street Car Switches. William A. Lee, Peoria, Ill.
- 439,600. Conductor's Fare Box. T. W. Moore Jr., Fairhaven, Wash.
- 439,547. Crossing for Cable Railways. James P. Orr, Pittsburg, Pa.
- 439,182. Trolley Pole. Louis Pfingst, Boston, Mass.
- 439,426. Street Car Crossing. W. Wharton, Jr., and Company, Incorporated, Philadelphia, Pa.
- 439,192. Trolley Pole for Electric Cars. Benton C. Rowell and F. E. Galloupe, Boston, Mass.
- 439,584. Electric Railway Motor Car. J. D. and D. Adams, O. and J. W. Davis, H. G. Allis and J. B. Jones, Little Rock, Ark.
- 439,262. Electric Railway. M. C. G. Westerland, Administratrix, Atlanta, Ga.

*Issue of Nov. 4, 1890.*

- 440,001. Cable-shifting Device for Cable Railway. Rapid Transit Cable Company, New York, N. Y.
- 439,929. Method of and Apparatus for Connecting Dynamos. Charles T. Child, Brooklyn, N. Y.
- 440,016. Automatic Regulator for Dynamos and Motors. Fremont J. Cleaver and G. Fassold, Pittsburg, Pa.
- 439,867. Electric Railway. Dewy Corporation, Syracuse N. Y.
- 439,868. Hose-bridge for Railway-tracks. Thomas H. Donohue and M. Gore, Washington, D. C.
- 439,746. Trolley-line Switch for Overhead Electrical Conductors. William L. R. Emmet, East Rockaway, N. Y.
- 439,941. Street or Station Indicator. Louis Goldstone, San Francisco, Cal.
- 440,106. Adjustable Trolley and Guard for Electrical Wires. Louis S. Hoyt, Boston, Mass.
- 439,662. Electrical Railway. Electric Car Company, of America.
- 439,674. Street or Station Indicator. John C. Murphy, South Evanston, Ill.
- 440,079. Burner for Street-car Lamps. Thomas Wall and R. Sealy, Brooklyn, N. Y.

*Issue of Nov. 11, 1890.*

- 440,584. Shipper for Trolleys. Herbert H. Brooks, Boston, Mass.
- 440,467. Street Car Brake, Joseph C. Chase, New Orleans, La.
- 440,305. Street Railway Switch. Lewis A. Copeland, Providence, R. I.
- 440,398. Brake for Motor Cars. Harry A. Crossley, Cleveland, Ohio.
- 440,424. Dynamo Electric Machine. Walter K. Freeman, Brooklyn, N. Y.
- 440,425. Current Collector for Dynamo Electric Machines. Walter K. Freeman, Brooklyn, N. Y.
- 440,557. Dynamo Electric Machine. Walter K. Freeman, Boston, Mass.
- 440,595. Electric Railway. Thomson-Houston Electric Company, Boston, Mass.
- 440,596. Electric Railway. Electric Car Company of America, Philadelphia, Pa.
- 440,597. Contact Device for Electric Cars. Electric Car Company of America, Philadelphia, Pa.
- 440,189. Electric Motor and Gear. Edgar Peckham, New York, N. Y.
- 440,576. Constructing Underground Conduits. Robert D. Radcliffe, New York, N. Y.
- 440,577. Combined Tunnel and Cable Railway. Robert D. Radcliffe, New York, N. Y.
- 440,502. Electric Railway Switch and Signal Mechanism. Joseph Ramsey Jr. and F. C. Weir Cincinnati, Ohio.
- 440,503. Electric Switch and Cable Mechanism. Joseph Ramsey Jr. and F. C. Weir, Cincinnati, O.

*Issue of Nov. 18, 1890.*

- 440,908. Dynamo Electric Machine and Motor. Frederik V. Andersen and J. O. Gridlestone, London, England.
- 440,686. Electric Railway Car Motor. Thomson-Houston Electric Company, of Conn.
- 440,689. Electric Railway Car. Warren S. Belding, Chicago, Ill.

- 440,821. Electric Motor. Leo Bock Jr. and C. L. Wright, New York, N. Y.
- 440,789. Overhead Conductor for Electric Railways. Robert D. Cushing, Boston, Mass.
- 440,814. Trolley for Electric Railways. Chas. A. Leib, New York, N. Y.
- 440,776. Electric Motor. C. D. Robbins and H. O. Patch, Washington, Pa.
- 441,040. Railway Cable Crossing. Phillip Somerville, San Francisco, Cal.
- 440,665. Trolley Arm for Electric Railways. Elihu Thomson, Lynn, Mass.

*Issue of Nov. 25, 1890.*

- 441,122. Contact Trolley for Electric Railways. Thomson-Houston Electric Co., of Conn.
- 441,123. Trolley for Electric Railway Cars. Thomson-Houston Electric Co., of Conn.
- 441,404. Car Starter. W. H. Forbes, Philadelphia, Pa.
- 441,300. Parcel Carrier for Street Cars. J. S. Hagerty, Baltimore, Md.
- 441,305. Electrically Propelled Vehicle. R. M. Hunter, Philadelphia, Pa.
- 441,565. Electrically Propelled Vehicle. Electric Car Company of America.
- 441,571. Electric Railway. H. W. Libbey, Boston, Boston, Mass.
- 441,572. Electric Railway. H. W. Libbey, Boston, Mass.
- 441,442. Machine for Removing Snow from Railways and Tramways. C. and W. Paulitschky, Vienna, Austria-Hungary.
- 441,377. Grip for Traction Cables. W. Phenix, Chicago, Ill.
- 441,330. Operating Electric Brakes for Electrically Propelled Cars. W. M. Schlesinger, Philadelphia, Pa.
- 441,258. Conduit for Electric Railways. N. Seibert, Malden, Mass.
- 441,455. Step-Box Frame for Cable Railways. J. Walker, Cleveland, O.
- 441,456. Removable Roller Support for Cable Railways. J. Walker, Cleveland, O.

**Expiring Patents.**

The following patents are now public property and may be used by any one.

Manufacturers may determine to what extent they may act independently of Patent Rights, and inventors may gain an insight into the prior state of the art by consulting copies of them.

A printed copy of the drawings and specifications of any of the following will be furnished by Messrs. Higdon & Higdon for 25 cents.

*Expired in Oct., 1890.*

- 143,411. Car Lamp. J. L. Howard.
  - 143,698. Fare Box. T. L. Johnson.
  - 143,837. Car Starter. B. F. Oakes.
  - 143,909. Combined Brake and Starter for Street Cars. C. L. Irving.
  - 143,948. Car Starter, A. Whittemore.
- Expired in November, 1890.*
- 144,260. Car Starter. A. H. Crozier.
  - 144,546. Car Starter. W. A. Jordan.
  - 145,030. Ticket Box. G. C. Thomas.

*Expire during December, 1890.*

- 145,076. Car Starter. V. Wirick.
- 145,468. Car Starter. A. Whittemore.
- 145,760. Car Ventilator. J. D. Simmons.
- 146,112. Car Starter. Wallace & Andrews.
- 146,108. Ticket Box. G. C. Thomas.

The Short Electric Railway company, of Cleveland, Ohio, made the following contracts for the first ten days in December: Pittsburgh & Birmingham Traction Co., Pittsburgh, Pa.; Broadway & Newburgh Street Railway Co., Cleveland, Ohio; Jamestown Street Railway Co., Jamestown, N. Y.

**HARRISON CONVEYOR**

**FOR HANDLING Grain, Coal, Tan Bark, Seeds, Etc.**

Will convey all kinds of grain without mixing. Will carry two different kinds of material in opposite directions at the same time. Will convey One-Hundred and Fifty Tons of Coal per hour. Made of Wrought Iron and Steel. Send for illus. Catalog. **BORDEN & SELLECK CO., 48 and 50 Lake St., Chicago, Ill.**



Electric Railways in North America.

IN OPERATION OR UNDER CONTRACT DECEMBER 1, 1900.

Table with columns: OPERATING CO., LOCATION, SYSTEM, CARS, MILES. The table lists various electric railway systems across North America, including lines in cities like Chicago, New York, Philadelphia, and St. Louis, with details on their operating companies and current status.



















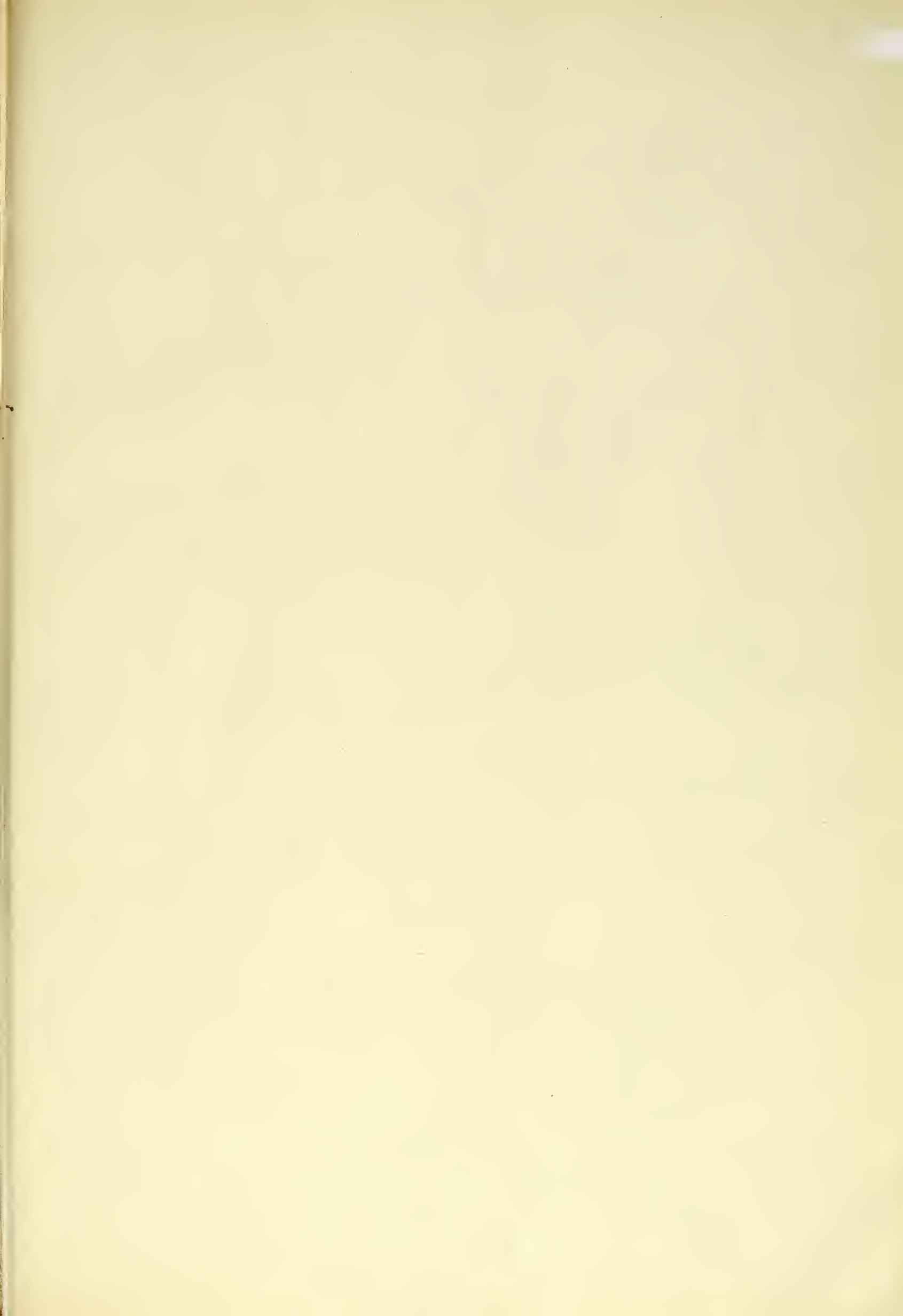











**Date Due**

Date Due		

Lib-26-67





4302

TF  
.E38  
v.5  
1890

SIGN this card and present it with book  
at the CIRCULATION DESK.

MASSACHUSETTS INSTITUTE OF  
TECHNOLOGY LIBRARIES

HUMANITIES LIBRARY



