

T2  
53



[Redacted]

JAN 18 1956

#3

V393  
.R468

**NAVY DEPARTMENT**  
**THE DAVID W. TAYLOR MODEL BASIN**  
**WASHINGTON 7, D.C.**

[Redacted]

**A METHOD OF DETERMINING THE PITCHING AND  
HEAVING CHARACTERISTICS OF SHIPS**

by

M. D. Haskind and I. S. Riman

Issued by

Bulletin de l'Academie des Sciences de l'URSS  
Classe des Sciences Techniques, 1946

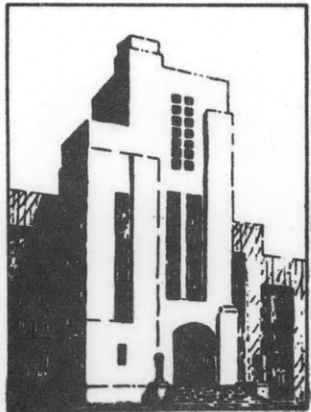

Translated by H. Weiner

February 1955

Translation 253

A METHOD OF DETERMINING THE PITCHING AND  
HEAVING CHARACTERISTICS OF SHIPS

(метод определения характеристик  
качки корабля)

by

M. D. Haskind and I. S. Riman

Issued

Bulletin de l'Academie des Sciences de l'URSS  
Classe des Sciences Techniques, 1946

Translated by H. Weiner

February 1955

Translation 253

## A METHOD OF DETERMINING THE PITCHING AND HEAVING CHARACTERISTICS OF SHIPS

M. D. Haskind and I. S. Riman

The usual experimental study of the pitching and heaving motions of a ship model in regular waves consists of determining the amplitude of the oscillations and the phase relation between the oscillations and the wave which, for approximate engineering calculations, suffices.

The theory of oscillatory ship motions in waves, originated by A. N. Krylov<sup>1\*</sup>, makes it possible to calculate the disturbing force acting on a ship in waves by postulating that the forced oscillations of the ship, as well as its presence and forward motion, do not modify the pressure field of the waves. The theory was tested by a comparison of the computed amplitude and phase of the oscillations with experiment.

The authors' task was to develop an experimental method of determining the individual parameters: added mass, damping coefficient and disturbing force, e.g., the quantities required for completely determining the motion of the ship in waves. In carrying out this task, we had the opportunity to delve more deeply into the physical nature of the motion and, at the same time, were able to compare the experimental findings with those of existing theory. The experimental information obtained also provided a basis for checking the validity of the assumptions made in existing theory.

The results of model tests on the motion of ships in regular waves permit us to assume that, in waves encountered at sea, the amplitudes of the pitching and heaving oscillations vary linearly with the height of the waves. This assumption is sufficiently exact to permit us to base the theoretical and experimental study of the pitching and heaving motions of ships in waves on linear theory.

According to a hydrodynamical study of the motion of ships in waves<sup>2</sup>, all the disturbed motion of the water associated with the ship's motion can be resolved into motion of the water caused by the forced oscillation of the ship occurring at a given speed and into motion of the water caused by the presence of the ship as some stationary body in the path of the moving wave.

The motion of the water caused by the forced oscillation of the ship produces forces on the ship, e.g., inertia forces proportional to the acceleration, and damping forces proportional

---

\*References listed on page 8 of this translation.

to the velocity. The constants of proportionality are the so-called added mass and damping coefficient respectively. The motion of the water caused by the movement of the waves past the non-oscillating ship produces disturbing forces on the ship.

We can determine the added mass and damping coefficient associated with the forced oscillation of the ship in waves by carrying out forced oscillations of the ship in still water under the action of known disturbing forces. Having obtained the magnitude of these, and carrying out tests to determine the oscillator motion in given waves, we are able to determine the amplitude and phase of the disturbing forces.

A specially constructed test arrangement at the experimental basin of the N. E. Zhukov Central Aero-Hydrodynamical Institute is used for producing forced oscillations of ship models in still water at desired frequencies. (Figs. 1 and 2) Forced oscillations are transmitted to the model through an elastic connection. A motor, driving a scotch crank and yoke mechanism, produces a linear oscillation which is communicated to the upper end of a spring. To the lower end of the spring is connected a vertical shaft, rigidly attached to the model and free to oscillate in a vertical direction.

We designate by  $m$ , the mass of the ship model, by  $\mu_z$ , the added mass in heaving motion, by  $\lambda_z$ , the damping coefficient, by  $\gamma$ , the weight density of the water, by  $S_0$ , the area of the waterline plane, by  $c$ , the spring constant, by  $r$ , the crank radius, and by  $z$  and  $y$ , respectively, the displacement of the lower and upper ends of the spring.

It is easily seen that the force transmitted through the spring is given by  $F = -c(z-y)$ , where  $y = r \cos kt$  and  $k$  is the frequency of the oscillation. The equation for the forced oscillation can now be written thus:

$$(m + \mu_z) \frac{d^2 z}{dt^2} + \lambda_z \frac{dz}{dt} + (\gamma S_0 + c) z = cr \cos kt \quad (1)$$

We can then assume the forced motion to be in the form:

$$z = Ae^{i(kt - \delta)} \quad (i = \sqrt{-1}) \quad (2)$$

where  $A$  = amplitude of the motion, and

$\delta$  = phase angle between the motion and the disturbing force  
 In this, as well as in all further expressions containing  $\exp ikt$  we need only consider the real part. Substituting expression (2) in (1), we obtain the following:

$$\left[ \gamma S_0 + c - k^2 (m + \mu_z) + ik\lambda_z \right] \cdot A = cre^{i\delta}$$

The amplitude,  $A$ , of the oscillation and the phase angle,  $\delta$  are obtained from the synchronized test record of the displacement of the upper and lower ends of the spring. Equating, in turn, the real and imaginary parts of both sides of the above equation we obtain the following expressions for  $\mu_z$  and  $\lambda_z$ :

$$m + \mu_z = \frac{1}{k^2} \left( \gamma S_0 + c - \frac{cr}{A} \cos \delta \right) \quad (3)$$

$$\lambda_z = \frac{cr}{kA} \sin \delta \quad (4)$$

In the course of the experiments, the crank radius,  $r$ , and the spring constant,  $c$ , were varied over a fairly large range. The variation of the latter was necessary to obtain the relation between the amplitude of the forced oscillation and the amplitude of the disturbing force and to confirm the form (1) of the equation of motion. The variation of the former permitted us to shift resonance to lower or higher frequencies, thus being able to determine more accurately the phase angle  $\delta$ .

For the pure heaving oscillation tests, a symmetrical model was used whose surface equation is expressed by:

$$y = \pm \frac{B}{2} X(x) Z(z) \quad (5)$$

where  $X(x)$  is a function giving the shape at the waterline, and is taken as a fourth degree parabola:

$$X(x) = 1 - \left( \frac{2x}{L} \right)^4 \quad (6)$$

and the function  $Z(z)$  gives the shape of the midship section, and is determined by the equation:

$$Z(z) = \begin{cases} 1 & -\Delta T < z < 0 \\ 1 - \left( -\frac{z}{T-\Delta T} \right)^3 & -(T-\Delta T) < z < -\Delta T \end{cases} \quad (7)$$

in which  $L$ ,  $B$  and  $T$ , the length, beam and draft of the model, respectively, were:  $L = 2000$  mm,  $B = 250$  mm,  $T = 135$  mm, and  $\Delta T$  was 10 mm.

A sketch of the model is shown in Figure 3. Synchronized records of the motions of the upper and lower ends of the spring were taken on a rotating drum. On this drum, specific time intervals were marked off by means of an electromagnetic timer. An example of such a record is given in Figure 4.

In Figures 5 and 6 are presented plots of the experimental results showing the variation with frequency of the relative amplitude,  $\frac{A}{r}$ , and the phase angle,  $\delta$  (for pure heaving oscillations of the symmetrical ship model shown above). As can be seen, the amplitude,  $A$ , is linearly dependent on the radius,  $r$ , but the phase angle,  $\delta$ , does not depend on  $r$ .

Using formulas (3) and (4) for added mass,  $\mu_z$ , and damping coefficient,  $\lambda_z$ , we obtain the variation with frequency of these quantities shown in Figure 7. The value of the added mass,  $\mu_z(k)$  changes radically as the frequency,  $k$ , varies from  $k = 0$  to  $k = \infty$ . The value of  $\mu_z(0)$  can be obtained from the theory of ultra-heavy liquids, and the value of  $\mu_z(\infty)$  from the theory of weightless liquids. The damping coefficient,  $\lambda_z(k)$ , at very low and very high frequencies is extremely small. This means that, in forced oscillations in still water, the action of the water on the ship at very low and very high frequencies reduces to inertia forces, and that the damping of the motion is caused mainly by dissipation of the energy of the ship motion in the formation of waves.

The results of the experimental determination of added mass and damping coefficient are compared with theory<sup>2</sup> in Figures 8 and 9, in which the added mass is taken relative to the mass of the ship model, and the damping coefficient to the quantity  $\frac{\rho}{2} \frac{k^3}{g} S_0^2$ , which represents the theoretical value of the damping coefficient at low frequencies ( $\rho$  = mass density of the liquid, and  $g$  = gravitational acceleration). The comparison of the experimental and theoretical results shows them to be in good agreement.

Now, further tests of ship models in pure heaving motion in given regular waves are carried out. We can write the equation of forced motion in the form:

$$(m + \mu_z) \frac{d^2 z}{dt^2} + \lambda_z \frac{dz}{dt} + \gamma S_0 z = \frac{1}{2} h \gamma S_0 f \cos(kt - \epsilon) = \frac{1}{2} h \gamma S_0 f e^{i(kt - \epsilon)} \quad (8)$$

where  $h$  = height of the wave,  
 $\epsilon$  = phase angle between the disturbing force and the wave,  $\epsilon$   
 $f$  = non-dimensional coefficient of the amplitude of the disturbing force, depending on the relative length of the model,  $\frac{L}{\lambda}$  ( $\lambda$  = wavelength).

Assuming the forced motion, as before, in the form:

$$z = A e^{i(kt - \delta)}$$

and substituting in (8), we get the following:

$$\left[ \gamma S_0 - k^2(m + \mu_z) + ik\lambda_z \right] \cdot A = \frac{1}{2} h \gamma S_0 f e^{i(\delta - \epsilon)} \quad (9)$$

In this case, the unknowns are  $f$ , the non-dimensional coefficient of amplitude of the disturbing force, and  $\epsilon$ , the phase angle. All the remaining quantities are found either by experiment ( $A$  and  $\delta$ ), or have been found previously ( $\mu_z$  and  $\lambda_z$ ).

In Figure 10, a sketch is shown of the record of the heavy oscillations of the model in waves. In Figures 11 and 12 are shown the variation with  $L/\lambda$  of the relative amplitude of the motion,  $2A/h$ , and the phase angle,  $\delta$ , between the ship motion and the waves. The value of  $\delta$  is determined from the synchronous records of the motion of the model and the passage of wave crest through the midship plane of the model. The passage of wave crests through the midship plane is marked off by an electromagnetic timing pen.

Equating real and imaginary parts of both sides of equation (9), as before, we find:

$$f = \frac{2A}{h\gamma S_0} \left\{ [\gamma S_0 - k^2 (m + \mu_z)]^2 + k^2 \lambda_z^2 \right\}^{\frac{1}{2}} \quad (1)$$

$$\text{tg} (\delta - \epsilon) = \frac{k \lambda_z}{\gamma S_0 - k^2 (m + \mu_z)} \quad (2)$$

The quantities  $f(L/\lambda)$  and  $\epsilon(L/\lambda)$  are plotted in Figures 13 and 14. In Figure 13, a comparison is made between the coefficient,  $f$ , and the theoretical values of this coefficient as computed by the theory of A. N. Krylov.

The phase angle,  $\epsilon$ , between the disturbing force and the wave must, according to the theory of A. N. Krylov, be equal to zero. As can be seen, there is some difference between the values of the amplitude and phase angle of the disturbing forces found experimentally and those computed by the theory of Krylov. This difference can be attributed to the change in the pressure field of the waves introduced by the presence of the ship.

To determine the corresponding characteristics for pure pitching oscillations in waves, we can use an analogous method, changing the established scheme only slightly. It is necessary to place a fixed pivot at the center of gravity of the model and to locate a spring at any point along the model centerline with the lower end of the spring attached to a point in the waterline plane and the upper end connected to a vertically oscillating device. The differential equation for the forced pitching motion of a ship model in still water is of the form:

$$(I + \mu_\gamma) \frac{d^2 \psi}{dt^2} + \lambda_\gamma \frac{d\psi}{dt} + (DH + cl^2) \psi = clr \cos kt \quad (1)$$

where  $I$  = mass moment of inertia of the ship model about the center of rotation.

$\mu_\psi$  = added moment of inertia

$\psi$  = angular displacement of model

$\lambda_\psi$  = coefficient of damping

$H$  = metacentric height relative to the center of rotation

$l$  = distance between center of rotation and lower end of spring

[Translator's Note:  $D$  = displacement of the model.]

Determining the motion by experiment in the form:

$$\psi = Be^{i(kt-\theta)} \quad (13)$$

and using (12), we can determine  $\mu_\psi$  and  $\lambda_\psi$  both with and without forward motion. From pure pitching tests in given waves, we can then find the amplitude and phase of the disturbing moments acting on the ship in waves.

In combined heaving and pitching motions, the equations of motion for determining added masses and damping coefficients are of the form:

$$(m + \mu_z) \frac{d^2 z}{dt^2} + \lambda_z \frac{dz}{dt} + \mu_{z\psi} \frac{d^2 \psi}{dt^2} + \lambda_{z\psi} \frac{d\psi}{dt} + \rho S_0 (z + l_1 \psi) + c(z + l_2 \psi) = cr \cos kt \quad (1)$$

$$(I + \mu_\psi) \frac{d^2 \psi}{dt^2} + \lambda_\psi \frac{d\psi}{dt} + \mu_{\psi z} \frac{d^2 z}{dt^2} + \lambda_{\psi z} \frac{dz}{dt} + DH\psi + \rho S_0 (z + l_1 \psi) + cl_2 (z + l_2 \psi) = cl_2 r \cos kt \quad (1)$$

where  $\mu_{z\psi}$ ,  $\lambda_{z\psi}$ ,  $\mu_{\psi z}$  and  $\lambda_{\psi z}$  are the added masses and damping coefficients characteristic of the combined heaving and pitching motion, and  $l_1$  and  $l_2$  are, respectively, the distance to the centroid of the waterline area and to the lower end of the spring from the center of gravity of the ship model.

Determining  $\mu_z$ ,  $\lambda_z$ ,  $\mu_\psi$  and  $\lambda_\psi$  from single degree of freedom tests, and utilizing the experimental record of the combined oscillations:

$$z = Ae^{i(kt-\delta)}, \quad \psi = Be^{i(kt-\theta)} \quad (16)$$



we can determine the added masses and damping coefficients,  $\mu_{zy}$ ,  $\lambda_{zy}$ ,  $\mu_{yz}$  and  $\lambda_{yz}$  from equations (14) and (15). The disturbing force and disturbing moment for the combined motion in given waves remain the same as for single degree of freedom motion in waves. We note that, in the case of symmetrical ship models, the center of gravity being located on the same vertical line as the centroid of the waterline area, the following conditions hold for the added masses and damping coefficients<sup>2</sup>:

$$\mu_{zy} = \mu_{yz} = \lambda_{zy} = \lambda_{yz} = 0, \quad \text{if } u = 0$$

$$\mu_{zy} = -\mu_{yz}, \quad \lambda_{zy} = -\lambda_{yz}, \quad \text{if } u \neq 0$$

where  $u$  is the forward speed.

REFERENCES

1. Krylov, A. N., "The Oscillation of a Ship". (качки корабля) VMA, RKKA, Leningrad, 1938.
2. Haskind, M. D., "The Hydrodynamical Theory of the Oscillation of a Ship in Waves" (гидродинамическая теория качки корабля на волнении ) Prikladnaya Matematika i Mehanika, Vol. 10, No. 1, pp. 33-66, 1946. Translated as Society of Naval Architects and Marine Engineers Technical and Research Bulletin No. 1-12, April 1953.

"Hydrodynamical Methods in Problems of Navigation of Ships in Waves (методы гидродинамики в проблемах мореходности корабля на волнении ) Experimental Basin, Central Aero-Hydrodynamic Institute, Moscow, 1946.

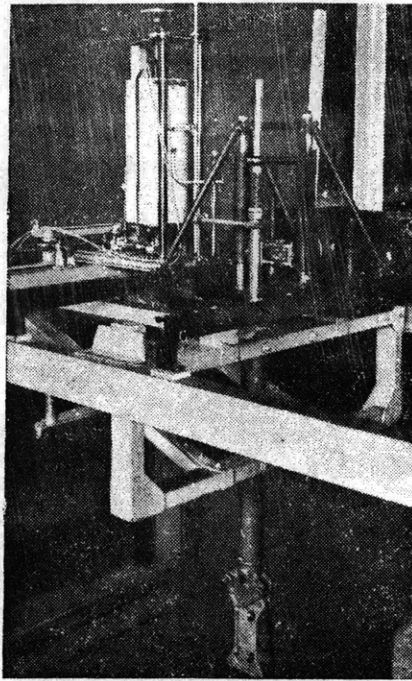

Figure 1

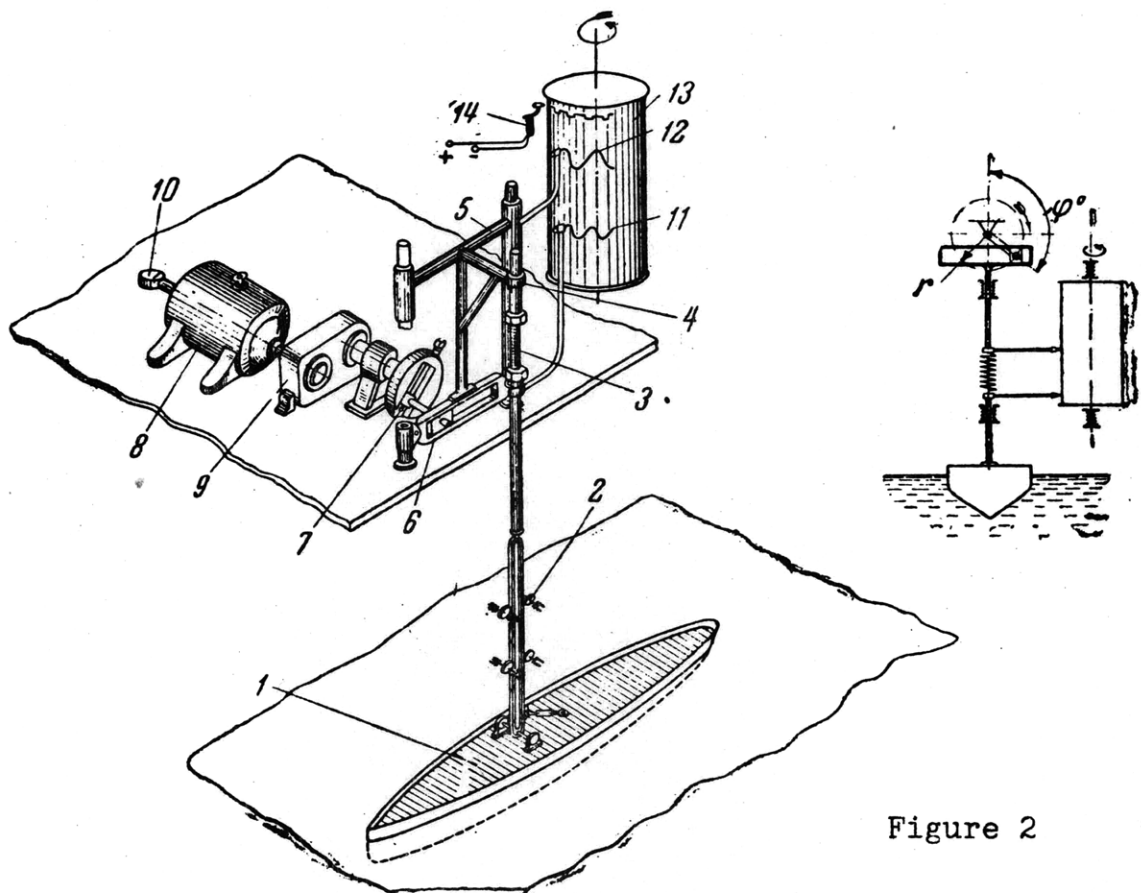

Figure 2

1- Model, 2- Guiding Rollers, 3- Spring, 4- Overhanging Support, 5- Sliding Frame, 6- Slotted Yoke, 7- Crank, 8- Motor, 9- Reductio Gear, 10- Tachometer, 11- Record of Forced Oscillations of the Mod 12- Record of Oscillations of the Disturbing Force, 13- Drum with Paper, 14- Electromagnetic Timer

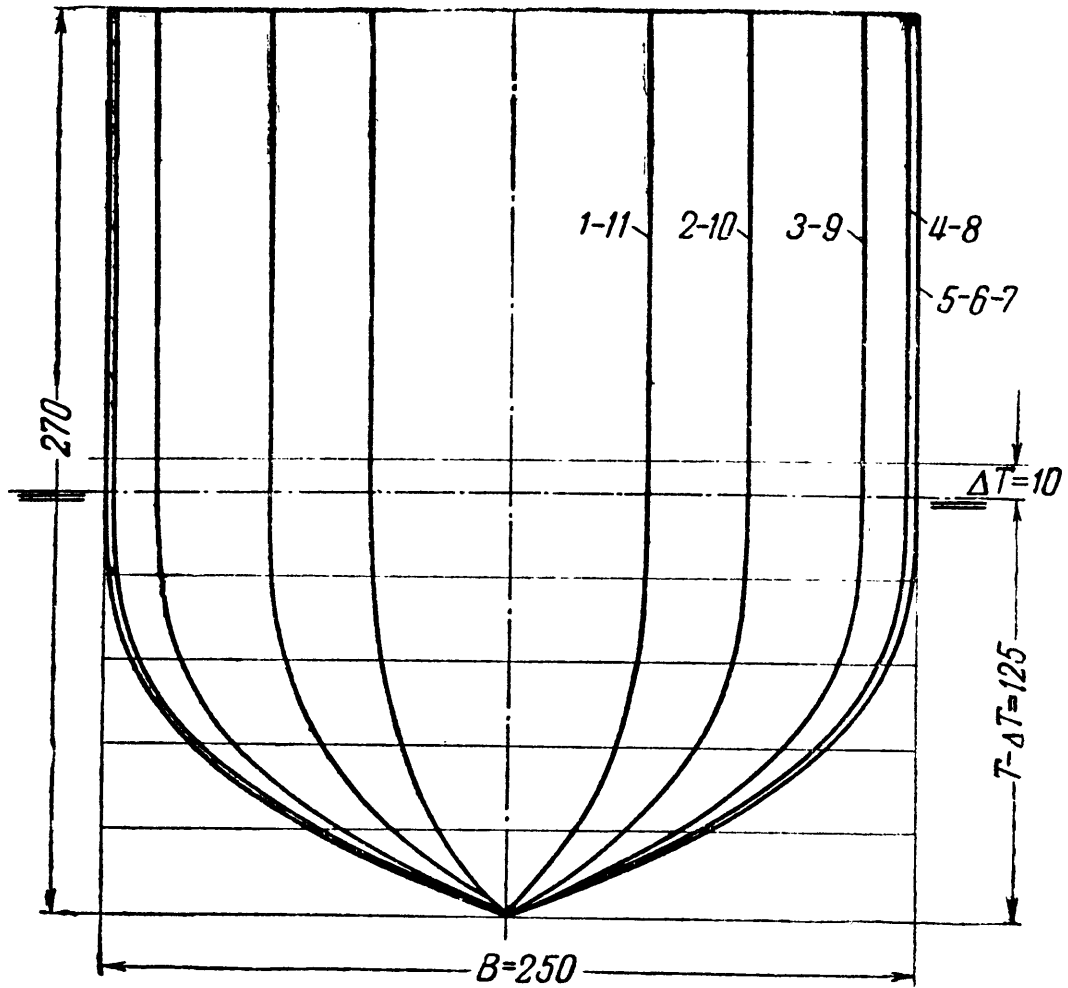

Figure 3- Sketch of the Symmetrical Model

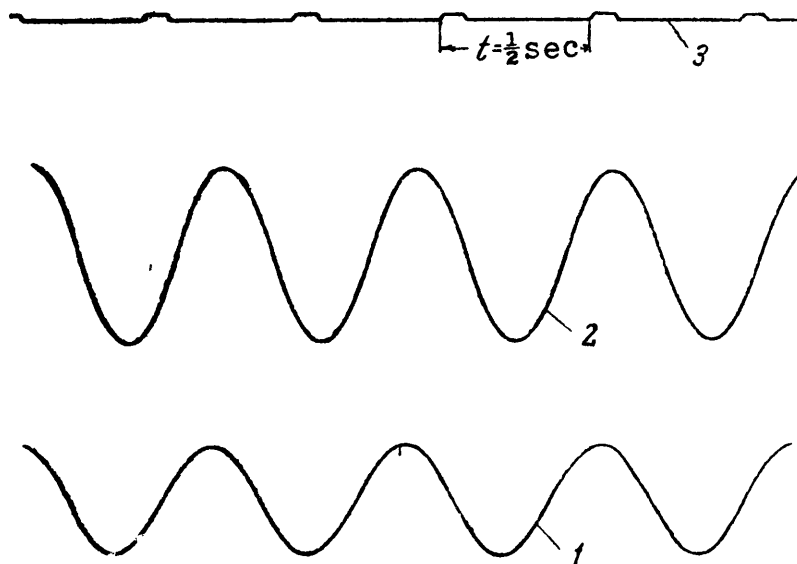

Figure 4

- 1- Record of Oscillations of the Disturbing Force
- 2- Record of Forced Oscillations of the Model
- 3- Time Record

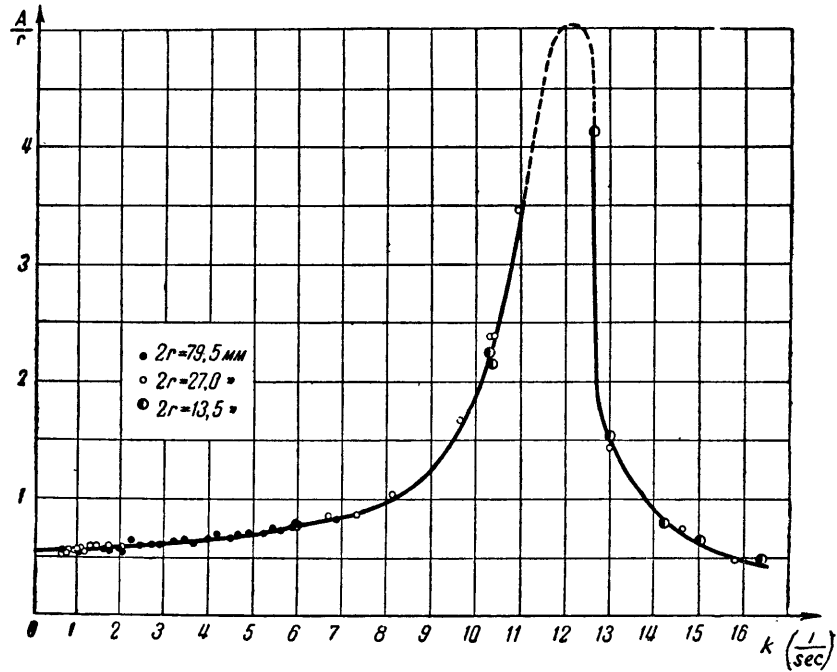

Figure 5

Relative Amplitude of the Forced Heaving Oscillations  
of the Ship Model in Still Water

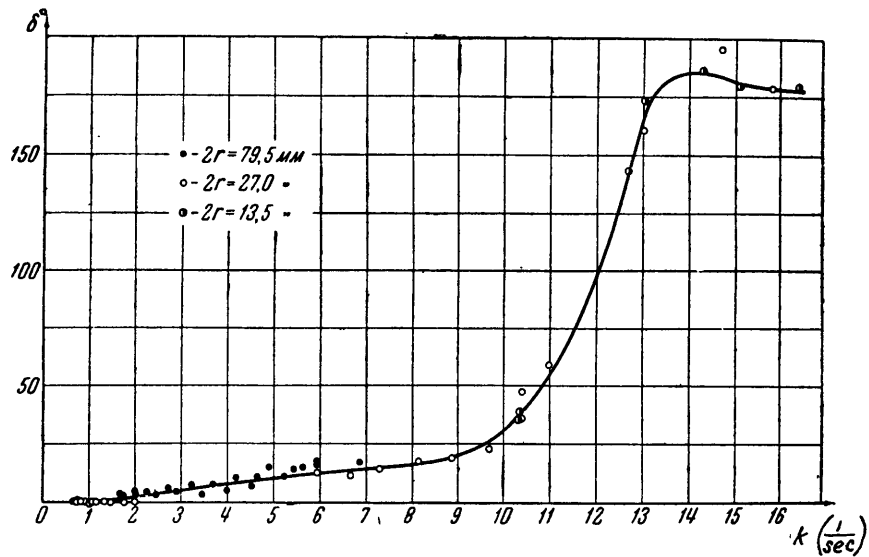
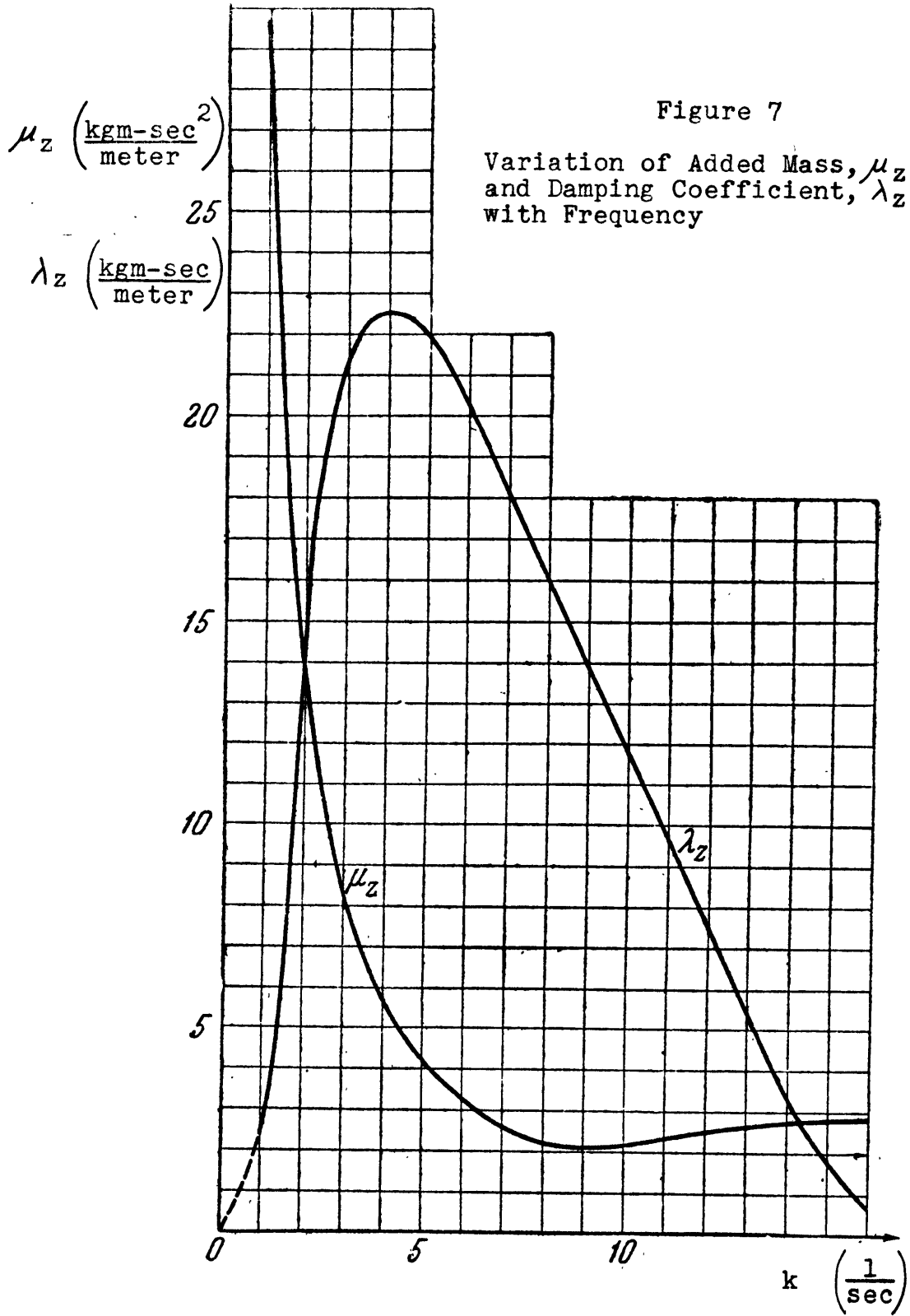
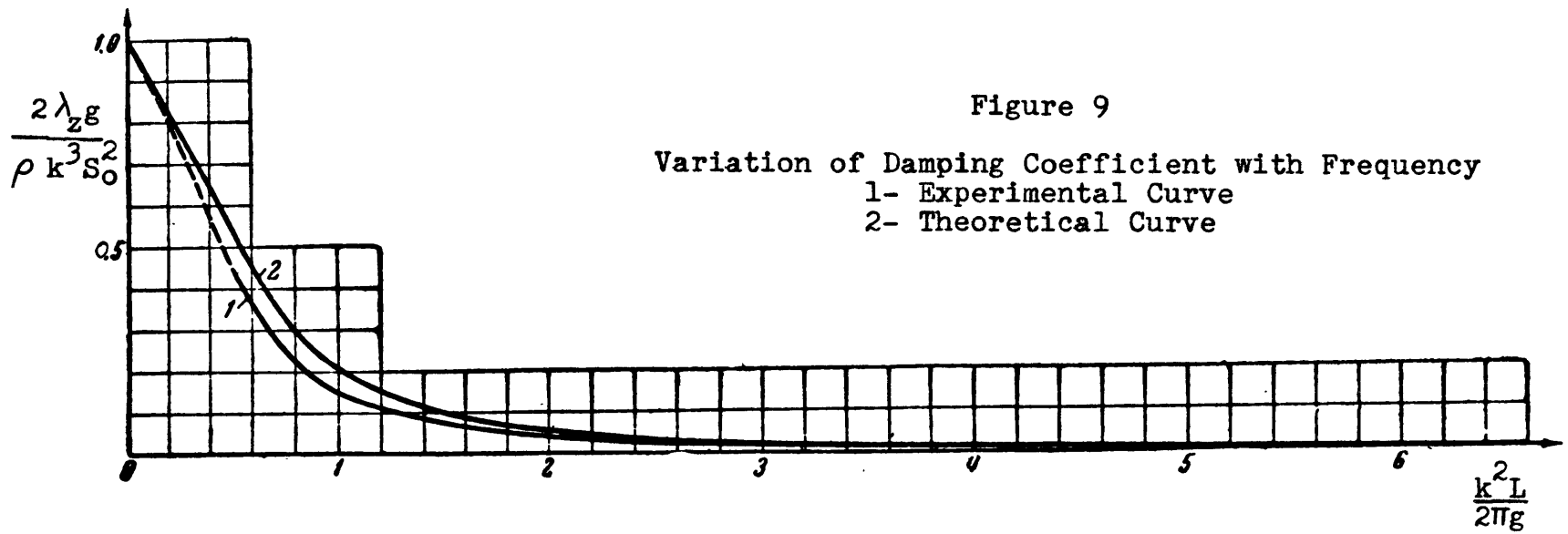
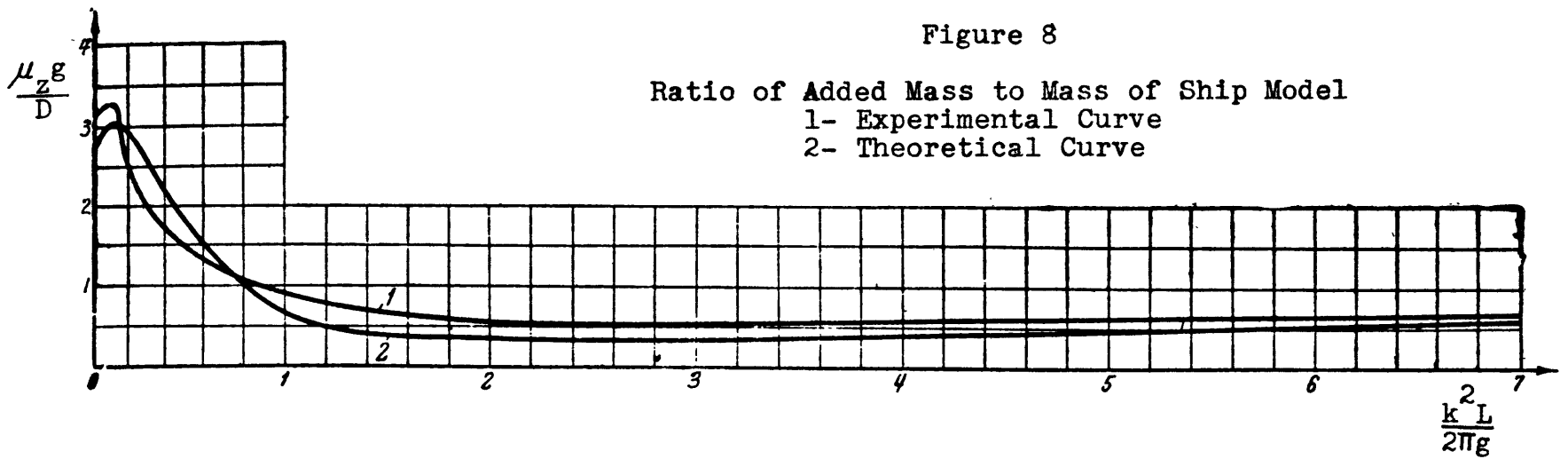

Figure 6

Phase Angle Between the Heaving Motion and the  
Disturbing Force





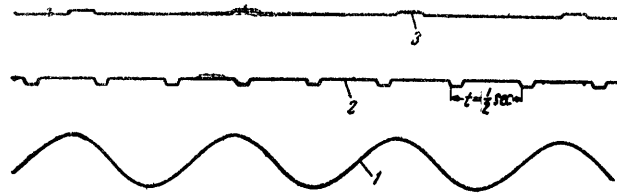

Figure 10

Sample of the Record of Heaving Motion in Waves  
 1- Record of Forced Heaving Motion of Model  
 2- Time Record  
 3- Record of Passage of Wave Crests

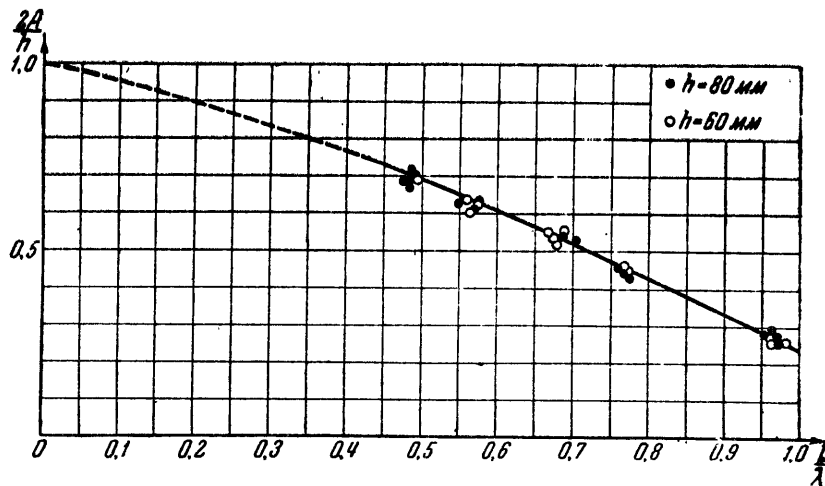

Figure 11

Amplitude of Heaving Motion of Ship Model in Waves

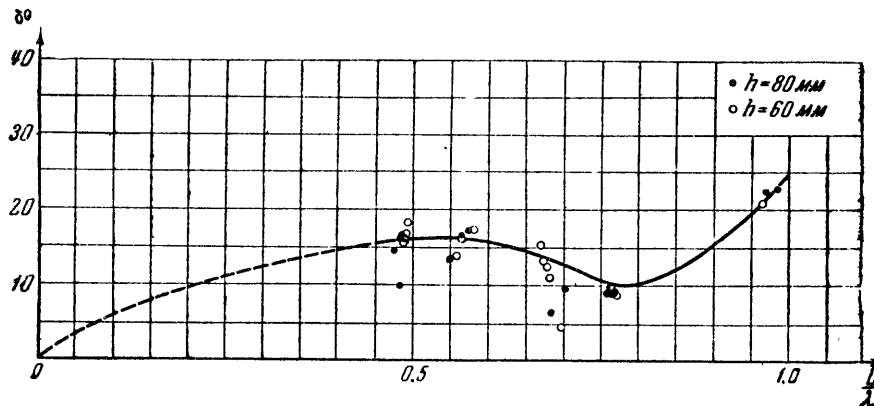

Figure 12

Phase Angle Between the Heaving Motion of the Ship Model and the Wave



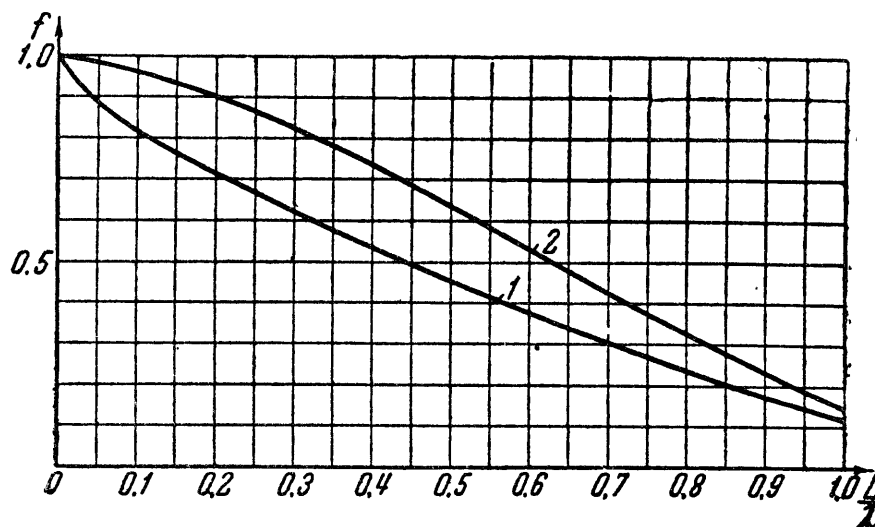

Figure 13

Amplitude of the Disturbing Force Acting in Heaving Motion of the Ship Model in Waves  
 1- Experimental Curve  
 2- Theoretical Curve (From Theory of A.N.Krylov)

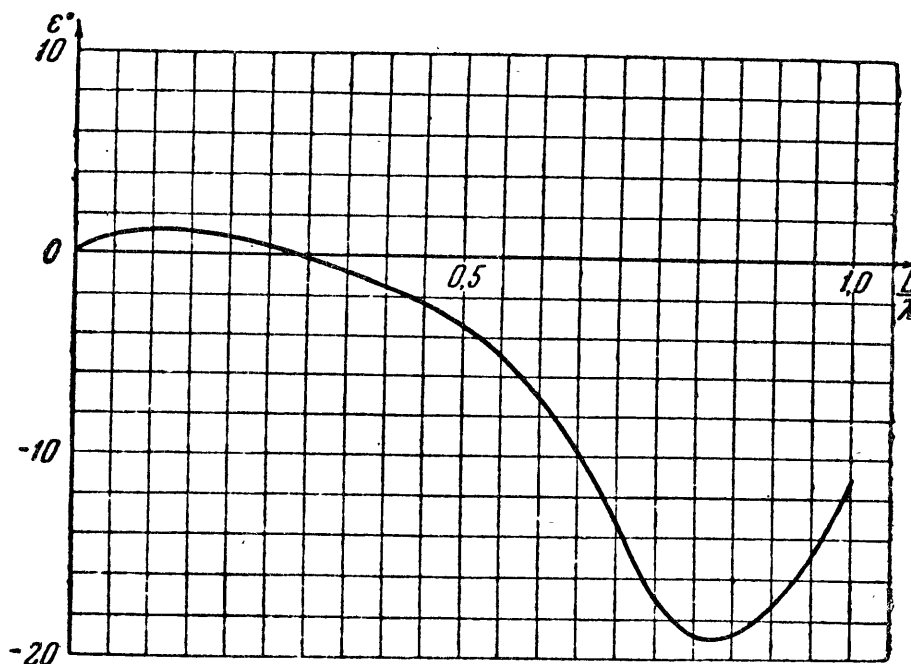

Figure 14

Phase Angle Between the Disturbing Force and the Wave

