

1076

MIT LIBRARIES



3 9080 02754 2403

V393  
.R46

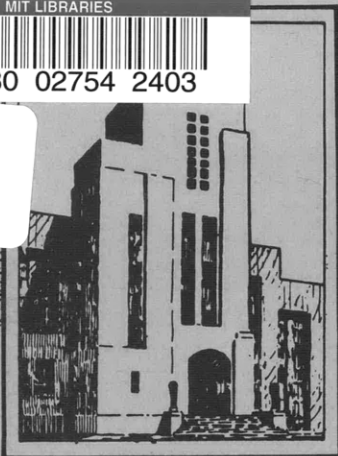

NAVY DEPARTMENT  
**DAVID TAYLOR MODEL BASIN**

HYDROMECHANICS



AERODYNAMICS



STRUCTURAL  
MECHANICS



APPLIED  
MATHEMATICS

THE PLANING CHARACTERISTICS OF AN INVERTED V  
PRISMATIC SURFACE WITH MINUS 10 DEGREES DEAD RISE

by

Peter M. Kimon

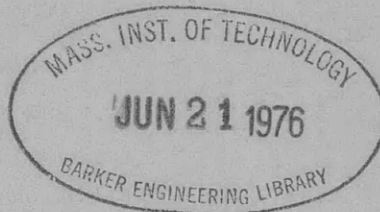

HYDROMECHANICS LABORATORY  
RESEARCH AND DEVELOPMENT REPORT.

March 1957

Report 1076

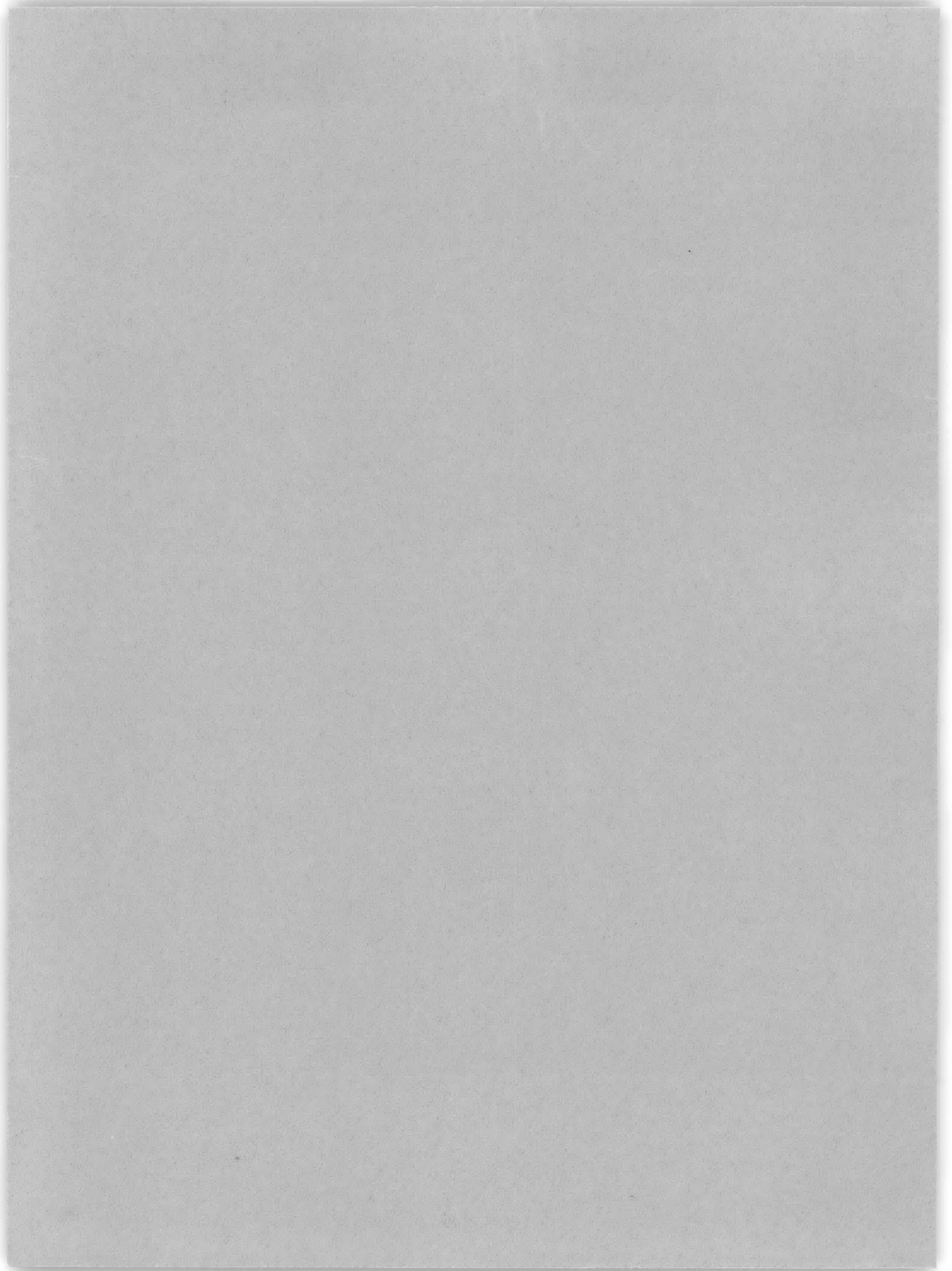

**THE PLANING CHARACTERISTICS OF AN INVERTED V PRISMATIC  
SURFACE WITH MINUS 10 DEGREES DEAD RISE**

**by**

**Peter M. Kimon**

**March 1957**

**Report 1076  
NS715-102**

## TABLE OF CONTENTS

	Page
ABSTRACT .....	1
INTRODUCTION .....	1
DESCRIPTION OF MODEL .....	1
APPARATUS AND PROCEDURES .....	2
General .....	2
Wetted Length and Area .....	2
Draft .....	2
Aerodynamic Tares .....	2
Precision .....	3
RESULTS AND DISCUSSION .....	3
General .....	3
Wetted Length .....	3
Center of Pressure .....	3
Draft .....	4
Buoyancy .....	4
Resistance .....	4
CONCLUSIONS .....	5
REFERENCES .....	6

## NOTATION

$b$	Beam of planing surface, ft
$C_f$	Skin friction drag coefficient, $\frac{F}{\frac{\rho}{2} S_f V_m^2}$
$C_R$	Resistance coefficient, $R/wb^3$
$C_V$	Speed coefficient or Froude number, $V/\sqrt{gb}$
$C_\Delta$	Load coefficient or beam loading, $\Delta/wb^3$
$C_{D_b}$	Drag coefficient based on beam, $\frac{R}{\frac{\rho}{2} V^2 b^2} = \frac{2 C_R}{C_V^2}$
$C_{D_s}$	Drag coefficient based on principal wetted area, $\frac{R}{\frac{\rho}{2} V^2 S} = \frac{C_{D_b}}{\frac{l_m}{b}}$
$C_{L_b}$	Lift coefficient based on beam, $\frac{\Delta}{\frac{\rho}{2} V^2 b^2} = \frac{2 C_\Delta}{C_V^2}$
$C_{L_s}$	Lift coefficient based on principal wetted area, $\frac{\Delta}{\frac{\rho}{2} V^2 S} = \frac{C_{L_b}}{\frac{l_m}{b}}$
$d$	Draft, ft
$F$	Friction, parallel to planing surface, lb
$g$	Acceleration due to gravity, 32.155 ft/sec <sup>2</sup>
$l_c$	Chine wetted length, ft
$l_k$	Keel wetted length, ft
$l_m$	Mean wetted length, $\frac{l_c + l_k}{2}$ , ft
$l_p$	Center-of-pressure location (measured along keel forward of trailing edge), $\frac{M}{\Delta \cos \tau + R \sin \tau}$ , ft
$M$	Trimming moment about trailing edge of model at keel, ft-lb
$R$	Horizontal resistance, lb
$Re$	Reynolds number, $\frac{V_m l_m}{\nu}$
$S$	Principal wetted area (bounded by trailing edge, chines, and heavy spray line) projected on plane parallel to keel, $l_m b$ , sq ft

$S_f$	Actual wetted area aft of stagnation line, sq ft
$V$	Horizontal velocity, ft/sec
$V_m$	Mean velocity over planing surface, ft/sec
$w$	Specific weight of water, lb/cu ft
$\beta$	Angle of dead rise, deg
$\Delta$	Vertical load, lb
$\nu$	Kinematic viscosity, ft <sup>2</sup> /sec
$\rho$	Mass density of water, slugs/cu ft
$\tau$	Trim (angle between keel and horizontal), deg

## ABSTRACT

This report is one of a series on the experimental investigation of the planing characteristics of a series of related prismatic surfaces.

The principal planing characteristics have been obtained for an inverted V prismatic surface having an angle of dead rise of  $-10$  deg. Wetted lengths, resistance, and center-of-pressure location were determined at speed coefficients ranging up to 19.5, beam-loading coefficients from 0.87 to 71.5, and trims up to 30 deg. Keel-wetted-length-beam ratios were extended to approximately 8.0 in all cases where excessive loads or excessive spray conditions were not encountered.

The data indicated that the important planing characteristics are independent of speed and load for a given trim and are dependent primarily upon lift coefficient. The difference between keel wetted length and chine wetted length is constant for a given trim angle. The ratio of center-of-pressure location forward of the trailing edge to the mean wetted length is dependent on trim angle and on wetted length. The drag data indicate that the friction-drag component is a large percentage of the total drag at the low trims but decreases rapidly with increase in trim. At the high trim angles of 24 and 30 deg, the induced drag exceeds the total drag and indicates an apparent negative friction force.

## INTRODUCTION

The National Advisory Committee for Aeronautics and the David Taylor Model Basin have undertaken an experimental investigation of the high-speed planing characteristics of a series of related prismatic surfaces. The principal purpose of this investigation is to extend the available data to high speeds, high trims, and long wetted lengths. The results of tests of surfaces having angles of dead rise of 0, 20, 40, and 50 deg have already been published.<sup>1-6</sup>

The present report gives the results obtained with an inverted prismatic surface having an angle of dead rise of  $-10$  deg. The principal planing characteristics were determined for speed coefficients up to 19.5, beam loadings up to 71.5, wetted lengths up to 8 beams, and trims up to 30 deg. The characteristics determined were wetted length, resistance, center-of-pressure location, and draft for suitable combinations of speed, load, and trim.

## DESCRIPTION OF MODEL

The model is made of brass, has a beam of 4 in., and a dead-rise angle of  $-10$  deg. The length, exclusive of the sheet-metal fairing on the bow, is 36 in. The tolerances and the

---

\*References are listed on page 6.

finish of the model were the same as those described in Reference 1. Figure 1 presents a sketch of the model, and a cross section showing the pertinent dimensions.

## APPARATUS AND PROCEDURES

### GENERAL

The test program was conducted in the high-speed basin on Carriage 3. A brief description of the basin and carriage is given in Reference 7. The apparatus for towing the model and the instrumentation for measuring the lift, drag, and trimming moment are similar to those described in Reference 8. A diagram of the model and towing gear is presented in Figure 2.

### WETTED LENGTH AND AREA

The wetted areas were determined from underwater photographs in the manner described in Reference 6. In addition, visual readings of the chine wetted lengths were recorded with the aid of a scale marked on the side of the model.

Typical underwater photographs of the brass model are shown in Figure 3. It is interesting to note the presence of air bubbles beneath the principal wetted area in the photograph taken at a low trim angle. These were present for most of the test conditions for trim angles of 1 to 12 deg.

The wetted lengths were measured from the trailing edge to the intersection of the keel and chines with the heavy spray line as shown in Figure 3. When this spray line was not disturbed by air bubbles, it was essentially straight from keel to chine throughout the range of the tests, and the mean wetted length was therefore the average of the keel and chine wetted lengths.

### DRAFT

Draft measurements were obtained by the method described in Reference 2, where a vertically oscillating prod was used to measure the changes in the water level. These changes were applied as corrections to visual draft readings. The prod was located slightly forward and to the side of the model. As mentioned in Reference 1, a careful survey of the water surface indicated no appreciable gradient in height in the vicinity of the test area.

### AERODYNAMIC TARES

The aerodynamic forces on the model and towing gear were held to a minimum by the use of a wind screen housing the test section of the towing carriage. Constructed of 1/16-in. aluminum, the wind screen was similar in shape to that described in Reference 2.

The residual windage tares were determined by making a series of runs at various speeds with the model just clearing the surface of the water. The tares for drag, load, and moment were found to be negligible over the speed range.



## PRECISION

The quantities measured are believed to be accurate within the following limits:

Load, lb	$\pm 0.15$
Resistance, lb	$\pm 0.15$
Trimming moment, ft-lb	$\pm 0.50$
Wetted length, in.	$\pm 0.25$
Trim, deg	$\pm 0.10$
Speed, ft/sec	$\pm 0.20$

## RESULTS AND DISCUSSION

### GENERAL

The experimental data obtained for all planing conditions where the deck of the model was dry are presented in Table 1. The corresponding data for the deck-wetted condition have been omitted. For this reason the data for 2-deg trim angle are limited to low wetted length values. However the data for the planing conditions where the sides were wetted (2- and 4-deg trim) have been included in Table 1 and are indicated by an asterisk.

The load, resistance, speed, wetted lengths, and center of pressure are expressed as conventional nondimensional hydrodynamic coefficients based on beam. The lift and drag coefficients are expressed both in terms of the square of the beam and the principal wetted area.

Plots of the data are presented in Figures 4 to 10. When plotted against  $C_{L_b}$ , the experimental data generally fall along a single curve for each trim. These trends are the same as those found for the surfaces having dead-rise angles from 0 to 50 deg.<sup>1-6</sup>

### WETTED LENGTH

The variation of the mean-wetted-length-beam ratio  $l_m/b$  with  $C_{L_b}$  is shown in Figure 4. The relation between the keel-wetted-length-beam ratio  $l_k/b$  and the chine-wetted-length-beam ratio  $l_c/b$  is shown in Figure 5. The difference between the chine wetted length and the keel wetted length is constant for a given trim. By definition, a similar variation necessarily holds for the relation between the mean wetted length and the chine wetted length. This relationship was used to obtain the mean-wetted-length-beam ratio  $l_m/b$  from the visual reading of the chine-wetted-length-beam ratio  $l_c/b$  when an underwater photograph was not available or when the heavy spray line was obscured in a photograph by the presence of air bubbles.

### CENTER OF PRESSURE

The center-of-pressure location  $l_p$  is defined as the distance from the trailing edge to the intersection of the resultant hydrodynamic force vector with the keel of the model. A plot

of center-of-pressure location in beams against  $C_{L_b}$  is presented in Figure 6.

Figure 7 presents plots of  $l_p/b$  against  $l_m/b$  for each of the trim angles. Contrary to the results for the other dead-rise angles,<sup>1-6</sup> there is evidently not a straight line relationship between  $l_p/b$  and  $l_m/b$  for  $-10$  deg dead rise. Instead, for trim angles of 4, 6, 9, and 12 deg, the ratio  $l_p/l_m$  has a definite tendency to decrease with increasing mean wetted length. The  $\lim_{l_m \rightarrow 0} (l_p/l_m)$  is indicated in the plots for these trim angles. For the trim angles of 2, 18, 24, and 30 deg, where the ranges of the values of wetted lengths were comparatively low, a straight line has been drawn through the points in each case, and a constant value of  $l_p/l_m$  is shown. The deviation from a straight-line relationship has been suggested by Shuford<sup>9</sup> for flat plates and by Savitsky<sup>10, 11</sup> for small angles of dead rise.

## DRAFT

A comparison of the measured draft with that computed from the wetted length is presented in Figure 8, where measured draft is plotted against  $(l_c/b) \sin \tau$ . The purpose of these plots, as discussed in References 1 and 2, is to establish whether a pile-up of water occurred at the intersection of the planing surface with the free-water surface. At the higher trims, the measured draft was less than that computed from the wetted length which indicated a piling up of water under the planing surface. At low trims, however, the measured draft was more than that predicted from measurements of the wetted length and suggested a depression of the water level at the leading edge of the planing surface. Evidence of this phenomenon is also presented and discussed in Reference 4.

## BUOYANCY

Following the practice of Reference 4, the light-load low-speed conditions, where the buoyancy exceeded 20 percent of the total load, were considered nonplaning and are not included in this report.

## RESISTANCE

The resistance data are presented in Figure 9 as a plot of drag coefficient  $C_{D_b}$  against lift coefficient  $C_{L_b}$ . The solid lines faired through the data represent the total drag whereas the dashed lines, defined by  $C_{L_b} \tan \tau$ , represent the induced drag. The difference between the solid and dashed lines represents the friction drag. At low trims, the friction drag is a larger portion of the total drag than at the higher trims. At high trims, the induced drag exceeds the total drag and indicates an apparent negative friction force. At these high trims, the volume of forward spray is large and appears to have high forward velocity with respect to the model. The friction drag due to this spray acts in a direction opposite to that of the drag in the principal wetted area and thereby reduces the total drag. Similar effects were observed in Reference 4 and are more fully discussed there.

Skin-friction drag coefficients were calculated directly from the tabular data. The skin-friction drag coefficient was assumed to be

$$C_f = \frac{F}{\frac{\rho}{2} S_f V_m^2}$$

where  $F$  is the friction force parallel to keel,  $R \cos \tau - \Delta \sin \tau$ ;

$S_f$  is the actual wetted area aft of the heavy spray line or  $S/\cos \beta$ ; and

$V_m$  is the mean speed over the surface.

The mean speed was assumed to be that given by Bernoulli's theorem for a surface streamline, with a uniform pressure on the model assumed equal to  $\Delta/S \cos \tau$ . Then  $V_m$  is given by

$$V_m^2 = V^2 \left( 1 - \frac{C_{L_b} \frac{l_m}{b}}{\cos \tau} \right)$$

and  $C_f$  may be shown to be

$$C_f = \cos \beta \cos \tau \frac{C_{D_b} - C_{L_b} \tan \tau}{\frac{l_m}{b} - \frac{C_{L_b}}{\cos \tau}}$$

The Reynolds number for the planing surface was assumed to be  $V_m l_m / \nu$  where  $\nu$  is the kinematic viscosity.

The results of the calculations for trims at which the friction is appreciable are plotted in Figure 10 together with the Schoenherr line<sup>12</sup> for fully turbulent boundary layer and the Blasius line for laminar flow on flat plates. Most of the coefficients for the lighter loads and lower Reynolds numbers were erratic because of the marginal accuracy. All conditions, therefore, where the precision of measurement changed the coefficient by more than 20 percent were omitted from this plot. The grouping of the data along the Schoenherr turbulent-flow line indicates that at low trims and high Reynolds numbers, the friction drag can be calculated with reasonable accuracy by use of the Schoenherr equation.

## CONCLUSIONS

The results obtained from an experimental investigation of an inverted  $V$  planing surface having an angle of dead rise of  $-10$  deg indicate that during steady-state planing, the important planing characteristics are independent of speed and load for a given trim and are dependent only on lift coefficient. The difference between chine wetted length and keel wetted length is constant for a given trim angle. The ratio of center-of-pressure location forward of the trailing edge to the mean wetted length appears to be dependent on both the trim angle and on the wetted length. The drag data indicate that the friction-drag component is a large percentage of the

total drag at low trims but that it decreases rapidly with increase in trim to a small negative component at the higher trims. For practical purposes, the total hydrodynamic drag for trim angles above 12 deg can be considered equal to the induced drag of the surface.

## REFERENCES

1. Kapryan, W.J. and Weinstein, I., "The Planing Characteristics of a Surface Having a Basic Angle of Dead Rise of 20° and Horizontal Chine Flare," National Advisory Committee for Aeronautics TN 2804 (1952).
2. Blanchard, U.J., "The Planing Characteristics of a Surface Having a Basic Angle of Dead Rise of 40° and Horizontal Chine Flare," National Advisory Committee for Aeronautics TN 2842 (1952).
3. Kapryan, W.J. and Boyd, G.M., Jr., "The Effect of Vertical Chine Strips on the Planing Characteristics of V-Shaped Prismatic Surfaces Having Angles of Dead Rise of 20° and 40°," National Advisory Committee for Aeronautics TN 3052 (1953).
4. Weinstein, I. and Kapryan, W.J., "The High Speed Planing Characteristics of a Rectangular Flat Plate Over a Wide Range of Trim and Wetted Length," National Advisory Committee for Aeronautics TN 2981 (1953).
5. Chambliss, D.B. and Boyd, G.M., Jr., "The Planing Characteristics of Two V-Shaped Prismatic Surfaces Having Angles of Dead Rise of 20° and 40°," National Advisory Committee for Aeronautics TN 2876 (1953).
6. Springston, G.B., Jr., and Sayre, C.L., Jr., "The Planing Characteristics of a V-Shaped Prismatic Surface with 50 Degrees Dead Rise," David Taylor Model Basin Report 920 (1955).
7. Saunders, H.E., Captain, USN, and Hodtwalker, M., "A Manual for Visitors to the David W. Taylor Model Basin," David Taylor Model Basin Report 569 (1947).
8. Truscott, S., "The Enlarged NACA Tank, and Some of Its Work," National Advisory Committee for Aeronautics TM 918 (1939).
9. Shuford, C.L., Jr., "A Review of Planing Theory and Experiment with Theoretical Study of Pure-Planing Lift of Rectangular Flat Plates," National Advisory Committee for Aeronautics TN 3233 (1954).

10. Savitsky, D., "Wetted Length and Center of Pressure of Vee-Step Planing Surfaces," S.M.F. Fund Paper No. FF-6, Institute of the Aeronautical Sciences (Report No. 378, Project No. NR 062-012, Office of Naval Research, Experimental Towing Tank, Stevens Institute of Technology, Sep 1951).

11. Savitsky, D. and Neidinger, J.W., "Wetted Area and Center of Pressure of Planing Surfaces at Very Low Speed Coefficients," S.M.F. Fund Paper No. FF-11, Institute of the Aeronautical Sciences (Report No. 493, Project No. NR 062-012, Office of Naval Research, Experimental Towing Tank, Stevens Institute of Technology, July 1954).

12. Davidson, K.S.M., "Resistance and Powering. Detailed Considerations – Skin Friction," Vol. II of "Principles of Naval Architecture," Chapter II, Part 2, Section 7, Henry E. Rossell and Lawrence B. Chapman, Editors, Society of Naval Architecture and Marine Engineering (1939), pp. 76-83.

TABLE 1

Experimental Data Obtained for Minus 10-Degree Dead-Rise Planing Surface

Average kinematic viscosity =  $1.062 \times 10^{-5}$  ft<sup>2</sup>/sec; average specific weight of basin water = 62.26 lb/ft<sup>3</sup>.

$\tau$ deg	$C_{\Delta}$	$C_V$	$C_R$	$\frac{l_c}{b}$	$\frac{l_m}{b}$	$\frac{l_k}{b}$	$\frac{l_p}{b}$	$\frac{d}{b}$	$C_{L_b}$	$C_{D_b}$	$C_{L_s}$	$C_{D_s}$
2*	0.87	9.33	0.22	1.80	1.09	-	0.84	-	0.0199	0.0050	0.0182	0.0046
2*	2.17	9.83	0.83	4.05	3.34	-	2.74	-	.0449	.0170	.0134	.0051
2*	2.17	11.90	0.52	2.30	1.59	0.88	1.10	-	.0306	.0074	.0193	.0046
2*	2.17	14.74	0.50	1.63	0.92	-	0.77	-	.0199	.0046	.0217	.0050
2*	2.17	17.58	0.60	1.60	0.88	0.15	0.36	-	.0140	.0039	.0160	.0045
2*	4.34	13.91	1.80	5.25	4.53	3.81	3.44	-	.0448	.0186	.0099	.0041
2*	4.34	15.99	1.08	2.63	1.90	1.18	1.43	-	.0339	.0085	.0178	.0045
4*	0.87	9.33	0.10	0.73	0.47	-	0.31	-	.0199	.0025	.0422	.0053
4*	2.17	7.39	0.32	1.90	1.65	-	1.28	-	.0795	.0119	.0482	.0072
4*	2.17	9.84	0.26	0.88	0.62	-	0.44	-	.0448	.0054	.0719	.0086
4*	2.17	14.73	0.29	0.63	0.37	-	-	-	.0200	.0026	.0536	.0070
4	4.34	13.91	0.54	0.83	0.57	-	0.46	0.070	.0448	.0056	.0783	.0098
4	6.50	12.77	0.92	1.58	1.32	-	1.09	0.135	.0797	.0112	.0603	.0084
4	6.50	17.02	0.80	0.88	0.57	0.26	0.35	-	.0449	.0055	.0788	.0097
4	10.84	11.35	2.35	7.94	7.66	7.39	5.53	-	.1683	.0364	.0220	.0047
4	10.84	11.89	2.26	6.88	6.65	6.43	4.89	-	.1535	.0319	.0231	.0048
4	10.84	12.38	2.14	5.15	4.90	-	3.87	0.408	.1414	.0280	.0289	.0057
4	10.84	13.21	1.98	4.10	3.85	-	3.11	0.320	.1243	.0226	.0323	.0059
4	10.84	14.47	1.78	2.88	2.62	-	2.06	0.230	.1035	.0170	.0395	.0065
4	10.84	14.96	1.73	3.00	2.75	-	2.13	-	.0969	.0155	.0353	.0056
4*	10.84	16.50	1.52	1.64	1.41	1.19	1.15	-	.0797	.0112	.0564	.0079
4	19.51	16.54	3.92	5.83	5.57	-	-	-	.1427	.0287	.0256	.0051
4	19.51	17.67	3.58	4.74	4.48	4.21	3.45	-	.1249	.0229	.0279	.0051
6	2.17	7.39	0.29	0.73	0.59	-	0.66	-	.0794	.0103	.1342	.0174
6	2.17	9.80	0.29	0.50	0.35	-	0.22	-	.0451	.0059	.1290	.0168
6	2.17	14.75	0.31	0.40	0.27	-	0.11	-	.0199	.0028	.0748	.0105
6	6.50	10.22	0.99	1.53	1.39	1.25	1.18	-	.1244	.0191	.0897	.0138
6	6.50	12.77	0.89	0.75	0.62	-	0.53	0.095	.0797	.0109	.1294	.0177
6	6.50	16.47	0.96	0.50	0.37	-	-	-	.0480	.0070	.1310	.0192
6	10.84	9.40	2.00	5.93	5.79	-	4.14	-	.2454	.0452	.0424	.0078
6	10.84	11.00	1.80	3.38	3.24	-	2.54	-	.1792	.0298	.0553	.0092
6	10.84	13.19	1.56	1.48	1.34	-	1.09	0.183	.1247	.0180	.0930	.0134
6	10.84	16.49	1.43	0.75	0.63	0.51	0.52	-	.0798	.0105	.1264	.0167
6	19.51	11.07	3.71	8.58	8.44	-	5.79	-	.3185	.0605	.0377	.0072
6	19.51	11.87	3.62	7.26	7.14	7.01	5.01	-	.2772	.0514	.0388	.0072
6	19.51	12.62	3.51	5.80	5.67	-	4.14	0.620	.2451	.0441	.0433	.0078
6	19.51	13.68	3.29	4.63	4.50	4.37	3.31	-	.2085	.0351	.0463	.0078
6	19.51	14.74	3.16	3.35	3.22	-	-	0.358	.1795	.0291	.0558	.0091
6	19.51	17.67	-	1.58	1.44	-	-	-	.1250	-	.0867	-
6	19.51	17.69	2.82	1.60	1.47	-	1.16	-	0.1247	0.0180	0.0850	0.0123

\*Conditions for which the sides of the model were wetted.

TABLE 1 (continued)

$\tau$ deg	$C_{\Delta}$	$C_V$	$C_R$	$\frac{l_c}{b}$	$\frac{l_m}{b}$	$\frac{l_k}{b}$	$\frac{l_p}{b}$	$\frac{d}{b}$	$C_{L_b}$	$C_{D_b}$	$C_{L_s}$	$C_{D_s}$
6	28.19	17.76	4.55	3.45	3.32	-	2.52	-	0.1788	0.0289	0.0539	0.0087
6	36.86	15.20	7.02	8.75	8.62	-	6.03	0.945	.3192	.0608	.0370	.0071
6	36.86	17.40	6.51	6.04	5.91	5.79	4.30	-	.2436	.0430	.0412	.0073
6	54.21	18.37	10.15	8.86	8.70	8.54	5.98	-	.3214	.0602	.0369	.0069
9	2.17	7.38	0.37	0.45	0.38	-	-	-	.0797	.0135	.2104	.0358
9	2.17	14.73	0.37	0.25	0.18	-	-	-	.0200	.0034	.1118	.0190
9	6.50	10.21	1.18	0.70	0.63	-	0.57	-	.1247	.0224	.1983	.0357
9	6.50	12.75	-	0.48	0.40	-	-	0.078	.0801	-	.1983	-
9	6.50	17.01	1.15	-	-	-	0.35	-	.0449	.0079	-	-
9	6.50	17.02	1.34	0.38	0.30	-	-	-	.0449	.0093	.1478	.0305
9	10.84	9.40	2.01	2.30	2.23	2.15	1.74	-	.2451	.0456	.1102	.0205
9	10.84	10.97	1.95	1.30	1.23	-	0.87	-	.1802	.0324	.1467	.0264
9	10.84	13.17	-	0.68	0.60	-	-	0.118	.1250	-	.2070	-
9	10.84	16.47	1.80	0.45	0.38	-	0.27	-	.0800	.0133	.2105	.0350
9	15.18	9.82	2.93	3.65	3.58	3.50	2.60	-	.3146	.0607	.0880	.0170
9	19.51	9.81	3.91	5.55	5.48	5.40	3.82	-	.4054	.0811	.0740	.0148
9	19.51	11.06	3.77	3.80	3.75	3.70	2.67	-	.3190	.0617	.0851	.0164
9	19.51	12.62	-	2.20	2.13	-	-	0.338	.2449	-	.1150	-
9	19.51	14.72	-	1.24	1.17	-	-	0.195	.1800	-	.1544	-
9	19.51	17.68	3.28	0.73	0.65	-	0.41	-	.1248	.0209	.1909	.0320
9	28.18	17.65	4.90	1.30	1.23	1.16	0.90	-	.1809	.0314	.1475	.0256
9	36.86	12.12	7.61	7.51	7.44	7.36	5.10	-	.5016	.1036	.0674	.0139
9	36.86	12.14	-	7.56	7.49	-	-	-	.5003	-	.0668	-
9	36.86	13.49	-	5.34	5.27	-	-	0.835	.4051	-	.0769	-
9	36.86	15.18	-	3.63	3.55	-	-	0.568	.3200	-	.0901	-
9	36.86	17.34	6.69	2.28	2.20	-	1.69	-	.2451	.0445	.0112	.0202
9	54.20	14.72	-	7.18	7.10	-	-	1.143	.5001	-	.0704	-
9	54.20	15.48	11.00	6.54	6.49	6.44	4.52	-	.4526	.0918	.0698	.0141
9	54.20	16.33	10.82	5.56	5.49	5.41	3.89	-	.4064	.0811	.0741	.0148
9	54.20	17.33	10.54	4.65	4.58	-	3.28	-	.3608	.0701	.0788	.0153
9	54.20	18.42	10.26	3.81	3.74	3.66	2.73	-	.3196	.0605	.0855	.0162
9	71.55	16.87	14.68	7.53	7.45	-	5.08	-	.5028	.1032	.0675	.0138
9	71.55	16.93	14.75	7.51	7.44	7.36	5.13	-	.4992	.1029	.0671	.0138
12	2.17	7.27	0.50	0.38	0.34	-	-	-	.0820	.0188	.2437	.0561
12	2.17	7.39	0.50	0.38	0.34	-	-	-	.0793	.0182	.2360	.0543
12	2.17	14.74	-	0.13	0.09	-	-	-	.0199	-	.2313	-
12	4.34	13.87	1.05	0.25	0.21	-	-	-	.0451	.0108	.2135	.0512
12	6.50	10.21	1.44	0.54	0.50	-	0.41	-	.1247	.0274	.2500	.0274
12	8.67	19.63	1.82	0.25	0.21	-	0.19	-	.0450	.0095	.2131	.0447
12	10.84	10.99	2.48	-	-	-	0.53	-	.1796	.0409	-	-
12	10.84	11.02	2.41	0.80	0.76	-	0.51	-	.1786	.0396	.2361	.0524
12	10.84	16.50	2.39	0.40	0.36	-	-	-	.0797	.0175	.2205	.0485
12	19.51	11.07	4.45	1.93	1.89	-	1.38	-	.3184	.0725	.1681	.0383
12	19.51	12.62	4.33	1.25	1.21	1.17	0.89	-	0.2451	0.0545	0.2030	0.0451

TABLE 1 (continued)

$\tau$ deg	$C_{\Delta}$	$C_V$	$C_R$	$\frac{l_c}{b}$	$\frac{l_m}{b}$	$\frac{l_k}{b}$	$\frac{l_p}{b}$	$\frac{d}{b}$	$C_{L_b}$	$C_{D_b}$	$C_{L_s}$	$C_{D_s}$
12	19.51	12.62	-	1.20	1.16	-	-	0.240	0.2449	-	0.2109	-
12	19.51	12.62	-	1.20	1.16	-	-	0.243	.2449	-	.2109	-
12	19.51	14.72	-	0.75	0.71	-	-	0.138	.1800	-	.2531	-
12	19.51	17.67	4.18	0.63	0.59	-	0.24	-	.1249	0.0268	.2131	0.457
12	28.18	12.62	-	2.30	2.26	-	-	0.438	.3537	-	.1564	-
12	36.86	12.12	8.70	4.16	4.12	-	2.91	-	.5016	.1183	.1216	.0287
12	36.86	12.16	8.73	4.13	4.09	4.05	2.88	-	.4982	.1181	.1218	.0289
12	36.86	13.47	8.44	2.95	2.91	2.88	2.10	-	.4060	.0929	.1394	.0319
12	36.86	13.48	8.54	2.93	2.90	2.86	2.09	-	.4054	.0940	.1399	.0324
12	36.86	13.49	-	2.90	2.86	-	-	0.555	.4051	-	.1416	-
12	36.86	15.18	-	1.93	1.89	-	-	0.368	.3200	-	.1697	-
12	36.86	17.33	8.06	1.25	1.21	-	1.10	-	.2454	.0537	.2026	.0043
12	54.20	14.72	-	4.19	4.15	-	-	0.833	.5001	-	.1205	-
12	54.20	15.45	12.43	3.64	3.60	3.56	2.56	-	.4544	.1042	.1262	.0289
12	54.20	16.38	12.31	2.98	2.94	2.91	2.11	-	.4038	.0917	.1373	.0312
12	54.20	17.33	12.18	2.46	2.43	2.39	1.74	-	.3608	.0811	.1488	.0334
12	54.20	18.38	11.97	2.00	1.96	1.92	1.41	-	.3210	.0709	.1639	.0362
12	71.55	16.89	16.63	4.29	4.25	4.21	-	-	.5016	.1166	.1181	.0274
18	0.87	9.34	0.44	0.13	0.12	-	0.62	-	.0199	.0099	.1728	.0864
18	2.17	5.90	0.72	0.45	0.44	0.43	-	-	.1245	.0411	.2846	.0939
18	2.17	7.38	0.72	0.28	0.27	-	-	-	.0797	.0264	.2952	.0978
18	2.17	14.76	0.60	-	-	-	-	-	.0199	.0056	.1421	.0398
18	6.50	10.20	2.13	0.45	0.44	-	-	-	.1249	.0408	.2839	.0928
18	6.50	10.22	2.13	0.40	0.39	-	-	-	.1244	.0406	.3191	.1042
18	6.50	17.01	2.21	-	-	-	-	-	.0450	.0153	.1697	.0577
18	10.84	9.41	3.51	0.70	0.69	-	0.48	-	.2449	.0793	.3549	.1149
18	10.84	11.03	3.47	0.51	0.50	-	0.38	-	.1782	.0570	.3547	.1135
18	19.51	8.84	6.30	1.91	1.91	1.90	1.34	-	.4997	.1616	.2622	.0848
18	19.51	9.83	6.22	1.37	1.35	1.33	0.96	-	.4037	.1287	.2987	.0953
18	19.51	10.47	6.15	1.11	1.10	1.09	0.81	-	.3558	.1123	.3228	.1019
18	19.51	11.05	6.08	0.91	0.90	0.89	0.64	-	.3196	.0994	.3541	.1102
18	19.51	12.65	6.15	0.65	0.64	-	-	-	.2439	.0770	.3811	.1203
18	19.51	14.72	6.14	0.46	0.45	-	0.29	0.108	.1800	.0566	.3979	.1251
18	19.51	17.64	-	0.38	0.37	-	-	-	.1254	-	.3435	-
18	28.18	17.64	8.72	0.45	0.44	-	0.22	-	.1811	.0560	.4093	.1266
18	30.36	12.14	-	1.36	1.35	-	-	-	.4120	-	.3047	-
18	36.86	12.17	11.75	1.81	1.80	-	1.28	-	.4978	.1587	.2762	.0880
18	36.86	12.91	11.66	1.51	1.50	-	1.06	0.285	.4425	.1400	.2945	.0932
18	36.86	12.92	11.44	1.58	1.58	1.57	1.09	0.420	.4418	.1372	.2803	.0870
18	36.86	13.55	11.56	1.30	1.29	-	0.91	0.333	.4014	.1259	.3112	.0976
18	36.86	15.18	11.40	0.91	0.90	-	0.64	-	-	.0990	.3546	.1097
18	36.86	17.34	11.31	0.60	0.59	-	0.44	0.278	.2451	.0752	.4154	.1275
18	54.20	14.74	16.73	1.86	1.86	1.85	1.28	0.175	.4987	.1540	.2687	.0830
18	54.20	16.37	16.45	1.34	1.33	1.33	0.92	-	0.4043	0.1228	0.3037	0.0922



TABLE 1 (concluded)

$\tau$ deg	$C_{\Delta}$	$C_V$	$C_R$	$\frac{l_c}{b}$	$\frac{l_m}{b}$	$\frac{l_k}{b}$	$\frac{l_p}{b}$	$\frac{d}{b}$	$C_{L_b}$	$C_{D_b}$	$C_{L_s}$	$C_{D_s}$
18	54.20	17.34	-	1.08	1.07	1.06	-	-	0.3604	-	0.3372	-
18	54.20	18.43	16.26	0.95	0.94	0.93	0.61	-	.3193	0.0958	.3397	0.1019
24	0.87	4.67	0.42	0.23	0.22	-	0.21	-	.0796	.0378	.3617	.1718
24	2.17	4.20	0.98	0.55	0.55	-	0.31	-	.2453	.1104	.4501	.2025
24	2.17	4.92	0.99	0.43	0.42	-	0.22	-	.1790	.0824	.4263	.1961
24	2.17	5.89	-	0.33	0.32	-	-	-	.1249	-	.3904	-
24	2.17	7.40	0.96	0.23	0.22	-	0.13	-	.0791	.0348	.3597	.1582
24	10.84	11.00	4.56	0.35	0.35	-	0.27	-	.1792	.0753	.5195	.2182
24	19.51	8.87	8.45	1.25	1.24	1.24	0.84	-	.4963	.2150	.4002	.1734
24	19.51	9.82	8.32	0.96	0.95	0.95	0.62	-	.4045	.1726	.4252	.1814
24	19.51	10.42	8.29	0.79	0.79	0.78	0.51	-	.3594	.1525	.4578	.1943
24	19.51	11.06	8.16	0.65	0.65	-	0.43	0.135	.3190	.1333	.4946	.2067
24	19.51	11.08	8.24	0.70	0.70	0.69	0.45	-	.3178	.1342	.4573	.1931
24	19.51	12.61	8.09	0.46	0.45	-	0.34	0.090	.2455	.1018	.5456	.2261
24	19.51	12.83	8.16	0.46	0.46	0.45	0.27	-	.2369	.0990	.5178	.2163
24	19.51	14.75	8.09	0.33	0.32	-	0.07	-	.1793	.0743	.5602	.2322
24	19.51	17.66	8.03	0.33	0.32	-	0.28	-	.1251	.0514	.3909	.1607
24	36.86	12.12	15.62	1.24	1.23	-	0.83	0.355	.5016	.2125	.4070	.1724
24	36.86	12.93	15.61	1.04	1.03	1.03	0.71	-	.4411	.1868	.4277	.1811
24	36.86	13.51	15.40	0.90	0.90	-	0.60	0.263	.4042	.1688	.4516	.1886
24	36.86	14.45	15.37	0.75	0.74	0.73	0.51	-	.3531	.1472	.4771	.1990
24	36.86	14.45	15.31	0.75	0.75	-	-	0.218	.3528	.1465	.4736	.1967
24	36.86	15.15	15.39	0.70	0.70	0.69	0.44	-	.3213	.1342	.4615	.1928
24	36.86	15.18	15.27	0.65	0.65	-	0.40	0.200	.3201	.1325	.4962	.2055
24	54.20	14.70	-	1.26	1.26	1.25	-	-	.5015	-	.3996	-
24	54.20	14.71	22.55	1.24	1.24	1.24	0.83	-	.5008	.2083	.4043	.1682
24	54.20	16.38	-	0.97	0.96	0.96	-	-	.4038	-	.4190	-
24	54.20	18.40	22.11	0.70	0.69	0.69	0.41	-	.3201	.1306	.4631	.1890
30	2.17	4.20	1.27	0.50	0.50	0.49	0.39	-	.2453	.1447	.4968	.2931
30	2.17	4.89	1.21	0.33	0.33	0.33	-	-	.1813	.1015	.5578	.3124
30	2.17	5.89	1.18	0.23	0.23	-	-	-	.1249	.0675	.5679	.3067
30	10.84	11.03	5.87	0.30	0.30	-	0.15	-	.1782	.0966	.6042	.3275
30	19.52	8.83	-	1.04	1.03	1.03	-	-	.5004	-	.4852	-
30	19.51	9.80	-	0.75	0.75	-	0.50	-	.4062	-	.5452	-
30	19.51	11.06	10.49	0.58	0.57	-	0.39	-	.3193	.1717	.5602	.3013
30	19.51	12.63	10.28	0.40	0.40	-	0.24	-	.2445	0.1288	.6190	0.3260
30	36.86	12.15	-	1.04	1.03	1.03	-	-	0.4991	-	0.4840	-

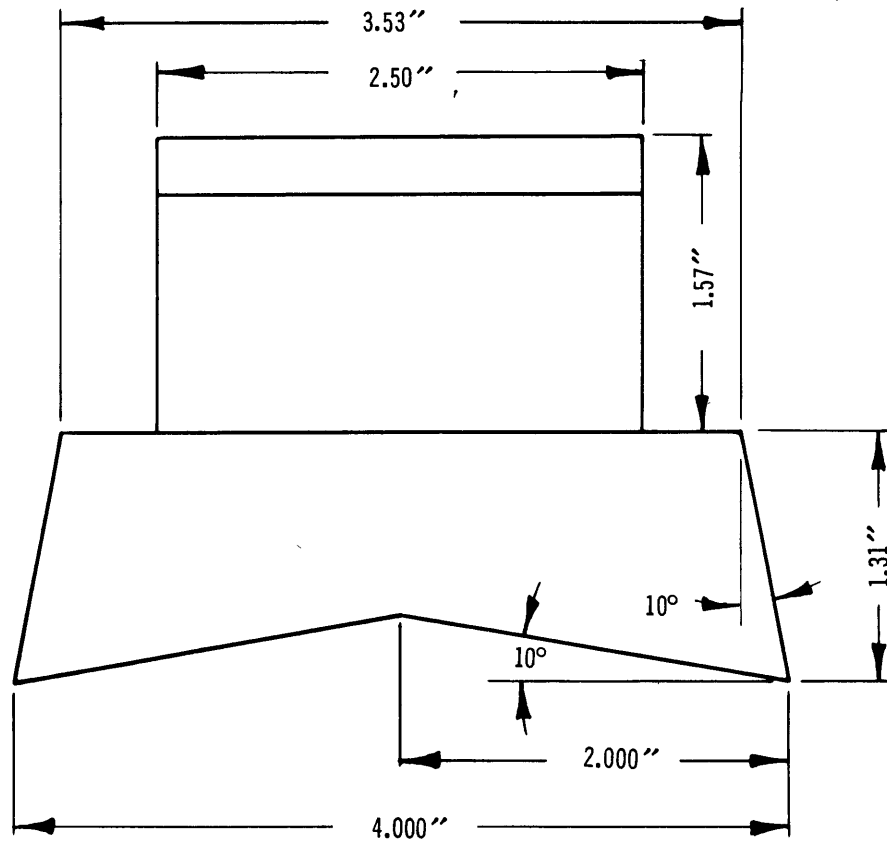
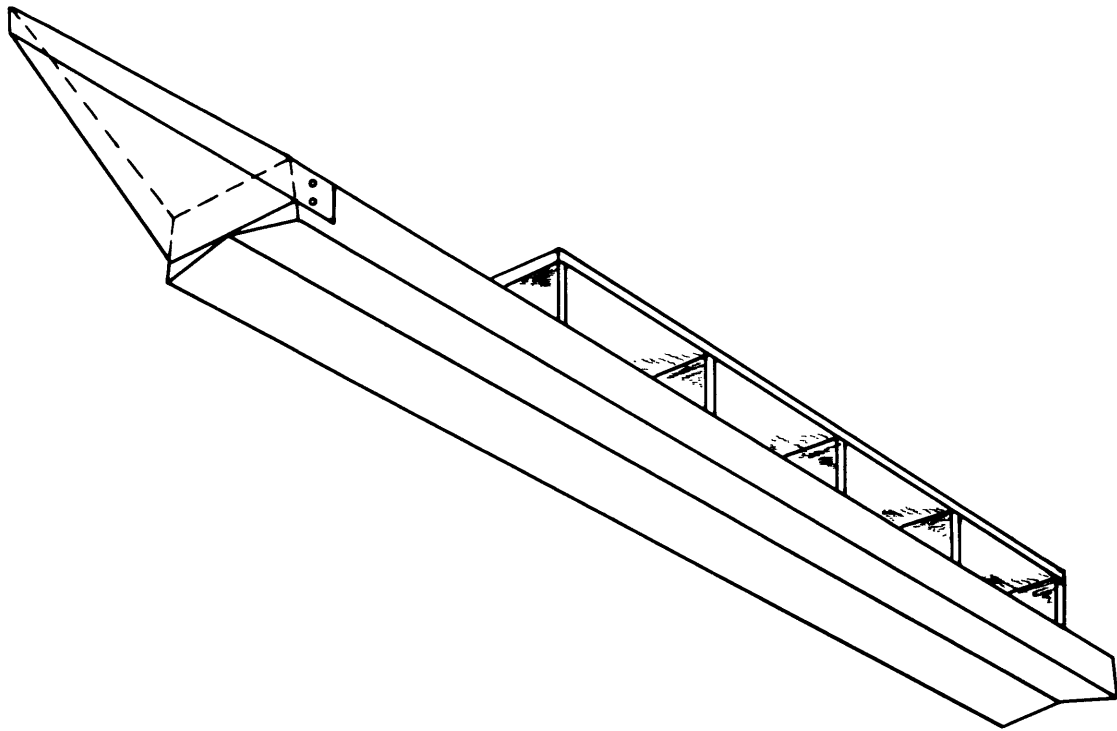

Figure 1 - Cross Section and Sketch of Model

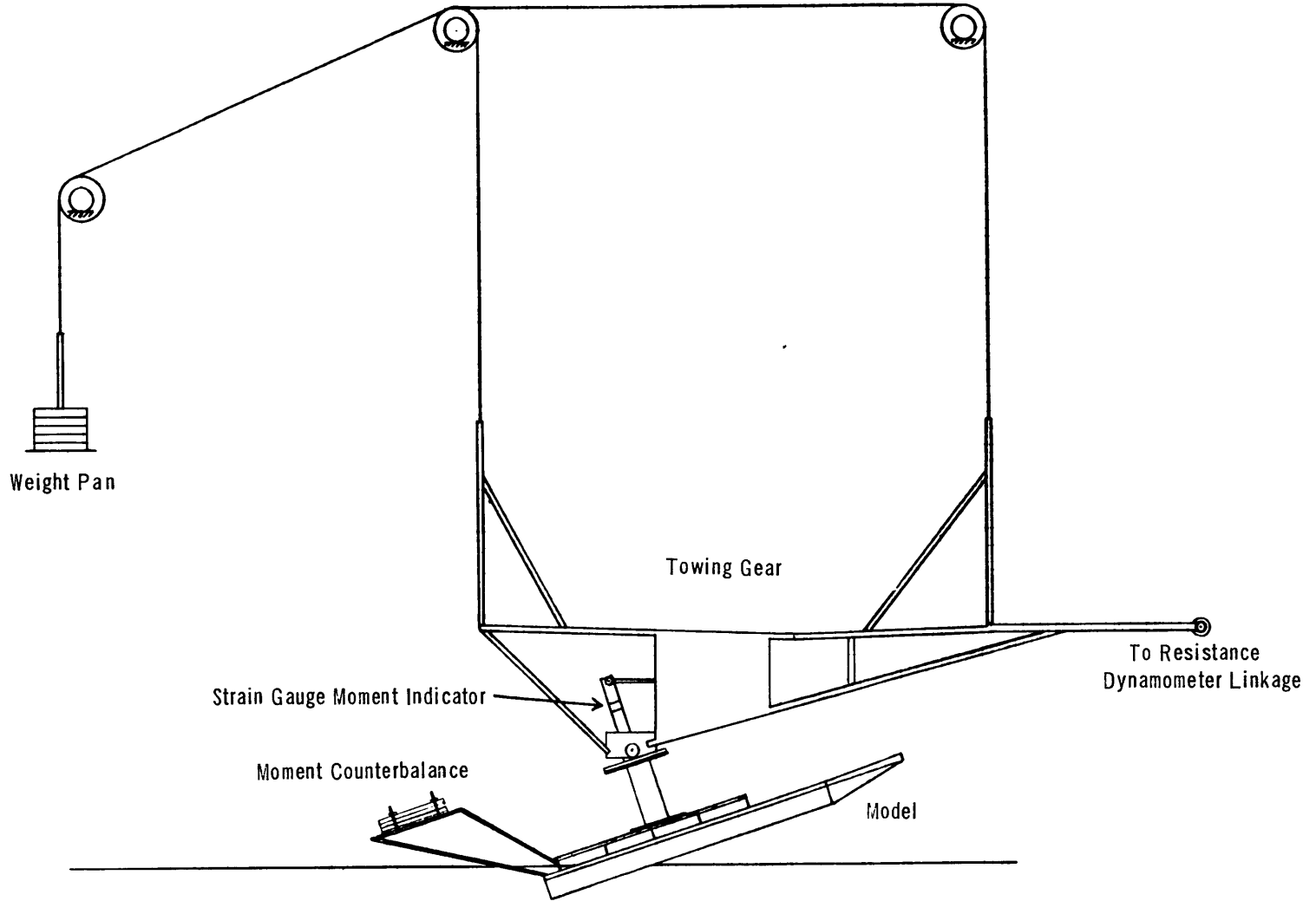

Figure 2 - Setup of Model and Towing Gear

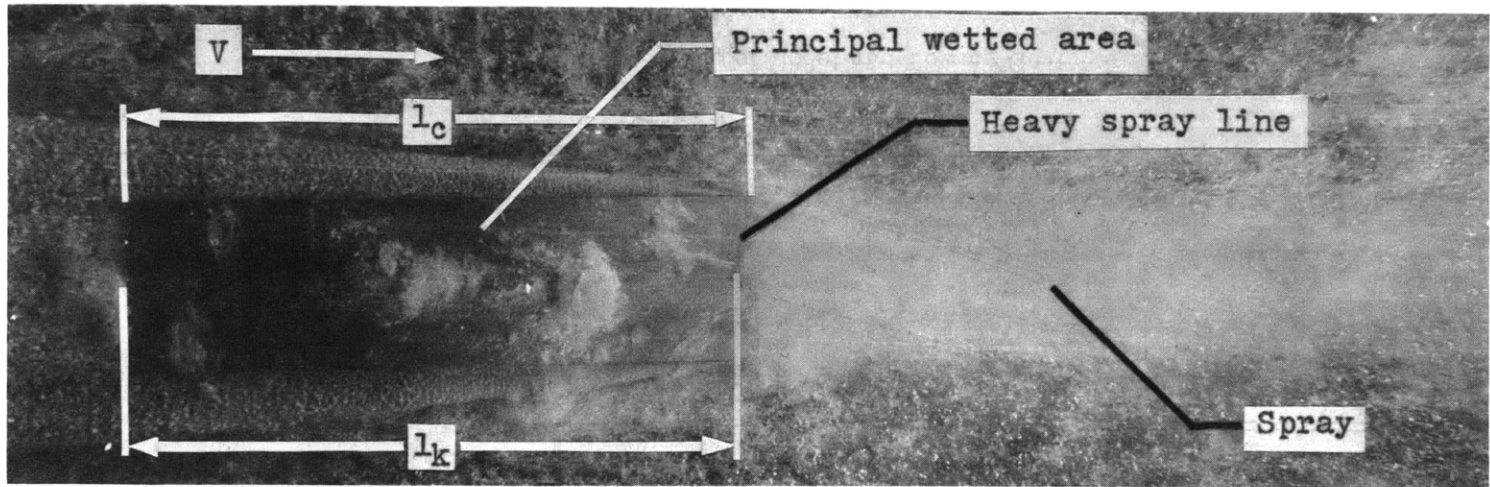

Figure 3a - Typical Photograph for Low Trim Angles Showing Air Bubbles Beneath Principal Wetted Area

14

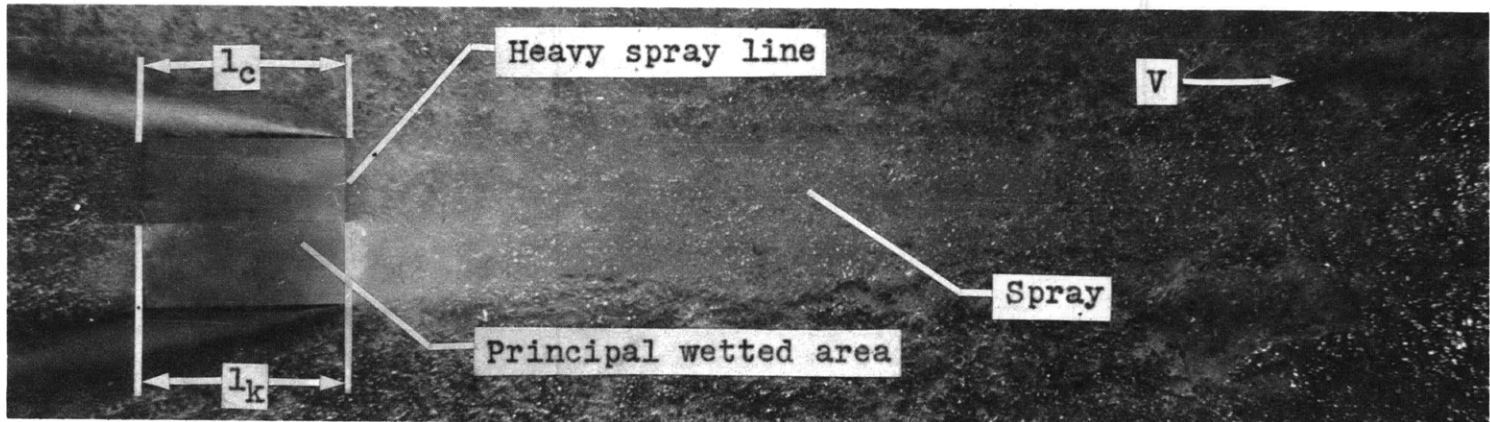

Figure 3b - Typical Photograph for High Trim Angles

Figure 3 - Typical Underwater Photographs

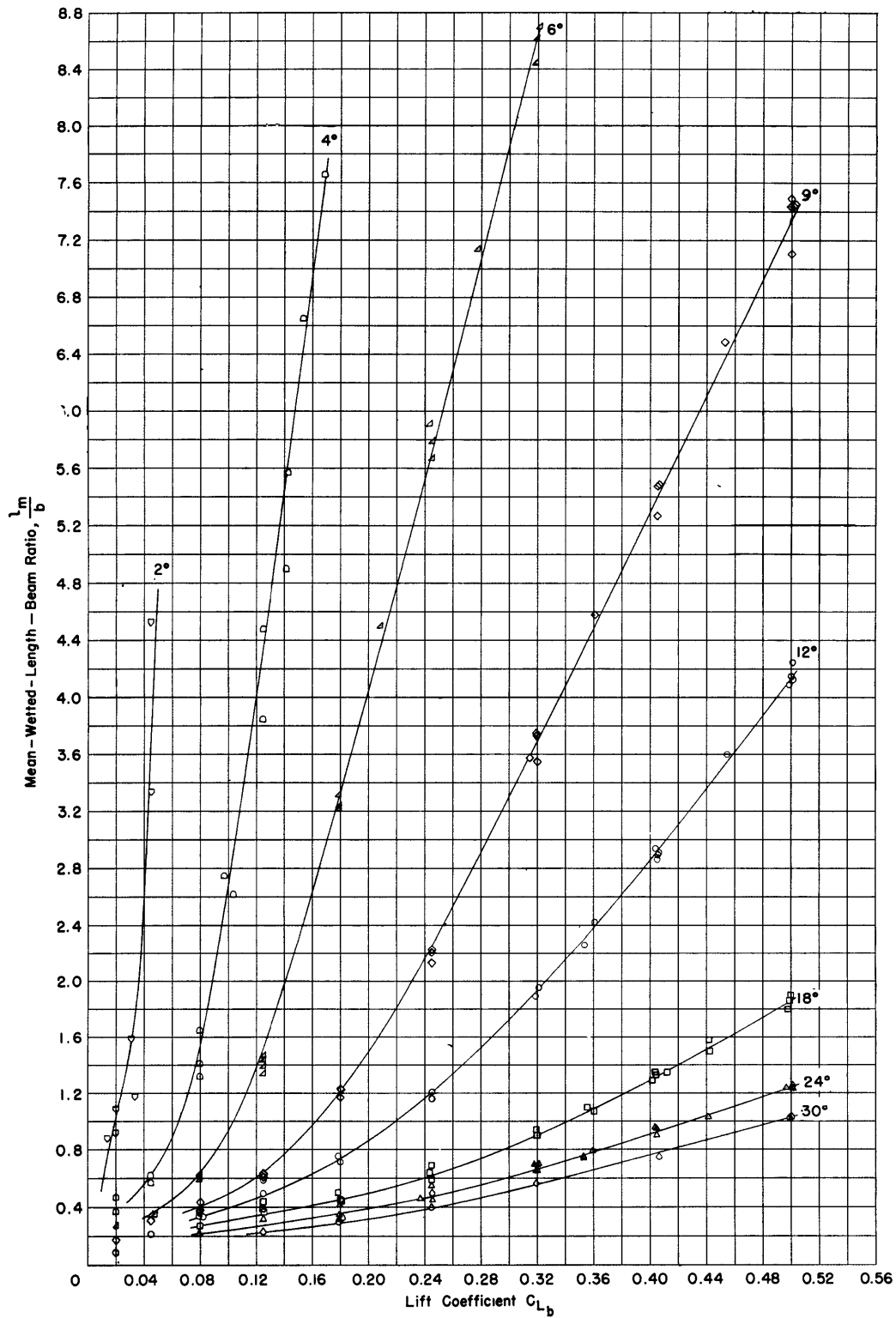

Figure 4 - Variation of Mean-Wetted-Length-Beam Ratio  $l_m/b$  with Lift Coefficient  $C_{Lb}$

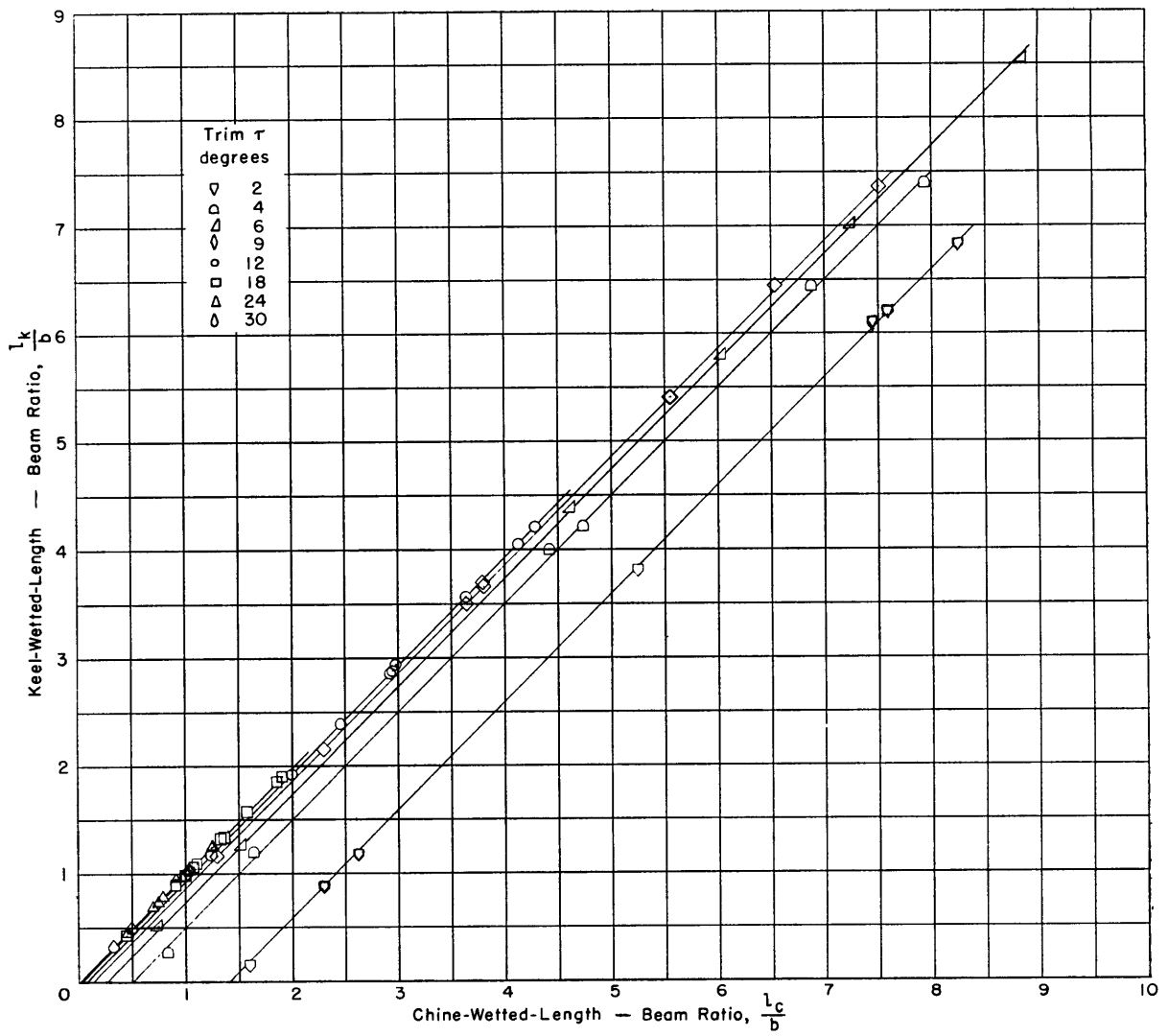

Figure 5 - Variation of Chine-Wetted-Length-Beam Ratio with Keel-Wetted-Length-Beam Ratio

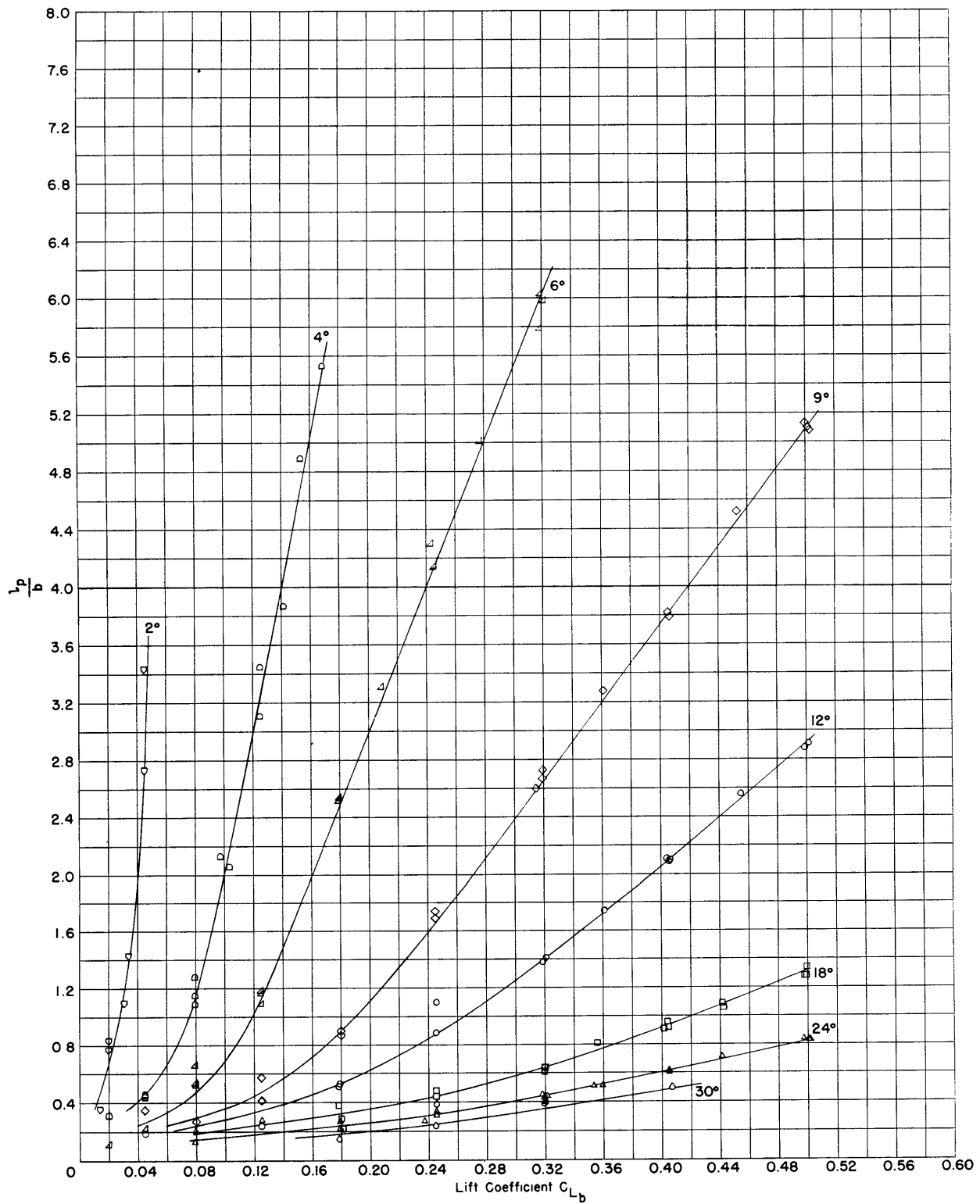

Figure 6 - Variation of Nondimensional Center-of-Pressure Location with Lift Coefficient

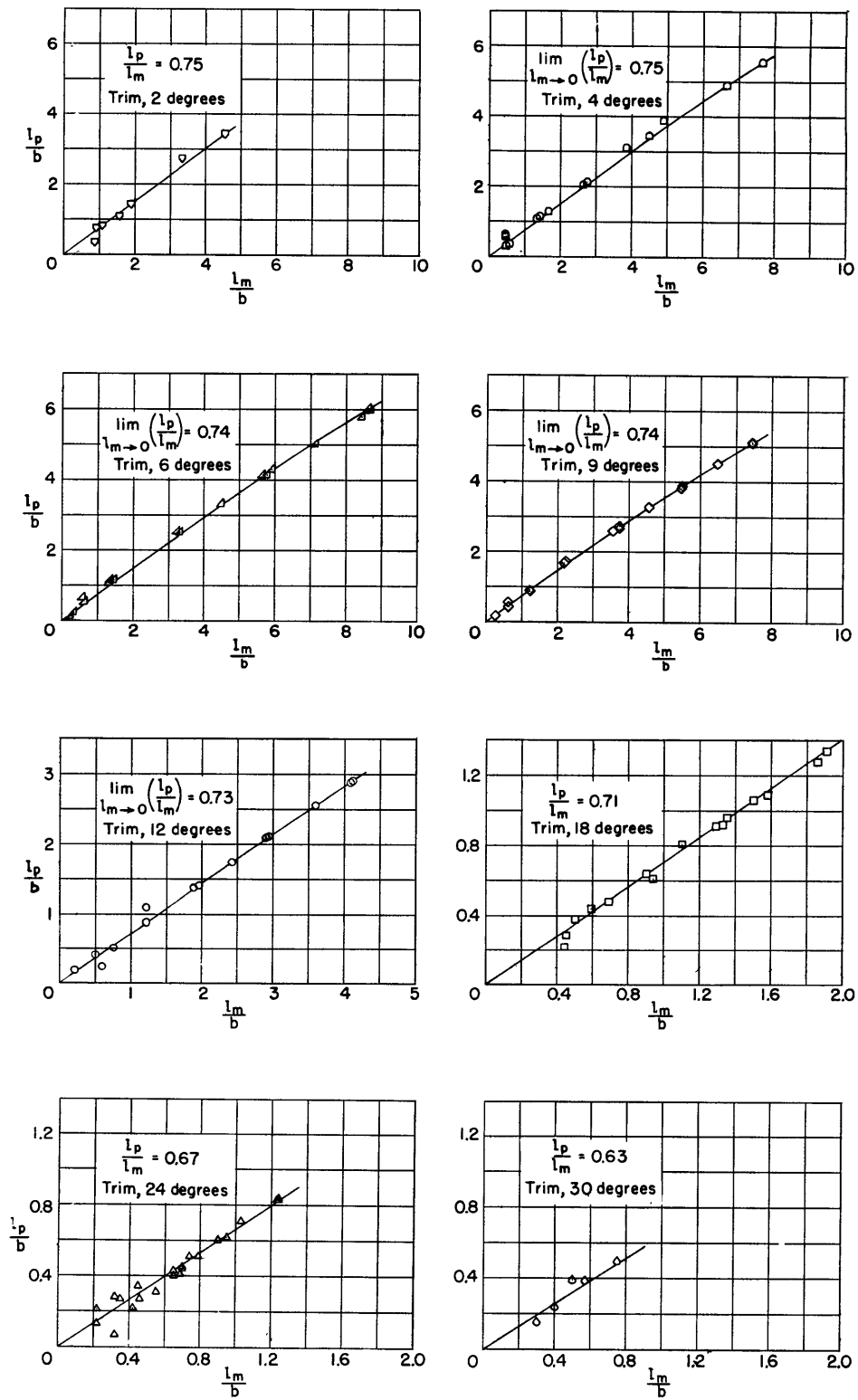

Figure 7 - Variation of Center-of-Pressure Ratio with Mean-Wetted-Length-Beam Ratio



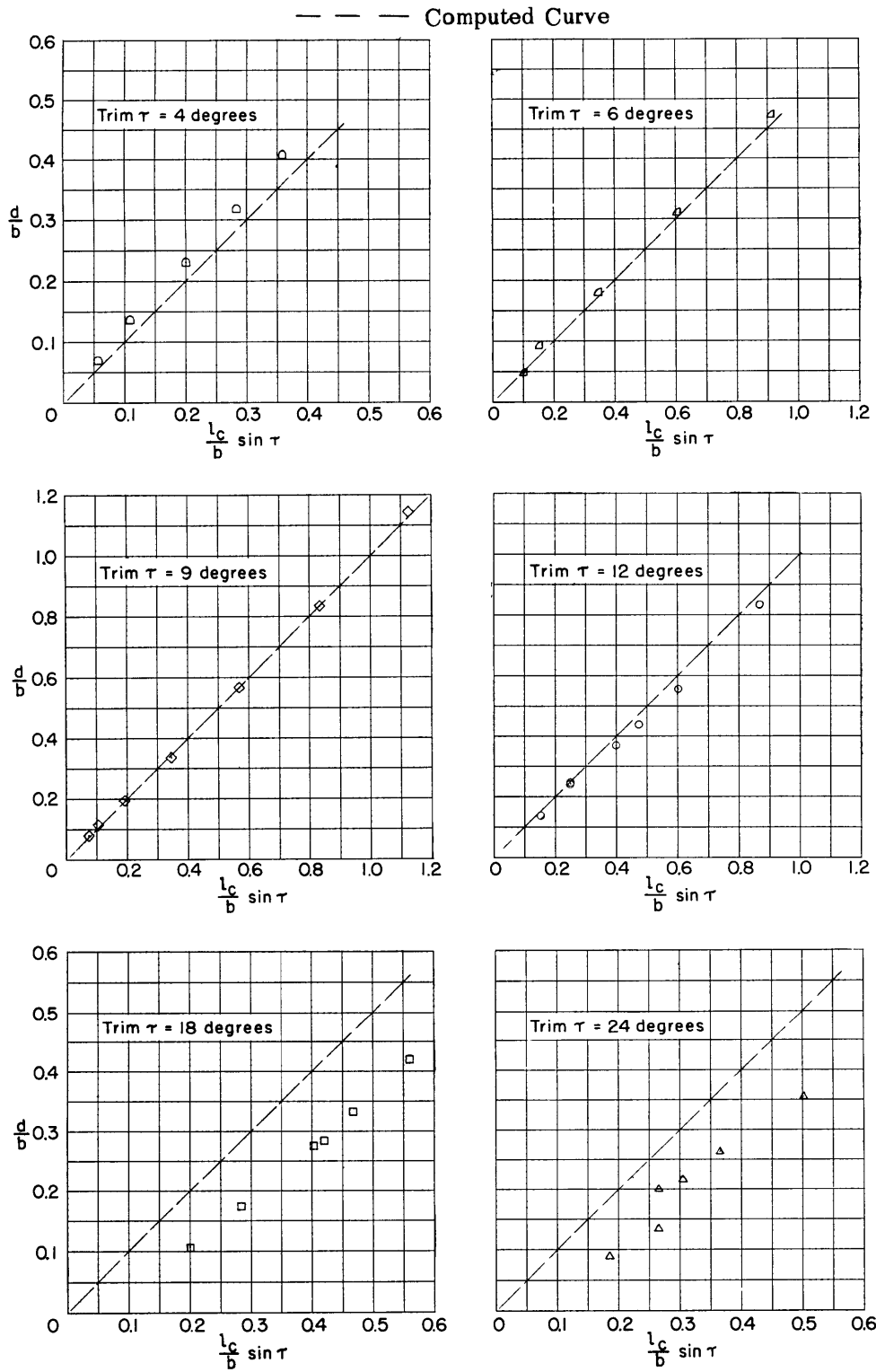

Figure 8 - Comparison of Experimental Draft Data with Computed Curve

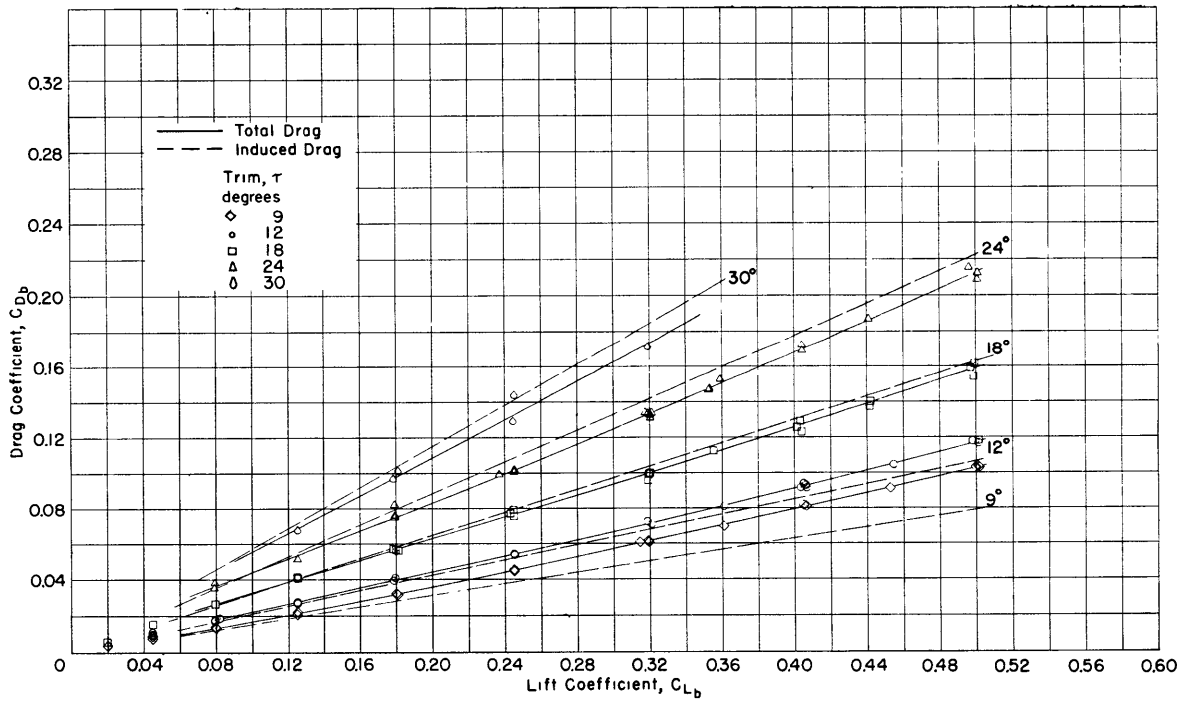
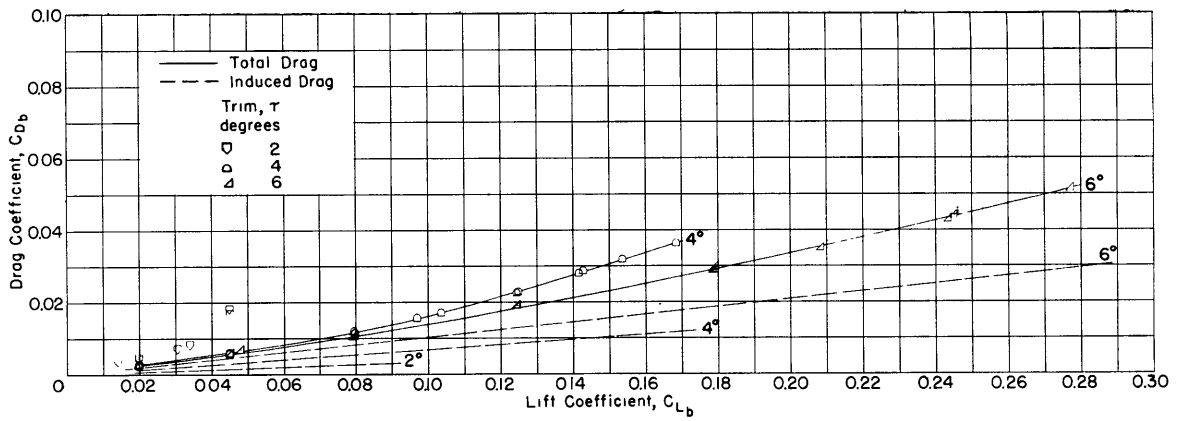

Figure 9 - Variation of Drag Coefficient with Lift Coefficient

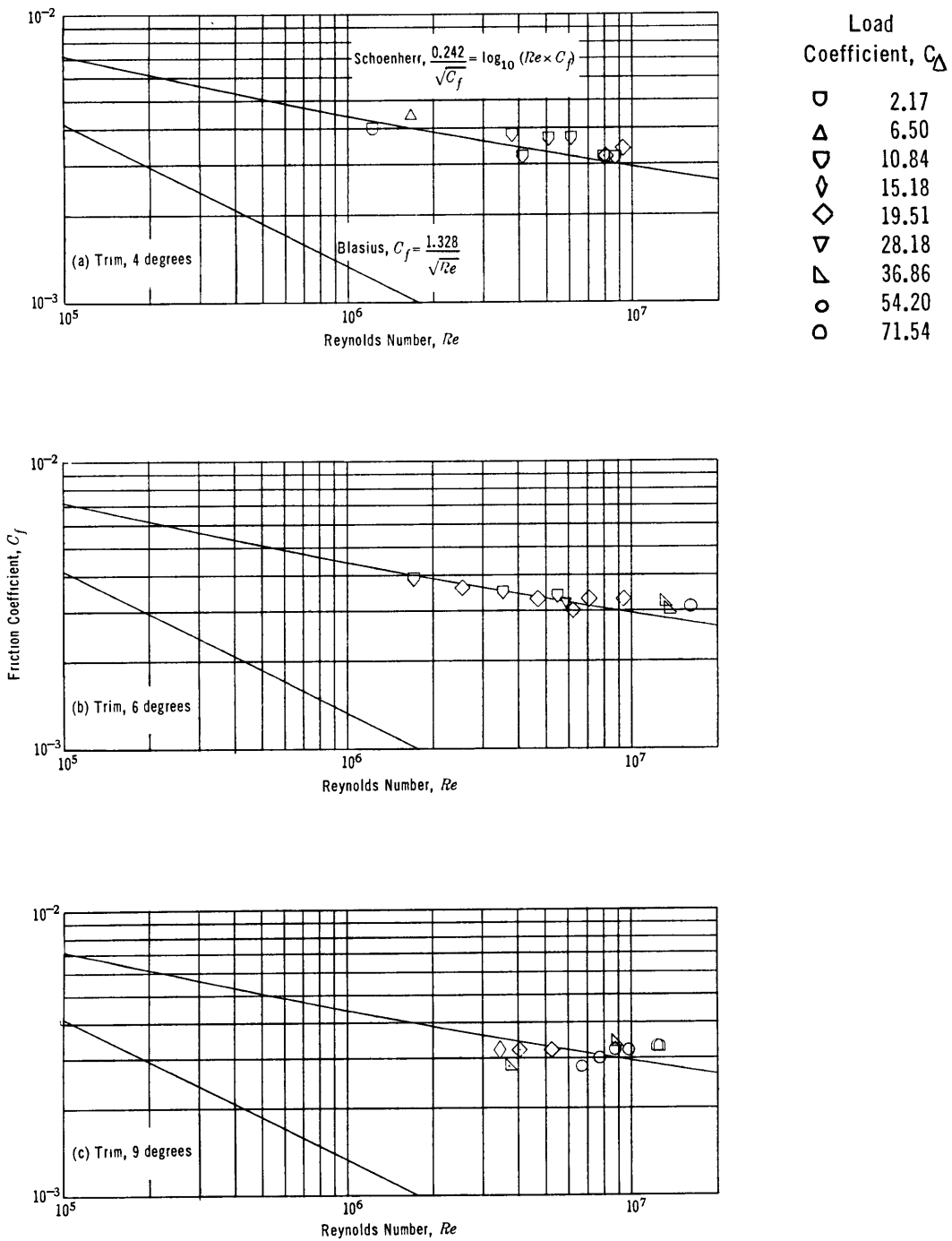

Figure 10 - Variation of Friction Coefficient with Reynolds Number



## INITIAL DISTRIBUTION

### Copies

- 3 DIR, Langley Aero Lab, Langley Field, Va.  
1 Mr. J.B. Parkinson, Chief, Hydro Div  
1 Mr. M.E. Hathaway
- 1 DIR of Aero Res, NACA, Washington, D.C.
- 3 CHONR, Mech Br (Code 438)
- 11 CHBUSHIPS, Library (Code 312)  
5 Tech Library  
1 Tech Asst to Chief (Code 106)  
1 Ship Des Div (Code 410)  
2 Prelim Des & Ship Protec (Code 420)  
1 Hull Des (Code 440)  
1 Boats and Small Craft (Code 452)
- 2 CHBUAER  
1 Aero & Hydro Br (Code AD-3)  
1 Res Div (Code RS-1)
- 9 DIR, USNRL, Tech Info Div (Code 2000)
- 1 CDR, USNOTS, Pasadena, Calif.
- 1 CDR, Philadelphia Naval Shipyard, Attn: Des Supt
- 1 Secy of the Air Force (Dir of Intelligence)  
Attn: Doc & Dissem Br (AFOIR-DD)
- 2 CG, Wright-Patterson AFB, Air Materiel Command,  
Air Documents Div (MCIDXE), Dayton, O.
- 1 Dr. J.H. Wayland, CIT, Pasadena, Calif.
- 1 Prof. Garrett Birkhoff, Dir, Dept of Math, Harvard Univ,  
Cambridge, Mass.
- 1 Dr. K.S.M. Davidson, Dir, ETT, SIT, Hoboken, N.J.
- 1 Dr. R.T. Knapp, Hydro Lab, CIT, Pasadena, Calif.
- 1 Dr. Hunter Rouse, Dir, Iowa Inst of Hydraulic Res,  
State Univ of Iowa, Iowa City, Ia.
- 1 Mr. Peter M. Kimon, c/o R.M. Cleveland, 50 Pequossette  
Rd, Belmont, Mass.
- 1 Engineering Societies Library, New York, N.Y.
- 1 SNAME, New York, N.Y.
- 1 Admin, Webb Inst of Nav Arch, Glen Cove, L.I., N.Y.
- 1 Dir, Exptl Nav Tank, University of Michigan, Ann Arbor,  
Mich.
- 1 Dir, Woods Hole Oceanographic Inst, Woods Hole, Mass.  
Attn: Mr. R.L. Rather
- 1 Head, Dept of NAME, MIT, Cambridge, Mass.
- 1 Dir, Hydraulic Lab, Newport News Shipbldg & Dry Dock  
Co, Newport News, Va.
- 1 Dynamic Developments, Inc, Seaplane Hangar, Babylon,  
L.I., N.Y. Attn: Mr. W.P. Carl, Jr.
- 1 Boeing Airplane Co, Seattle Div, Seattle, Wash.  
Attn: Mr. George Schairer
- 1 Chance-Vought Aircraft Div, United Aircraft Corp,  
Hensley Field, Dallas, Tex.
- 1 Consolidated-Vultee Aircraft Corp, General Offices,  
San Diego, Calif. Attn: Mr. E.G. Stout

### Copies

- 1 Curtiss-Wright Corp, Airplane Div, Columbus, O.
- 1 Douglas Aircraft Co, Inc., Santa Monica, Calif.  
Attn: Mr. A.E. Raymond
- 1 Mr. W.R. Ryan, VP in Charge of Engin, Edo Corp,  
College Point, L.I., N.Y.
- 1 The Grumman Aircraft Engin Corp, Bethpage, L.I.,  
N.Y. Attn: Mr. Leo Geyer
- 1 The Glenn L. Martin Co, Baltimore, Md.  
Attn: Mr. J.D. Pierson, Structural Dept
- 1 McDonnell Aircraft Corp, St. Louis, Mo.  
Attn: Mr. G.C. Covington
- 1 North American Aviation, Inc., Los Angeles, Calif.  
Attn: Mr. R.H. Rice
- 1 Northrop Aircraft, Inc., Northrop Field, Hawthorne,  
Calif. Attn: Mr. W.J. Cerny
- 1 Republic Aviation Corp, Farmingdale, L.I., N.Y.  
Attn: Mr. A.A. Kartveli
- 1 Sparkman & Stephens, Inc, New York, N.Y.
- 1 General Dynamics Corp, Electric Boat, Div,  
Groton, Conn.
- 1 Ventnor Boat Corp, Atlantic City, N.J.
- 1 RADM Roger E. Brard, Dir, Bassin d'Essais des  
Carenes, Paris (XVe) France
- 1 Dr. L. Malavard, Office, Natl d'Etudes et de Recherches  
Aeronautiques, Le Clerc, Chatillon, Paris, France
- 1 Gen. Ing. U. Pugliese, Pres, Istituto Nazionale per Studi  
ed Esperienze di Architettura Navale, Rome, Italy
- 1 Sr. M. Acevedo y Campoamor, Dir, Canal de Experiencias  
Hidrodinamicas, El Pardo, Madrid, Spain
- 1 Dr. J. Dreudonne, Dir, Inst de Recherches de la Construc  
Navale, Paris (9e) France
- 1 Dr. J.D. van Manen, Supt, Nederlandsh Scheepsbouwkundig  
Proefstation, Wageningen, The Netherlands
- 1 Prof. J.K. Lunde, Skipsmodelltanken, Tyholt Trondheim,  
Norway
- 1 Dr. Hans Edstrand, Dir, Statens Skeppsprovvningsanstalt,  
Goteborg c, Sweden
- 1 Dr. J.F. Allan, Supt, Ship Div, Natl Phys Lab, Teddington,  
Middlesex, England
- 1 Dr. H.W.E. Lerbs, Dir, Hamburg Model Basin, Hamburg,  
Germany
- 1 Supt, British Shipbldg Res Assn, London, England
- 8 ALUSNA, London, England
- 9 BJSM (NS)
- 3 CJS



MIT LIBRARIES

DUPL



3 9080 02754 2403

